



SIRIUS POSITION SWITCH METAL ENCLOSURE  
 56MM WIDE DEVICE CONNECTION 3X (M20X1.5)  
 1NO/ 1NC SNAP-ACTION CONTACTS ROTARY  
 ACTUATOR RIGHT/LEFT ADJUSTABLE, ROD  
 ACTUATOR PLASTIC 200MM LONG

Product designation		standard position switch
<b>Manufacturer article number</b>		
<ul style="list-style-type: none"> <li>• of the supplied basic switch</li> </ul>		<a href="#">3SE5122-0CA00</a>
<ul style="list-style-type: none"> <li>• of the supplied actuator head for position switches</li> </ul>		<a href="#">3SE5000-0AH00</a>
<ul style="list-style-type: none"> <li>• of the supplied operating lever</li> </ul>		<a href="#">3SE5000-0AA82</a>
<ul style="list-style-type: none"> <li>• of the supplied switching contacts</li> </ul>		<a href="#">3SE5000-0CA00</a>
<ul style="list-style-type: none"> <li>• of the supplied empty enclosure with cover</li> </ul>		<a href="#">3SE5122-0AA00</a>

General technical data:		
<b>Product function</b>		
<ul style="list-style-type: none"> <li>• positive opening</li> </ul>		No
<b>Insulation voltage</b>		
<ul style="list-style-type: none"> <li>• Rated value</li> </ul>	V	400
<b>Degree of pollution</b>		class 3
<b>Shock resistance</b>		30g / 11 ms
<b>Vibration resistance</b>		0.35 mm / 5g
<b>Surge voltage resistance Rated value</b>	kV	6
<b>Mechanical service life (switching cycles)</b>		
<ul style="list-style-type: none"> <li>• typical</li> </ul>		15 000 000
<b>Electrical endurance (switching cycles)</b>		
<ul style="list-style-type: none"> <li>• at AC-15 at 230 V typical</li> </ul>		100 000
<b>Electrical endurance (switching cycles) with contactor 3RH11, 3RT1016, 3RT1017, 3RT1024, 3RT1025, 3RT1026 typical</b>		10 000 000

Electrical operating cycles in one hour with contactor 3RH11, 3RT1016, 3RT1017, 3RT1024, 3RT1025, 3RT1026		6 000
Thermal current	A	6
Material of the enclosure of the switch head		metal
Protection class IP		IP65/IP67
Equipment marking		B
<ul style="list-style-type: none"> <li>• acc. to DIN EN 61346-2</li> <li>• acc. to DIN EN 81346-2</li> </ul>		B
Active principle		mechanical
Repeat accuracy	mm	0.05
Explosion protection category for dust		none
Explosion protection category for gas		none
Minimum actuating torque in activation direction	N·m	0.25
Operating current at AC-15		
<ul style="list-style-type: none"> <li>• at 230 V Rated value</li> <li>• at 400 V Rated value</li> </ul>	A	6
	A	4
Operating current		
<ul style="list-style-type: none"> <li>• at DC-13 at 125 V Rated value</li> <li>• at DC-13 at 400 V Rated value</li> </ul>	A	0.55
	A	0.1
Operating current		
<ul style="list-style-type: none"> <li>• at DC-13</li> <li>— at 24 V Rated value</li> </ul>	A	3

#### Enclosure:

Design of the housing		block, wide
Material of the enclosure		metal
Coating of the enclosure		cathodic immersion coating
Design of the housing acc. to standard		No

#### Drive Head:

Design of the operating mechanism		rod actuator, plastic, 200 mm long
Standard-compliant actuator head		EN 50041, design D
Shape of the switch head		roller

#### Connections/ Terminals:

Type of electrical connection		screw-type terminals
Type of connectable conductor cross-section		
<ul style="list-style-type: none"> <li>• solid</li> </ul>		1x (0.5 ... 1.5 mm <sup>2</sup> ), 2x (0.5 ... 0.75 mm <sup>2</sup> )
<ul style="list-style-type: none"> <li>• finely stranded with core end processing</li> </ul>		1x (0.5 ... 1.5 mm <sup>2</sup> ), 2x (0.5 ... 0.75 mm <sup>2</sup> )
<ul style="list-style-type: none"> <li>• finely stranded without core end processing</li> </ul>		1x (0.5 ... 1.5 mm <sup>2</sup> ), 2x (0.5 ... 0.75 mm <sup>2</sup> )
<ul style="list-style-type: none"> <li>• for AWG conductors</li> </ul>		
<ul style="list-style-type: none"> <li>— solid</li> </ul>		1x (20 ... 16), 2x (20 ... 18)
<ul style="list-style-type: none"> <li>— stranded</li> </ul>		1x (20 ... 16), 2x (20 ... 18)

#### Mechanical data:

**Cable entry type** 3 x (M20 x 1.5)

#### Communication/ Protocol:

**Design of the interface** without

#### Ambient conditions:

**Ambient temperature**





- during operation °C -25 ... +85
- during storage °C -40 ... +90

#### Installation/ mounting/ dimensions:

**mounting position** any

**Mounting type** screw fixing

#### Certificates/ approvals:

General Product Approval	Declaration of Conformity	Test Certificates	other		
 CSA	 UL		 EG-Konf.	<a href="#">Special Test Certificate</a>	<a href="#">Confirmation</a>

#### Further information

**Information- and Downloadcenter (Catalogs, Brochures,...)**

<http://www.siemens.com/industrial-controls/catalogs>

**Industry Mall (Online ordering system)**

<http://www.siemens.com/industrymall>

**Cax online generator**

<http://support.automation.siemens.com/WW/CAXorder/default.aspx?lang=en&mlfb=3SE51220CH82>

**Service&Support (Manuals, Certificates, Characteristics, FAQs,...)**

<http://support.automation.siemens.com/WW/view/en/3SE51220CH82/all>

**Image database (product images, 2D dimension drawings, 3D models, device circuit diagrams, EPLAN macros, ...)**

[http://www.automation.siemens.com/bilddb/cax\\_de.aspx?mlfb=3SE51220CH82&lang=en](http://www.automation.siemens.com/bilddb/cax_de.aspx?mlfb=3SE51220CH82&lang=en)

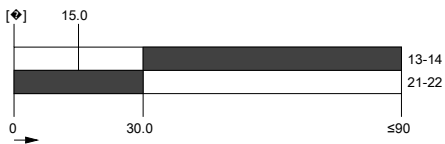
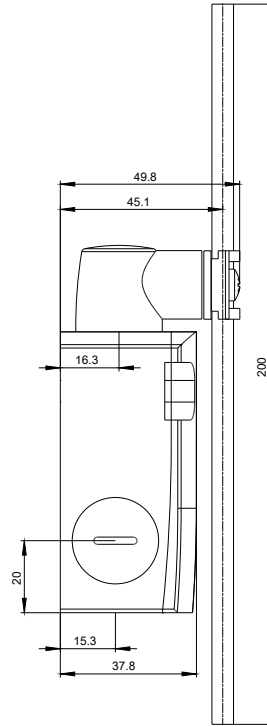
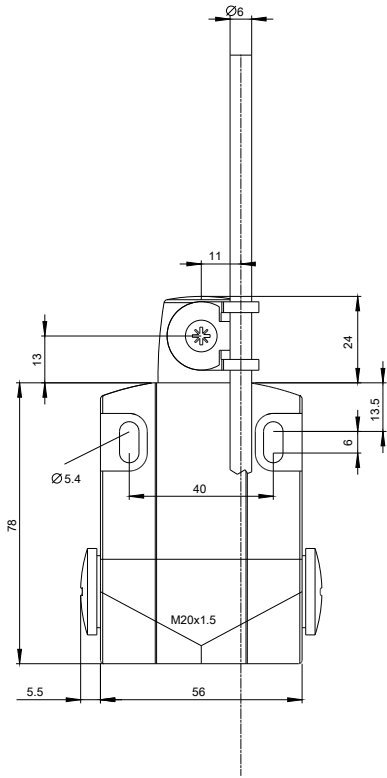

last modified:

09.03.2015