

Locating Pins · with ball end

22630.0530



Product Description

Ball ended locating pins facilitate easy inserting and removing avoiding clamping inclination.

Material

- Tool steel, hardened, blackened and ground

Drawing

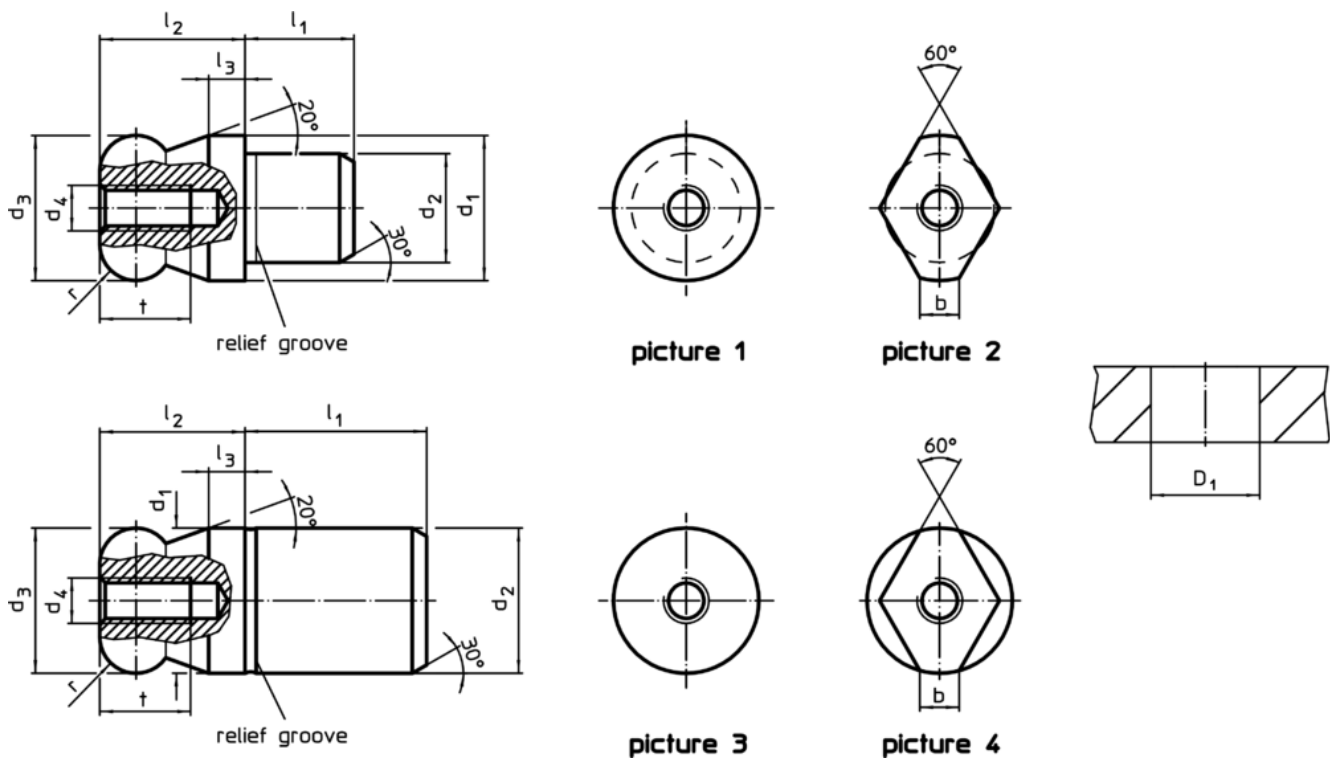

Order information

Dimensions										Location hole	[g]	Art. No.
d ₁	d ₂	d ₃	d ₄	l ₁	l ₂	l ₃	t	r	D ₁			
g6	n6	-0.01 -0.05								H7		
[mm]										[mm]		
with ball end plain, not stepped – picture 3, Tool steel												
30	30	30	M6	30	30	8	12	8		30	307	22630.0530

Application example



Compliance

RoHS compliant

Compliant according to Directive 2011/65/EU and Directive 2015/863

Does not contain SVHC substances

No SVHC substances with more than 0.1% w/w contained - SVHC list [REACH] as of 10.06.2022

Does not contain Proposition 65 substances

No Proposition 65 substances included
<https://www.P65Warnings.ca.gov/>

Free from Conflict Minerals

This product does not contain any substances designated as "conflict minerals" such as tantalum, tin, gold or tungsten from the Democratic Republic of Congo or adjacent countries.