

## Aluminium double bridge

eepos

### Application:

A double-girder crane is used where loads need to be distributed more evenly across multiple chassis and offers extended possibilities for attaching lifting devices.

### Execution:

- One set includes: 1 aluminium double girder crane with 4 profile closures, 4 hinge trolleys for connecting to the crane runway and 1 gap trolley for lifting equipment.

### Advantage:

- Ergonomic, effortless work
- Low noise emissions
- Smooth running
- Intelligent modular system with a wide range of accessories
- Ensures that the highest level of quality and profitability is retained

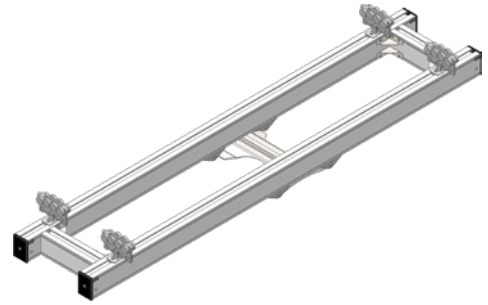

<b>Art. no.</b>	<b>77222 206</b>
<b>Brand</b>	EEPOS
<b>Manufacturer Part Number</b>	S1802230
<b>Load-carrying capacity</b>	500 kg
<b>Length</b>	3000 mm
<b>Weight</b>	88 kg
<b>Included in delivery</b>	1 set includes: 1 aluminium double girder crane with 4 profile end covers, 4 hinge trolleys to connect to the crane runway and 1 fork trolley 600 kg for lifting equipment
<b>Gross Weight</b>	88.000 kg
<b>Product Group</b>	786