

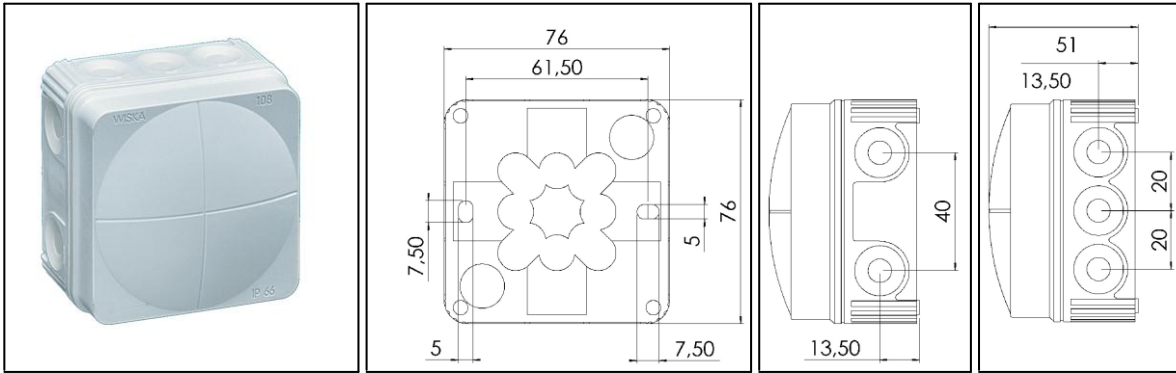





WISKA COMBI 108



Protection class to EN 60 529: IP 66
Flame protection: glow wire test 750° C acc. to EN 60695-2-11
Temperatures during installation: -5°C to 60°C
Temperature range of material: -30°C to 100°C, intermittent up to approx. 120°C
Voltage: 400 V
Material: Polypropylene, reinforced glass fibre; sealing: thermoplastic elastomere
Terminals/poles: 2,5 mm²
Fixing: With mounting clip for snap-on fixing or 2 internal openings outside of the sealing area
Equipment: 10 elastic self-sealing membranes for cable entry without mechanical devices at the side and 2 in the base
 - Colour RAL 7035 light grey
 - .../S = black
 - .../W = white

Type	WISKA-No.		 mm		L x B x H external / open mm
COMBI 108/5	10060523	10/100	3 - 14		76 x 76 x 51
COMBI 108/5/S	10061998	10/100	3 - 14		76 x 76 x 51
COMBI 108/5/W	10060623	10/100	3 - 14		76 x 76 x 51