

M8 FEMALE 90° LED

PUR 3x0.25 GRAY, 3m

M8

Female 90°

3-pole with 2 × LED (PNP)

Plastic housings with good resistance against chemicals and oils. The resistance to aggressive media should be individually tested for your application. Further details on request. Further cable lengths on request.

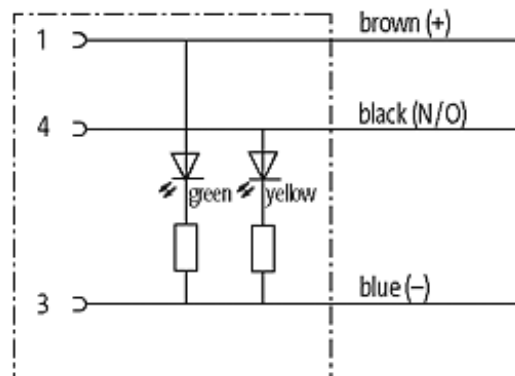
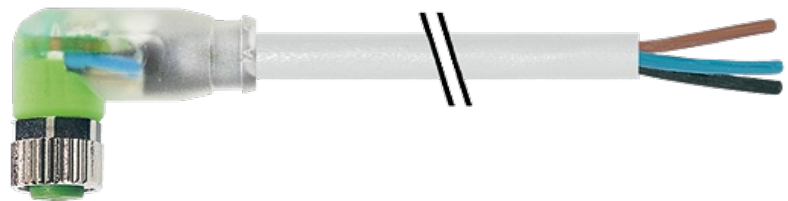
[Link to Product](#)**Illustration**

Female

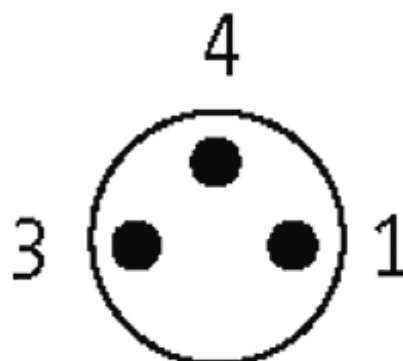



Product may differ from Image

Approvals



* only for products with UL/CSA approved cable

Form

08121

Technical Data

Operating voltage	24 V DC $\pm 25\%$
Operating current per contact	max. 4 A
Locking of ports	Screw thread M8 \times 1 mm (recommended torque 0.4 Nm) self-securing
Protection	IP67 inserted and tightened (EN 60529)

Cables

Cable number	220
No./diameter of wires	3 \times 0.25 mm ²
Wire isolation	PVC (br, bl, bk)
C-track properties	2 Mio.
Jacket Color	gray
Shore hardness outer jacket	85 \pm 5A
Material (jacket)	PUR/PVC (UL/CSA)
Outer diameter	approx. 4.5 mm
Bend radius (fixed)	10 \times outer \varnothing
Bend radius (moving)	15 \times outer \varnothing
Temperature range (fixed)	-30...+80 °C

The information in this brochure has been compiled with the utmost care.

Liability for the correctness completeness and topicality of the information is restricted to gross negligence. Version: 05/15

Temperature range (mobile)	-5...+80 °C
----------------------------	-------------

General data

Temperature range	-25...+85 °C, depending on cable quality
-------------------	--

Commercial data

country of origin	DE
-------------------	----

customs tariff number	85444290
-----------------------	----------

minimum order quantity	1
------------------------	---