

P10

Werkstattwagen

mit 262 Werkzeugen für 5 Schubladen

810.5262

Werkstattwagen P10

mit 8 Schubladen

873.0008

DAS EINSTIEGSMODELL FÜR HOHE ANSPRÜCHE



P10

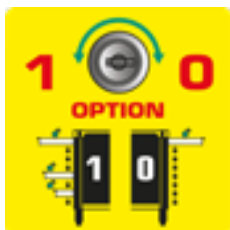

DUO Lock geniale Verschlusstechnik



8 Schubladen jeweils bis zu 50 kg belastbar



Stabiles **Kugellager**



Edelstahloberfläche



Schloss abschließbar



Antistatische Rollen mit Bremse



Integrierter **Kantenschutz**



Inklusive **Papierrollenhalter**



Inklusive **Dosenhalter**

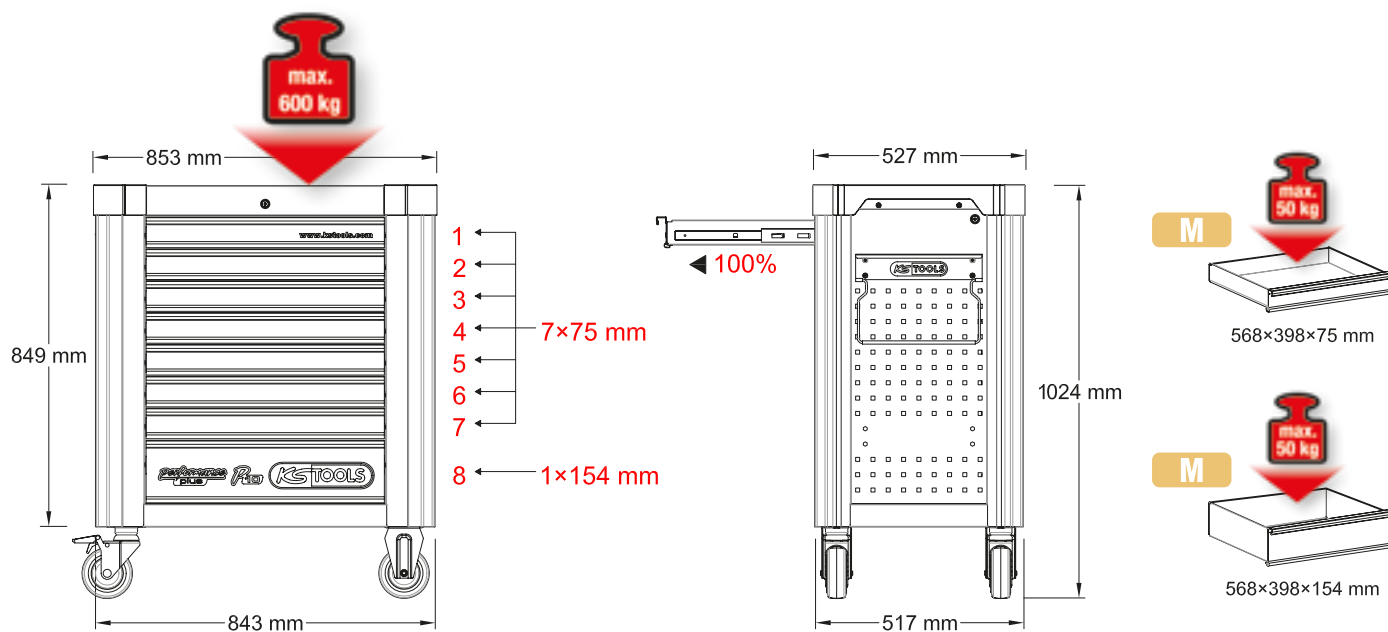

P10 Werkstattwagen

mit 262 Werkzeugen für 5 Schubladen

810.5262



M

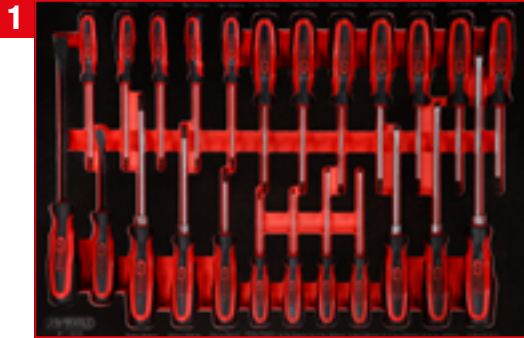

Schraubendreher-Satz

811.0024

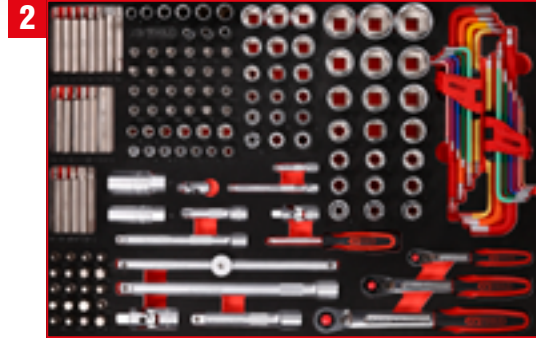

1/4" + 3/8" + 1/2" Steckschlüssel-Satz

811.0159

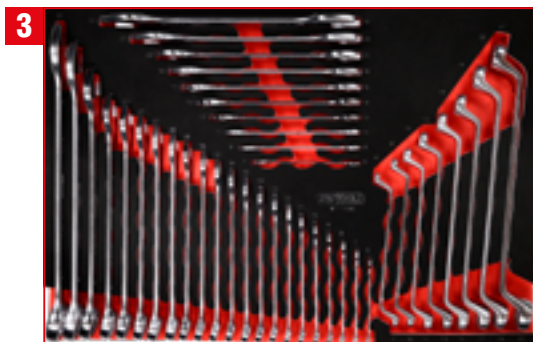

Schraubenschlüssel-Satz

811.1040

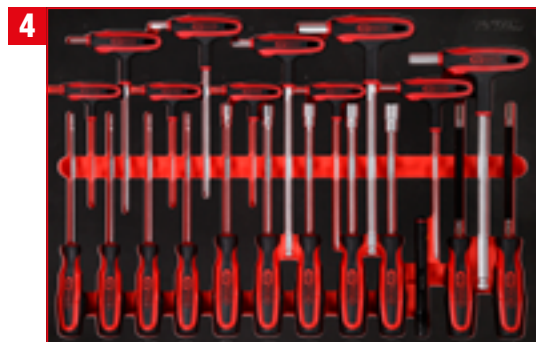

T-Griff- und Schraubendreher-Satz

811.1022



Zangen- / Hammer- / und Meißel-Satz

811.0017

811.0024

M Schraubendreher-Satz

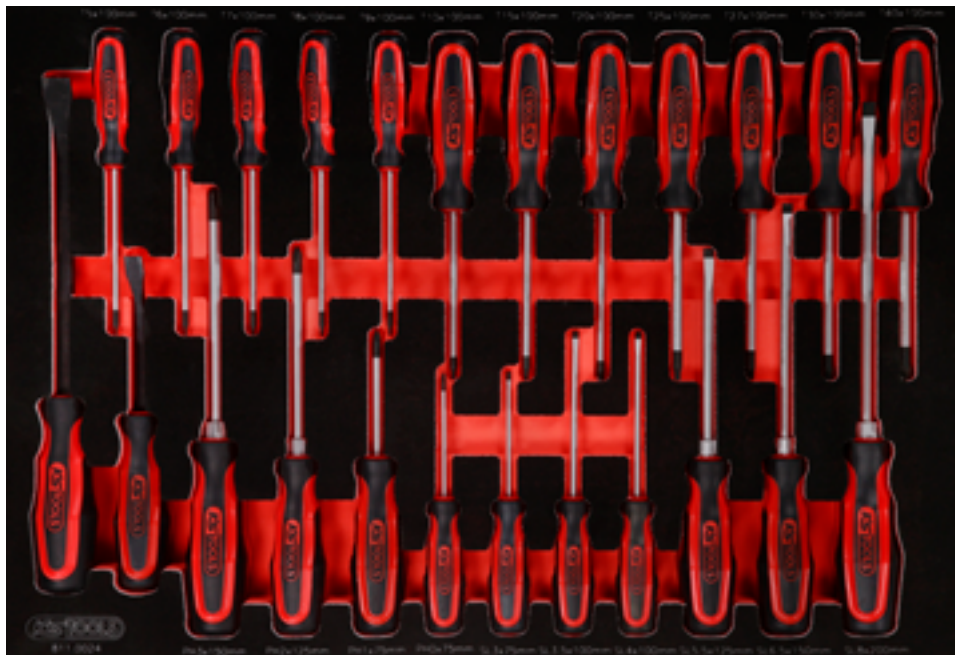

Pos.	Code	Bezeichnung	Teiligkeit
1	911.8102	Hebeleisen, 15 x 185 mm	1
2	911.8101	Hebeleisen, 11 x 115 mm	1
3	159.1133	ERGOTORQUEplus Schraubendreher, T5	1
4	159.1134	ERGOTORQUEplus Schraubendreher, T6	1
5	159.1135	ERGOTORQUEplus Schraubendreher, T7	1
6	159.1030	ERGOTORQUEplus Schraubendreher, T8	1
7	159.1031	ERGOTORQUEplus Schraubendreher, T9	1
8	159.1032	ERGOTORQUEplus Schraubendreher, T10	1
9	159.1033	ERGOTORQUEplus Schraubendreher, T15	1
10	159.1034	ERGOTORQUEplus Schraubendreher, T20	1
11	159.1035	ERGOTORQUEplus Schraubendreher, T25	1
12	159.1036	ERGOTORQUEplus Schraubendreher, T27	1
13	159.1037	ERGOTORQUEplus Schraubendreher, T30	1
14	159.1038	ERGOTORQUEplus Schraubendreher, T40	1
15	159.1024	ERGOTORQUEplus Schraubendreher, PH3, 265 mm	1
16	159.1022	ERGOTORQUEplus Schraubendreher, PH2, 230 mm	1
17	159.1020	ERGOTORQUEplus Schraubendreher, PH1, 180 mm	1
18	159.1027	ERGOTORQUEplus Schraubendreher, PH0, 155 mm	1
19	159.1002	ERGOTORQUEplus Schlitz-Schraubendreher, 3 mm, 155 mm lang	1
20	159.1112	ERGOTORQUEplus Schlitz-Schraubendreher, 3,5 mm, 180 mm lang	1
21	159.1004	ERGOTORQUEplus Schlitz-Schraubendreher, 4 mm, 180 mm lang	1
22	159.1006	ERGOTORQUEplus Schlitz-Schraubendreher, 5,5 mm, 230 mm lang	1
23	159.1009	ERGOTORQUEplus Schlitz-Schraubendreher, 6,5 mm, 255 mm lang	1
24	159.1011	ERGOTORQUEplus Schlitz-Schraubendreher, 8 mm, 315 mm lang	1

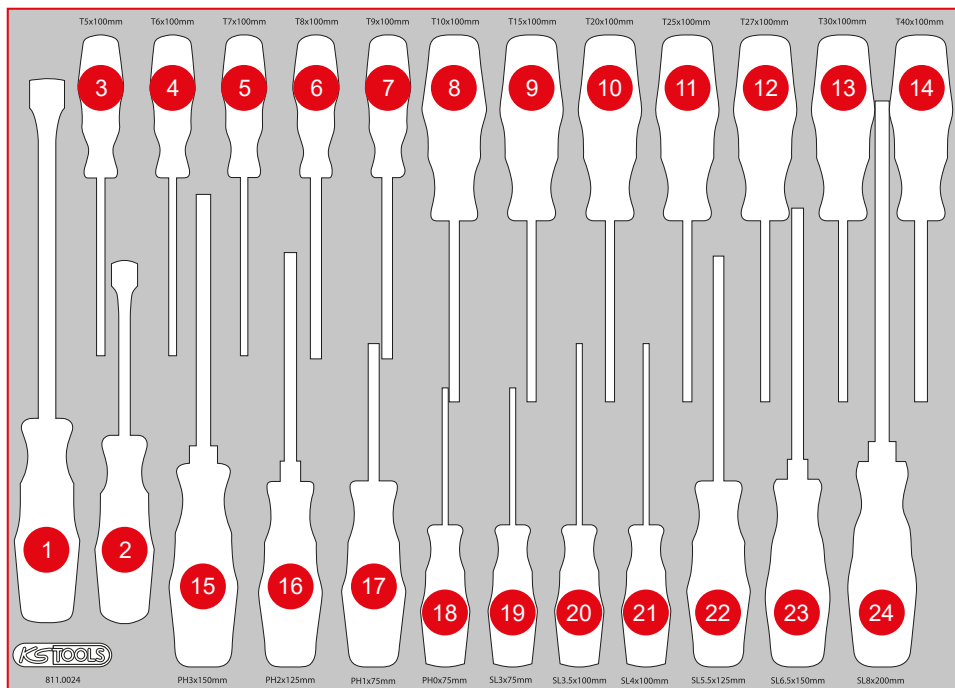

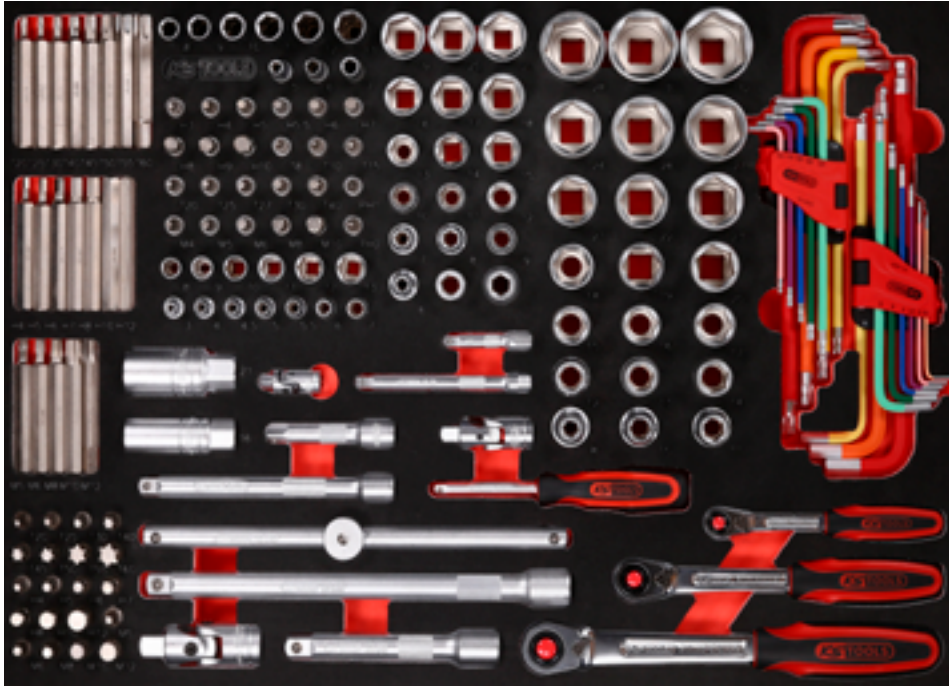
M 1/4" + 3/8" + 1/2" Steckschlüssel-Satz



Pos.	Code	Bezeichnung	Teilligkeit	Pos.	Code	Bezeichnung	Teilligkeit	Pos.	Code	Bezeichnung	Teilligkeit
1	975.2020	10 mm Bit Torx, 75 mm, T20	1	26	930.2050	10 mm Bit Torx, 30 mm, T50	1	51	911.1437	1/4" Bit-Stecknuss Innensechskant, 4 mm	1
2	975.2025	10 mm Bit Torx, 75 mm, T25	1	27	930.2055	10 mm Bit Torx, 30 mm, T55	1	52	911.1438	1/4" Bit-Stecknuss Innensechskant, 5 mm	1
3	975.2030	10 mm Bit Torx, 75 mm, T30	1	28	930.2060	10 mm Bit Torx, 30 mm, T60	1	53	911.14385	1/4" Bit-Stecknuss Innensechskant, 5,5 mm	1
4	975.2040	10 mm Bit Torx, 75 mm, T40	1	29	930.1004	10 mm Bit Innensechskant, 30 mm, 4 mm	1	54	911.1439	1/4" Bit-Stecknuss Innensechskant, 6 mm	1
5	975.2045	10 mm Bit Torx, 75 mm, T45	1	30	930.1005	10 mm Bit Innensechskant, 30 mm, 5 mm	1	55	911.1440	1/4" Bit-Stecknuss Innensechskant, 7 mm	1
6	975.2050	10 mm Bit Torx, 75 mm, T50	1	31	930.1006	10 mm Bit Innensechskant, 30 mm, 6 mm	1	56	911.1441	1/4" Bit-Stecknuss Innensechskant, 8 mm	1
7	975.2055	10 mm Bit Torx, 75 mm, T55	1	32	930.1007	10 mm Bit Innensechskant, 30 mm, 7 mm	1	57	917.1454	1/4" Bit-Stecknuss Innensechskant, 9 mm	1
8	975.2060	10 mm Bit Torx, 75 mm, T60	1	33	930.1008	10 mm Bit Innensechskant, 30 mm, 8 mm	1	58	917.1452	1/4" Bit-Stecknuss Innensechskant, 10 mm	1
9	975.1004	10 mm Bit Innensechskant, 75 mm, 4 mm	1	34	930.1010	10 mm Bit Innensechskant, 30 mm, 10 mm	1	59	911.1448	1/4" Bit-Stecknuss Torx, T8	1
10	975.1005	10 mm Bit Innensechskant, 75 mm, 5 mm	1	35	930.1012	10 mm Bit Innensechskant, 30 mm, 12 mm	1	60	911.1442	1/4" Bit-Stecknuss Torx, T10	1
11	975.1006	10 mm Bit Innensechskant, 75 mm, 6 mm	1	36	930.3005	10 mm Bit XZN, 30 mm, M5	1	61	911.1443	1/4" Bit-Stecknuss Torx, T15	1
12	975.1007	10 mm Bit Innensechskant, 75 mm, 7 mm	1	37	930.3006	10 mm Bit XZN, 30 mm, M6	1	62	911.1444	1/4" Bit-Stecknuss Torx, T20	1
13	975.1008	10 mm Bit Innensechskant, 75 mm, 8 mm	1	38	930.3008	10 mm Bit XZN, 30 mm, M8	1	63	911.1445	1/4" Bit-Stecknuss Torx, T25	1
14	975.1010	10 mm Bit Innensechskant, 75 mm, 10 mm	1	39	930.3010	10 mm Bit XZN, 30 mm, M10	1	64	911.1449	1/4" Bit-Stecknuss Torx, T27	1
15	975.1012	10 mm Bit Innensechskant, 75 mm, 12 mm	1	40	930.3012	10 mm Bit XZN, 30 mm, M12	1	65	911.1446	1/4" Bit-Stecknuss Torx, T30	1
16	975.3005	10 mm Bit XZN, 75 mm, M5	1	41	917.1428	1/4" Sechskant-Stecknuss, lang, 8 mm	1	66	911.1447	1/4" Bit-Stecknuss Torx, T40	1
17	975.3006	10 mm Bit XZN, 75 mm, M6	1	42	917.1429	1/4" Sechskant-Stecknuss, lang, 9 mm	1	67	911.1415	1/4" Bit-Stecknuss, PH1	1
18	975.3008	10 mm Bit XZN, 75 mm, M8	1	43	917.1430	1/4" Sechskant-Stecknuss, lang, 10 mm	1	68	917.1541	1/4" Bit-Stecknuss XZN, M4	1
19	975.3010	10 mm Bit XZN, 75 mm, M10	1	44	917.1431	1/4" Sechskant-Stecknuss, lang, 11 mm	1	69	917.1542	1/4" Bit-Stecknuss XZN, M5	1
20	975.3012	10 mm Bit XZN, 75 mm, M12	1	45	917.1432	1/4" Sechskant-Stecknuss, lang, 12 mm	1	70	917.1543	1/4" Bit-Stecknuss XZN, M6	1
21	930.2020	10 mm Bit Torx, 30 mm, T20	1	46	917.1433	1/4" Sechskant-Stecknuss, lang, 13 mm	1	71	917.1545	1/4" Bit-Stecknuss XZN, M8	1
22	930.2025	10 mm Bit Torx, 30 mm, T25	1	47	917.1527	1/4" Sechskant-Stecknuss, lang, 5 mm	1	72	917.1546	1/4" Bit-Stecknuss XZN, M10	1
23	930.2030	10 mm Bit Torx, 30 mm, T30	1	48	917.1426	1/4" Sechskant-Stecknuss, lang, 6 mm	1	73	911.1416	1/4" Bit-Stecknuss, PH2	1
24	930.2040	10 mm Bit Torx, 30 mm, T40	1	49	917.1427	1/4" Sechskant-Stecknuss, lang, 7 mm	1	74	917.1408	1/4" Sechskant-Stecknuss, 8 mm	1
25	930.2045	10 mm Bit Torx, 30 mm, T45	1	50	911.1436	1/4" Bit-Stecknuss Innensechskant, 3 mm	1	75	917.1409	1/4" Sechskant-Stecknuss, 9 mm	1

811.1040

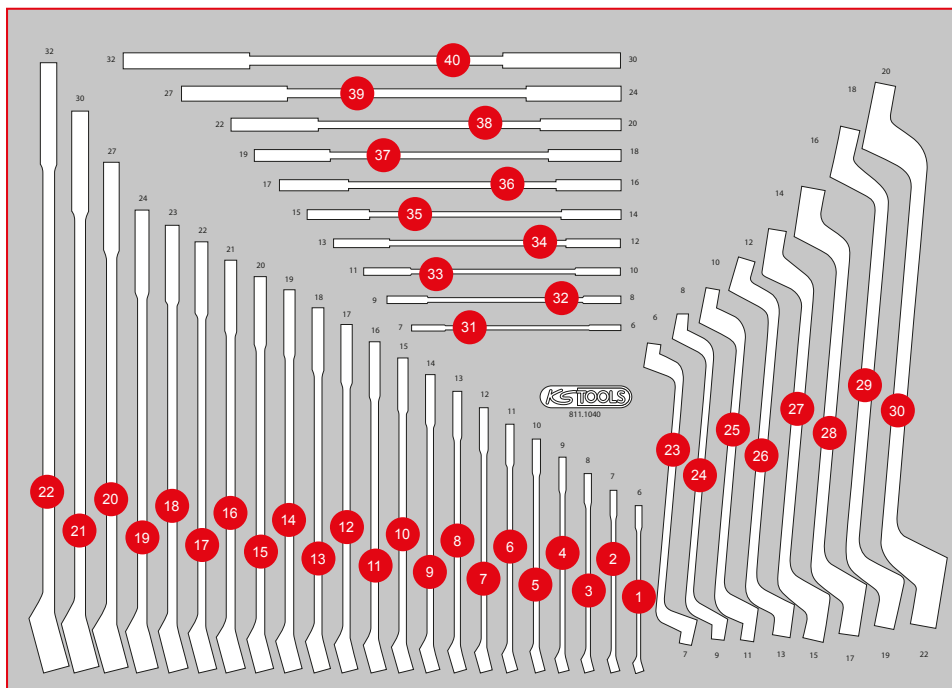
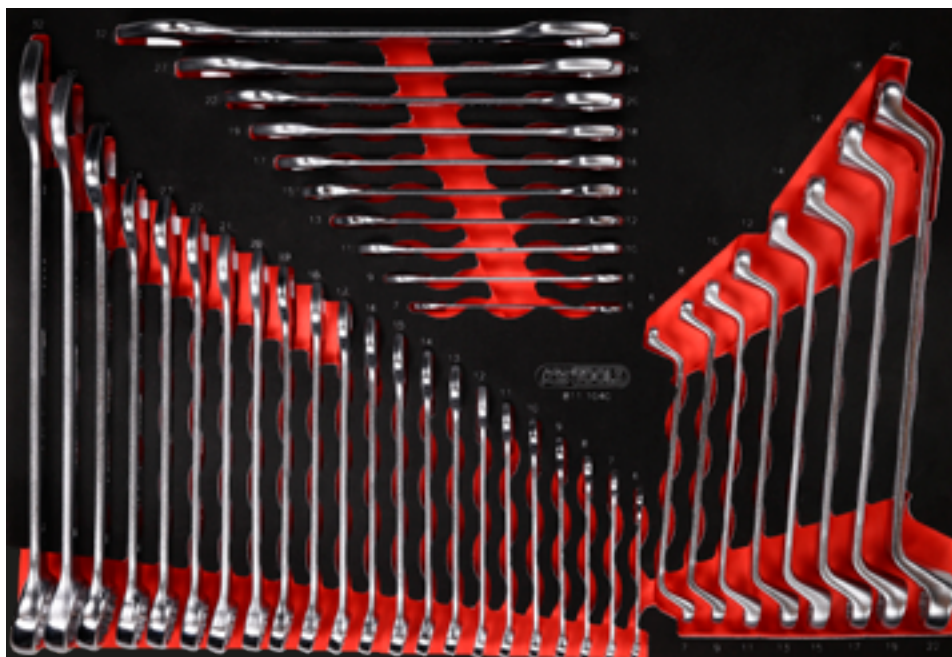
M Schraubenschlüssel-Satz



Pos.	Code	Bezeichnung	Teiligkeit
1	517.0606	Ringmaulschlüssel, abgewinkelt, 6 mm	1
2	517.0607	Ringmaulschlüssel, abgewinkelt, 7 mm	1
3	517.0608	Ringmaulschlüssel, abgewinkelt, 8 mm	1
4	517.0609	Ringmaulschlüssel, abgewinkelt, 9 mm	1
5	517.0610	Ringmaulschlüssel, abgewinkelt, 10 mm	1
6	517.0611	Ringmaulschlüssel, abgewinkelt, 11 mm	1
7	517.0612	Ringmaulschlüssel, abgewinkelt, 12 mm	1
8	517.0613	Ringmaulschlüssel, abgewinkelt, 13 mm	1
9	517.0614	Ringmaulschlüssel, abgewinkelt, 14 mm	1
10	517.0615	Ringmaulschlüssel, abgewinkelt, 15 mm	1
11	517.0616	Ringmaulschlüssel, abgewinkelt, 16 mm	1
12	517.0617	Ringmaulschlüssel, abgewinkelt, 17 mm	1
13	517.0618	Ringmaulschlüssel, abgewinkelt, 18 mm	1
14	517.0619	Ringmaulschlüssel, abgewinkelt, 19 mm	1
15	517.0620	Ringmaulschlüssel, abgewinkelt, 20 mm	1
16	517.0621	Ringmaulschlüssel, abgewinkelt, 21 mm	1
17	517.0622	Ringmaulschlüssel, abgewinkelt, 22 mm	1
18	517.0623	Ringmaulschlüssel, abgewinkelt, 23 mm	1
19	517.0624	Ringmaulschlüssel, abgewinkelt, 24 mm	1
20	517.0627	Ringmaulschlüssel, abgewinkelt, 27 mm	1
21	517.0630	Ringmaulschlüssel, abgewinkelt, 30 mm	1
22	517.0632	Ringmaulschlüssel, abgewinkelt, 32 mm	1
23	517.0701	Doppel-Maulschlüssel, 6 x 7 mm	1
24	517.0702	Doppel-Maulschlüssel, 8 x 9 mm	1
25	517.0704	Doppel-Maulschlüssel, 10 x 11 mm	1
26	517.0707	Doppel-Maulschlüssel, 12 x 13 mm	1
27	517.0709	Doppel-Maulschlüssel, 14 x 15 mm	1
28	517.0710	Doppel-Maulschlüssel, 16 x 17 mm	1
29	517.0712	Doppel-Maulschlüssel, 18 x 19 mm	1
30	517.0714	Doppel-Maulschlüssel, 20 x 22 mm	1
31	517.0716	Doppel-Maulschlüssel, 24 x 27 mm	1
32	517.0718	Doppel-Maulschlüssel, 30 x 32 mm	1
33	517.0801	Doppel-Ringschlüssel, gekröpft, 6 x 7 mm	1
34	517.0802	Doppel-Ringschlüssel, gekröpft, 8 x 9 mm	1
35	517.0804	Doppel-Ringschlüssel, gekröpft, 10 x 11 mm	1
36	517.0807	Doppel-Ringschlüssel, gekröpft, 12 x 13 mm	1
37	517.0809	Doppel-Ringschlüssel, gekröpft, 14 x 15 mm	1
38	517.0810	Doppel-Ringschlüssel, gekröpft, 16 x 17 mm	1
39	517.0812	Doppel-Ringschlüssel, gekröpft, 18 x 19 mm	1
40	517.0813	Doppel-Ringschlüssel, gekröpft, 20 x 22 mm	1

M T-Griff- und Schraubendreher-Satz

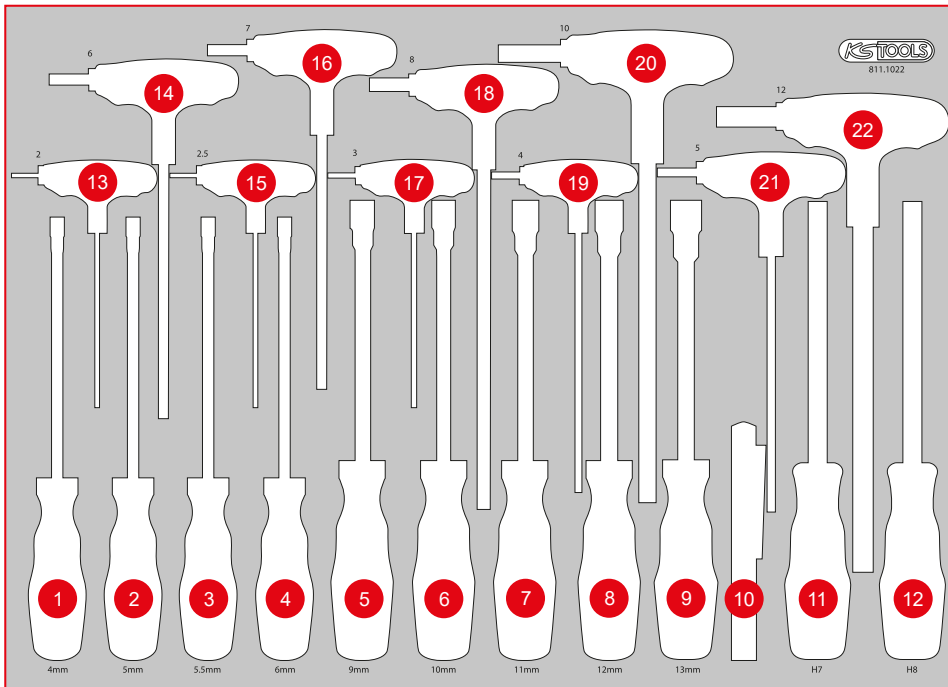

Pos.	Code	Bezeichnung	Teiligkeit
1	159.1201	ERGOTORQUEplus Stecknuss-Schraubendreher, 4 mm	1
2	159.1202	ERGOTORQUEplus Stecknuss-Schraubendreher, 5 mm	1
3	159.1203	ERGOTORQUEplus Stecknuss-Schraubendreher, 5,5 mm	1
4	159.1204	ERGOTORQUEplus Stecknuss-Schraubendreher, 6 mm	1
5	159.1207	ERGOTORQUEplus Stecknuss-Schraubendreher, 9 mm	1
6	159.1208	ERGOTORQUEplus Stecknuss-Schraubendreher, 10 mm	1
7	159.1209	ERGOTORQUEplus Stecknuss-Schraubendreher, 11 mm	1
8	159.1210	ERGOTORQUEplus Stecknuss-Schraubendreher, 12 mm	1
9	159.1211	ERGOTORQUEplus Stecknuss-Schraubendreher, 13 mm	1
10	150.4370	perfectLight Taschenlampe 85 Lumen	1
11	159.1127	ERGOTORQUEplus Stecknuss-Schraubendreher, 7 mm	1
12	159.2128	ERGOTORQUEplus Stecknuss-Schraubendreher, 8 mm	1
13	151.8130	T-Griff-Innensechskant-Kugelkopf-Schlüssel, 2 mm	1
14	151.8135	T-Griff-Innensechskant-Kugelkopf-Schlüssel, 6 mm	1
15	151.8131	T-Griff-Innensechskant-Kugelkopf-Schlüssel, 2,5 mm	1
16	151.8136	T-Griff-Innensechskant-Kugelkopf-Schlüssel, 7 mm	1
17	151.8132	T-Griff-Innensechskant-Kugelkopf-Schlüssel, 3 mm	1
18	151.8137	T-Griff-Innensechskant-Kugelkopf-Schlüssel, 8 mm	1
19	151.8133	T-Griff-Innensechskant-Kugelkopf-Schlüssel, 4 mm	1
20	151.8138	T-Griff-Innensechskant-Kugelkopf-Schlüssel, 10 mm	1
21	151.8134	T-Griff-Innensechskant-Kugelkopf-Schlüssel, 5 mm	1
22	151.8139	T-Griff-Innensechskant-Kugelkopf-Schlüssel, 12 mm	1

811.0017

M Zangen- / Hammer- / und Meißel-Satz



Pos.	Code	Bezeichnung	Teiligkeit
1	157.0205	Rund-Feile, Form F, 200 mm, Hieb 2	1
2	157.0005	Flachfeile, Form B, 200 mm, Hieb 2	1
3	157.0405	Dreikant-Feile, Form C, 200 mm, Hieb 2	1
4	157.0105	Halbrund-Feile, Form E, 200 mm, Hieb 2	1
5	156.0241	Flachmeißel mit Handschutzgriff, 8-kant, 20 mm	1
6	156.0254	Flachmeißel mit Handschutzgriff, 8-kant, 18 mm	1
7	201.2335	Bremssattel-Drahtbürste 2-reihig, gerade, 225 mm	1
8	115.1012	ERGOTORQUE Diagonal-Seitenschneider, 160 mm	1
9	115.1021	ERGOTORQUE Kombinationszange, 180 mm	1
10	300.0114	Bandmaß mit Feststeller, schwarz-rot, 5m, 19 mm	1
11	142.1402	Schlosser Hammer mit Fiberglasstiel, 400g	1
12	115.1019	ERGOTORQUE Flachrundzange, gebogen, 210 mm	1
13	115.1024	ERGOTORQUE Telefonzange, 200 mm	1
14	115.2010	Wasserpumpenzange mit Druckknopfverstellung, 240 mm	1
15	115.1033	Gripzange, 60 mm, 220 mm	1
16	142.5101	Fäustel mit Fiberglasstiel, 1000g	1
17	550.1001	2 in 1 Teleskop-Magnethalter mit Waschdüsen-Reinigungs- und Einstellwerkzeug, 150-675 mm	1

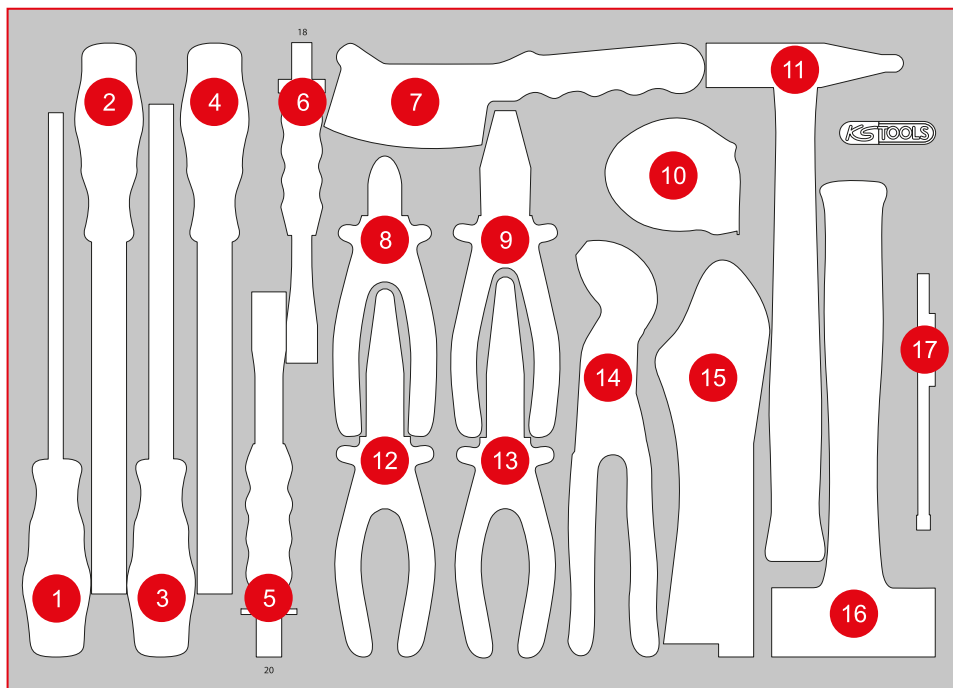

P10

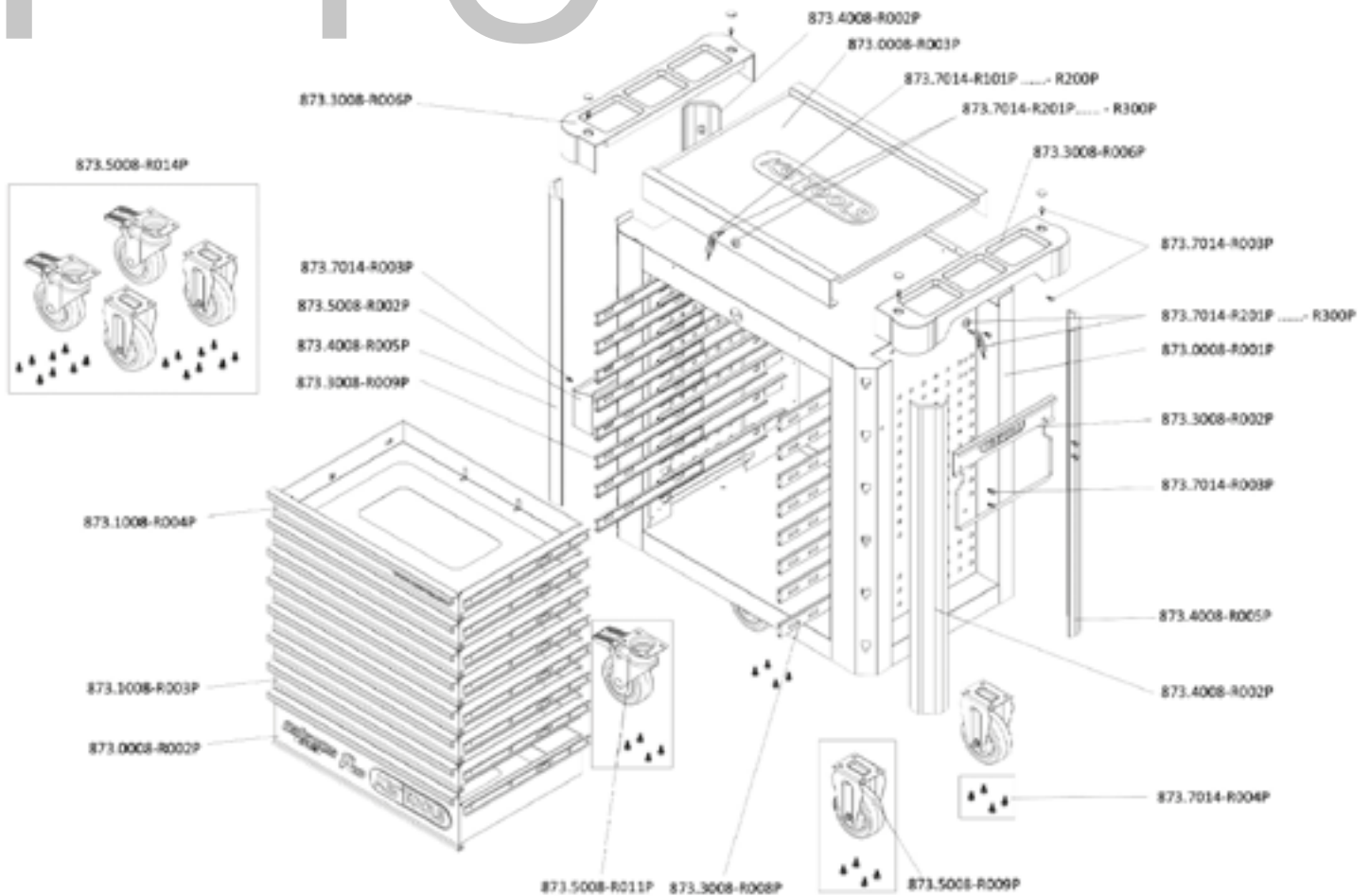

EINZELTEIL-LISTE

Art.-Nr.	Beschreibung	Menge
873.7014-R101P...	Ersatzschlüssel für Schloß Nummer xyz zu PERFORMANCEplus Werkstattwagen	2
873.7014-R201P...	Schloß mit 2 Schlüsseln zu PERFORMANCEplus Werkstattwagen Schloß-Nr. xyz	2
873.0008-R001P	Korpus mit Handgriff zu Werkstattwagen P10	1
873.0008-R002P	Schublade mit Logo und Kugelführung zu Werkstattwagen P10, 568x398x145 mm	1
873.0008-R003P	Edelstahl Arbeitsplatte zu Werkstattwagen P10	1
873.1008-R003P	Schublade mit Kugelführung zu Werkstattwagen P10/P10TC/P15, 568x398x65 mm	6
873.1008-R004P	Schublade mit Website und Kugelführung zu Werkstattwagen P10/P15, 568x398x65 mm	1
873.3008-R002P	Papierrollen-Halter zu PERFORMANCEplus Werkstattwagen P10/P15/P25	1
873.3008-R006P	Ablage für Arbeitsplatte zu Werkstattwagen	2
873.3008-R008P	Vollauszug Kugelführung mit autom. Rückzug	8
873.3008-R009P	Vollauszug Kugelführung mit autom. Rückzug	8
873.4008-R002P	Kunststoff-Stoßfänger für vorne rechts und hinten links	2
873.4008-R005P	Kunststoff-Stoßfänger für vorne links und hinten rechts	2
873.5008-R002P	Dosen-Halter zu PERFORMANCEplus Werkstattwagen P10/P15/P25/P35	1
873.5008-R009P	Laufrolle starr für PERFORMANCEplus Werkstattwagen inkl. Schrauben	2
873.5008-R011P	Lenkrolle mit Bremse zu PERFORMANCEplus Werkstattwagen inkl. Schrauben	2
873.5008-R014P	Rollen-Satz zu PERFORMANCEplus Werkstattwagen inkl. Schrauben	1
873.7014-R003P	Schraube M6x12 für PERFORMANCEplus Werkstattwagen-Zubehör	14
873.7014-R004P	Schraube M8 für Rollen zu PERFORMANCEplus Werkstattwagen (16 Stück)	1



873.7014-R101P...R200P
Ersatzschlüssel für Schlossnum-
mer xyz



873.7014-R201P...R300P
Schloss inklusive 2 Schlüssel,
Schlossnummer xyz



873.3008-R008P
Laufschiene mit Selbsteinzug,
für Schublade, rechts



873.3008-R009P
Laufschiene mit Selbsteinzug,
für Schublade, links



873.5008-R009P
Laufrolle, starr, inklusive
Schrauben



873.5008-R011P
Lenkrolle mit Feststellbremse
inklusive Schrauben

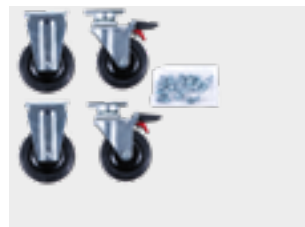

873.5008-R014P
Rollensatz, 2 x Lenkrolle + 2 x
Laufrolle, inklusive Schrauben



873.0008-R003P
Edelstahl-Arbeitsplatte



873.3008-R006P
Ablagefach inklusive Schrauben-
abdeckung, beidseitig verwendbar



873.1008-R004P
Schublade mit Website, inklusive
Laufschiene, H=65 mm, B=568
mm x T=398 mm



873.1008-R003P
Schublade, inklusive Laufschiene,
H=65 mm, B=568 mm x T=398 mm



873.0008-R002P
Schublade mit Logo, inkl. Lauf-
schiene, H=145 mm, B=568 mm
x T=398 mm



873.5008-R002P
Dosenhalter inklusive Schrauben,
B = 310 mm



873.3008-R002P
Papierrollenhalter inklusive
Schrauben, B = 320 mm



873.4008-R005P
Kunststoff-Stoßfänger für vorne links
und hinten rechts



873.4008-R002P
Kunststoff-Stoßfänger für vorne
rechts und hinten links



873.7014-R004P
Schraube, M8, mit Unterlegscheibe,
16 Stück



873.7014-R003P
Schraube, M6 x 12 mm, 1 Stück



873.0008-R001P
Stahlkorpus mit Griff



Tausend tolle Teile
für thought Typen!