

Metal Foil Current Sense Resistors, Low Value (Down to 0.001 Ω)

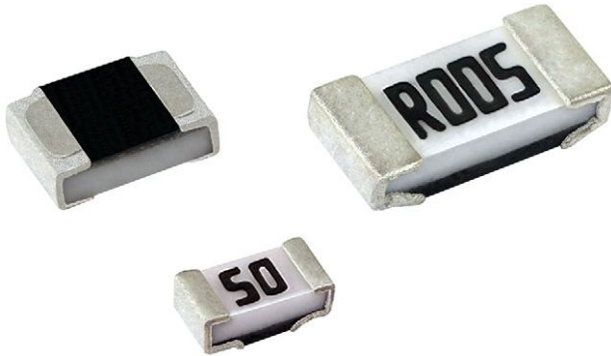

FEATURES

- Ultra low sensing resistance
- Low TCR (down to 50 ppm/°C)
- Chip size down to 0402, minimizing board space
- Sulfur resistant
- Material categorization: for definitions of compliance please see www.vishay.com/doc?99912



RoHS
COMPLIANT
HALOGEN
FREE

APPLICATIONS

- Switching power supply
- Voltage regulation module
- DC/DC converter, adaptor, battery pack, charger
- Pad and cell phone
- Power management

STANDARD ELECTRICAL SPECIFICATIONS					
GLOBAL MODEL	SIZE	POWER RATING W	TOLERANCE %	RESISTANCE VALUE RANGE Ω	WEIGHT (typical) g/1000 pieces
WFC0402	0402	0.125	± 1, ± 2, ± 5	0.003 to 0.05	1.1
WFC0603	0603	0.33	± 1, ± 2, ± 5	0.001 to 0.005	3.3
	0603	0.25	± 1, ± 2, ± 5	0.0051 to 0.03	3.3
WFC0805	0805	0.50	± 1, ± 2, ± 5	0.001 to 0.04	6.8
WFC1206	1206	1.0	± 1, ± 2, ± 5	0.001 to 0.05	17.4
	1206	0.5	± 1, ± 2, ± 5	0.100 to 0.18	17.4

GLOBAL PART NUMBER INFORMATION																
Global Part Numbering Example: WFC1206R0100FE66																
W	F	C	1	2	0	6	R	0	1	0	0	F	E	6	6	
GLOBAL MODEL (3 digits)			CASE SIZE (EIA) (4 digits)				RESISTANCE VALUE (5 digits) ⁽¹⁾					TOLERANCE CODE (1 digit)		PACKAGING CODE (3 digits)		
WFC			0402 0603 0805 1206				L = mΩ ⁽²⁾ R = decimal 5L000 = 0.005 Ω R0100 = 0.01 Ω					F = ± 1.0 % G = ± 2.0 % J = ± 5.0 %		E66 = lead (Pb)-free 7" tape/reel		

Notes

⁽¹⁾ Resistance values are available per E12 and E24 decades; www.vishay.com/doc?28372

⁽²⁾ Use "L" for resistance values < 0.01 Ω

TECHNICAL SPECIFICATIONS					
PARAMETER	UNIT	RESISTOR CHARACTERISTICS			
		WFC0402	WFC0603	WFC0805	WFC1206
Temperature coefficient	ppm/°C	± 100 for 8 mΩ to 50 mΩ	± 75 for 10 mΩ to 30 mΩ	± 50 for 10.1 mΩ to 40 mΩ	± 50 for 10.1 mΩ to 180 mΩ
		± 150 for 3 mΩ to 7 mΩ	± 150 for 5.1 mΩ to 9 mΩ	± 100 for 1 mΩ to 10 mΩ	± 100 for 1 mΩ to 10 mΩ
		-	± 100 for 1 mΩ to 5 mΩ	-	-
Operating temperature range	°C	-55 to +170			
Maximum working voltage	V	$(P \times R)^{1/2}$			
Maximum element temperature	°C	170			

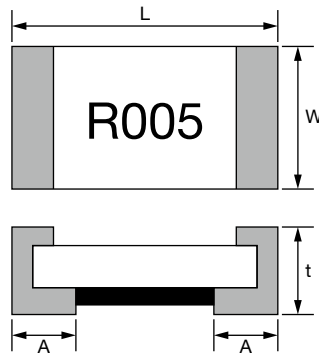
DIMENSIONS in inches (millimeters)

TYPE (INCH SIZE)	RESISTANCE RANGE (mΩ)	DIMENSIONS (in millimeters)			
		L	W	t	A
WFC0402	7.1 to 50	1.00 ± 0.10	0.55 ± 0.10	0.45 ± 0.10	0.25 ± 0.10
	3 to 7				0.35 ± 0.10
WFC0603	5 to 30	1.60 ± 0.10	0.80 ± 0.10	0.55 ± 0.15	0.30 ± 0.20
	1 to 5				0.55 ± 0.20
WFC0805	5 to 40	2.00 ± 0.20	1.30 ± 0.15	0.70 ± 0.15	0.45 ± 0.20
	1 to 5	2.10 ± 0.20	1.40 ± 0.20	0.60 max.	0.60 ± 0.20
WFC1206	1 to 3	3.10 ± 0.20	1.55 ± 0.20	0.75 ± 0.25	1.30 ± 0.20
	3 to 180			0.80 ± 0.15	0.55 ± 0.20

Note

- 0402 has no marking; 0603, 0805, 1206 marking shows two digits for resistance

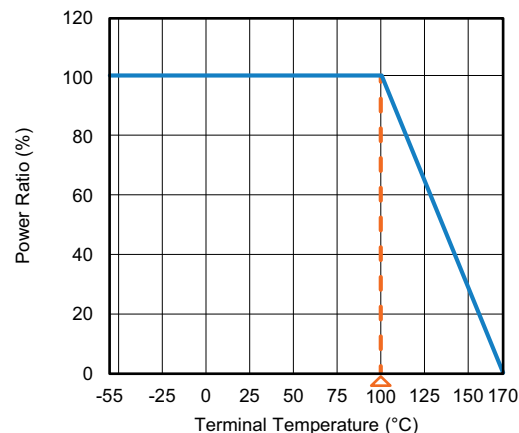
DERATING

PERFORMANCES

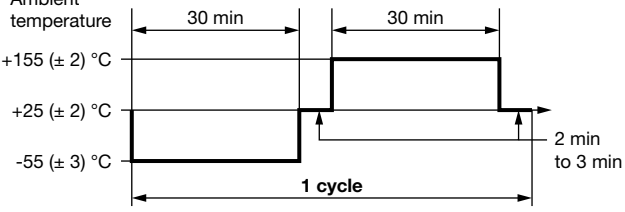
ENVIRONMENTAL PERFORMANCE			
NO.	ITEM	TEST CONDITION	SPECIFICATION
1	Short time overload	5 times rated power for 5 seconds (JIS-C5202-5.5)	$\Delta R: \pm (1 \% + 0.0005 \Omega)$
2	Temperature coefficient of resistance (TCR)	+25 °C / +125 °C (JIS-C5202-5.2) $TCR (ppm/^{\circ}C) = \frac{\Delta R}{R \times \Delta t} \times 10^6$	Refer to Electrical Specification
3	Damp heat with load	The specimens shall be placed in a chamber and subjected to a relative humidity of 90 % to 95 % and a temperature of 40 °C \pm 2 °C for the period of 1000 hours with applying rated power 1.5 hours ON and 0.5 hour OFF. (MIL-STD-202, method 103)	$\Delta R: \pm (1 \% + 0.0005 \Omega)$
4	High temperature exposure	The chip (mounted on board) is exposed in the heat chamber 125 °C \pm 3 °C for 1000 hours. (JIS-C5202-7.2)	$\Delta R: \pm (1 \% + 0.0005 \Omega)$
5	Load life	Apply rated power at 70 °C \pm 2 °C for 1000 hours with 1.5 hours ON and 0.5 hour OFF. (JIS-C5202-7.10)	$\Delta R: \pm (1 \% + 0.0005 \Omega)$
6	Rapid change of temperature	The chip (mounted on board) is exposed, -55 °C \pm 3 °C (30 min.) / +155 °C \pm 2 °C (30 min.) for 5 cycles. The following conditions as the following figure. (JIS-C5202-7.4) 	$\Delta R: \pm (1 \% + 0.0005 \Omega)$

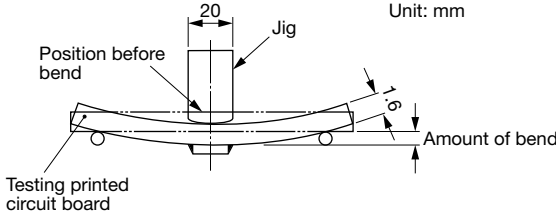
FUNCTION PERFORMANCE			
NO.	ITEM	TEST CONDITION	SPECIFICATION
1	Bending strength	Mount the chip to test substrate. Apply pressure in direction of arrow unit band width reaches 2 mm (+0.2 / -0 mm) illustrated in the figure below and hold for 10 s \pm 1 s. (JIS-C5202-6.1) 	$\Delta R: \pm (1 \% + 0.0005 \Omega)$
2	Solvent resistance	Complete immersion of specimens in isopropyl alcohol for 3 (+5, -0) min. 25 °C \pm 5 °C. (MIL-STD-202, method 215)	Verify marking permanency. (not required for laser etched parts or parts with no marking)
3	Resistance to solder heat	The specimen chip shall be immersed into the flux specified in the solder bath 260 °C \pm 5 °C for 10 s \pm 1 s. (MIL-STD-202, method 210)	$\Delta R: \pm (1 \% + 0.0005 \Omega)$

FUNCTION PERFORMANCE			
NO.	ITEM	TEST CONDITION	SPECIFICATION
4	Solderability	<p>The specimen chip shall be immersed into the flux specified in the solder bath $235\text{ }^{\circ}\text{C} \pm 5\text{ }^{\circ}\text{C}$ for $2\text{ s} \pm 0.5\text{ s}$. It shall be immersed to a point 10 mm from its root. (Sn96.5 / Ag3.0 / Cu0.5) (JIS-C5 202-6.11)</p> <p>h = 10 mm H = 10 mm min.</p>	Solder shall be covered 95 % or more of the electrode area.

Notes

- 0.5 W with total solder pad trace size of 100 mm^2 . The surface temperature of component should below $100\text{ }^{\circ}\text{C}$
- 1.0 W with total solder pad trace size of 100 mm^2 . The surface temperature of component should below $100\text{ }^{\circ}\text{C}$

TAPE PACKAGING SPECIFICATIONS			
MODEL	REEL		
	TAPE WIDTH	DIAMETER	PIECES/REEL
WFC0402	Embossed paper tape	178 mm / 7"	10 000
WFC0603, WFC0805, WFC1206	Embossed paper tape	178 mm / 7"	5000

Note

- Embossed carrier tape per EIA (EIAJ)

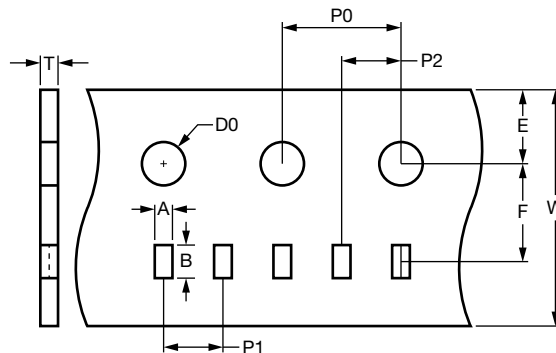
PAPER TAPE SPECIFICATIONS

TYPE	RESISTANCE RANGE	CARRIER DIMENSIONS (in millimeters)									
		A	B	E	F	W	P0	P1	P2	D0	T
WFC0402	3 m Ω to 50 m Ω	0.7 ± 0.05	1.2 ± 0.05	1.75 ± 0.1	3.5 ± 0.05	8.0 ± 0.2	4.0 ± 0.1	2.0 ± 0.1	2.0 ± 0.05	1.55 ± 0.05	0.6 ± 0.1
WFC0603	1 m Ω to 5 m Ω	1.4 ± 0.1	1.9 ± 0.1	1.75 ± 0.1	3.5 ± 0.05	8.0 ± 0.2	4.0 ± 0.1	4.0 ± 0.1	2.0 ± 0.05	1.55 ± 0.05	0.75 ± 0.1
WFC0603	5.1 m Ω to 30 m Ω	1.1 ± 0.1	1.9 ± 0.1	1.75 ± 0.1	3.5 ± 0.05	8.0 ± 0.2	4.0 ± 0.1	4.0 ± 0.1	2.0 ± 0.05	1.55 ± 0.05	0.70 ± 0.1
WFC0805	1 m Ω to 5 m Ω	2.4 ± 0.1	1.9 ± 0.1	1.75 ± 0.1	3.5 ± 0.05	8.0 ± 0.2	4.0 ± 0.1	4.0 ± 0.1	2.0 ± 0.05	1.55 ± 0.05	0.75 ± 0.1
WFC0805	5.1 m Ω to 40 m Ω	1.6 ± 0.1	2.4 ± 0.1	1.75 ± 0.1	3.5 ± 0.05	8.0 ± 0.2	4.0 ± 0.1	4.0 ± 0.1	2.0 ± 0.05	1.55 ± 0.05	0.97 ± 0.1
WFC1206	1 m Ω to 3 m Ω	2.0 ± 0.1	3.6 ± 0.1	1.75 ± 0.1	3.5 ± 0.05	8.0 ± 0.2	4.0 ± 0.1	4.0 ± 0.1	2.0 ± 0.05	1.55 ± 0.05	0.87 ± 0.1
WFC1206	3.1 m Ω to 180 m Ω	2.0 ± 0.1	3.6 ± 0.1	1.75 ± 0.1	3.5 ± 0.05	8.0 ± 0.2	4.0 ± 0.1	4.0 ± 0.1	2.0 ± 0.05	1.55 ± 0.05	0.97 ± 0.1

Notes

- Embossed carrier tape per EIA (EIAJ)
- Additional packaging details at www.vishay.com/doc?20051

STORAGE CONDITIONS

Temperature: 5 °C to 35 °C, humidity: 40 % to 75 %

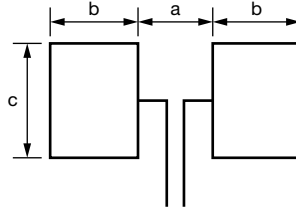
RECOMMENDED SOLDER PAD LAYOUT

TYPE	PAD LAYOUT DIMENSIONS (in millimeters)		
	a	b	c
0402 (7.1 mΩ to 50 mΩ)	0.50	0.50	0.60
0402 (3 mΩ to 7 mΩ)	0.30	0.60	0.60
0603 (9.1 mΩ to 30 mΩ)	0.90	0.70	1.00
0603 (5 mΩ to 9 mΩ)	0.60	0.90	1.00
0805 (1 mΩ to 5 mΩ)	0.80	1.60	1.45
0805 (5.1 mΩ to 40 mΩ)	1.20	1.20	1.40
1206 (1 mΩ to 3 mΩ)	0.40	1.80	2.20
1206 (3.1 mΩ to 180 mΩ)	2.20	1.30	1.80

Note

- Recommend to use the steel plate which thickness > 100 μm to avoid the insufficient solder height

SOLDERING RECOMMENDATIONS

- Peak reflow temperatures and durations:
 - IR reflow peak = 260 °C max. for 10 s
 - Wave solder = 260 °C max. for 10 s
- Compatible with lead and lead (Pb)-free solder reflow processes
- Recommended IR reflow profile for surface mount devices: www.vishay.com/doc?31052



Disclaimer

ALL PRODUCT, PRODUCT SPECIFICATIONS AND DATA ARE SUBJECT TO CHANGE WITHOUT NOTICE TO IMPROVE RELIABILITY, FUNCTION OR DESIGN OR OTHERWISE.

Vishay Intertechnology, Inc., its affiliates, agents, and employees, and all persons acting on its or their behalf (collectively, "Vishay"), disclaim any and all liability for any errors, inaccuracies or incompleteness contained in any datasheet or in any other disclosure relating to any product.

Vishay makes no warranty, representation or guarantee regarding the suitability of the products for any particular purpose or the continuing production of any product. To the maximum extent permitted by applicable law, Vishay disclaims (i) any and all liability arising out of the application or use of any product, (ii) any and all liability, including without limitation special, consequential or incidental damages, and (iii) any and all implied warranties, including warranties of fitness for particular purpose, non-infringement and merchantability.

Statements regarding the suitability of products for certain types of applications are based on Vishay's knowledge of typical requirements that are often placed on Vishay products in generic applications. Such statements are not binding statements about the suitability of products for a particular application. It is the customer's responsibility to validate that a particular product with the properties described in the product specification is suitable for use in a particular application. Parameters provided in datasheets and / or specifications may vary in different applications and performance may vary over time. All operating parameters, including typical parameters, must be validated for each customer application by the customer's technical experts. Product specifications do not expand or otherwise modify Vishay's terms and conditions of purchase, including but not limited to the warranty expressed therein.

Hyperlinks included in this datasheet may direct users to third-party websites. These links are provided as a convenience and for informational purposes only. Inclusion of these hyperlinks does not constitute an endorsement or an approval by Vishay of any of the products, services or opinions of the corporation, organization or individual associated with the third-party website. Vishay disclaims any and all liability and bears no responsibility for the accuracy, legality or content of the third-party website or for that of subsequent links.

Except as expressly indicated in writing, Vishay products are not designed for use in medical, life-saving, or life-sustaining applications or for any other application in which the failure of the Vishay product could result in personal injury or death. Customers using or selling Vishay products not expressly indicated for use in such applications do so at their own risk. Please contact authorized Vishay personnel to obtain written terms and conditions regarding products designed for such applications.

No license, express or implied, by estoppel or otherwise, to any intellectual property rights is granted by this document or by any conduct of Vishay. Product names and markings noted herein may be trademarks of their respective owners.