



**Part no.: 50137473**  
**OGS 600-140/CN-M12**  
**Optical guidance sensor**



Figure can vary



CANopen

RS232



## Contents

- Technical data
- Dimensioned drawings
- Electrical connection
- Diagrams
- Notes
- Accessories

## Technical data

<b>Basic data</b>	
Series	OGS 600
Application	Optical guidance
Trace types	Dark trace on light background Light trace on dark background Retro-reflective trace
<b>Optical data</b>	
Working range	10 ... 70 mm
Light source	LED , Red
LED light wavelength	634 nm
Transmitted-signal shape	Pulsed
Detection width for complete trace	115 mm
<b>Measurement data</b>	
Measurement value resolution	1 mm , Working distance 35 mm
Linearity error	0 ... 5 mm , Working distance 35 mm
Output value for edges	170 ... 1,330
Maximum output value	0 ... 1,500
<b>Electrical data</b>	
Protective circuit	Polarity reversal protection Short circuit protected
<b>Performance data</b>	
Supply voltage $U_B$	18 ... 30 V , DC
Average power consumption	4 W
<b>Outputs</b>	
Number of digital switching outputs	1 Piece(s)
<b>Switching outputs</b>	
Type	Digital switching output
Voltage type	DC
Switching current, max.	100 mA
Switching voltage	High: $\geq(U_B-2V)$ Low: $\leq 2V$
<b>Switching output 1</b>	
Switching element	Transistor , PNP
Switching principle	Trace monitoring / contrast monitoring, adjustable
<b>Timing</b>	
Cycle time	10 ms
<b>Interface</b>	
Type	CANopen
<b>CANopen</b>	
Function	Process
Transmission speed	10 ... 1,000 kBit/s
<b>Service interface</b>	
Type	RS 232

**Part no.: 50137473 – OGS 600-140/CN-M12 – Optical guidance sensor**

Transmission speed	115,200 bit/s
--------------------	---------------

**Connection**

Number of connections	2 Piece(s)
-----------------------	------------

**Connection 1**

Type of connection	Connector
Function	Data interface
Thread size	M12
Type	Female
Material	Metal
No. of pins	5 -pin
Encoding	A-coded

**Connection 2**

Type of connection	Connector
Function	Service interface Signal OUT Voltage supply
Thread size	M12
Type	Male
Material	Metal
No. of pins	5 -pin
Encoding	A-coded

**Mechanical data**

Design	Cubic
Dimension (W x H x L)	34.5 mm x 47.5 mm x 216 mm
Housing material	Aluminum
Lens cover material	Plastic
Net weight	245 g
Housing color	Red
Type of fastening	Supplied mounting bracket

**Operation and display**

Type of configuration	Software
-----------------------	----------

**Environmental data**

Ambient temperature, operation	-15 ... 50 °C
Ambient temperature, storage	-30 ... 60 °C

**Certifications**

Degree of protection	IP 65
Protection class	III
Certifications	c UL US
Standards applied	EN 60947-5-2:2007+A1:2012

**Classification**

Customs tariff number	85365019
eCl@ss 8.0	27270906
eCl@ss 9.0	27270906
ETIM 5.0	EC001820

## Dimensioned drawings

All dimensions in millimeters

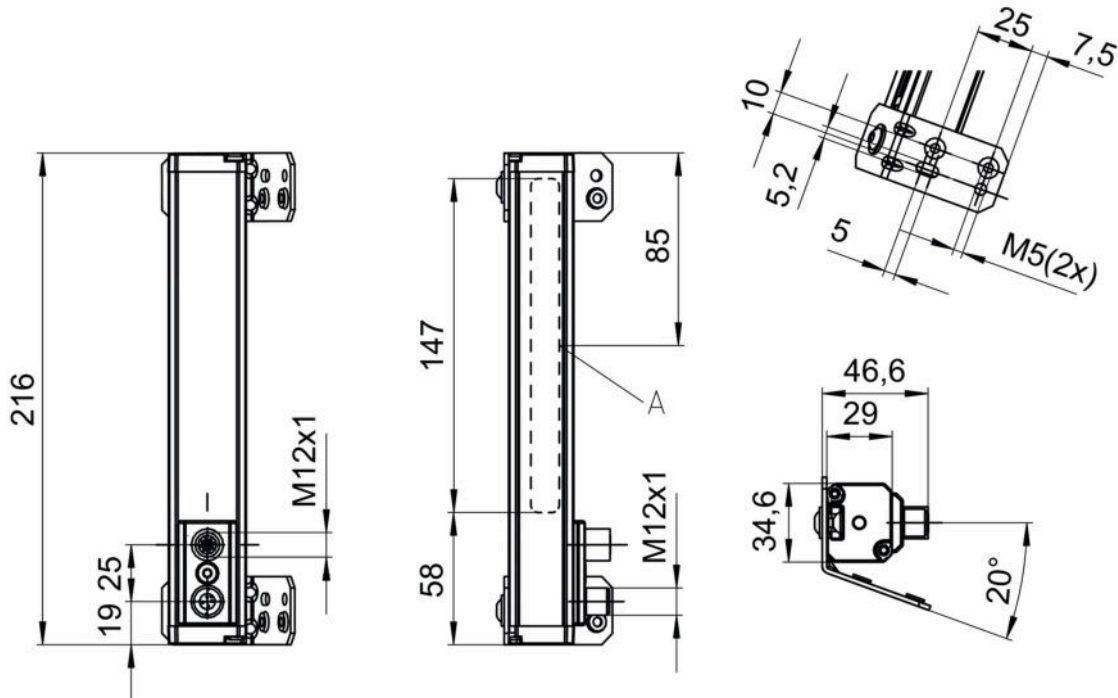

A Integrated illumination

## Electrical connection

Connection 1	
Type of connection	Connector
Function	Data interface
Thread size	M12
Type	Female
Material	Metal
No. of pins	5 -pin
Encoding	A-coded

Pin	Pin assignment
1	CAN Shield
2	n.c.
3	CAN GND
4	CAN H
5	CAN L

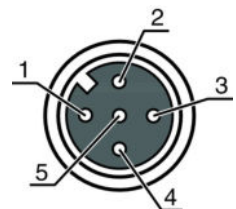

Connection 2	
Type of connection	Connector
Function	Service interface Signal OUT Voltage supply

Part no.: 50137473 – OGS 600-140/CN-M12 – Optical guidance sensor

Connection 2	
Thread size	M12
Type	Male
Material	Metal
No. of pins	5 -pin
Encoding	A-coded

Pin	Pin assignment
1	V+
2	RxD RS232
3	GND
4	OUT 1
5	TxD RS 232

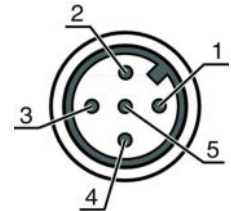

**Diagrams**

Typical value of characteristic curve: linearity error

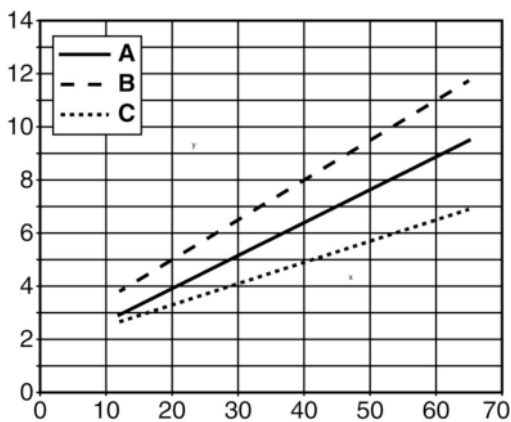

x Floor-sensor distance [mm]  
 y Linearity error [mm]  
 A Typical value  
 B max.  
 C min.

Sensor characteristic curve with one trace

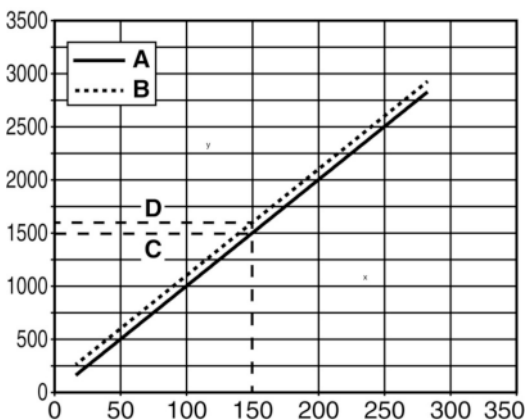

## Part no.: 50137473 – OGS 600-140/CN-M12 – Optical guidance sensor

x	Position of the trace's left edge below the sensor [mm]
y	Edge position
A	Measurement value of left edge
B	Measurement value of right edge
C	Position of left edge
D	Position of right edge

### Notes

#### Observe intended use!



- This product is not a safety sensor and is not intended as personnel protection.
- The product may only be put into operation by competent persons.
- Only use the product in accordance with its intended use.

#### For UL applications:

- For UL applications, use is only permitted in Class 2 circuits in accordance with the NEC (National Electric Code).
- Max. ambient temperature: 50°C
- "Only for use in NFPA 79 applications"
- "Only suitable for indoors"

### Accessories

#### Connection technology - Connection cables

	Part no.	Designation	Article	Description
	50114692	KB DN/CAN-2000 BA	Connection cable	Suitable for interface: DeviceNet, CANopen Connection 1: Connector, M12, Axial, Female, A-coded, 5 -pin Connection 2: Open end Shielded: Yes Cable length: 2,000 mm Sheathing material: PUR
	50114693	KB DN/CAN-2000 SA	Connection cable	Suitable for interface: DeviceNet, CANopen Connection 1: Connector, M12, Axial, Male, A-coded, 5 -pin Connection 2: Open end Shielded: Yes Cable length: 2,000 mm Sheathing material: PUR

#### Note

A list with all available accessories can be found on the Leuze electronic website in the Download tab of the article detailed page.