



CE

Model Number

OMH-VDM18-01

Mounting accessory, distance measuring devices Series VDM18

Dimensions

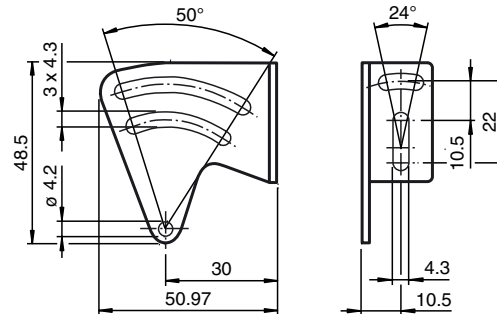

Technical data

Mechanical specifications

Material	Stainless steel
Mass	approx. 24 g
Mounting	Mounting accessories included

Suitable series

Series	VDM18
--------	-------