

**Photoelectric sensor
Laser Distance Sensor (Triangulation)
Q4XTILAF100-Q8**

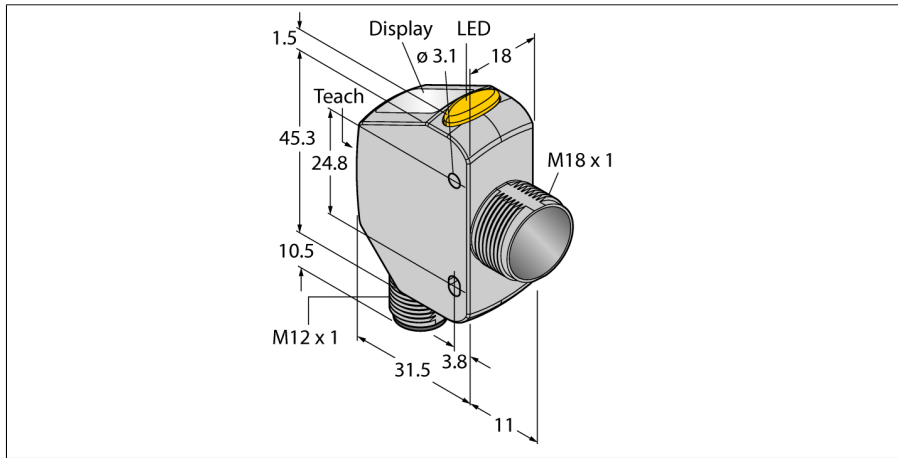

- 4-digit 7-segment LED display
- 3 buttons
- Output indicator (yellow)
- IP67/69K
- ECOLAB-certified
- Range: 25...100 mm
- Laser class 1, red, 655 nm, acc. to IEC 60825-1:2007
- Operating voltage: 12...30 VDC
- Analog output: 4 ... 20 mA
- Rectangular model with offset M18 thread
- Stainless steel case (1.4404)

Type designation	Q4XTILAF100-Q8
Ident no.	3094885
Operating mode	Laser sensor, diffuse mode (triangulation)
Light type	red
Wavelength	655 nm
Laser class	▲ 1
Optical resolution	0.15 mm
Repeatability	0.075 mm
Range	25...100 mm
Ambient temperature	-10...+50 °C
Relative humidity min.	35 %
Relative humidity max.	95 %
Storage temperature	-25...+75 °C
Ambient light immunity	> 5000 lux
Operating voltage	10...30 VDC
DC rated operational current	≤ 28 mA
Short-circuit protection	yes
Reverse polarity protection	yes
Type of analog output	4...20 mA
Current output	4...20mA
Load resistance	≤ 1000 Ω
Readiness delay	≤ 750 ms
Response time typical	< 0.5 ms
Approvals	CE, cULus, ECOLAB
Design	Rectangular, Q4X
Dimensions	43.5 mm x 18 mm x 57.5 mm
Housing material	Stainless steel, V4A (1.4404)
Lens	acrylic, PMMA
Electrical connection	Connector, M12 1
Protection class	IP67/IP69K
Vibration resistance	MIL-STD-202G, Method 201A (10 to 60 Hz, 1.52 mm peak to peak amplitude, for 2 hours along the x, y and z-axis), sensor operating
Shock test	MIL-STD-202G, Method 213B Condition I (100G 6x along the XYZ-axis, 18 impacts), sensor in operation
Switching state	LED yellow
Display	4-digit 7-segment LED display

Wiring Diagram

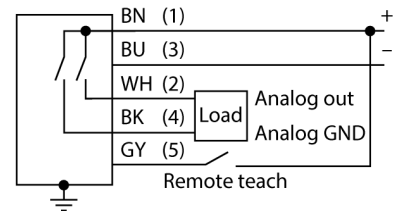

Functional principle

The Q4X is a laser-distance sensor working on the principle of laser triangulation. It has a range of 25...100 mm, a resolution of 0.15 mm and an analog laser class 1 power output (4...20 mA).

With the dual mode functionality, the Q4X captures not only distances but also the light intensity that is reflected by an object. This unique feature allows lasers to be used for applications that would have been inconceivable before this.

In RUN mode, you can change the switch-point, adjust light and dark-switching and teach the sensor accordingly. In SETUP mode, you can select teach, all standard operating parameters and also return to the factory defaults.

Excess Gain Curve

Photoelectric sensor
Laser Distance Sensor (Triangulation)
Q4XTILAF100-Q8

TURCK

Industrial
Automation

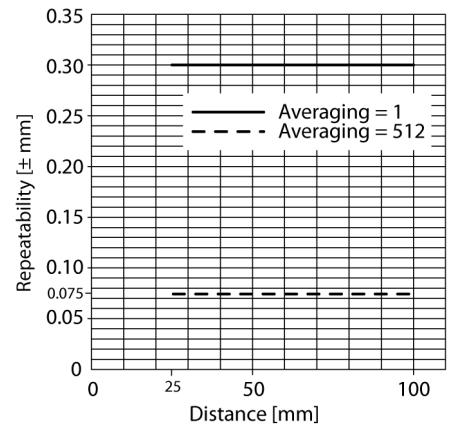

**Photoelectric sensor
Laser Distance Sensor (Triangulation)
Q4XTILAF100-Q8**

Accessories

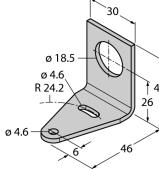
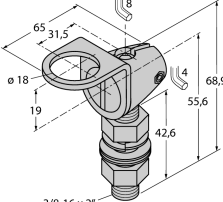
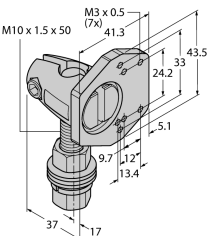
Type code	Ident no.	Description	
SMB18A	3033200	Mounting bracket, rectangular, stainless steel, for sensors with 18 mm thread	
SMB18FAM10	3011184	Mounting bracket, material VA 1.4401, for M10 x 1.5 thread, thread length 18 mm	
SMBQ4XFAM10	3091513	Mounting bracket, rotatable, stainless steel, for sensors of the Q4X/Q3X series, M10 x 1.5 thread	

Wiring accessories

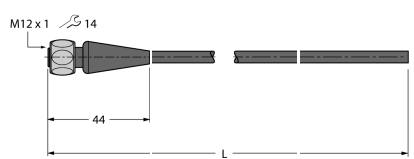
Type code	Ident no.	Description	
RKC4.5T-2/TEL	6625016	Connection cable, female M12, straight, 5-pin, cable length: 2 m, sheath material: PVC, black; cULus approval; other cable lengths and qualities available, see www.turck.com	
RKH4.5-2/TFG	6933455	Connection cable, M12 female connector, angled, 5-pin, cable length: 2 m, sheath material: TPE, gray; Ecolab approved, FDA and RoHS compliant; IP67, IP69K; Other cable lengths and designs are available, see www.turck.com	

**Photoelectric sensor
Laser Distance Sensor (Triangulation)
Q4XTILAF100-Q8**

Wiring accessories

Type code	Ident no.	Description	
RKS4.5T-2/TEL	6626361	Connection cable, M12 female connector, straight, 5-pin, cable length: 2 m, sheath material: PVC, black; shielded; cULus approval; other cable lengths and qualities available, see www.turck.com	
WKS4.5T-2/TEL	6626364	Connection cable, M12 female connector, angled, 5-pin, cable length: 2 m, sheath material: PVC, black; shielded; cULus approval; other cable lengths and qualities available, see www.turck.com	

Function accessories

Type code	Ident no.	Description	
BRT-Q4X-60X18	3095776	Reflector for Q4X laser sensors for clear object detection or dual-mode applications, rectangular housing: 60 mm x 18 mm	
BRT-Q4X-60X50	3095777	Reflector for Q4X laser sensors, for clear object detection or dual-mode applications, rectangular housing: 60 mm x 50 mm	