



PBHV8140Z

500 V, 1 A NPN high-voltage low V_{CEsat} (BISS) transistor

Rev. 01 — 11 December 2009

Product data sheet

1. Product profile

1.1 General description

NPN high-voltage low V_{CEsat} Breakthrough In Small Signal (BISS) transistor in a medium power SOT223 (SC-73) Surface-Mounted Device (SMD) plastic package.

PNP complement: PBHV9540Z.

1.2 Features

- High voltage
- Low collector-emitter saturation voltage V_{CEsat}
- High collector current capability I_C and I_{CM}
- High collector current gain (h_{FE}) at high I_C
- AEC-Q101 qualified
- Medium power SMD plastic package

1.3 Applications

- LED driver for LED chain module
- LCD backlighting
- Automotive motor management
- Switch Mode Power Supply (SMPS)

1.4 Quick reference data

Table 1. Quick reference data

Symbol	Parameter	Conditions	Min	Typ	Max	Unit
V_{CESM}	collector-emitter peak voltage	$V_{BE} = 0\text{ V}$	-	-	500	V
V_{CEO}	collector-emitter voltage	open base	-	-	400	V
I_C	collector current		-	-	1	A
h_{FE}	DC current gain	$V_{CE} = 10\text{ V};$ $I_C = 50\text{ mA}$	[1] 100	155	-	

[1] Pulse test: $t_p \leq 300\text{ }\mu\text{s}; \delta \leq 0.02$.

2. Pinning information

Table 2. Pinning

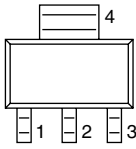
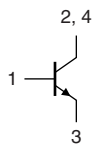
Pin	Description	Simplified outline	Graphic symbol
1	base		
2	collector		
3	emitter		
4	collector		

sym016

3. Ordering information

Table 3. Ordering information

Type number	Package		
	Name	Description	Version
PBHV8140Z	SC-73	plastic surface-mounted package with increased heatsink; 4 leads	SOT223

4. Marking

Table 4. Marking codes

Type number	Marking code
PBHV8140Z	V8140Z

5. Limiting values

Table 5. Limiting values

In accordance with the Absolute Maximum Rating System (IEC 60134).

Symbol	Parameter	Conditions	Min	Max	Unit	
V_{CBO}	collector-base voltage	open emitter	-	500	V	
V_{CEO}	collector-emitter voltage	open base	-	400	V	
V_{CESM}	collector-emitter peak voltage	$V_{BE} = 0$ V	-	500	V	
V_{EBO}	emitter-base voltage	open collector	-	6	V	
I_C	collector current		-	1	A	
I_{CM}	peak collector current	single pulse; $t_p \leq 1$ ms	-	2	A	
I_{BM}	peak base current	single pulse; $t_p \leq 1$ ms	-	400	mA	
P_{tot}	total power dissipation	$T_{amb} \leq 25$ °C	[1]	-	0.73	W
			[2]	-	1.45	W
T_j	junction temperature		-	150	°C	
T_{amb}	ambient temperature		-55	+150	°C	
T_{stg}	storage temperature		-65	+150	°C	

[1] Device mounted on an FR4 Printed-Circuit Board (PCB), single-sided copper, tin-plated and standard footprint.

[2] Device mounted on an FR4 PCB, single-sided copper, tin-plated and mounting pad for collector 6 cm².

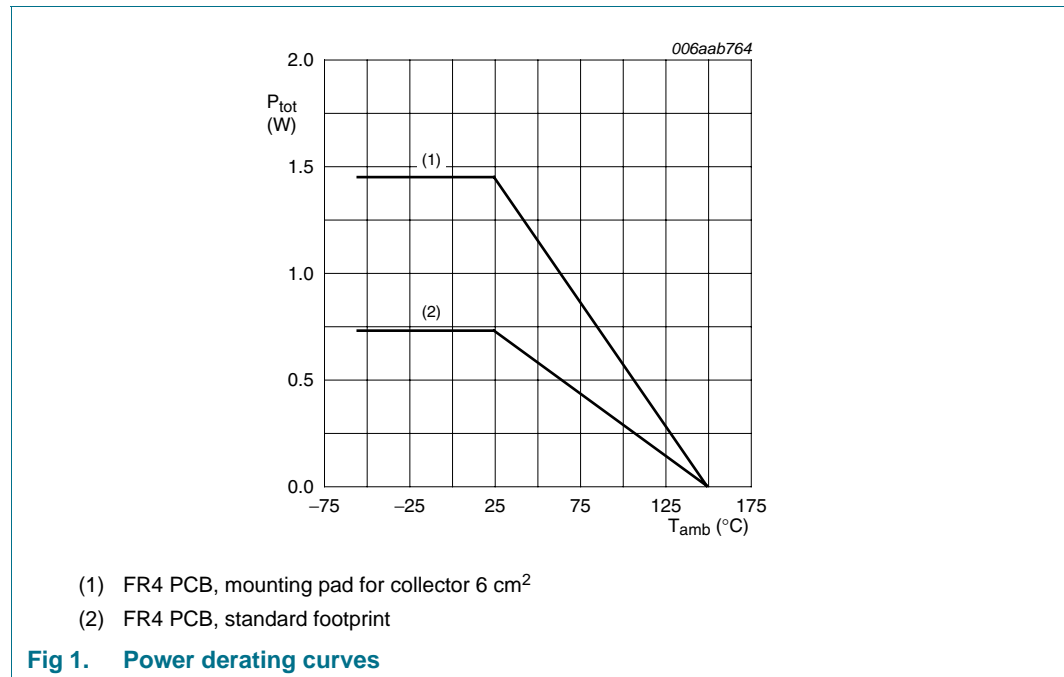

6. Thermal characteristics

Table 6. Thermal characteristics

Symbol	Parameter	Conditions	Min	Typ	Max	Unit	
$R_{th(j-a)}$	thermal resistance from junction to ambient	in free air	[1]	-	-	170	K/W
			[2]	-	-	85	K/W
$R_{th(j-sp)}$	thermal resistance from junction to solder point		-	-	15	K/W	

[1] Device mounted on an FR4 PCB, single-sided copper, tin-plated and standard footprint.

[2] Device mounted on an FR4 PCB, single-sided copper, tin-plated and mounting pad for collector 6 cm².

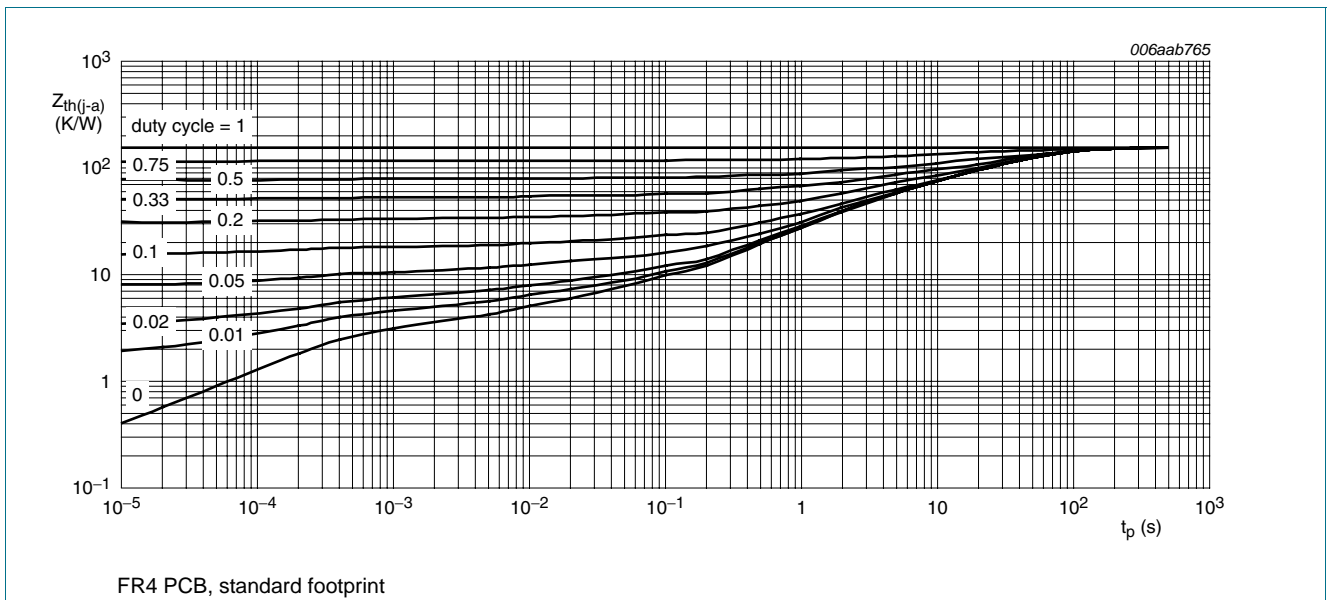

Fig 2. Transient thermal impedance from junction to ambient as a function of pulse duration; typical values

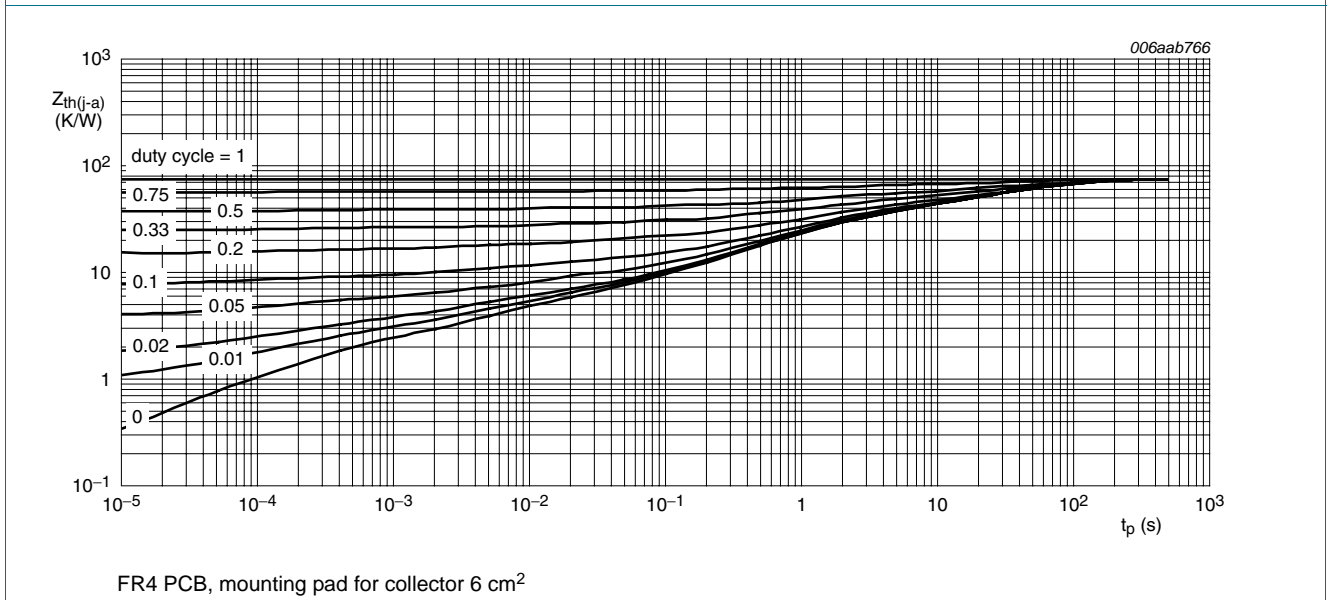

Fig 3. Transient thermal impedance from junction to ambient as a function of pulse duration; typical values

7. Characteristics

Table 7. Characteristics

$T_{amb} = 25\text{ }^{\circ}\text{C}$ unless otherwise specified.

Symbol	Parameter	Conditions	Min	Typ	Max	Unit
I_{CBO}	collector-base cut-off current	$V_{CB} = 320\text{ V}; I_E = 0\text{ A}$	-	-	100	nA
		$V_{CB} = 320\text{ V}; I_E = 0\text{ A}; T_j = 150\text{ }^{\circ}\text{C}$	-	-	10	μA
I_{CES}	collector-emitter cut-off current	$V_{CE} = 320\text{ V}; V_{BE} = 0\text{ V}$	-	-	100	nA
I_{EBO}	emitter-base cut-off current	$V_{EB} = 4\text{ V}; I_C = 0\text{ A}$	-	-	100	nA
h_{FE}	DC current gain	$V_{CE} = 10\text{ V}$				
		$I_C = 50\text{ mA}$	100	155	-	
		$I_C = 100\text{ mA}$	[1] 80	150	-	
		$I_C = 500\text{ mA}$	[1] 35	65	-	
V_{CEsat}	collector-emitter saturation voltage	$I_C = 100\text{ mA}; I_B = 10\text{ mA}$	[1] -	45	80	mV
		$I_C = 100\text{ mA}; I_B = 20\text{ mA}$	[1] -	30	50	mV
		$I_C = 500\text{ mA}; I_B = 100\text{ mA}$	[1] -	85	140	mV
		$I_C = 1\text{ A}; I_B = 200\text{ mA}$	[1] -	150	250	mV
R_{CEsat}	collector-emitter saturation resistance	$I_C = 1\text{ A}; I_B = 200\text{ mA}$	[1] -	150	250	$\text{m}\Omega$
V_{BEsat}	base-emitter saturation voltage	$I_C = 1\text{ A}; I_B = 200\text{ mA}$	[1] -	0.95	1.1	V
t_d	delay time	$V_{CC} = 6\text{ V}; I_C = 0.5\text{ A}; I_{Bon} = 0.1\text{ A}; I_{Boff} = -0.1\text{ A}$	-	25	-	ns
t_r	rise time		-	2820	-	ns
t_{on}	turn-on time		-	2845	-	ns
t_s	storage time		-	2585	-	ns
t_f	fall time		-	1215	-	ns
t_{off}	turn-off time		-	3800	-	ns
f_T	transition frequency	$V_{CE} = 10\text{ V}; I_C = 10\text{ mA}; f = 100\text{ MHz}$	-	25	-	MHz
C_c	collector capacitance	$V_{CB} = 20\text{ V}; I_E = i_e = 0\text{ A}; f = 1\text{ MHz}$	-	12	-	pF
C_e	emitter capacitance	$V_{EB} = 0.5\text{ V}; I_C = i_c = 0\text{ A}; f = 1\text{ MHz}$	-	600	-	pF

[1] Pulse test: $t_p \leq 300\text{ }\mu\text{s}; \delta \leq 0.02$.

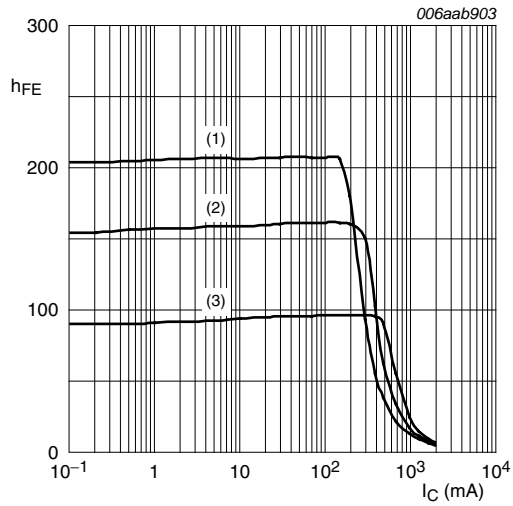

$V_{CE} = 10\text{ V}$
 (1) $T_{amb} = 100^\circ C$
 (2) $T_{amb} = 25^\circ C$
 (3) $T_{amb} = -55^\circ C$

Fig 4. DC current gain as a function of collector current; typical values

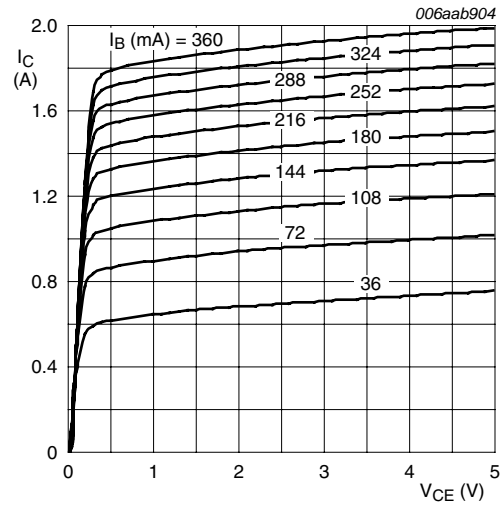

$T_{amb} = 25^\circ C$

Fig 5. Collector current as a function of collector-emitter voltage; typical values

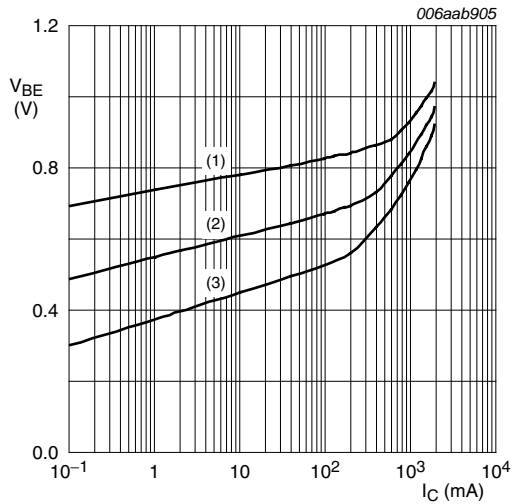

$V_{CE} = 10\text{ V}$
 (1) $T_{amb} = -55^\circ C$
 (2) $T_{amb} = 25^\circ C$
 (3) $T_{amb} = 100^\circ C$

Fig 6. Base-emitter voltage as a function of collector current; typical values

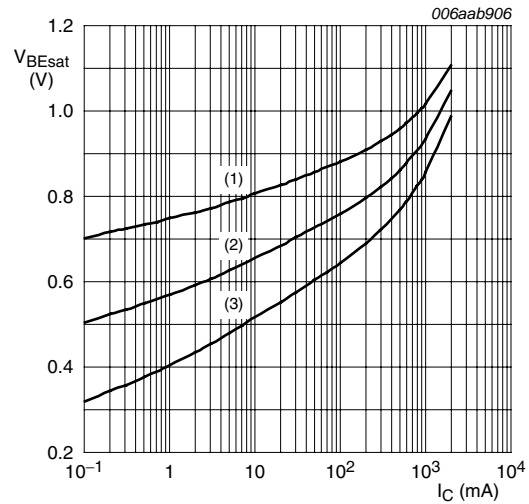

$I_C/I_B = 5$
 (1) $T_{amb} = -55^\circ C$
 (2) $T_{amb} = 25^\circ C$
 (3) $T_{amb} = 100^\circ C$

Fig 7. Base-emitter saturation voltage as a function of collector current; typical values

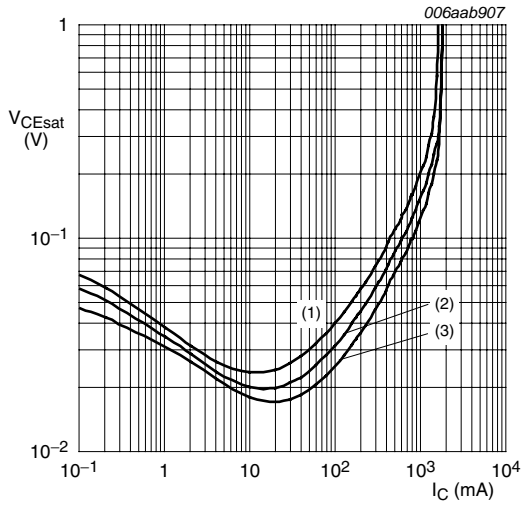

- $I_C/I_B = 5$
- (1) $T_{amb} = 100\text{ }^\circ\text{C}$
 - (2) $T_{amb} = 25\text{ }^\circ\text{C}$
 - (3) $T_{amb} = -55\text{ }^\circ\text{C}$

Fig 8. Collector-emitter saturation voltage as a function of collector current; typical values

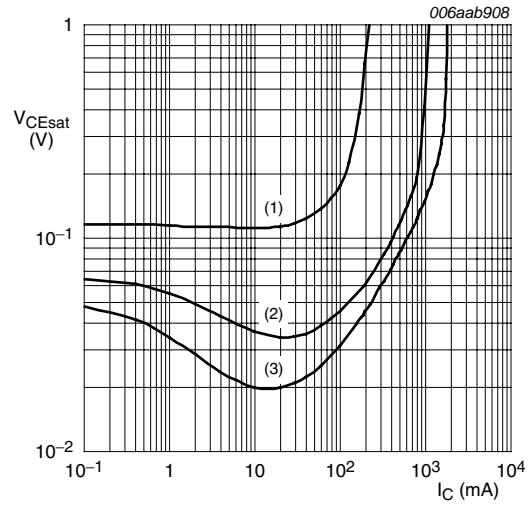

- $T_{amb} = 25\text{ }^\circ\text{C}$
- (1) $I_C/I_B = 20$
 - (2) $I_C/I_B = 10$
 - (3) $I_C/I_B = 5$

Fig 9. Collector-emitter saturation voltage as a function of collector current; typical values

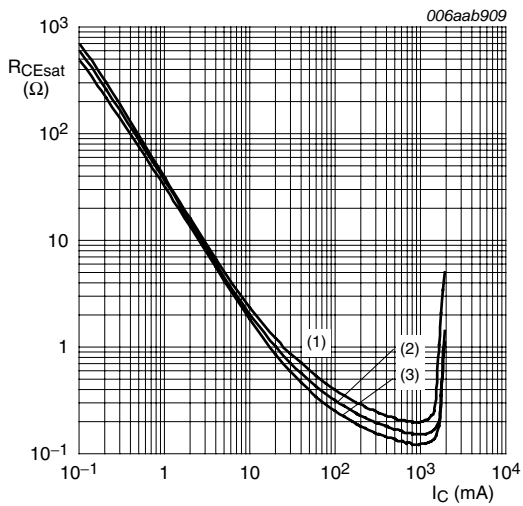

- $I_C/I_B = 5$
- (1) $T_{amb} = 100\text{ }^\circ\text{C}$
 - (2) $T_{amb} = 25\text{ }^\circ\text{C}$
 - (3) $T_{amb} = -55\text{ }^\circ\text{C}$

Fig 10. Collector-emitter saturation resistance as a function of collector current; typical values

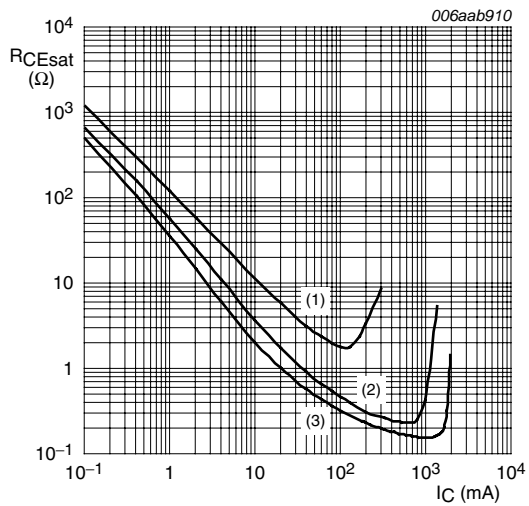

- $T_{amb} = 25\text{ }^\circ\text{C}$
- (1) $I_C/I_B = 20$
 - (2) $I_C/I_B = 10$
 - (3) $I_C/I_B = 5$

Fig 11. Collector-emitter saturation resistance as a function of collector current; typical values

8. Test information

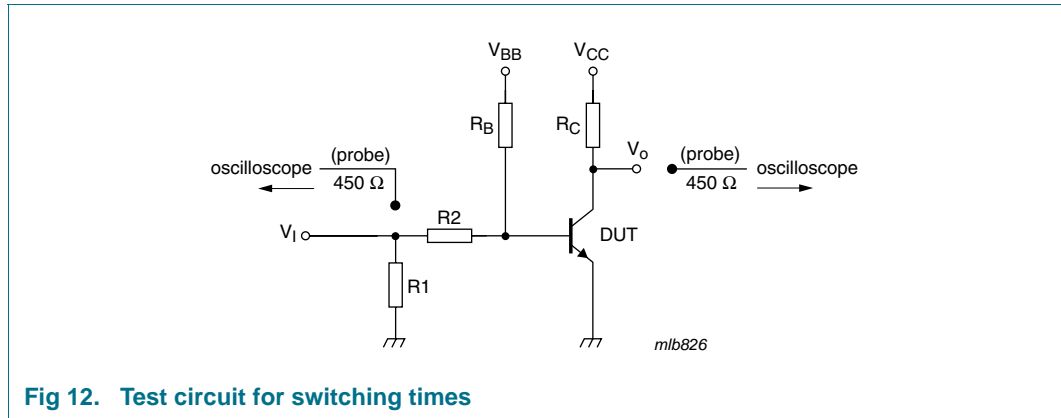

8.1 Quality information

This product has been qualified in accordance with the Automotive Electronics Council (AEC) standard *Q101 - Stress test qualification for discrete semiconductors*, and is suitable for use in automotive applications.

9. Package outline

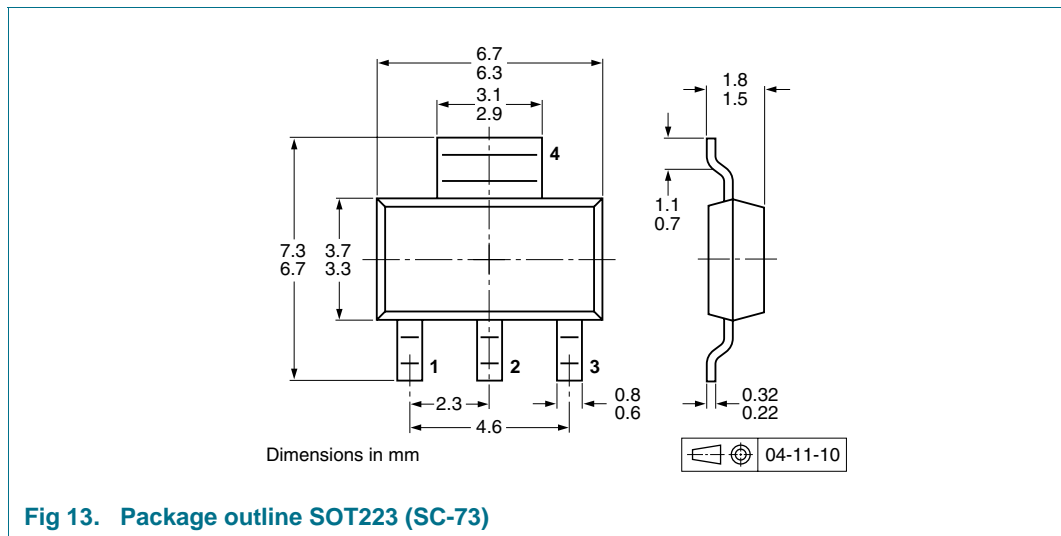

10. Packing information

Table 8. Packing methods

The indicated -xxx are the last three digits of the 12NC ordering code.^[1]

Type number	Package	Description	Packing quantity	
			1000	4000
PBHV8140Z	SOT223	8 mm pitch, 12 mm tape and reel	-115	-135

[1] For further information and the availability of packing methods, see [Section 14](#).

12. Revision history

Table 9. Revision history

Document ID	Release date	Data sheet status	Change notice	Supersedes
PBHV8140Z_1	20091211	Product data sheet	-	-

13. Legal information

13.1 Data sheet status

Document status ^{[1][2]}	Product status ^[3]	Definition
Objective [short] data sheet	Development	This document contains data from the objective specification for product development.
Preliminary [short] data sheet	Qualification	This document contains data from the preliminary specification.
Product [short] data sheet	Production	This document contains the product specification.

[1] Please consult the most recently issued document before initiating or completing a design.

[2] The term 'short data sheet' is explained in section "Definitions".

[3] The product status of device(s) described in this document may have changed since this document was published and may differ in case of multiple devices. The latest product status information is available on the Internet at URL <http://www.nxp.com>.

13.2 Definitions

Draft — The document is a draft version only. The content is still under internal review and subject to formal approval, which may result in modifications or additions. NXP Semiconductors does not give any representations or warranties as to the accuracy or completeness of information included herein and shall have no liability for the consequences of use of such information.

Short data sheet — A short data sheet is an extract from a full data sheet with the same product type number(s) and title. A short data sheet is intended for quick reference only and should not be relied upon to contain detailed and full information. For detailed and full information see the relevant full data sheet, which is available on request via the local NXP Semiconductors sales office. In case of any inconsistency or conflict with the short data sheet, the full data sheet shall prevail.

13.3 Disclaimers

General — Information in this document is believed to be accurate and reliable. However, NXP Semiconductors does not give any representations or warranties, expressed or implied, as to the accuracy or completeness of such information and shall have no liability for the consequences of use of such information.

Right to make changes — NXP Semiconductors reserves the right to make changes to information published in this document, including without limitation specifications and product descriptions, at any time and without notice. This document supersedes and replaces all information supplied prior to the publication hereof.

Suitability for use — NXP Semiconductors products are not designed, authorized or warranted to be suitable for use in medical, military, aircraft, space or life support equipment, nor in applications where failure or malfunction of an NXP Semiconductors product can reasonably be expected to result in personal injury, death or severe property or environmental

damage. NXP Semiconductors accepts no liability for inclusion and/or use of NXP Semiconductors products in such equipment or applications and therefore such inclusion and/or use is at the customer's own risk.

Applications — Applications that are described herein for any of these products are for illustrative purposes only. NXP Semiconductors makes no representation or warranty that such applications will be suitable for the specified use without further testing or modification.

Limiting values — Stress above one or more limiting values (as defined in the Absolute Maximum Ratings System of IEC 60134) may cause permanent damage to the device. Limiting values are stress ratings only and operation of the device at these or any other conditions above those given in the Characteristics sections of this document is not implied. Exposure to limiting values for extended periods may affect device reliability.

Terms and conditions of sale — NXP Semiconductors products are sold subject to the general terms and conditions of commercial sale, as published at <http://www.nxp.com/profile/terms>, including those pertaining to warranty, intellectual property rights infringement and limitation of liability, unless explicitly otherwise agreed to in writing by NXP Semiconductors. In case of any inconsistency or conflict between information in this document and such terms and conditions, the latter will prevail.

No offer to sell or license — Nothing in this document may be interpreted or construed as an offer to sell products that is open for acceptance or the grant, conveyance or implication of any license under any copyrights, patents or other industrial or intellectual property rights.

Export control — This document as well as the item(s) described herein may be subject to export control regulations. Export might require a prior authorization from national authorities.

Quick reference data — The Quick reference data is an extract of the product data given in the Limiting values and Characteristics sections of this document, and as such is not complete, exhaustive or legally binding.

13.4 Trademarks

Notice: All referenced brands, product names, service names and trademarks are the property of their respective owners.

14. Contact information

For more information, please visit: <http://www.nxp.com>

For sales office addresses, please send an email to: salesaddresses@nxp.com

15. Contents

1	Product profile	1
1.1	General description	1
1.2	Features	1
1.3	Applications	1
1.4	Quick reference data	1
2	Pinning information	2
3	Ordering information	2
4	Marking	2
5	Limiting values	3
6	Thermal characteristics	4
7	Characteristics	5
8	Test information	8
8.1	Quality information	8
9	Package outline	8
10	Packing information	8
11	Soldering	9
12	Revision history	10
13	Legal information	11
13.1	Data sheet status	11
13.2	Definitions	11
13.3	Disclaimers	11
13.4	Trademarks	11
14	Contact information	11
15	Contents	12

Please be aware that important notices concerning this document and the product(s) described herein, have been included in section 'Legal information'.



© NXP B.V. 2009.

All rights reserved.

For more information, please visit: <http://www.nxp.com>

For sales office addresses, please send an email to: salesaddresses@nxp.com

Date of release: 11 December 2009

Document identifier: PBHV8140Z_1