

ZPY1 ... ZPY200 (1.3 W)

Silicon-Power-Zener Diodes (non-planar technology) Silizium-Leistungs-Zener-Dioden (flächendiffundierte Dioden)

Version 2015-05-13

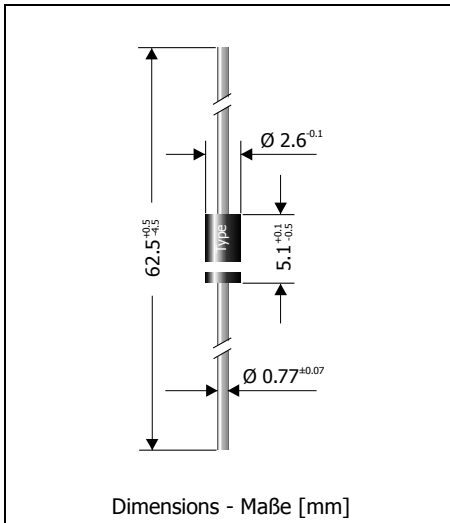

Maximum power dissipation Maximale Verlustleistung	1.3 W
Nominal Z-voltage Nominale Z-Spannung	1...200 V
Plastic case – Kunststoffgehäuse	~ DO-41
Weight approx. – Gewicht ca.	0.4 g
Marking: "Z" plus Zener voltage Stempelung: „Z“ plus Zenerspannung	
Plastic material has UL classification 94V-0 Gehäusematerial UL94V-0 klassifiziert	
Standard packaging taped in ammo pack Standard Lieferform gegurtet in Ammo-Pack	



Standard Zener voltage tolerance is graded to the international E 24 (~ ±5%) standard.
Other voltage tolerances and higher Zener voltages on request.

Die Toleranz der Zener-Spannung ist in der Standard-Ausführung gestuft nach der internationalen Reihe E 24 (~ ±5%). Andere Toleranzen oder höhere Arbeitsspannungen auf Anfrage.

Maximum ratings and Characteristics

Grenz- und Kennwerte

		ZPY-series	
Power dissipation Verlustleistung	$T_A = 50^\circ\text{C}$	P_{tot}	1.3 W ¹⁾
Non repetitive peak power dissipation, $t < 1$ ms Einmalige Impuls-Verlustleistung, $t < 1$ ms	$T_A = 25^\circ\text{C}$	P_{ZSM}	40 W ¹⁾
Operating junction temperature – Sperrschichttemperatur Storage temperature – Lagerungstemperatur		T_j T_s	-50...+150°C -50...+175°C
Thermal resistance junction to ambient air Wärmewiderstand Sperrschicht – umgebende Luft		R_{thA}	<45 K/W ¹⁾
Thermal resistance junction to terminal Wärmewiderstand Sperrschicht – Anschluss		R_{thL}	<15 K/W
Zener voltages see table on next page – Zener-Spannungen siehe Tabelle auf der nächsten Seite			

- Valid, if leads are kept at ambient temperature at a distance of 10 mm from case
Gültig, wenn die Anschlussdrähte in 10 mm Abstand vom Gehäuse auf Umgebungstemperatur gehalten werden
- Tested with pulses – Gemessen mit Impulsen
- The ZPY1 is a diode operated in forward. Hence, the index of all parameters should be "F" instead of "Z".
The cathode, indicated by a white band, has to be connected to the negative pole.
Die ZPY1 ist eine in Durchlass betriebene Si-Diode. Daher ist bei allen Kenn- und Grenzwerten der Index "F" anstatt "Z" zu setzen. Die mit weißem Balken gekennzeichnete Kathode ist mit dem Minuspol zu verbinden.

Maximum ratings and Characteristics

 (T_j = 25°C unless otherwise specified)

Grenz- und Kennwerte

 (T_j = 25°C wenn nicht anders spezifiziert)

Type Typ	Zener voltage ²⁾ Zener-Spannung ²⁾ I _Z = I _{Ztest}		Test current Meßstrom	Dynamic resistance Diff. Widerstand I _{Ztest} / f = 1 kHz	Temp. Coeffic. of Z-voltage ...der Z-Spannung	Reverse volt. Sperrspanng. I _R = 1 µA	Z-current ¹⁾ Z-Strom ¹⁾ T _A = 50°C
	V _{zmin} [V]	V _{zmax} [V]	I _{Ztest} [mA]	r _{zj} [Ω]	α _{vz} [10 ⁻⁴ /°C]	V _R [V]	I _{Zmax} [mA]
ZPY1 ³⁾	0.71	0.82	100	0.5 (<1)	-26...-16	-	1000
ZPY5.6	5.2	6.0	100	1 (<3)	-3...+5	> 0.5 / 3 µA	217
ZPY6.2	5.8	6.6	100	1 (<2)	-1...+6	> 1.5	197
ZPY6.8	6.4	7.2	100	1 (<2)	0...+7	> 2	181
ZPY7.5	7.0	7.9	100	1 (<2)	0...+7	> 2	165
ZPY8.2	7.7	8.7	100	1 (<2)	+3...+8	> 3.5	149
ZPY9.1	8.5	9.6	50	2 (<4)	+3...+8	> 3.5	135
ZPY10	9.4	10.6	50	2 (<4)	+5...+9	> 5	123
ZPY11	10.4	11.6	50	4 (<7)	+5...+10	> 5	112
ZPY12	11.4	12.7	50	4 (<7)	+5...+10	> 7	102
ZPY13	12.4	14.1	50	5 (<10)	+5...+10	> 7	92
ZPY15	13.8	15.6	50	5 (<10)	+5...+10	> 10	83
ZPY16	15.3	17.1	25	6 (<15)	+6...+11	> 10	76
ZPY18	16.8	19.1	25	6 (<15)	+6...+11	> 10	68
ZPY20	18.8	21.2	25	6 (<15)	+6...+11	> 10	61
ZPY22	20.8	23.3	25	6 (<15)	+6...+11	> 12	56
ZPY24	22.8	25.6	25	7 (<15)	+6...+11	> 12	51
ZPY27	25.1	28.9	25	7 (<15)	+6...+11	> 14	45
ZPY30	28	32	25	8 (<15)	+6...+11	> 14	41
ZPY33	31	35	25	8 (<15)	+6...+11	> 17	37
ZPY36	34	38	10	16 (<40)	+6...+11	> 17	34
ZPY39	37	41	10	20 (<40)	+6...+11	> 20	32
ZPY43	40	46	10	24 (<45)	+7...+12	> 20	28
ZPY47	44	50	10	24 (<45)	+7...+12	> 24	26
ZPY51	48	54	10	25 (<60)	+7...+12	> 24	24
ZPY56	52	60	10	25 (<60)	+7...+12	> 28	22
ZPY62	58	66	10	25 (<80)	+8...+13	> 28	20
ZPY68	64	72	10	25 (<80)	+8...+13	> 34	18
ZPY75	70	79	10	30 (<100)	+8...+13	> 34	16
ZPY82	77	88	10	30 (<100)	+8...+13	> 41	15
ZPY91	85	96	5	40 (<200)	+9...+13	> 41	14
ZPY100	94	106	5	60 (<200)	+9...+13	> 50	12
ZPY110	104	116	5	80 (<250)	+9...+13	> 50	11
ZPY120	114	127	5	80 (<250)	+9...+13	> 60	10
ZPY130	124	141	5	90 (<300)	+9...+13	> 60	9
ZPY150	138	156	5	100 (<300)	+9...+13	> 75	8
ZPY160	153	171	5	110 (<350)	+9...+13	> 75	8
ZPY180	168	191	5	120 (<350)	+9...+13	> 90	7
ZPY200	188	212	5	150 (<350)	+9...+13	> 90	6

1 Notes see previous page – Fußnoten siehe vorhergehende Seite

ZPY1 ... ZPY200 (1.3 W)

