

# ALM-38140

## 50MHz – 4GHz PIN Diode Variable Attenuator Module

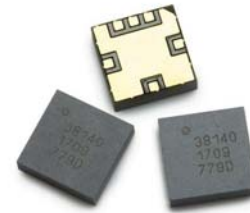

### Data Sheet



#### Description

Avago Technologies' ALM-38140 is a fully matched wideband variable attenuator module with high linearity performance and high dynamic range. The high dynamic range and low phase shift can be achieved with only one external inductor place between Linput and Loutput.

ALM-38140 is a fully integrated solution using Avago Technologies' low distortion silicon PIN diodes housed in a miniature 3.8 x 3.8 x 1.0 mm<sup>3</sup> MCOB (Multiple-Chips-On-Board) package.

This variable attenuator module is easily operated with a constant voltage,  $V_{supply} = 2.7V$  and a control voltage,  $V_{control} = 0.8 - 5V$ . No external biasing components needed.

ALM-38140 is ideal for gain control in RF amplifier circuits.

#### Package Marking

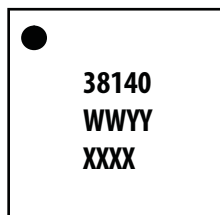

Top View

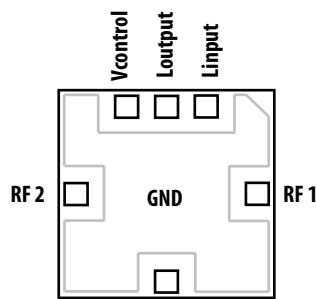

Bottom View

Note:

Package marking provides orientation and identification

"38140" = Device Part Number

"WWYY" = Work week and year of manufacture

"XXXX" = Last 4 digit of assembly lot number

\* RF1 and RF2 can be used either as RF input or RF output as they are symmetrical.

#### Features

- Fully integrated module
- High dynamic range
- Excellent Input IP3 performance
- High Input P1dB compression
- Low phase shift performance
- Tape-and-Reel packaging option available

#### Specifications

##### Typical Performance at 1.9GHz

- Attenuation : 39dB
- Insertion Loss : 3.2dB
- Input IP3 : 50dBm
- Input P1dB : > 30dBm

#### Applications

- Broadband system applications; such as CATV, WCDMA, VSAT, WIMAX, Cellular base station.
- General purpose voltage controlled attenuator for low current applications.
- Temperature compensation circuitry
- Automatic Gain Control



**Attention: Observe precautions for handling electrostatic sensitive devices.**

ESD Machine Model = 300 V

ESD Human Body Model = 900 V

Refer to Avago Application Note A004R:

Electrostatic Discharge, Damage and Control.

### ALM-38140 Absolute Maximum Rating <sup>[1]</sup> T<sub>A</sub> = 25°C

| Symbol                    | Parameter               | Unit | Absolute Maximum                      |
|---------------------------|-------------------------|------|---------------------------------------|
| I <sub>supply, max</sub>  | Supply Current          | mA   | 18.0                                  |
| I <sub>control, max</sub> | Control Current         | mA   | 33.4                                  |
| P <sub>in, max</sub>      | RF Input Power          | dBm  | 27dBm CW, 36dBm with 12.5% duty cycle |
| P <sub>diss</sub>         | Total Power Dissipation | W    | 0.3                                   |
| T <sub>j</sub>            | Junction Temperature    | °C   | 150                                   |
| T <sub>stg</sub>          | Storage Temperature     | °C   | -60 to 150                            |

**Thermal Resistance <sup>[2]</sup> θ<sub>jc</sub> = 106.3°C/W**  
(V<sub>c</sub> = 1V, V<sub>supply</sub> = 2.7V, T<sub>c</sub> = 85°C)

Notes:

1. Operation in excess of any one of these limits may result in permanent damage to the device.
2. Thermal resistance is measured from junction to case using Infra-Red method.

### Electrical Specifications, V<sub>supply</sub> = 2.7V, T<sub>A</sub> = 25°C, Z<sub>0</sub> = 50Ω

| Symbol               | Parameter and Test Condition                                | Frequency (MHz) | Unit    | Min  | Typ  | Max |
|----------------------|---|-----------------|---------|------|------|-----|
| I <sub>supply</sub>  | Supply Current drain (V <sub>control</sub> = 1V)            |                 | mA      | –    | 2.5  | –   |
| I <sub>control</sub> | Control Current drain (V <sub>control</sub> = 5V)           |                 | mA      | –    | 20.5 | –   |
| S21                  | Maximum Attenuation (V <sub>control</sub> = 1V)             | 900             | dB      | –    | 42.0 | –   |
| S21                  | Maximum Attenuation (V <sub>control</sub> = 1V)             | 1900            | dB      | 36.0 | 39.0 | –   |
| S21                  | Insertion Loss (V <sub>control</sub> = 5V)                  | 900             | dB      | –    | 2.8  | –   |
| S21                  | Insertion Loss (V <sub>control</sub> = 5V)                  | 1900            | dB      | –    | 3.2  | 3.7 |
|                      | Dynamic Range   | 900             | dB      | –    | 38   | –   |
|                      | Dynamic Range   | 1900            | dB      | 33   | 36.5 | –   |
| IRL                  | Input Return Loss (V <sub>control</sub> = 5V)               | 1900            | dB      | 10   | 14.5 | –   |
| ORL                  | Output Return Loss (V <sub>control</sub> = 5V)              | 1900            | dB      | 10   | 13.5 | –   |
| IIP3 <sup>[5]</sup>  | Input Third Order Intercept Point                           | 900             | dBm     | –    | 50   | –   |
| IIP3 <sup>[5]</sup>  | Input Third Order Intercept Point                           | 1900            | dBm     | –    | 50   | –   |
| IP1dB <sup>[6]</sup> | Input Power at P1dB Compression (V <sub>control</sub> = 5V) | 900             | dBm     | –    | 32   | –   |
| IP1dB <sup>[6]</sup> | Input Power at P1dB Compression (V <sub>control</sub> = 5V) | 1900            | dBm     | –    | 33   | –   |
|                      | Phase Shift (V <sub>control</sub> = 1V)                     | 1900            | degrees | –    | 10.5 | –   |

Notes:

4. Data above is obtained using demo board shown in Figure 32 and 33.
5. 2-tone IIP3 test condition: F<sub>RF1</sub>, F<sub>RF2</sub> = 1.1MHz separation, Input power = 22dBm
6. IP1dB measured with 12.5% duty cycle.
7. The performance above obtained with phase compensation inductor value based on the table 1 below.
8. Use proper biasing, heat sink and de-rating to ensure maximum channel temperature is not exceeded. See absolute maximum ratings and application note (if applicable) for more details.

## ALM-38140 Typical Broadband S-Parameters

(Vsupply = 2.7V, Vctrl = 1V, Tc = 25°C, matched 50Ω)

| Freq<br>GHz | S11  |        |        | S21  |        |        | S12  |        |        | S22  |        |        |
|-------------|------|--------|--------|------|--------|--------|------|--------|--------|------|--------|--------|
|             | Mag. | dB.    | Ang.   | Mag. | dB.    | Ang.   | Mag. | dB.    | Ang.   | Mag. | dB.    | Ang.   |
| 0.05        | 0.14 | -17.21 | -175.1 | 0.01 | -43.21 | 43.6   | 0.01 | -43.10 | 43.5   | 0.13 | -17.64 | -173.8 |
| 0.1         | 0.14 | -17.23 | 176.3  | 0.01 | -41.98 | 19.5   | 0.01 | -42.00 | 19.5   | 0.13 | -17.68 | 177.8  |
| 0.2         | 0.14 | -17.32 | 165.5  | 0.01 | -41.46 | 7.1    | 0.01 | -41.54 | 7.7    | 0.13 | -17.75 | 167.6  |
| 0.3         | 0.13 | -17.50 | 155.6  | 0.01 | -41.12 | 1.3    | 0.01 | -41.13 | 1.2    | 0.13 | -17.85 | 159.5  |
| 0.4         | 0.13 | -17.62 | 147.0  | 0.01 | -40.73 | -3.6   | 0.01 | -40.74 | -3.6   | 0.13 | -18.03 | 152.3  |
| 0.5         | 0.13 | -17.81 | 139.2  | 0.01 | -40.38 | -8.1   | 0.01 | -40.40 | -8.1   | 0.12 | -18.30 | 145.8  |
| 0.6         | 0.12 | -18.06 | 131.5  | 0.01 | -40.03 | -12.4  | 0.01 | -39.97 | -12.4  | 0.12 | -18.59 | 139.2  |
| 0.7         | 0.12 | -18.35 | 123.2  | 0.01 | -39.56 | -16.4  | 0.01 | -39.62 | -16.6  | 0.11 | -18.88 | 132.4  |
| 0.8         | 0.12 | -18.55 | 115.4  | 0.01 | -39.19 | -21.2  | 0.01 | -39.19 | -20.9  | 0.11 | -19.18 | 125.8  |
| 0.9         | 0.11 | -18.88 | 108.4  | 0.01 | -38.68 | -25.3  | 0.01 | -38.68 | -25.3  | 0.11 | -19.51 | 119.5  |
| 1           | 0.11 | -19.38 | 100.6  | 0.01 | -38.13 | -30.4  | 0.01 | -38.13 | -30.4  | 0.10 | -19.88 | 113.6  |
| 1.1         | 0.10 | -19.78 | 92.2   | 0.01 | -37.61 | -35.7  | 0.01 | -37.59 | -35.5  | 0.10 | -20.30 | 108.2  |
| 1.2         | 0.10 | -20.11 | 85.2   | 0.01 | -37.07 | -41.1  | 0.01 | -37.04 | -41.3  | 0.09 | -20.84 | 103.5  |
| 1.3         | 0.09 | -20.71 | 79.3   | 0.01 | -36.49 | -47.3  | 0.01 | -36.50 | -47.0  | 0.08 | -21.52 | 99.0   |
| 1.4         | 0.08 | -21.61 | 72.7   | 0.02 | -35.98 | -53.1  | 0.02 | -35.96 | -53.2  | 0.08 | -22.27 | 93.8   |
| 1.5         | 0.08 | -22.49 | 64.6   | 0.02 | -35.40 | -59.7  | 0.02 | -35.40 | -59.6  | 0.07 | -22.87 | 88.5   |
| 1.6         | 0.07 | -23.16 | 57.3   | 0.02 | -34.90 | -66.0  | 0.02 | -34.93 | -66.2  | 0.07 | -23.24 | 85.0   |
| 1.7         | 0.06 | -23.92 | 53.0   | 0.02 | -34.35 | -73.0  | 0.02 | -34.38 | -72.8  | 0.07 | -23.64 | 85.0   |
| 1.8         | 0.05 | -25.27 | 50.7   | 0.02 | -33.85 | -80.0  | 0.02 | -33.86 | -79.8  | 0.06 | -24.35 | 86.7   |
| 1.9         | 0.04 | -27.06 | 47.5   | 0.02 | -33.36 | -86.9  | 0.02 | -33.35 | -87.0  | 0.05 | -25.24 | 87.2   |
| 2           | 0.04 | -28.95 | 43.5   | 0.02 | -32.86 | -94.2  | 0.02 | -32.90 | -94.2  | 0.05 | -25.74 | 85.4   |
| 2.1         | 0.03 | -30.32 | 42.8   | 0.02 | -32.45 | -101.1 | 0.02 | -32.44 | -101.0 | 0.05 | -25.50 | 84.1   |
| 2.2         | 0.03 | -31.50 | 52.5   | 0.03 | -31.86 | -108.7 | 0.03 | -31.86 | -108.7 | 0.06 | -24.85 | 85.9   |
| 2.3         | 0.02 | -32.14 | 72.7   | 0.03 | -31.44 | -116.5 | 0.03 | -31.41 | -116.4 | 0.06 | -24.16 | 88.5   |
| 2.4         | 0.03 | -31.61 | 93.4   | 0.03 | -30.97 | -124.2 | 0.03 | -30.96 | -124.0 | 0.07 | -23.60 | 89.0   |
| 2.5         | 0.03 | -30.43 | 102.9  | 0.03 | -30.54 | -131.6 | 0.03 | -30.52 | -131.6 | 0.07 | -22.98 | 86.7   |
| 2.6         | 0.04 | -28.44 | 101.9  | 0.03 | -30.07 | -139.7 | 0.03 | -30.05 | -139.7 | 0.08 | -22.16 | 82.6   |
| 2.7         | 0.05 | -26.30 | 98.6   | 0.03 | -29.60 | -146.4 | 0.03 | -29.61 | -146.5 | 0.09 | -21.31 | 78.2   |
| 2.8         | 0.06 | -24.35 | 96.5   | 0.04 | -29.08 | -155.1 | 0.04 | -29.07 | -155.0 | 0.10 | -20.38 | 72.5   |
| 2.9         | 0.07 | -23.06 | 92.8   | 0.04 | -28.63 | -163.2 | 0.04 | -28.63 | -163.1 | 0.11 | -19.48 | 65.1   |
| 3           | 0.08 | -22.00 | 85.2   | 0.04 | -28.18 | -171.5 | 0.04 | -28.15 | -171.5 | 0.12 | -18.49 | 58.1   |
| 3.5         | 0.13 | -17.56 | 41.6   | 0.05 | -25.81 | 146.0  | 0.05 | -25.80 | 146.0  | 0.18 | -14.88 | 14.6   |
| 4           | 0.19 | -14.61 | -10.1  | 0.07 | -23.54 | 101.2  | 0.07 | -23.53 | 101.3  | 0.25 | -11.88 | -36.3  |
| 4.5         | 0.25 | -12.02 | -66.3  | 0.09 | -21.00 | 51.4   | 0.09 | -21.00 | 51.4   | 0.35 | -9.12  | -89.3  |
| 5           | 0.35 | -9.20  | -125.3 | 0.11 | -19.02 | -6.1   | 0.11 | -19.01 | -6.1   | 0.48 | -6.34  | -144.1 |
| 5.5         | 0.48 | -6.44  | 176.4  | 0.12 | -18.29 | -67.2  | 0.12 | -18.31 | -67.2  | 0.62 | -4.13  | 159.5  |
| 6           | 0.61 | -4.35  | 120.7  | 0.11 | -19.03 | -126.7 | 0.11 | -19.03 | -126.8 | 0.72 | -2.84  | 104.4  |

Notes:

9. S-parameter is measured with reference plane at SMA end launch using demo board shown in Figure 33.
10. Demo board 50Ω transmission line is CPWG with W = 23 mils, G = 18.5 mils, L = 383.7 mils, 10 mils Rogers RO4350, 0.5oz Cu.
11. Demo board SMA end launch is Johnson 142-0701-851.
12. The above performance is with board loss removed.

## ALM-38140 Typical Broadband S-Parameters

(Vsupply = 2.7V, Vctrl = 5V, Tc = 25°C, matched 50Ω)

| Freq<br>GHz | S11  |        |        | S21  |       |        | S12  |       |        | S22  |        |        |
|-------------|------|--------|--------|------|-------|--------|------|-------|--------|------|--------|--------|
|             | Mag. | dB.    | Ang.   | Mag. | dB.   | Ang.   | Mag. | dB    | Ang.   | Mag. | dB.    | Ang.   |
| 0.05        | 0.04 | -28.48 | 103.9  | 0.74 | -2.64 | 0.3    | 0.74 | -2.62 | 0.2    | 0.03 | -29.15 | 102.3  |
| 0.1         | 0.01 | -36.56 | 153.6  | 0.73 | -2.67 | -7.8   | 0.73 | -2.68 | -7.8   | 0.01 | -36.95 | 158.3  |
| 0.2         | 0.02 | -33.27 | -144.2 | 0.73 | -2.69 | -19.2  | 0.73 | -2.69 | -19.2  | 0.02 | -33.01 | -141.8 |
| 0.3         | 0.04 | -28.98 | -134.9 | 0.73 | -2.72 | -29.6  | 0.73 | -2.72 | -29.7  | 0.04 | -28.32 | -133.0 |
| 0.4         | 0.05 | -25.79 | -138.3 | 0.73 | -2.73 | -39.9  | 0.73 | -2.73 | -39.9  | 0.06 | -25.01 | -135.2 |
| 0.5         | 0.07 | -23.43 | -144.4 | 0.73 | -2.74 | -50.0  | 0.73 | -2.76 | -50.0  | 0.07 | -22.65 | -140.7 |
| 0.6         | 0.08 | -21.61 | -152.2 | 0.73 | -2.77 | -60.0  | 0.73 | -2.76 | -60.0  | 0.09 | -21.00 | -147.6 |
| 0.7         | 0.10 | -20.34 | -160.9 | 0.73 | -2.79 | -70.0  | 0.72 | -2.79 | -70.0  | 0.10 | -19.60 | -155.1 |
| 0.8         | 0.11 | -19.11 | -170.0 | 0.72 | -2.83 | -80.0  | 0.72 | -2.82 | -80.0  | 0.12 | -18.40 | -163.7 |
| 0.9         | 0.12 | -18.09 | -178.7 | 0.72 | -2.84 | -90.0  | 0.72 | -2.84 | -90.0  | 0.13 | -17.41 | -172.9 |
| 1           | 0.14 | -17.34 | 172.5  | 0.72 | -2.87 | -99.8  | 0.72 | -2.87 | -99.9  | 0.15 | -16.64 | 177.7  |
| 1.1         | 0.15 | -16.70 | 162.8  | 0.72 | -2.91 | -109.8 | 0.72 | -2.91 | -109.8 | 0.16 | -15.92 | 168.9  |
| 1.2         | 0.16 | -16.03 | 152.5  | 0.71 | -2.94 | -119.6 | 0.71 | -2.94 | -119.7 | 0.17 | -15.25 | 160.4  |
| 1.3         | 0.17 | -15.42 | 143.4  | 0.71 | -2.97 | -129.5 | 0.71 | -2.97 | -129.5 | 0.18 | -14.69 | 151.5  |
| 1.4         | 0.18 | -15.06 | 134.9  | 0.71 | -3.01 | -139.4 | 0.71 | -3.00 | -139.4 | 0.19 | -14.32 | 142.5  |
| 1.5         | 0.18 | -14.82 | 126.0  | 0.71 | -3.03 | -149.2 | 0.70 | -3.04 | -149.2 | 0.20 | -14.03 | 133.0  |
| 1.6         | 0.19 | -14.43 | 116.3  | 0.70 | -3.07 | -159.1 | 0.70 | -3.05 | -159.1 | 0.21 | -13.63 | 123.6  |
| 1.7         | 0.20 | -14.02 | 106.8  | 0.70 | -3.11 | -168.9 | 0.70 | -3.11 | -168.9 | 0.22 | -13.21 | 115.0  |
| 1.8         | 0.21 | -13.76 | 98.1   | 0.70 | -3.15 | -178.7 | 0.70 | -3.15 | -178.7 | 0.22 | -12.96 | 106.6  |
| 1.9         | 0.21 | -13.72 | 89.7   | 0.69 | -3.17 | 171.5  | 0.69 | -3.17 | 171.5  | 0.23 | -12.93 | 97.7   |
| 2           | 0.21 | -13.70 | 80.8   | 0.69 | -3.19 | 161.6  | 0.69 | -3.19 | 161.5  | 0.23 | -12.87 | 88.4   |
| 2.1         | 0.21 | -13.56 | 71.4   | 0.69 | -3.23 | 151.6  | 0.69 | -3.24 | 151.7  | 0.23 | -12.66 | 79.1   |
| 2.2         | 0.21 | -13.38 | 62.5   | 0.69 | -3.28 | 141.8  | 0.69 | -3.27 | 141.8  | 0.24 | -12.43 | 70.3   |
| 2.3         | 0.21 | -13.36 | 54.1   | 0.68 | -3.29 | 131.9  | 0.68 | -3.32 | 131.9  | 0.24 | -12.38 | 61.8   |
| 2.4         | 0.21 | -13.53 | 45.7   | 0.68 | -3.33 | 122.1  | 0.68 | -3.34 | 122.1  | 0.24 | -12.48 | 53.2   |
| 2.5         | 0.21 | -13.67 | 36.3   | 0.68 | -3.36 | 112.1  | 0.68 | -3.36 | 112.1  | 0.24 | -12.48 | 44.4   |
| 2.6         | 0.21 | -13.71 | 27.0   | 0.68 | -3.40 | 102.2  | 0.67 | -3.42 | 102.2  | 0.24 | -12.43 | 35.4   |
| 2.7         | 0.21 | -13.68 | 18.4   | 0.67 | -3.43 | 92.2   | 0.67 | -3.44 | 92.2   | 0.24 | -12.41 | 26.3   |
| 2.8         | 0.20 | -13.79 | 9.8    | 0.67 | -3.47 | 82.2   | 0.67 | -3.47 | 82.2   | 0.24 | -12.40 | 17.2   |
| 2.9         | 0.20 | -13.98 | 0.3    | 0.67 | -3.53 | 72.1   | 0.67 | -3.53 | 72.2   | 0.24 | -12.34 | 8.3    |
| 3           | 0.20 | -14.04 | -9.9   | 0.66 | -3.59 | 62.1   | 0.66 | -3.59 | 62.1   | 0.24 | -12.24 | -0.2   |
| 3.5         | 0.19 | -14.42 | -57.0  | 0.64 | -3.89 | 11.1   | 0.64 | -3.89 | 11.0   | 0.26 | -11.64 | -45.1  |
| 4           | 0.18 | -14.77 | -104.2 | 0.61 | -4.28 | -41.3  | 0.61 | -4.28 | -41.3  | 0.29 | -10.79 | -90.3  |
| 4.5         | 0.17 | -15.15 | -148.6 | 0.57 | -4.82 | -94.7  | 0.57 | -4.82 | -94.7  | 0.32 | -9.91  | -135.4 |
| 5           | 0.18 | -14.73 | 175.9  | 0.53 | -5.45 | -150.7 | 0.53 | -5.44 | -150.6 | 0.37 | -8.62  | -176.9 |
| 5.5         | 0.23 | -12.76 | 151.6  | 0.46 | -6.66 | 148.9  | 0.46 | -6.67 | 149.0  | 0.46 | -6.75  | 142.6  |
| 6           | 0.38 | -8.42  | 118.0  | 0.35 | -9.23 | 85.5   | 0.35 | -9.24 | 85.5   | 0.58 | -4.76  | 98.5   |

## ALM-38140 Typical Broadband Performance at 25°C

(Vsupply = 2.7V, Vctrl = 1V - 5V)

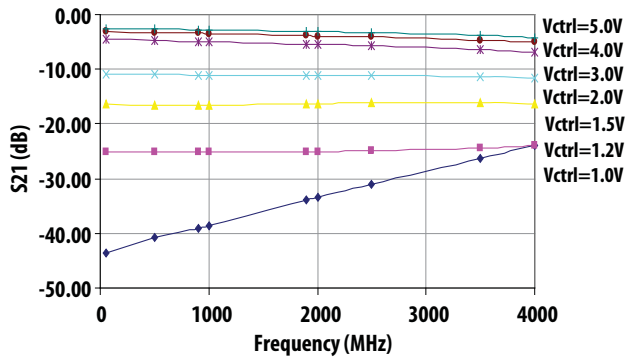

Figure 1. S21 Vs Frequency as function of Vctrl

## ALM-38140 Typical Over-Temperature Broadband Performance

(Vsupply = 2.7V, Vctrl = 1V & 5V)

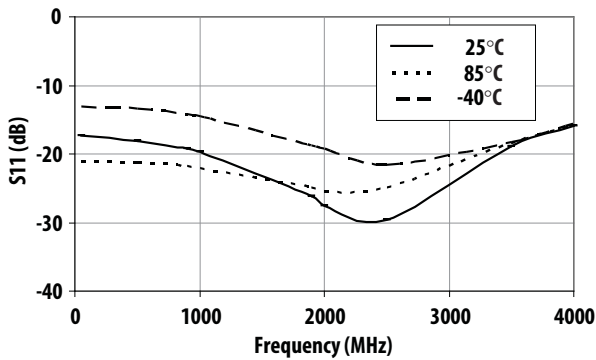

Figure 2. S11 (Return Loss) at Vctrl=1V vs Frequency vs Temperature

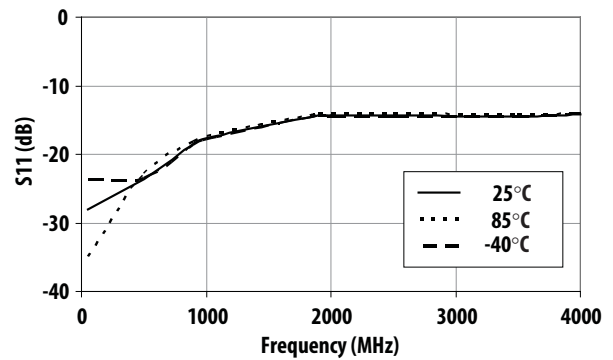

Figure 3. S11 (Return Loss) at Vctrl=5V vs Frequency vs Temperature

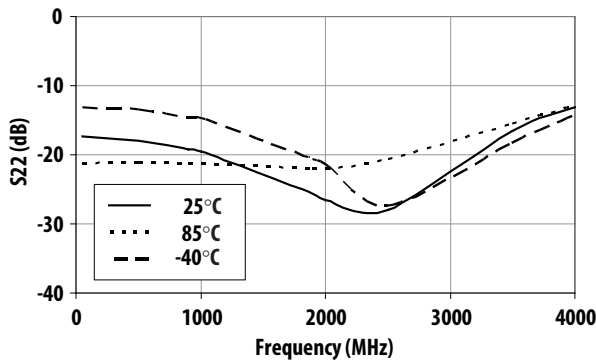

Figure 4. S22 (Return Loss) at Vctrl=1V vs Frequency vs Temperature

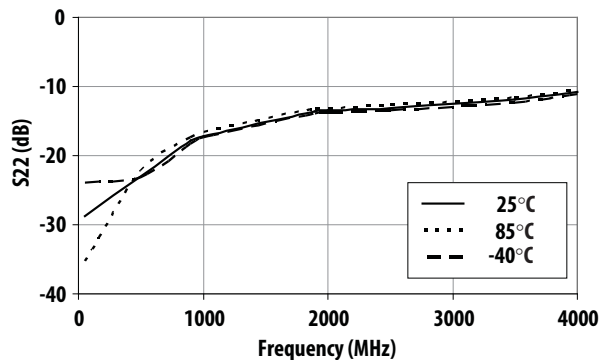

Figure 5. S22 (Return Loss) at Vctrl=5V vs Frequency vs Temperature

## ALM-38140 Typical Over-Temperature Broadband Performance

(Vsupply = 2.7 V, Vctrl = 0.8 V & 5 V)

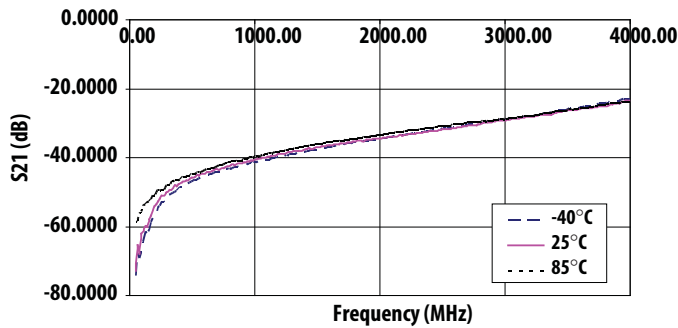

Figure 6. S21 at Vctrl=0.8V (Attenuation) vs Frequency vs Temperature

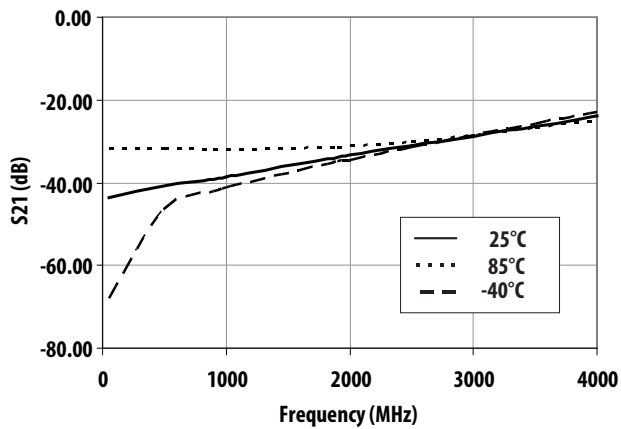

Figure 7. S21 at Vctrl=1V (Attenuation) vs Frequency vs Temperature

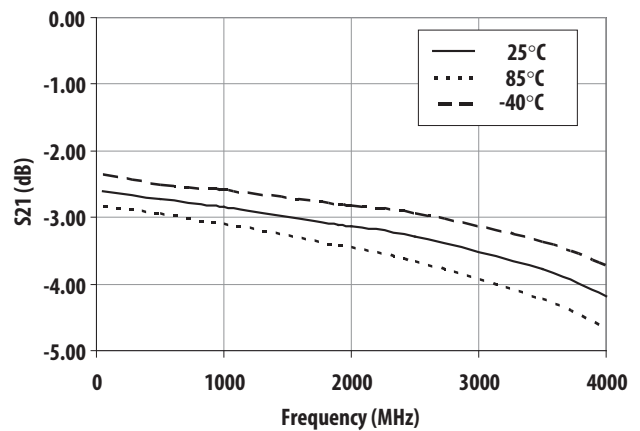

Figure 8. S21 at Vctrl=5V (Insertion Loss) vs Frequency vs Temperature

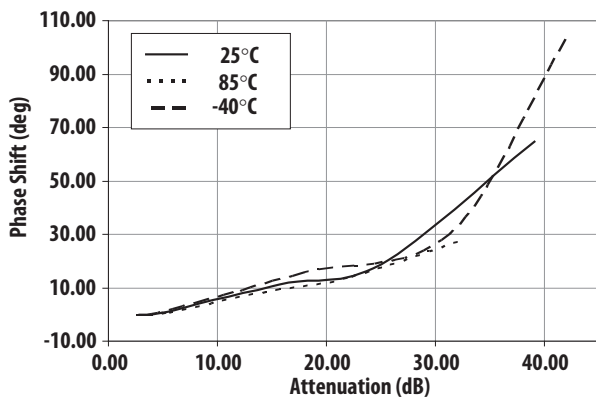

Figure 9. Phase shift vs Attenuation vs Temperature at 900MHz

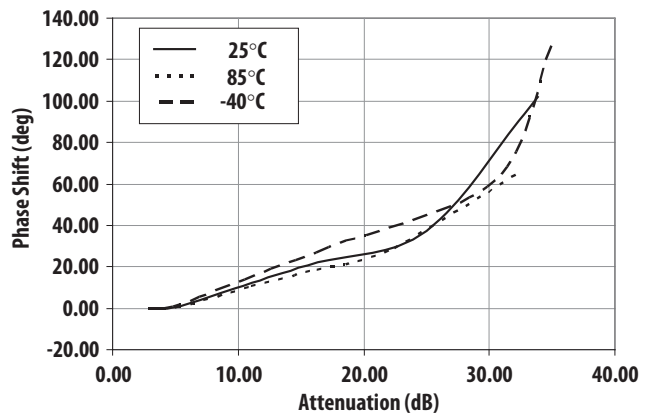

Figure 10. Phase shift vs Attenuation vs Temperature at 1900MHz

# ALM-38140 Typical Over-Temperature Broadband Performance

(Vsupply = 2.7 V, Vctrl = 1 V & 5 V)

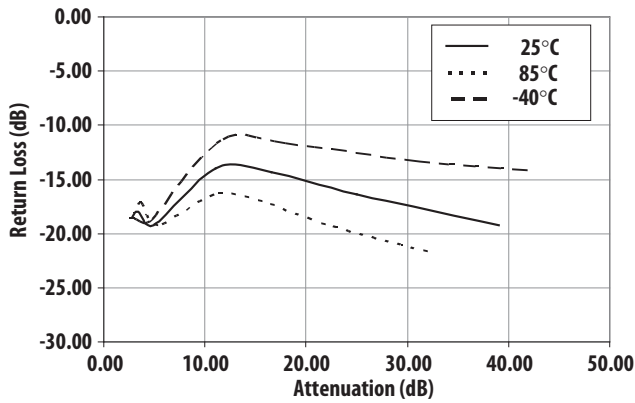

Figure 11. Return loss vs Attenuation vs Temperature at 900MHZ

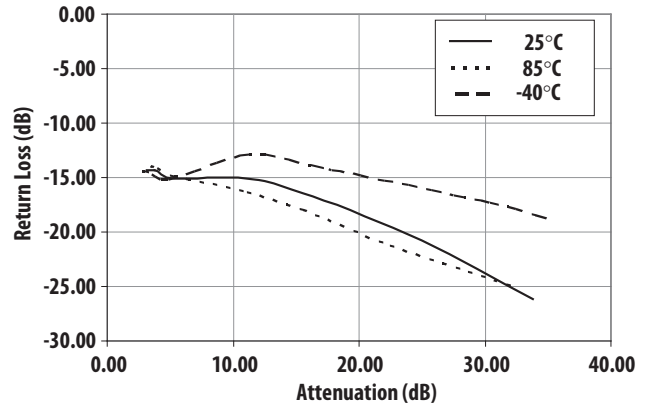

Figure 12. Return loss vs Attenuation vs Temperature at 1900MHZ

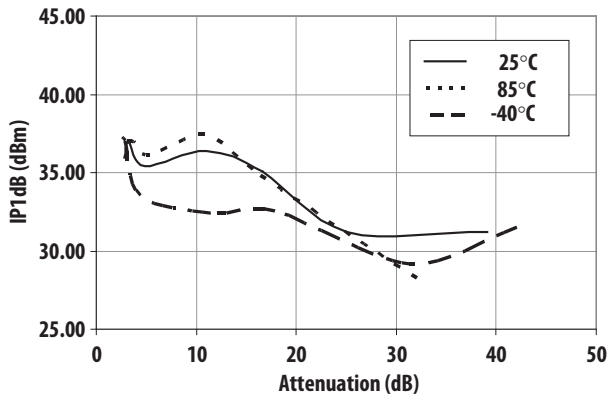

Figure 13. Input P1dB vs Attenuation vs Temperature at 900MHZ

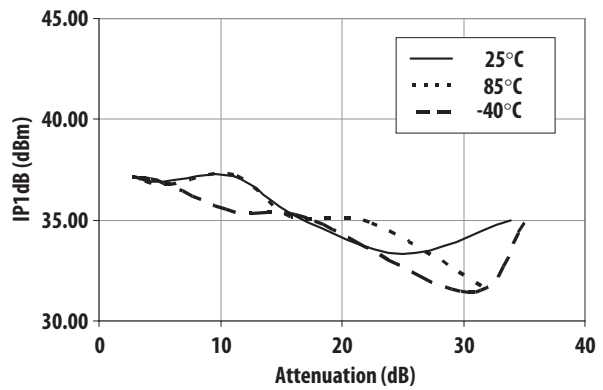

Figure 14. Input P1dB vs Attenuation vs Temperature at 1900MHZ

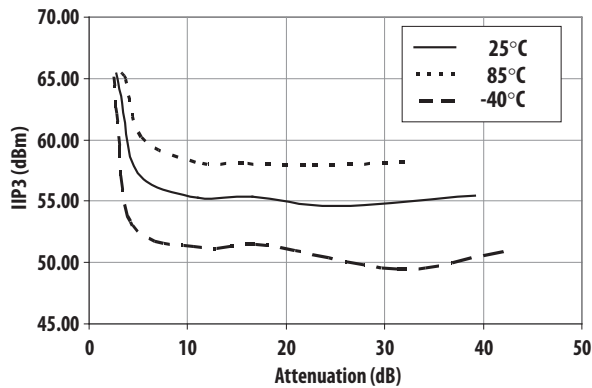

Figure 15. Input IP3 vs Attenuation vs Temperature at 900MHZ

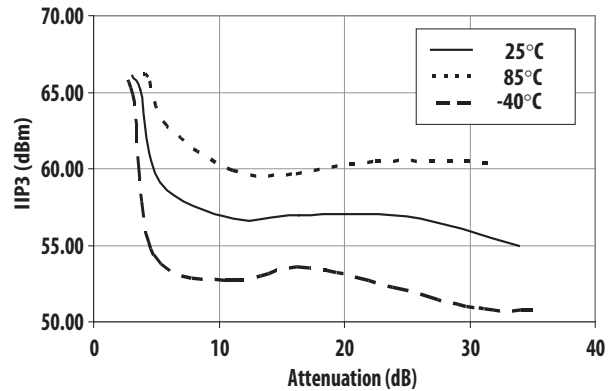

Figure 16. Input IP3 vs Attenuation vs Temperature at 1900MHZ

## ALM-38140 Typical Over-Temperature With Phase Compensation Coil Performance

( $V_{supply} = 2.7\text{ V}$ ,  $V_{ctrl} = 1\text{ V}$  &  $5\text{ V}$ )

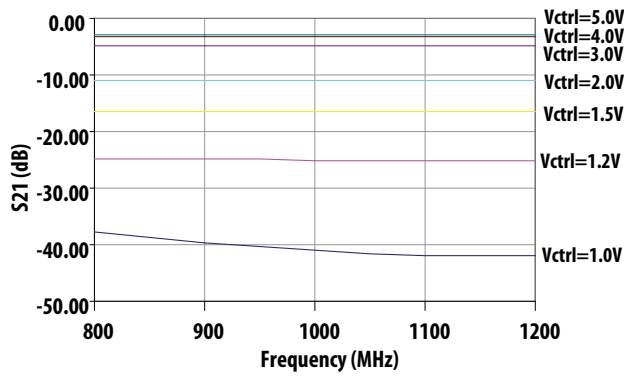

Figure 17. S21 Vs Frequency as function of  $V_{ctrl}$  at  $F_c = 1\text{ GHz}$

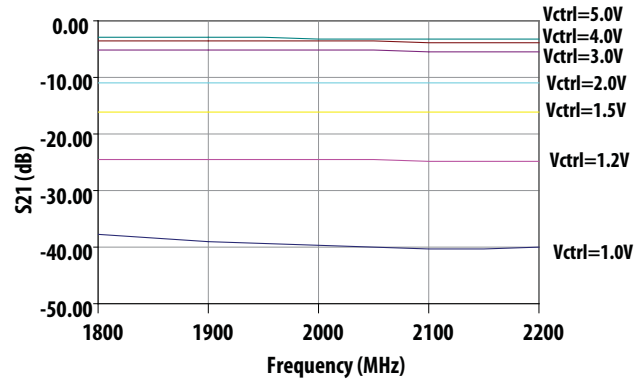

Figure 18. S21 Vs Frequency as function of  $V_{ctrl}$  at  $F_c = 2\text{ GHz}$

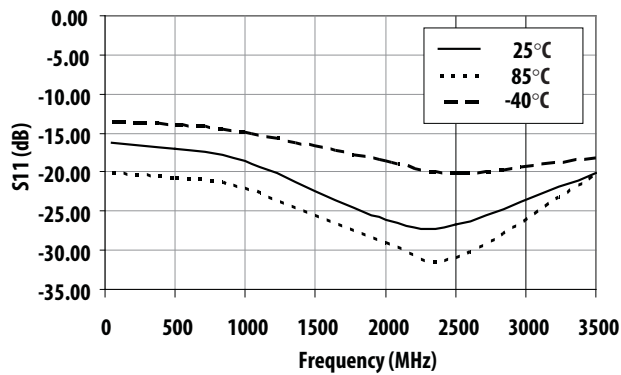

Figure 19. S11 (Return Loss) at  $V_{ctrl} = 1\text{ V}$  vs Frequency vs Temperature

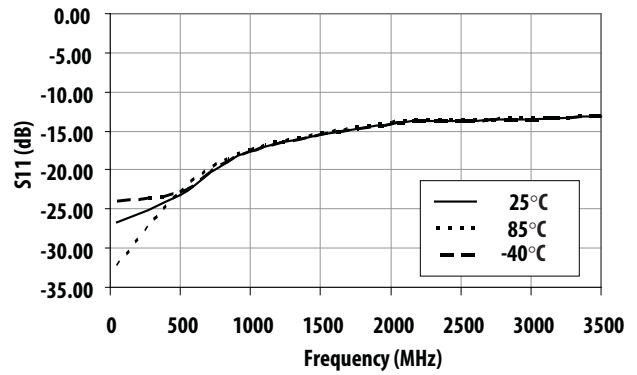

Figure 20. S11 (Return Loss) at  $V_{ctrl} = 5\text{ V}$  vs Frequency vs Temperature

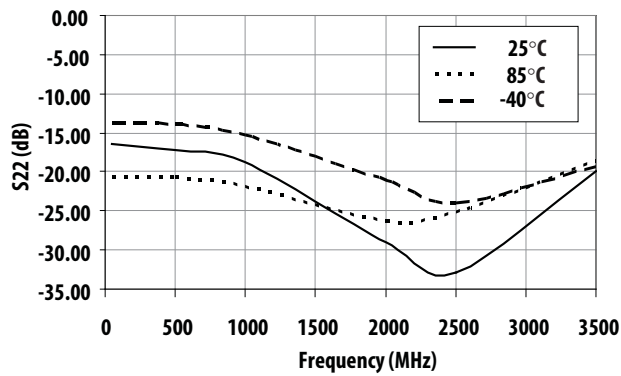

Figure 21. S22 (Return Loss) at  $V_{ctrl} = 1\text{ V}$  vs Frequency vs Temperature

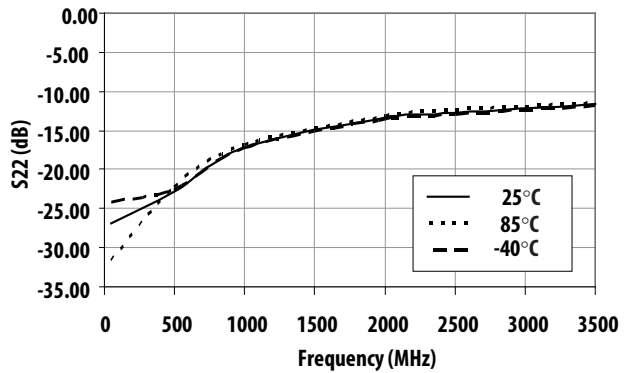

Figure 22. S22 (Return Loss) at  $V_{ctrl} = 5\text{ V}$  vs Frequency vs Temperature



## ALM-38140 Typical Over-Temperature With Phase Compensation Coil Performance

(Vsupply = 2.7 V, Vctrl = 1 V & 5 V)

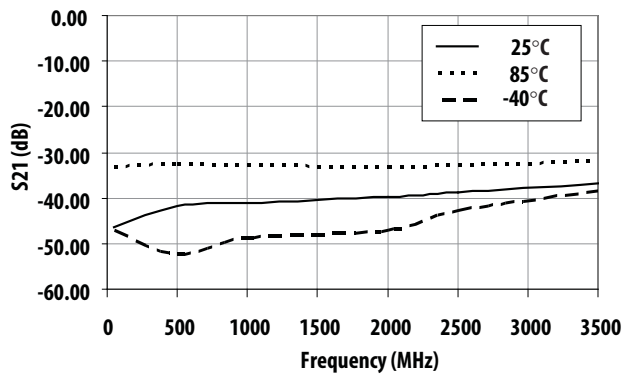

Figure 23. S21 at Vctrl=1V (Attenuation) vs Frequency vs Temperature

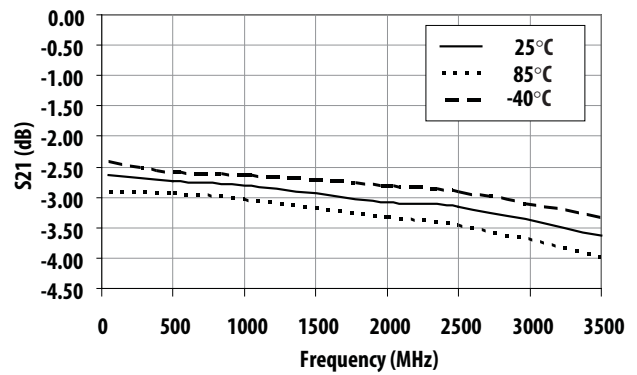

Figure 24. S21 at Vctrl=5V (Insertion Loss) vs Frequency vs Temperature

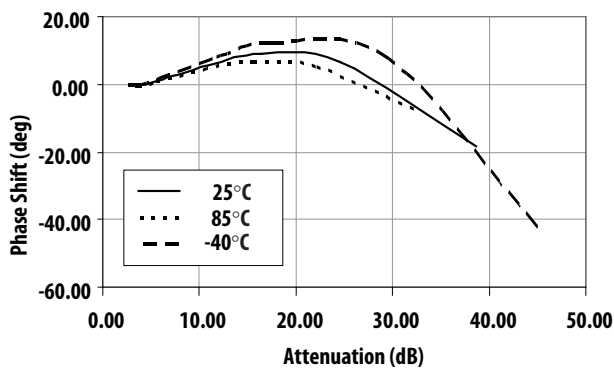

Figure 25. Phase shift vs Attenuation vs Temperature at 900MHz

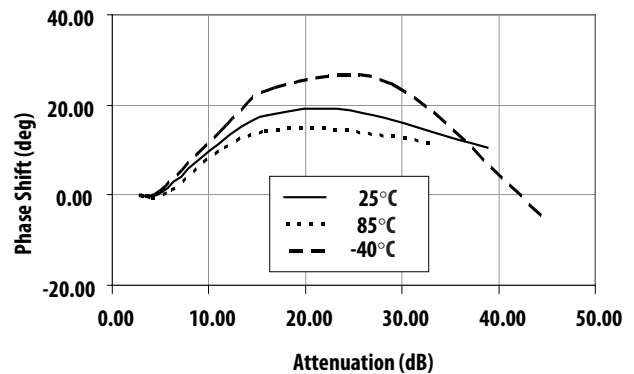

Figure 26. Phase shift vs Attenuation vs Temperature at 1900MHz

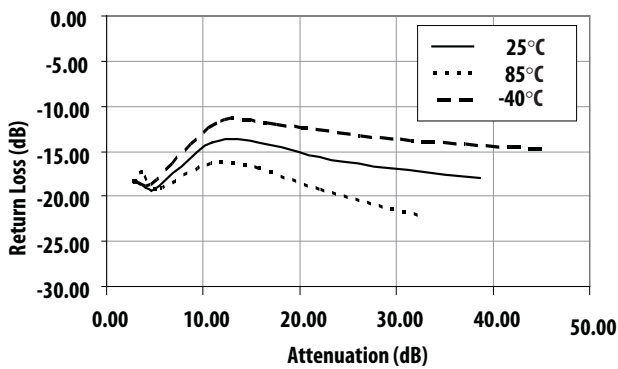

Figure 27. Return loss vs Attenuation vs Temperature at 900MHz

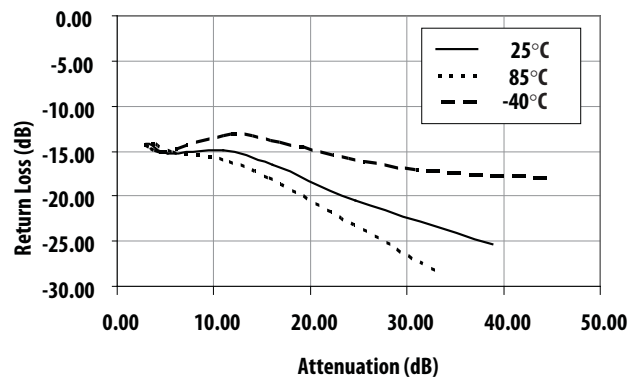

Figure 28. Return loss vs Attenuation vs Temperature at 1900MHz

## ALM-38140 Typical Over-Temperature With Phase Compensation Coil Performance

(Vsupply = 2.7 V, Vctrl = 1 V & 5 V)

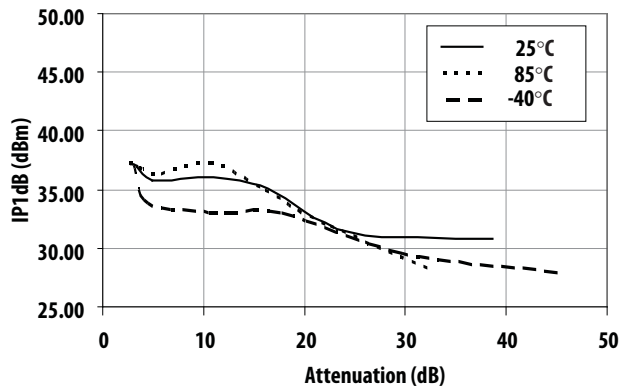

Figure 29. Input P1dB vs Attenuation vs Temperature at 900MHZ

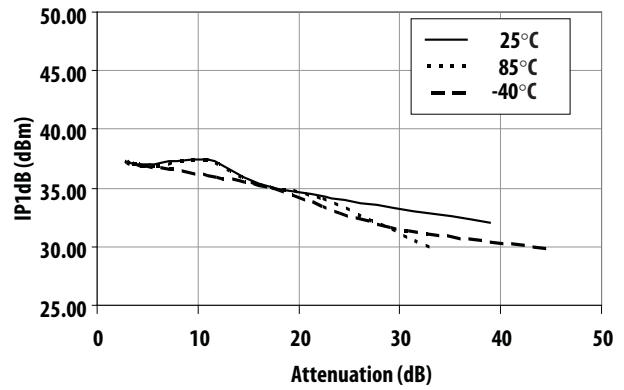

Figure 30. Input P1dB vs Attenuation vs Temperature at 1900MHZ

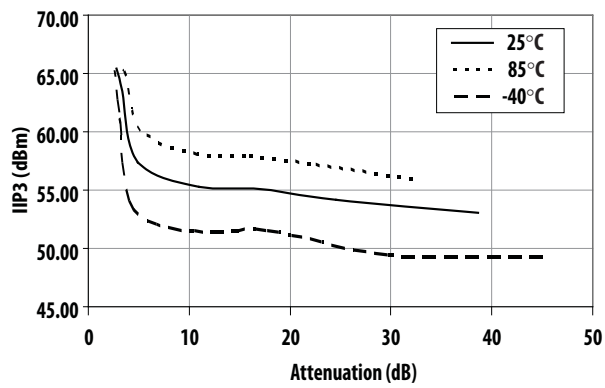

Figure 31. Input IP3 vs Attenuation vs Temperature at 900MHZ

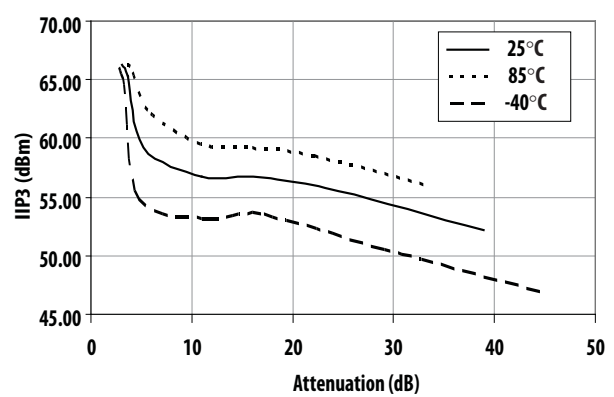

Figure 32. Input IP3 vs Attenuation vs Temperature at 1900MHZ

## Application Circuit

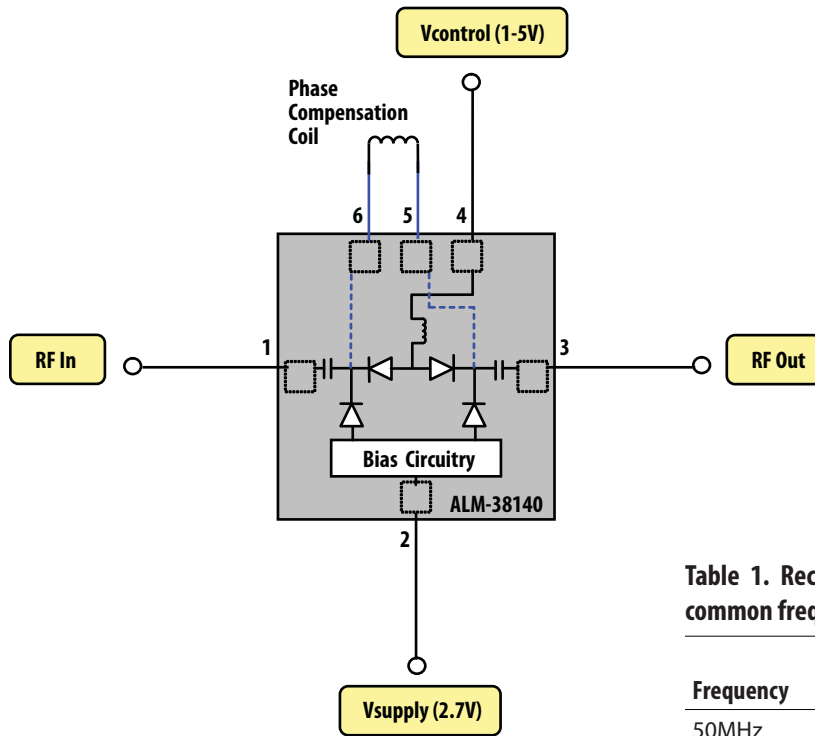

Figure 33. Simplified Schematic

The phase compensation coil connected at Pin 5 (Linput) and Pin 6 (Loutput) to further increase maximum attenuation and to improve phase shift.

Table 1. Recommended phase compensation coil values for common frequency bands

| Frequency | Ltune Value | Size | Manufacturer Part No.    |
|-----------|-------------|------|--------------------------|
| 50MHz     | 3.9uH       | 0805 | Coilcraft 0805LS-392XJLC |
| 500MHz    | 220nH       | 0603 | Toko LL2012-FR22K        |
| 1000MHz   | 180nH       | 0603 | Coilcraft 0603HP-R18XJLW |
| 2000MHz   | 62nH        | 0402 | Murata LQW15AN62NG00     |
| 2500MHz   | 36nH        | 0402 | Coilcraft 0402HP-36NXJLW |
| 3500MHz   | 22nH        | 0402 | Murata LQW15AN22NG00     |

## Demo board Layout

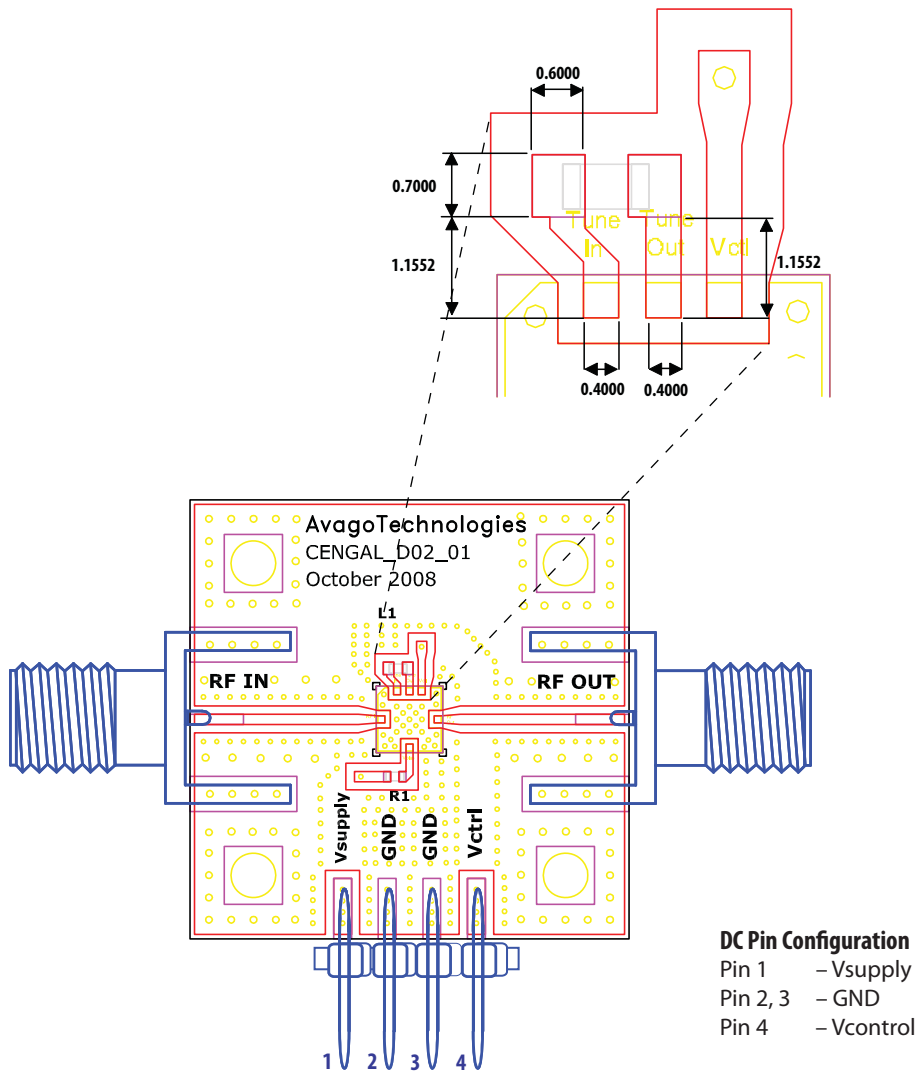

\* Dimensions in mm

**Figure 34. Demo board Layout**

Notes:

1. PCB material used is 10 mils Rogers RO4350, with FR4 backing for mechanical strength.
2. The phase compensation coil values given in Table 1 are based on the trace layout on demo board shown in Figure 33. Trace layout different from that specified in Figure 33, will require different values for the phase compensation coil.
3. Pad layout for phase compensation coil shown in Figure 33 is based on 0402 size.

## Package Dimension Drawing

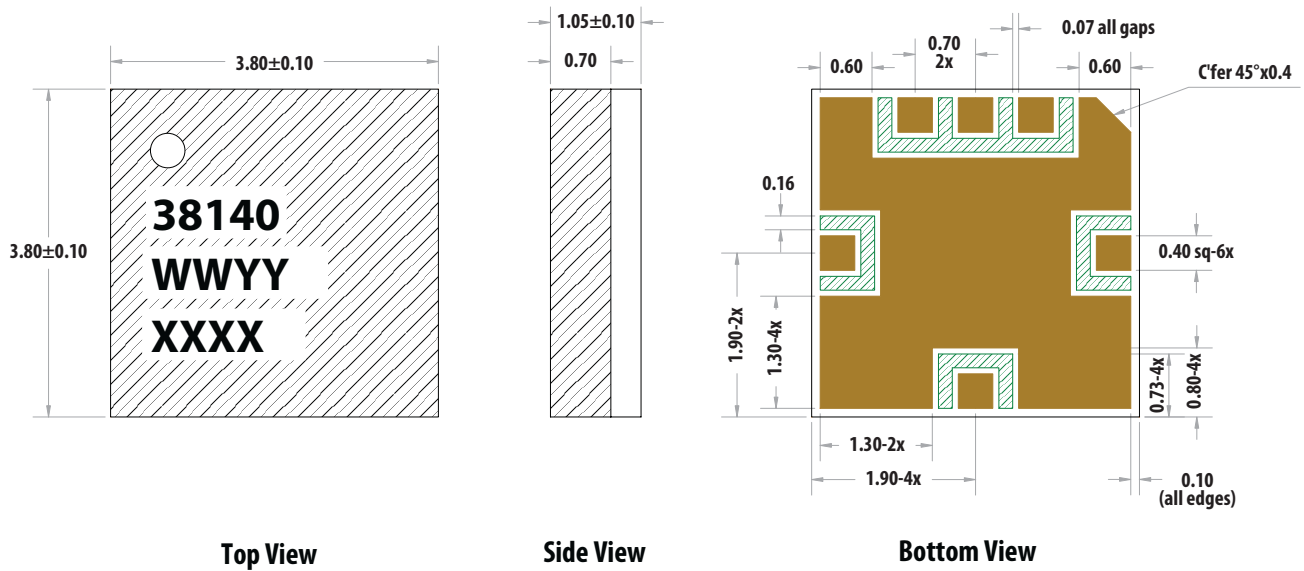

**Top View**

**Side View**

**Bottom View**

**Note :**

1. ALL DIMENSIONS ARE IN MILIMETERS
2. DIMENSIONS ARE INCLUSIVE OF PLATING
3. DIMENSIONS ARE EXCLUSIVE OF MOLD FLASH AND METAL BURR.
4. KEY: WW - WORK WEEK  
YY - YEAR,  
XXXX - LAST 4 DIGITS OF LOT NUMBER

## PC Board and stencil design (Top View)

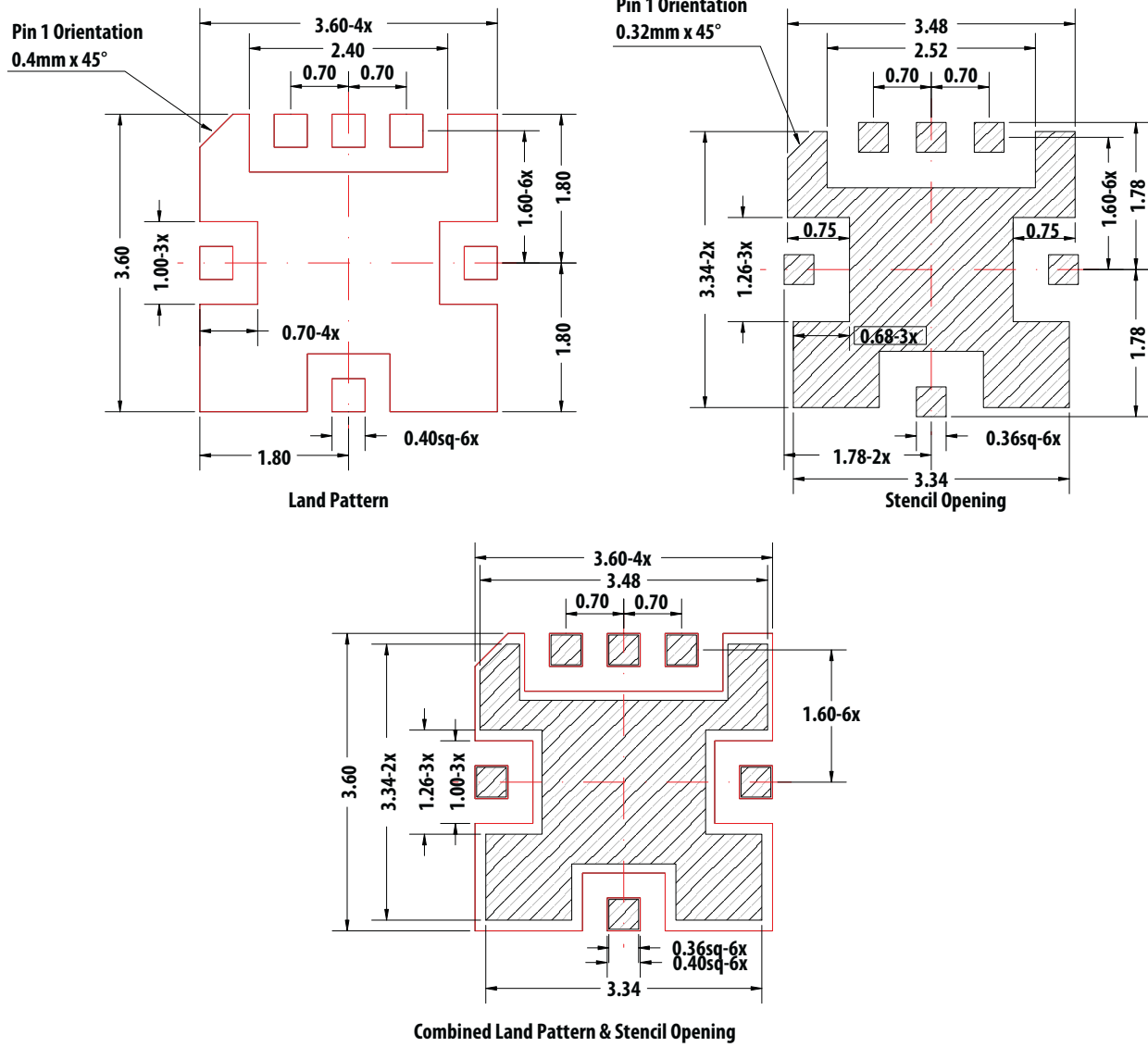

## Device Orientation

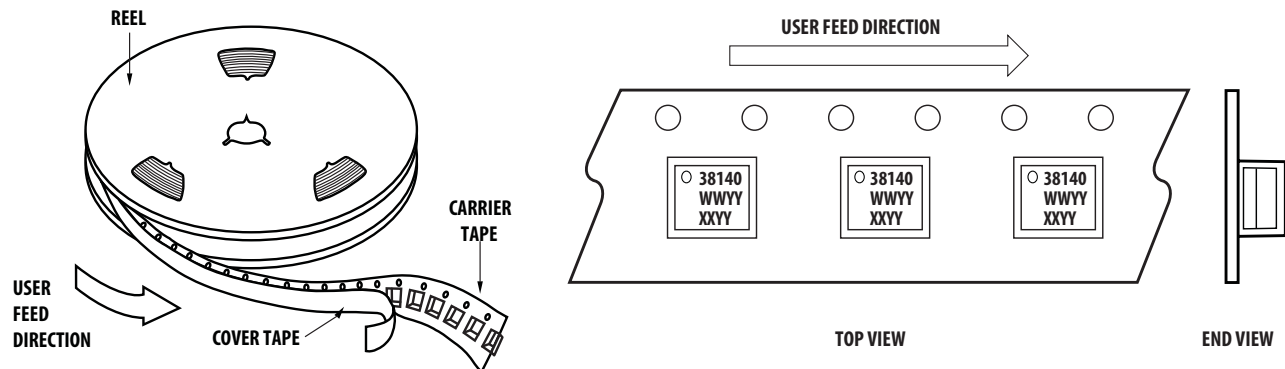

## Tape Dimensions

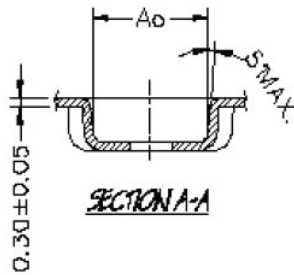
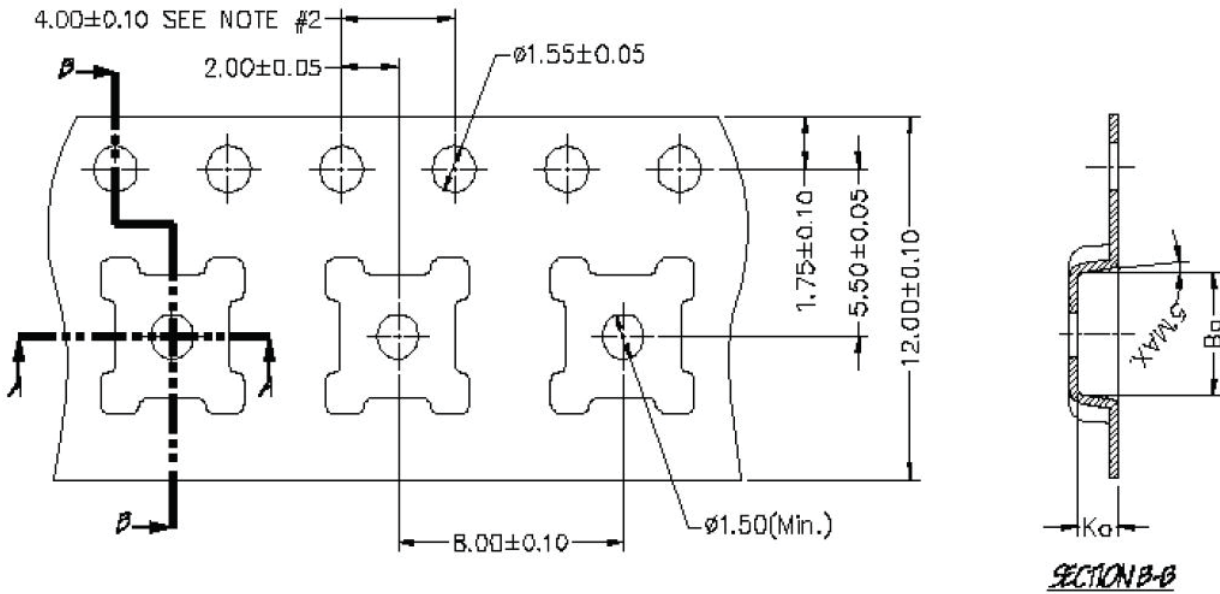

| Dimension List |           |
|----------------|-----------|
| Annote         | Milimeter |
| Ao             | 4.10      |
| Bo             | 4.10      |
| Ko             | 1.45      |
| Pitch          | 8.00      |
| Width          | 12.00     |

### Notes:

1. Ao & Bo measured at 0.3mm above base of pocket.
2. 10 pitches cumulative tol. ±0.2mm.

## Part Number Ordering Information

| Part Number    | No. of Devices | Container      |
|----------------|----------------|----------------|
| ALM-38140-BLKG | 100            | Antistatic Bag |
| ALM-38140-TR1G | 3000           | 13" Reel       |

# Reel Dimensions (13" reel)

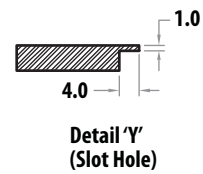
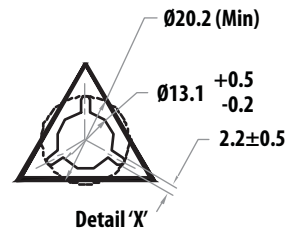
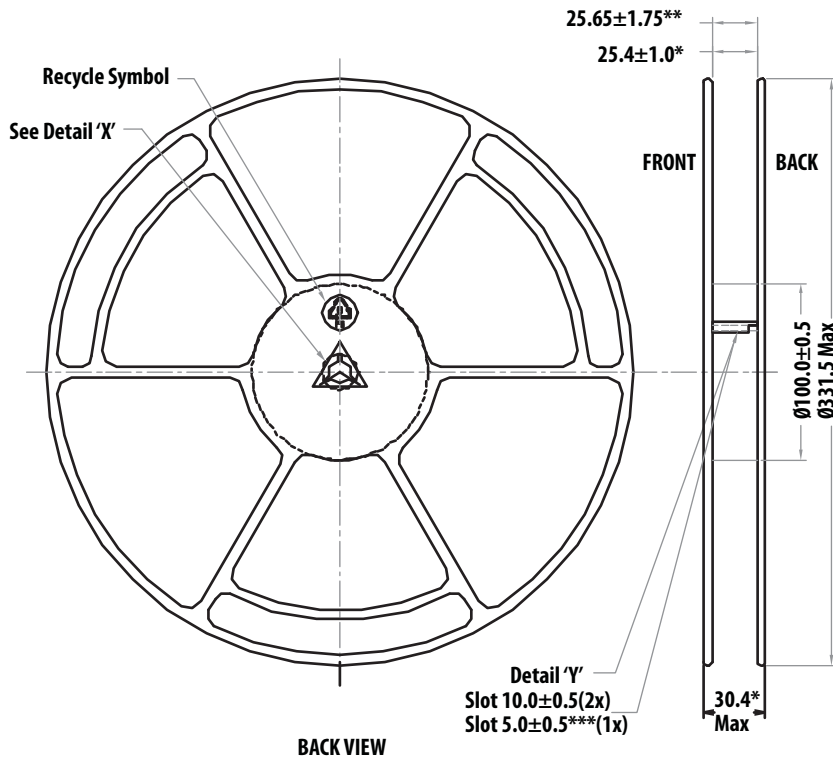
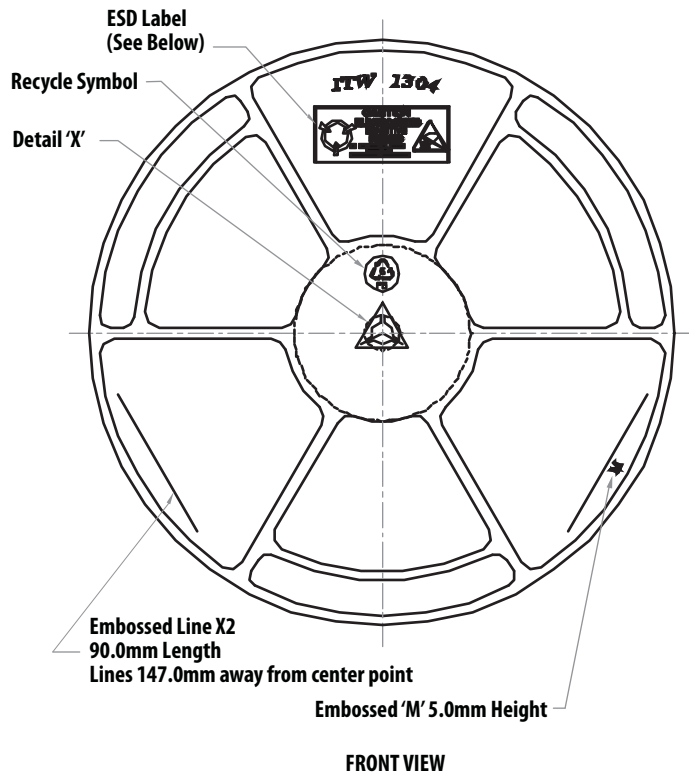

For product information and a complete list of distributors, please go to our web site: [www.avagotech.com](http://www.avagotech.com)

Avago, Avago Technologies, and the A logo are trademarks of Avago Technologies in the United States and other countries. Data subject to change. Copyright © 2005-2010 Avago Technologies. All rights reserved. AV02-1987EN - April 8, 2010

