

PK7522

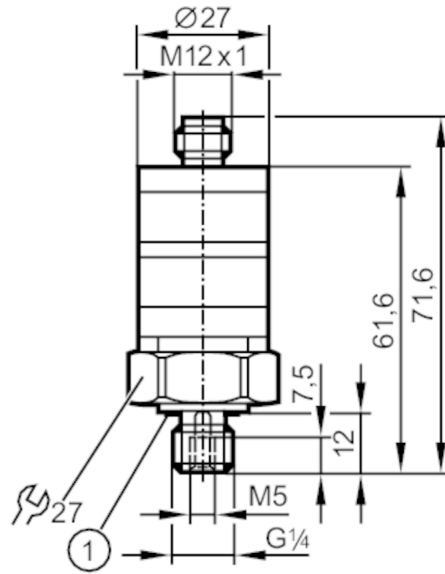

Pressure switch with intuitive switch point setting

PK-100-SFG14-QSPKG/US/ IW



1 Sealing



Product characteristics

Output signal	switching signal	
Measuring range	0...100 bar	0...1450 psi
Process connection	threaded connection G 1/4 external thread internal thread M5	

Application

Application	for industrial applications	
Media	liquids and gases	
Medium temperature [°C]	-25...80	
Pressure rating	200 bar	2900 psi
Min. bursting pressure	1000 bar	14500 psi
Type of pressure	relative pressure	

Electrical data

Operating voltage [V]	9.6...32 DC	
Current consumption [mA]	< 25	
Min. insulation resistance [MΩ]	100; (500 V DC)	
Protection class	III	
Reverse polarity protection	yes	

Inputs / outputs

Number of inputs and outputs	Number of digital outputs: 2
------------------------------	------------------------------



Pressure switch with intuitive switch point setting

PK-100-SFG14-QSPKG/US/ IW

Outputs		
Total number of outputs	2	
Output signal	switching signal	
Electrical design	PNP	
Number of digital outputs	2	
Output function	normally open	
Max. voltage drop switching output DC [V]	2	
Permanent current rating of switching output DC [mA]	500	
Switching frequency DC [Hz]	100	
Short-circuit protection	yes	
Type of short-circuit protection	pulsed	
Overload protection	yes	
Measuring/setting range		
Measuring range	0...100 bar	0...1450 psi
Set point SP	3...100 bar	45...1450 psi
Hysteresis	2 bar	29 psi
Accuracy / deviations		
Switch point accuracy [% of the final value]	< ± 2,5; (Setting accuracy)	
Repeatability [% of the final value]	< ± 0,5; (with temperature fluctuations < 10 K)	
Characteristics deviation [% of the final value]	< ± 1,5 (BFSL) / < ± 2,5 (LS); (BFSL = Best Fit Straight Line; LS = limit value setting)	
Temperature drift per 10 K	< ± 0.5	
Software / programming		
Adjustment of the switch point	setting rings	
Operating conditions		
Ambient temperature [°C]	-25...80	
Storage temperature [°C]	-40...100	
Protection	IP 67	
Tests / approvals		
EMC	DIN EN 61000-6-2	
	DIN EN 61000-6-3	
Shock resistance	DIN IEC 68-2-27	50 g (11 ms)
Vibration resistance	DIN IEC 68-2-6	20 g (10...2000 Hz)
MTTF [years]	513	
Pressure Equipment Directive	Sound engineering practice; can be used for group 2 fluids; group 1 fluids on request	

PK7522



Pressure switch with intuitive switch point setting

PK-100-SFG14-QSPKG/US/ IW

Mechanical data	
Weight [g]	94.5
Materials	PBT; PC; FKM; stainless steel (1.4404 / 316L)
Materials (wetted parts)	stainless steel (1.4404 / 316L); FKM
Min. pressure cycles	50 million
Tightening torque [Nm]	25
Process connection	threaded connection G 1/4 external thread internal thread M5
Restrictor element integrated	no (can be retrofitted)

Displays / operating elements	
Display	switching status 2 x LED, yellow
With scale	yes

Remarks	
Pack quantity	1 pcs.

Electrical connection

Connector: 1 x M12



Connection

