

## MAX17760AEVKIT# Evaluation Kit

## Evaluates: MAX17760 in 5V Output-Voltage Application

### General Description

The MAX17760AEVKIT# evaluation kit (EV kit) provides a proven design to evaluate the MAX17760 high-efficiency, high-voltage, synchronous step-down DC-DC converter in a TDFN package. The EV kit generates 5V at load currents up to 300mA from a 7V to 76V input supply. The EV kit features a 400kHz switching frequency for optimum efficiency and component size. The EV kit features adjustable input undervoltage lockout, adjustable soft-start, adjustable switching frequency, open-drain  $\overline{\text{RESET}}$  signal, and external clock synchronization. The EV kit also provides a good layout example, which is optimized for conducted, radiated EMI, and thermal performance. For more details about the IC benefits and features, refer to the *MAX17760 IC data sheet*.

### Features

- Operates from a 7V to 76V Input Supply
- 5V Output Voltage
- Up to 300mA Output Current
- 400kHz Switching Frequency
- Enable/UVLO Input, Resistor-Programmable UVLO Threshold
- Adjustable Soft-Start Time
- MODE Pin to Select between PWM or PFM Modes
- Bootstrap Bias Input for Improved Efficiency
- Open-Drain  $\overline{\text{RESET}}$  Output
- External Clock Synchronization
- Overcurrent and Overtemperature Protection
- Proven PCB Layout
- Fully Assembled and Tested
- Complies with CISPR22 (EN55022) Class B Conducted and Radiated Emissions

**Ordering Information** appears at end of data sheet.

### Quick Start

#### Recommended Equipment

- MAX17760 5V output EV kit
- 76V, 0.5A DC input power supply
- Load capable of sinking 300mA
- 2 digital voltmeters (DVM)

#### Equipment Setup and Test Procedure

The EV kit is fully assembled and tested. Follow the steps below to verify board operation.

**Caution: Do not turn on power supply until all connections are completed.**

- 1) Set the power supply at a voltage of 5.5V. Then, disable the power supply.
- 2) Connect the positive terminal of the power supply to the VIN PCB pad and the negative terminal to the nearest PGND PCB pad. Connect the positive terminal of the 300mA load to the VOUT PCB pad and the negative terminal to the nearest PGND PCB pad.
- 3) Connect one DVM across the VOUT PCB pad and the nearest PGND PCB pad, and the other DVM across  $\overline{\text{RESET}}$  PCB pad and SGND PCB pad.
- 4) Verify that shunts are installed across pins 1–2 on jumper JU1 and JU2 (see [Table 1](#) and [Table 2](#) for details), and on pin 1 of JU3.
- 5) Turn on the DC power supply.
- 6) Enable the load.
- 7) Verify that both the DVMs displays approximately 0V.
- 8) Increase the input voltage to 7V, which is just above the EN/UVLO rising threshold.
- 9) Verify that the DVM across the VOUT PCB pad and the nearest PGND PCB pad displays 5V.
- 10) Verify that the DVM across the  $\overline{\text{RESET}}$  PCB pad and the SGND PCB pad displays 5V.
- 11) The power-supply voltage can be set at any voltage between 7V and 76V and both the DVMs still read the same voltages.
- 12) Reduce the input voltage to 5V, which is below the EN/UVLO falling threshold.
- 13) Verify that both the DVMs displays approximately 0V.
- 14) Disable the input power supply.

### Detailed Description

The MAX17760AEVKIT# provides a proven design to evaluate the MAX17760 high-efficiency, high-voltage, synchronous step-down DC-DC converter. The EV kit generates 5V at load currents up to 300mA from a 7V to 76V input supply. The EV kit features a 400kHz switching frequency for optimum efficiency and component size. The EV kit includes an EN/UVLO PCB pad and JU1 to enable the output at a desired input voltage or enable the converter through an external enable signal on the EN/UVLO PCB pad. The RT/SYNC PCB pad and JU3 allow an external clock to synchronize the device. An additional RESET PCB pad is available for monitoring when the converter output is in regulation.

### Enable/Undervoltage-Lockout (EN/UVLO) Programming

The MAX17760 offers an Enable and an adjustable input undervoltage lockout feature. In this EV kit, for always-on operation, leave the EN/UVLO jumper (JU1) open. To disable the MAX17760, install a shunt across pins 2–3 on JU1. See [Table 1](#) for JU1 settings. The EN/UVLO PCB pad on the EV kit supports external Enable/Disable control of the device. Leave JU1 open when external Enable/Disable control is desired. A potential divider formed by R1 and R2 sets the input voltage ( $V_{INU}$ ) above which the converter is enabled when a shunt is connected across pins 1–2 on JU1.

Choose R1 as follows:

$$R1 \leq (110000 \times V_{INU})$$

**Table 1. Converter EN/UVLO Jumper (JU1) Settings**

JUMPER	SHUNT POSITION	EN/UVLO PIN	MAX17760 OUTPUT
JU1	1-2*	Connected to the center node of resistor-divider R1 and R2	Enabled, UVLO level set through the R1 and R2 resistors
	Not installed	Floating	Always ON
	2-3	Connected to SGND	Disabled

\*Default Position

where,  $V_{INU}$  is the voltage at which the device is required to turn on, and R1 is in  $\Omega$ . Calculate the value of R2 as follows:

$$R2 = \frac{1.215 \times R1}{(V_{INU} - 1.215 + (2.5\mu A \times R1))}$$

### Soft-Start Input (SS)

The EV kit offers an adjustable soft-start function to limit inrush current during startup. The soft-start time is adjusted by the value of external soft-start capacitor ( $C_6$ ) connected between SS and SGND. The selected output capacitance ( $C_{SEL}$ ) and the output voltage ( $V_{OUT}$ ) determine the minimum required soft-start capacitor as follows:

$$C_{SS} \geq 30 \times 10^{-6} \times C_{SEL} \times V_{OUT}$$

The soft-start time ( $t_{SS}$ ) is related to the capacitor connected at SS ( $C_{SS}$ ) by the following equation:

$$t_{SS} = \frac{C_{SS}}{6.25 \times 10^{-6}}$$

For example, to program a 0.9ms soft-start time, a 5.6nF capacitor should be connected from the SS pin to SGND.

### Mode of Operation Selection (MODE)

The EV kit provides a jumper (JU2) that allows the MAX17760 to operate either in PWM or PFM modes. [Table 2](#) shows the mode selection (JU2) settings that can be used to configure the desired mode of operation. Refer to the *MAX17760 IC data sheet* for more details on the modes of operation.

The mode of operation cannot be changed on-the-fly after power-up.

**Table 2. Modes Selection Jumper (JU2) Settings**

SHUNT POSITION	MODE PIN	MODE OF OPERATION
1-2*	Connected to SGND	PWM
Not Installed	Unconnected	PFM

\*Default Setting

**External Clock Synchronization (RT/SYNC)**

The EV kit provides an RT/SYNC PCB pad, to synchronize the MAX17760 to an optional external clock. Short jumper (JU3) when external clock signals are applied. See [Table 3](#) for JU3 settings. In the presence of a valid external clock for synchronization, the MAX17760 operates in PWM mode only. For more details about external clock synchronization, refer to the *MAX17760 IC data sheet*.

**Active-Low, Open-Drain Reset Output ( $\overline{\text{RESET}}$ )**

The EV kit provides a  $\overline{\text{RESET}}$  PCB pad to monitor the status of the converter.  $\overline{\text{RESET}}$  goes high when  $V_{\text{OUT}}$  rises above 95% (typ) of its nominal regulated output voltage.  $\overline{\text{RESET}}$  goes low when  $V_{\text{OUT}}$  falls below 92% (typ) of its nominal regulated voltage.

**Hot Plug-In and Long Input Cables**

The MAX17760AEVKIT# EV kit PCB layout provides an optional electrolytic capacitor ( $C1 = 22\mu\text{F}/100\text{V}$ ). This capacitor limits the peak voltage at the input of the MAX17760 when the DC input source is “Hot-Plugged” to the EV kit input terminals with long input cables. The equivalent series resistance (ESR) of the electrolytic capacitor dampens the oscillations caused by interaction of the inductance of the long input cables, and the ceramic capacitors at the buck converter input.

**Table 3. External Clock Synchronization Jumper (JU3) Settings**

SHUNT POSITION	RT/SYNC PIN
1-2	Connected to RT/SYNC PCB pad through a 22pF capacitor.
Not Installed*	Not connected to RT/SYNC PCB pad

\*Default Position

**Electromagnetic Interference (EMI)**

Compliance to conducted emissions (CE) standards requires an EMI filter at the input of a switching power converter. The EMI filter attenuates high-frequency currents drawn by the switching power converter and limits the noise injected back into the input power source.

The MAX17760AEVKIT# EV kit PCB has designated footprints on the bottom side for placement of EMI filter components. Use of these filter components results in lower conducted emissions below CISPR22 Class B limits. Cut open the trace at L2 before installing conducted EMI filter components. The MAX17760AEVKIT# EV kit PCB layout is also designed to limit radiated emissions from switching nodes of the power converter, resulting in radiated emissions below CISPR22 Class B limits.

MAX17760AEVKIT# Performance Report

( $V_{IN} = 24V$ ,  $V_{OUT} = 5V$ ,  $f_{SW} = 400kHz$ ,  $T_A = +25^{\circ}C$ , unless otherwise noted.)

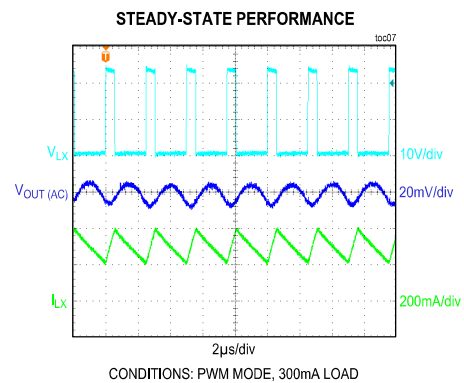
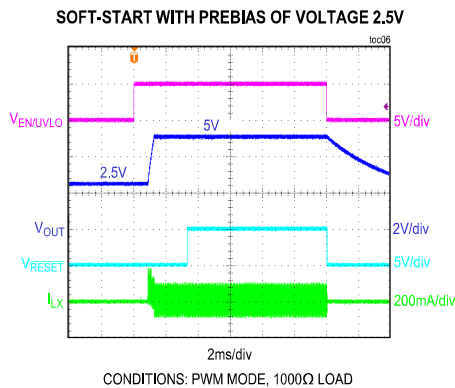
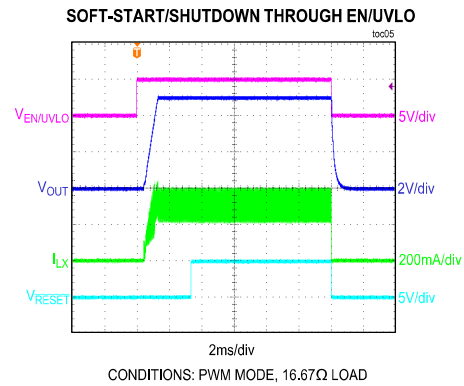
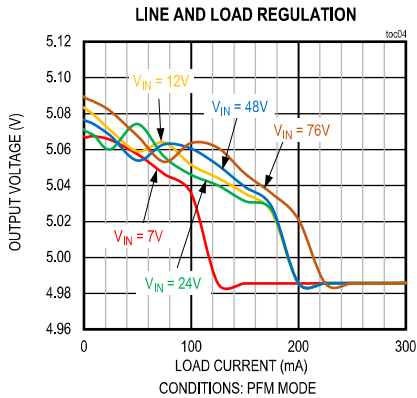
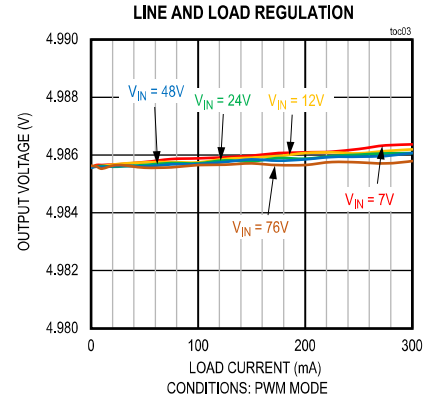
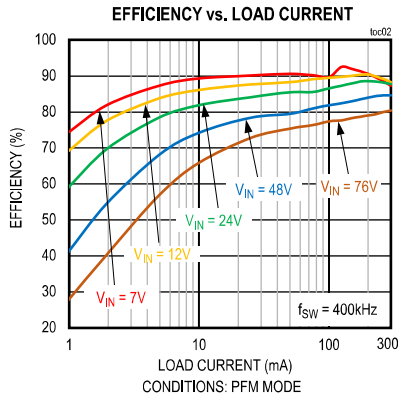
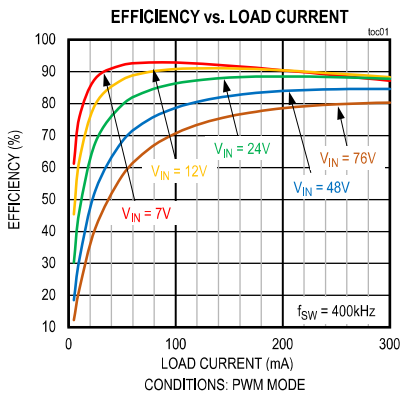

**MAX17760AEVKIT# Performance Report (continued)**

( $V_{IN} = 24V$ ,  $V_{OUT} = 5V$ ,  $f_{SW} = 400kHz$ ,  $T_A = +25^{\circ}C$ , unless otherwise noted.)

**STEADY-STATE PERFORMANCE**

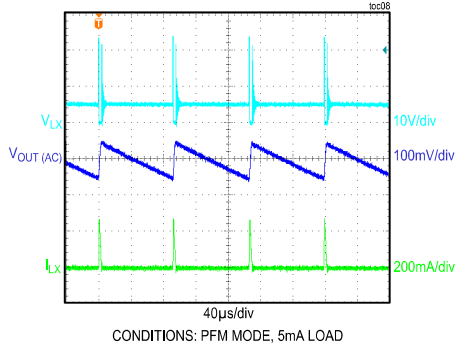

**LOAD TRANSIENT BETWEEN 0mA AND 150mA**

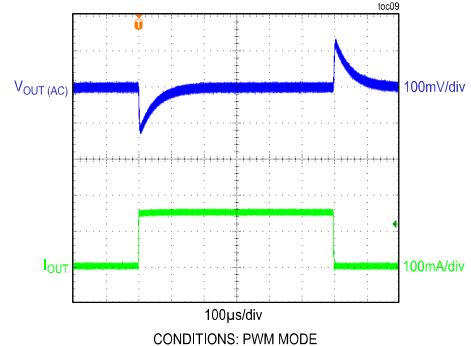

**LOAD TRANSIENT BETWEEN 150mA AND 300mA**

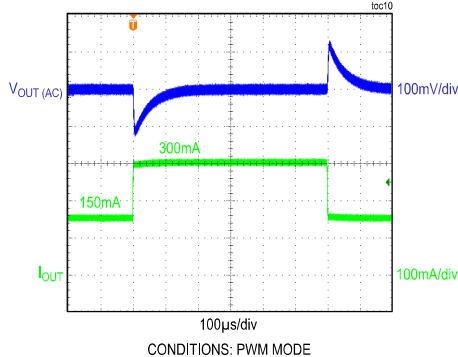

**LOAD TRANSIENT BETWEEN 5mA AND 150mA**

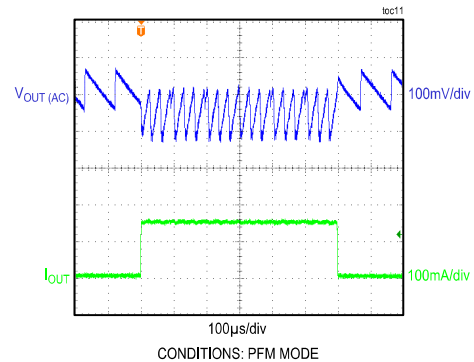

**BODE PLOT**

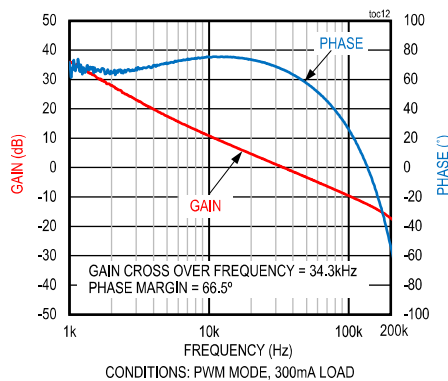

**CONDUCTED EMISSIONS PLOT  
5V OUTPUT, 300mA LOAD CURRENT**

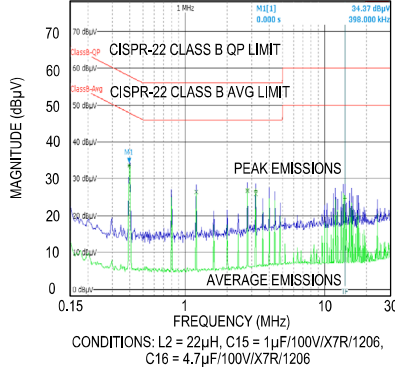

**RADIATED EMISSIONS PLOT  
5V OUTPUT, 300mA LOAD CURRENT**

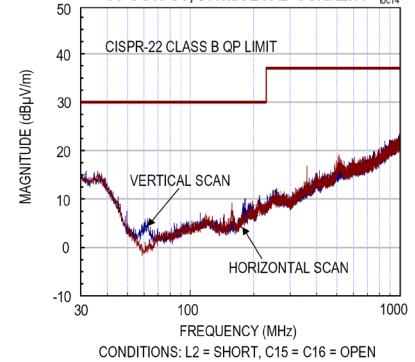

## MAX17760AEVKIT# Evaluation Kit

Evaluates: MAX17760 in  
5V Output-Voltage Application

### Component Suppliers

SUPPLIER	WEBSITE
Murata Americas	www.murata.com
Panasonic Corp.	www.panasonic.com
TDK Corp.	www.tdk.com
SULLINS	www.sullinscorp.com
Würth Electronics	www.we-online.com
Coilcraft	www.coilcraft.com
Taiyo Yuden	www.ty-top.com
Yageo	www.yageo.com

**Note:** Indicate that you are using the MAX17760 when contacting these component suppliers.

### Ordering Information

PART	TYPE
MAX17760AEVKIT#	EV Kit

#Denotes RoHS compliant.

## MAX17760AEVKIT# EV Kit Bill of Materials

S. No.	DESIGNATOR	DESCRIPTION	QUANTITY	PART NUMBER
1	C1	22 $\mu$ F, 20%, 100V, Electrolytic capacitor	1	PANASONIC EEE-TG2A220UP
2	C2	1 $\mu$ F, 10%, 100V, X7R, Ceramic capacitor (1206)	1	TDK C3216X7R2A105K160AA
3	C3,C14	0.1 $\mu$ F, 10%, 100V, X7R, Ceramic capacitor (0603)	2	YAGEO CC0603KRX7R0BB104
4	C4, C13	220pF, 10%, 100V, C0G, Ceramic capacitor (0603)	2	KEMET C0603C221K1GAC
5	C5	22pF, 5%, 50V, C0G, Ceramic capacitor (0402)	1	MURATA GCM1555C1H220JA16
6	C6	5600pF, 10%, 25V, X7R, Ceramic capacitor (0402)	1	MURATA GRM155R71E562KA01
7	C7	0.1 $\mu$ F, 10%, 50V, X7R, Ceramic capacitor (0402)	1	TDK C1005X7R1H104K050BE
8	C8	1 $\mu$ F, 10%, 6.3V, X7R, Ceramic capacitor (0603)	1	MURATA GRM188R70J105KA01
9	C9	10 $\mu$ F, 10%, 16V, X7R, Ceramic capacitor (0805)	1	MURATA GRM21BZ71C106KE15
10	C11	0.1 $\mu$ F, 10%, 16V, X7R, Ceramic capacitor (0402)	1	TAIYO YUDEN EMK105B7104KV-F
11	JU1	3-pin header	1	SULLINS PEC03SAAN
12	JU2, JU3	2-pin header	2	SULLINS PEC02SAAN
13	L1	INDUCTOR, 56 $\mu$ H, 0.7A	1	WURTH 74408943560
14	R1	649k $\Omega$ $\pm$ 1%, 1/10W, resistor (0603)	1	Any
15	R2	127k $\Omega$ $\pm$ 1%, 1/10W, resistor (0603)	1	Any
16	R3	95.3k $\Omega$ $\pm$ 1%, 1/16W, resistor (0402)	1	Any
17	R4	18.2k $\Omega$ $\pm$ 1%, 1/16W, resistor (0402)	1	Any
18	R5	69.8k $\Omega$ , $\pm$ 1%, 1/16W, resistor (0402)	1	Any
19	R6	10k $\Omega$ $\pm$ 5%, 1/10W, resistor (0402)	1	Any
20	R7	22 $\Omega$ , $\pm$ 5%, 1/16W, resistor (0402)	1	Any
21		Shunts	3	SULLINS STC02SYAN
22	U1	Buck Converter, MAX17760 (TDFN12-EP 3X3)	1	MAXIM MAX17760ATC+
23	MH1-MH4	MACHINE FABRICATED; ROUND-THRU HOLE SPACER; NO THREAD; M3.5; 5/8IN; NYLON	4	KEYSTONE 9032
24	C15	OPTIONAL: 1 $\mu$ F, 10%, 100V, X7R, Ceramic capacitor (1206)	1	TAIYO YUDEN HMK316B7105KLH-T
25	C16	OPTIONAL: 4.7 $\mu$ F, 10%, 100V, X7R, Ceramic capacitor (1206)	1	MURATA GRM31CZ72A475KE11
26	L2	OPTIONAL: INDUCTOR, 22 $\mu$ H, 0.28A (2mm x 2mm)	1	COILCRAFT XPL2010-223ML
27	C10	OPEN: Capacitor (0805)	0	
28	C12	OPEN: Capacitor (0402)	0	

## DEFAULT JUMPER TABLE

JUMPER	SHUNT POSITION
JU1	1-2
JU2	1-2
JU3	1





**MAX17760AEVKIT# EV Kit PCB Layout**

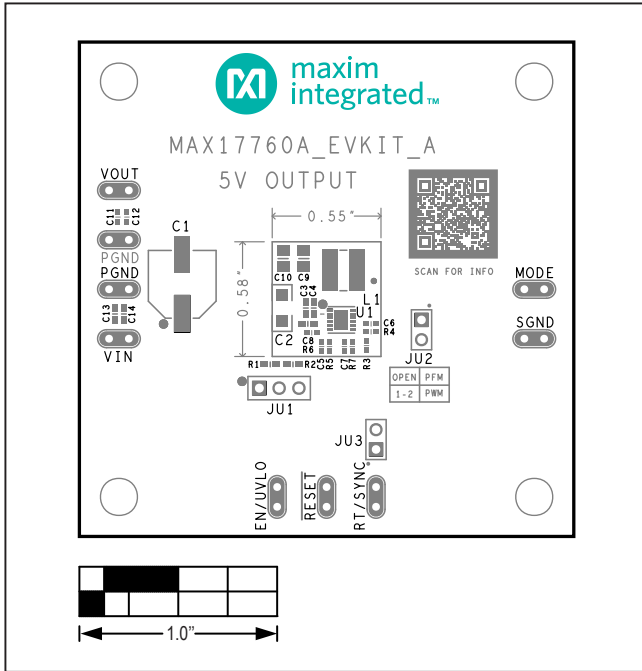

MAX17760AEVKIT# EV Kit—Top Silkscreen

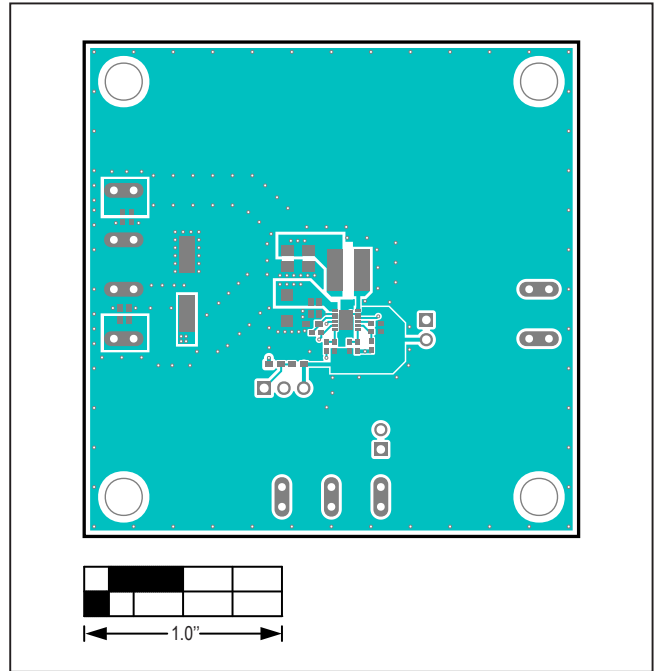

MAX17760AEVKIT# EV Kit—Top Layer

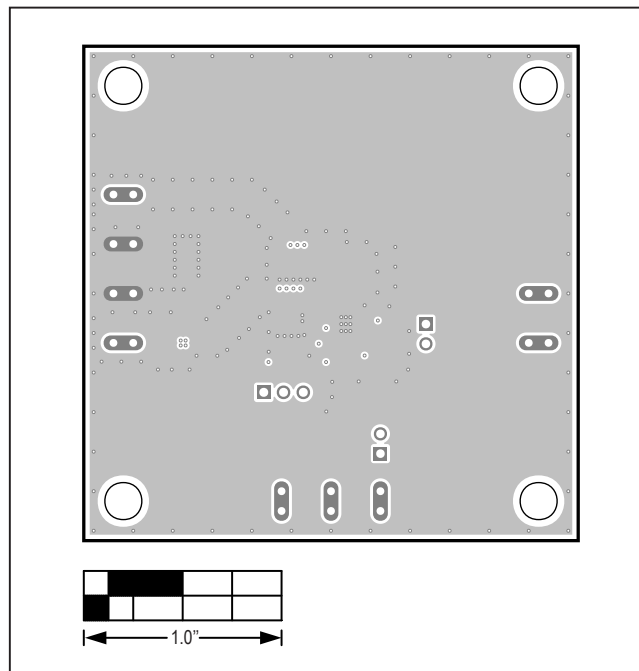

MAX17760AEVKIT# EV Kit—Layer 2

MAX17760AEVKIT# EV Kit PCB Layout (continued)

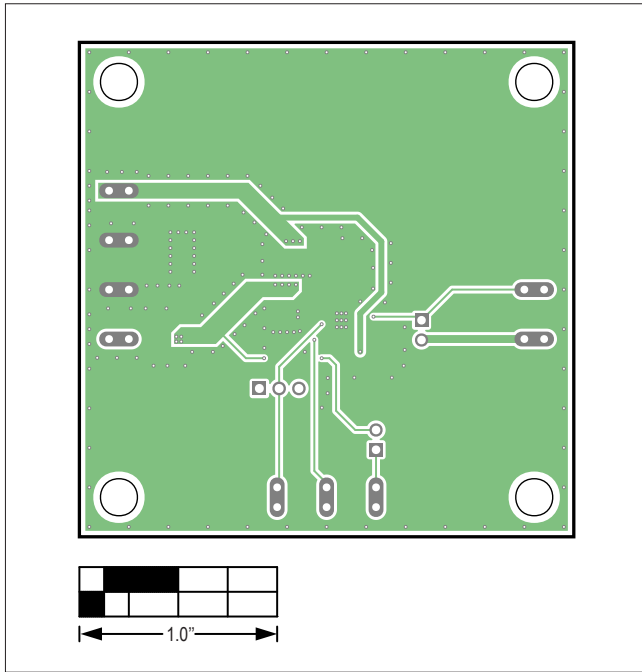

MAX17760AEVKIT# EV Kit—Layer 3

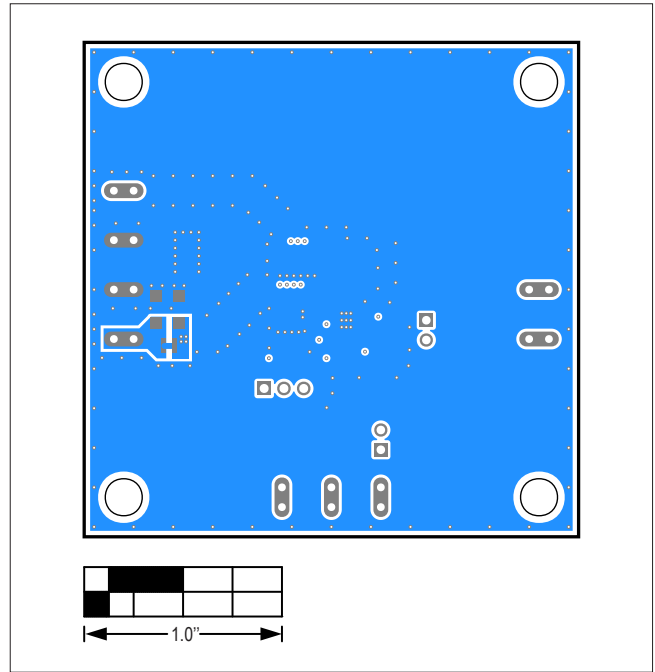

MAX17760AEVKIT# EV Kit—Bottom Layer

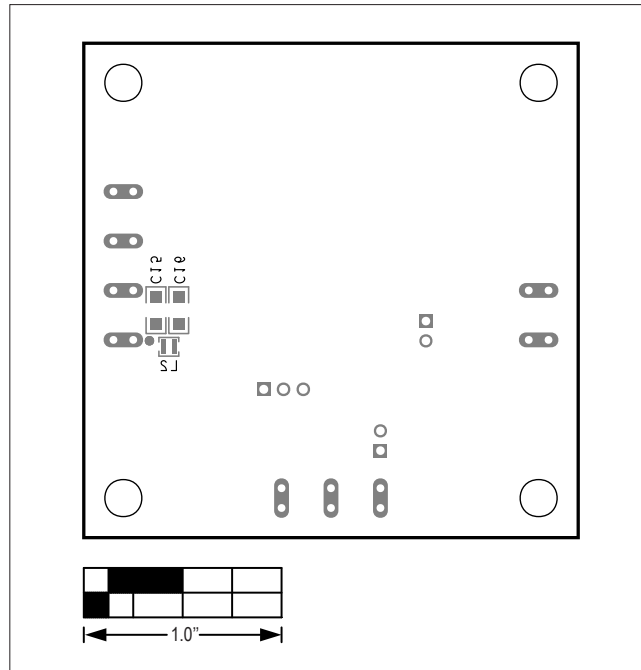

MAX17760AEVKIT# EV Kit—Bottom Silkscreen

### Revision History

REVISION NUMBER	REVISION DATE	DESCRIPTION	PAGES CHANGED
0	4/20	Initial release	—

For pricing, delivery, and ordering information, please visit Maxim Integrated's online storefront at <https://www.maximintegrated.com/en/storefront/storefront.html>.

*Maxim Integrated cannot assume responsibility for use of any circuitry other than circuitry entirely embodied in a Maxim Integrated product. No circuit patent licenses are implied. Maxim Integrated reserves the right to change the circuitry and specifications without notice at any time.*