

Factory Installed Panel Mount

BOURNS®

TRIMPOT® POTENTIOMETER PANEL MOUNTING OPTIONS AND HARDWARE

Many Trimpot® Potentiometers are available for panel mount application.

This product option provides for maximum design flexibility.

To order Trimpot® Potentiometers with panel mount hardware attached by the factory, simply add an "M" or "Z" suffix to the Bourns part number per Table I.

Example:
3006P-1-100Z

To order military Trimpot® Potentiometers with panel mount hardware attached by the factory, order the military part number and add "with panel mount attached."

Example:
RT12C2PRC, with panel mount attached.

To order panel mounting accessories for customer installation, simply use the part number per Table II.

Example:
H83P

NOTE: For complete product specifications, see data sheet for the trimmer model.

Torque - Apply maximum 8 in. lbs. on mounting nut when mounted on panel.

Models RT12/RJ12, 3057/3059

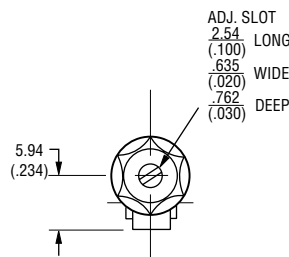
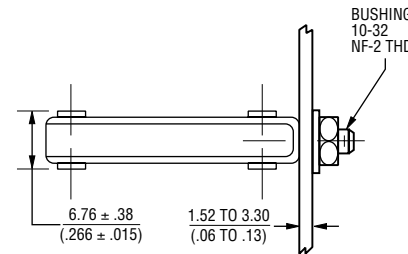
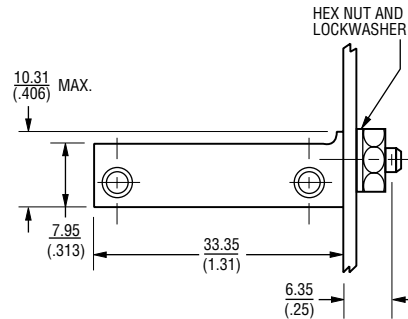

NOTES:

1. PROVIDED WITH LOCKWASHER AND MOUNTING NUT.
2. RECOMMEND PANEL HOLES. #10 DRILL $\frac{.194}{(.008)}$

Models 3005/3006/3009

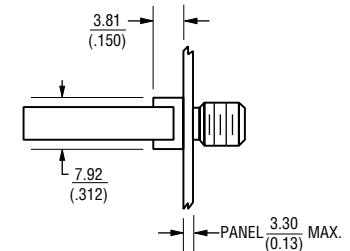
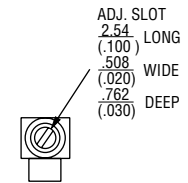
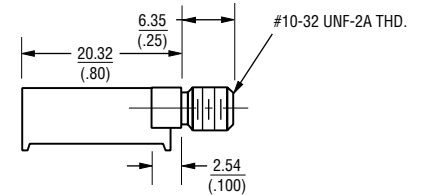

NOTES:

1. PROVIDED WITH LOCKWASHER AND MOUNTING NUT.
2. RECOMMEND PANEL HOLE SIZE #7 DRILL $\frac{.200}{(.008)}$

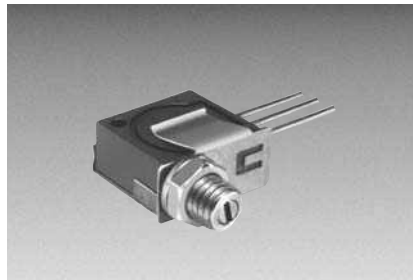

Factory Installed Panel Mount BOURNS®

Models 3292

Models RT22/RTR22/RJ22 3250/3252

Models RT24/RTR24/3290

X, L and W Styles

H and W Styles - 3290 X & W Styles-RT24/RTR24

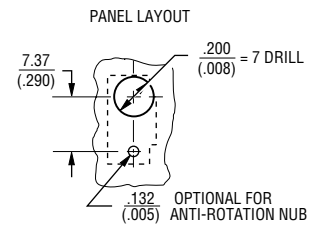
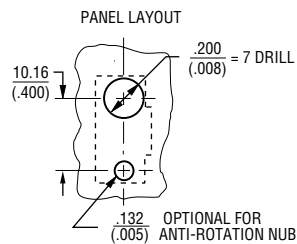
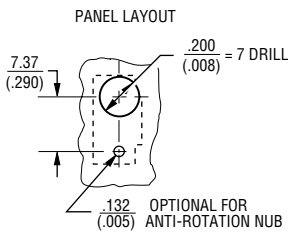
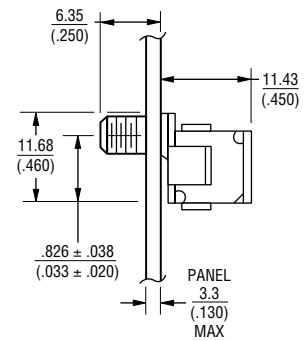
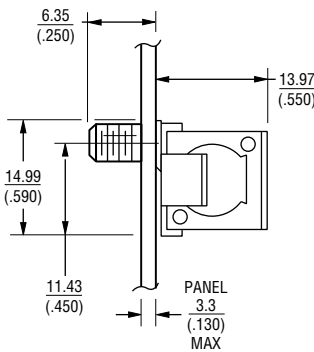
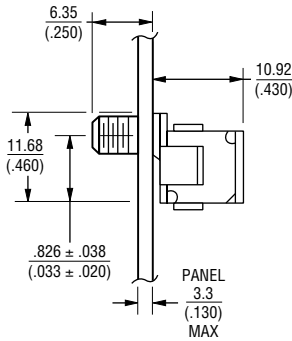
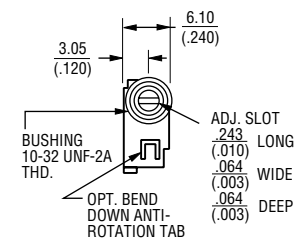
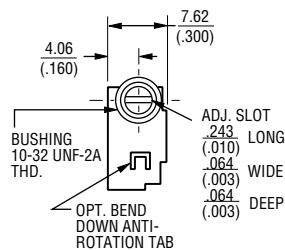
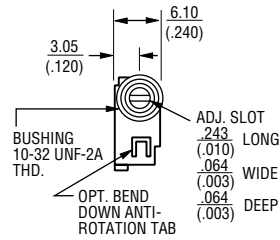

NOTES:
1. PROVIDED WITH LOCKWASHER AND MOUNTING NUT.

NOTES:
1. PROVIDED WITH LOCKWASHER AND MOUNTING NUT.

NOTES:
1. PROVIDED WITH LOCKWASHER AND MOUNTING NUT.

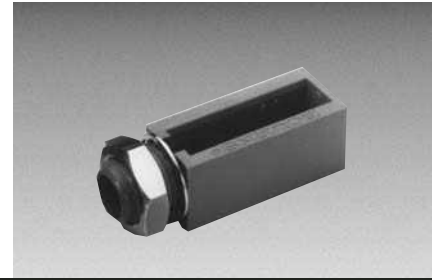
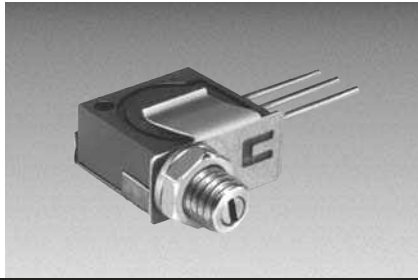
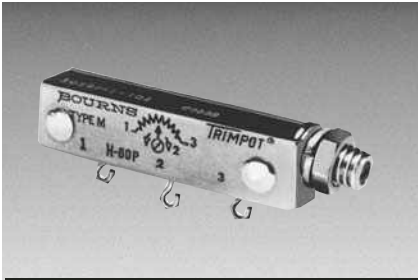

Customer Installed Panel Mount - Unsealed



SEE TABLE II FOR PANEL MOUNT PART NUMBER

H-58P Panel Mount

1-1/4 Inch Rectangular
Multiturn Modules

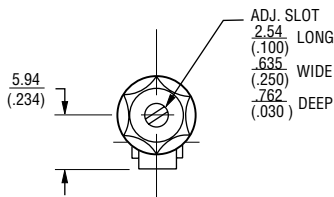
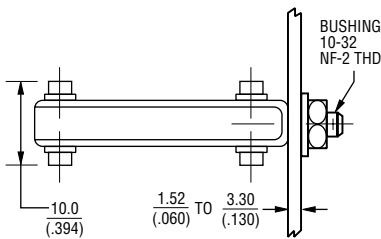
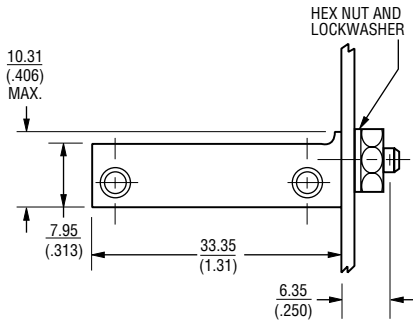

NOTES:

1. PROVIDED WITH LOCKWASHER AND MOUNTING NUT.
2. RECOMMEND PANEL HOLES. #10 DRILL $\frac{.194}{.008}$

*SPECIFY H82 IF PANEL SEAL IS REQUIRED.

H-65P Panel Mount

1/2 Inch Square
Multiturn Models

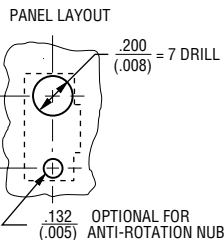
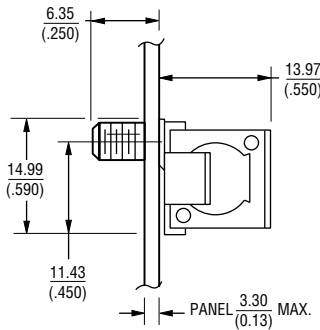
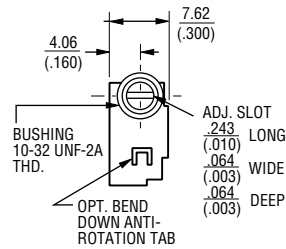

NOTES:

1. PROVIDED WITH LOCKWASHER AND MOUNTING NUT.
2. DRAWINGS SHOWN WITH TRIMMER. ORDER PART SEPARATELY

H-83P Panel Mount

Adapter for Models 3005 AND 3006

The H-83P Adapter is used with Models 3005 and 3006. Order separately and simply snap fit the trimmer in the plastic case. The H-83P with lock-washer and mounting nut is available in 50-piece lots.

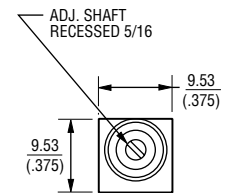
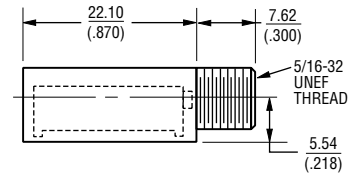

NOTES:

1. DRAWINGS SHOWN WITH TRIMMER. ORDER PART SEPARATELY



Customer Installed Panel Mount BOURNS®

3/8 Inch Square Multiturn Models H-114P/115P/116P Panel Mount

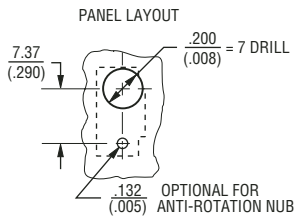
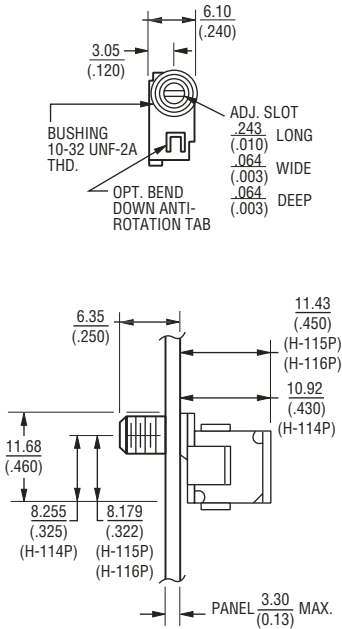

- NOTES:
1. PROVIDED WITH LOCKWASHER AND MOUNTING NUT.
 2. DRAWINGS SHOWN WITH TRIMMER. ORDER PART SEPARATELY

3/8 Inch Square Multiturn Models H-117P Panel Mount

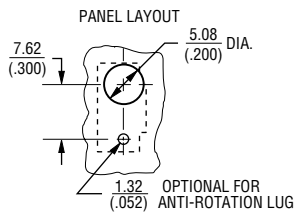
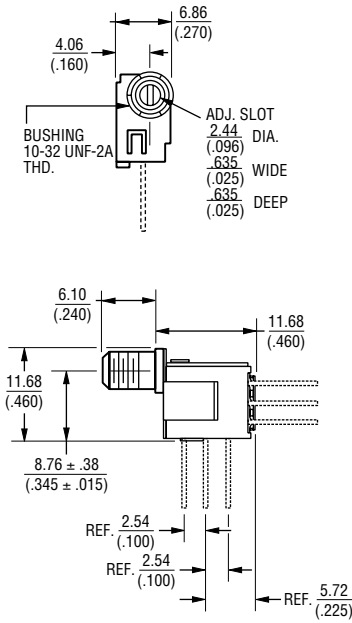

- NOTES:
1. PROVIDED WITH LOCKWASHER AND MOUNTING NUT.
 2. DRAWINGS SHOWN WITH TRIMMER. ORDER PART SEPARATELY

TABLE I
FACTORY INSTALLED
PANEL MOUNTS

STANDARD P/N	P/N WITH PANEL MOUNT
3005P-1-(RC)	3005P-1-(RC) Z
3006P,Y, or W-1-(RC)	3006P,Y, or W-1-(RC) Z
3009P or Y-1-(RC)	3009P or Y-1-(RC) Z
3057L,J,P, or Y-1-(RC)	3057L,J,P, or Y-1-(RC) M
3059L,J,P, or Y-1-(RC)	3059L,J,P, or Y-1-(RC) M
3250L or W-1-(RC)	3250L or W-1-(RC) M
3252L or W-1-(RC)	3252L or W-1-(RC) M
3290 H or W-1-(RC)	3290H or W-1-(RC) M
3292L,W, or X-1-(RC)	3292L,W, or X-1-(RC) M
3296W or X-1-(RC)	3296W or X-1-(RC) M

TABLE II
RETRO-FIT PANEL MOUNTS FOR
INSTALLATION BY CUSTOMER

STANDARD P/N	ORDER PANEL MOUNT P/N
3005P-1-(RC)	H-83P
3006P,Y, or W-1-(RC)	H-83P
3057L,J,P, or Y-1-(RC)	H-58P* SCREW ASSY.
3059L,J,P, or Y-1-(RC)	H-58P* SCREW ASSY.
3250L, W, X-(RC)	H-65P-1*
3252L or W-1-(RC)	H-65P-3*
3252X-1-(RC)	H-65P-5*
3290 H or W-1-(RC)	H-114P*
3292L-1-(RC)	H-115P*
3292W OR X-1-(RC)	H-116P*
RT12P,Y,L	H-58P* SCREW ASSY.
RJ12P,Y	H-58P* SCREW ASSY.
RT22L,W, X, RTR22L,W, X	H-65P-1*
RJ22L,W	H-65P-3*
RJ22X	H-65P-5*
RT24W / RTR24W OR X	H-114P*
RJR24W OR X	H-117P*

*Specify H-82 if panel seal is required.

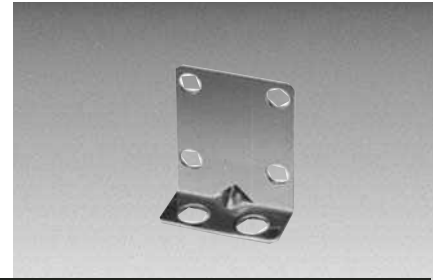
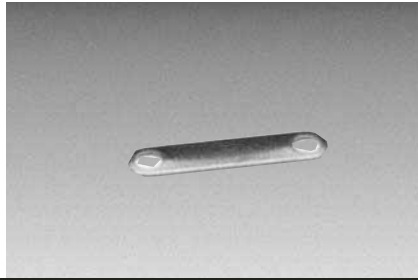
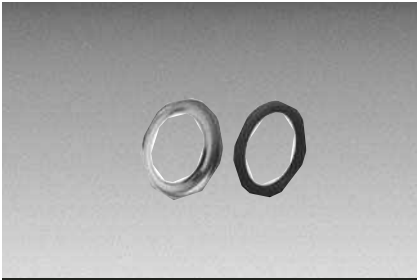

Hardware For Special Mounting Applications **BOURNS®**

H-82 Panel Seal

For all panel mounts with size 10-32 bushings.

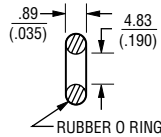
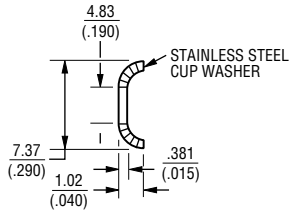

To be used with the following to provide panel seal:

- H-58P
- H-65P-1
- H-65P-3
- H-65P-5
- H-114P
- H-115P
- H-116P
- H-117P

H-25/H-28 Stacking Straps

Models 3250, 3252 (H-25) and 3292 (H-28).

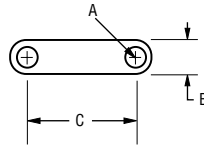

DIMENSIONS	H-25	H-28
A	$\frac{.236}{(.093)}$	$\frac{.178}{(.070)}$
B	$\frac{.363}{(.143)}$	$\frac{.318}{(.125)}$
C	$\frac{1.321}{(.520)}$	$\frac{1.064}{(.419)}$
THICKNESS	.51 (.02)	

H-26S Side Bracket

Models 3250 and 3252
This hardware is available for special mounting applications.

