

Panel cut out(Rear side)

PCB Layout(Component side)

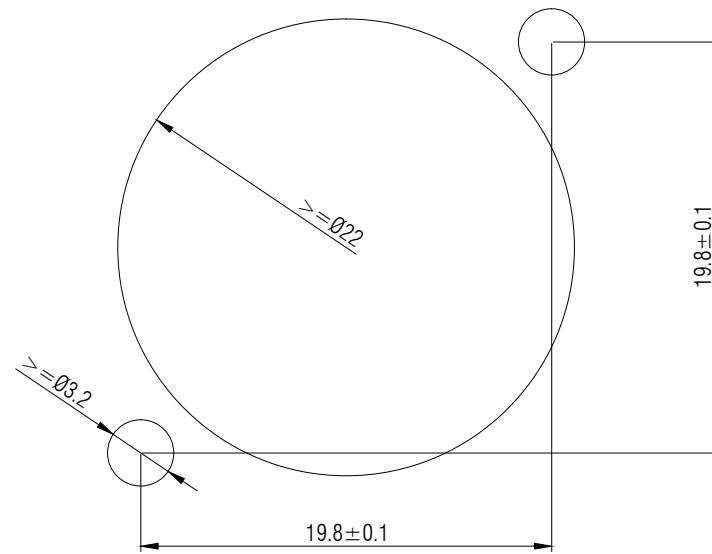
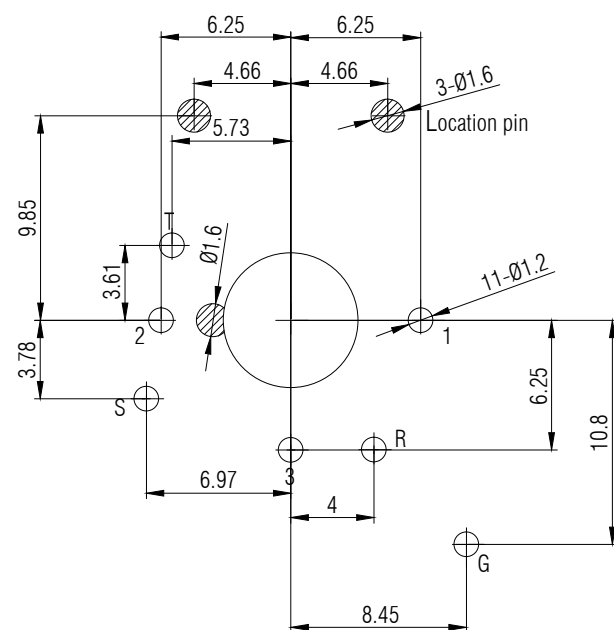

Normalling-Schemes

XLR

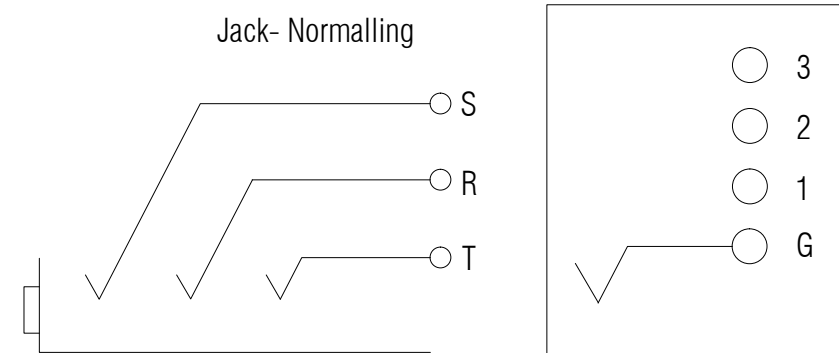

Note:

1. All dimensions in mm.
2. Tolerances not specified is ± 0.20 mm.

THIS DOCUMENT IS THE PROPERTY OF NEUTRIK. NO PART THEREOF MAY BE REPRODUCED AND USED WITHOUT THE PRIOR WRITTEN CONSENT OF THE OWNER				Material:	Scale:	Date:	Name:
					3 : 1 (A3)	2020.01.04	Jacky
Title: RCJ6FA-V-0				Checked:		2020.01.04	Abraham
				Approved:		Replaced By:	
Rev.				Revision Details		Date	Name
				Date		Replaces:	
REAN				Drawing No.:		3.664.036	
				Date		Name	