

E2D108

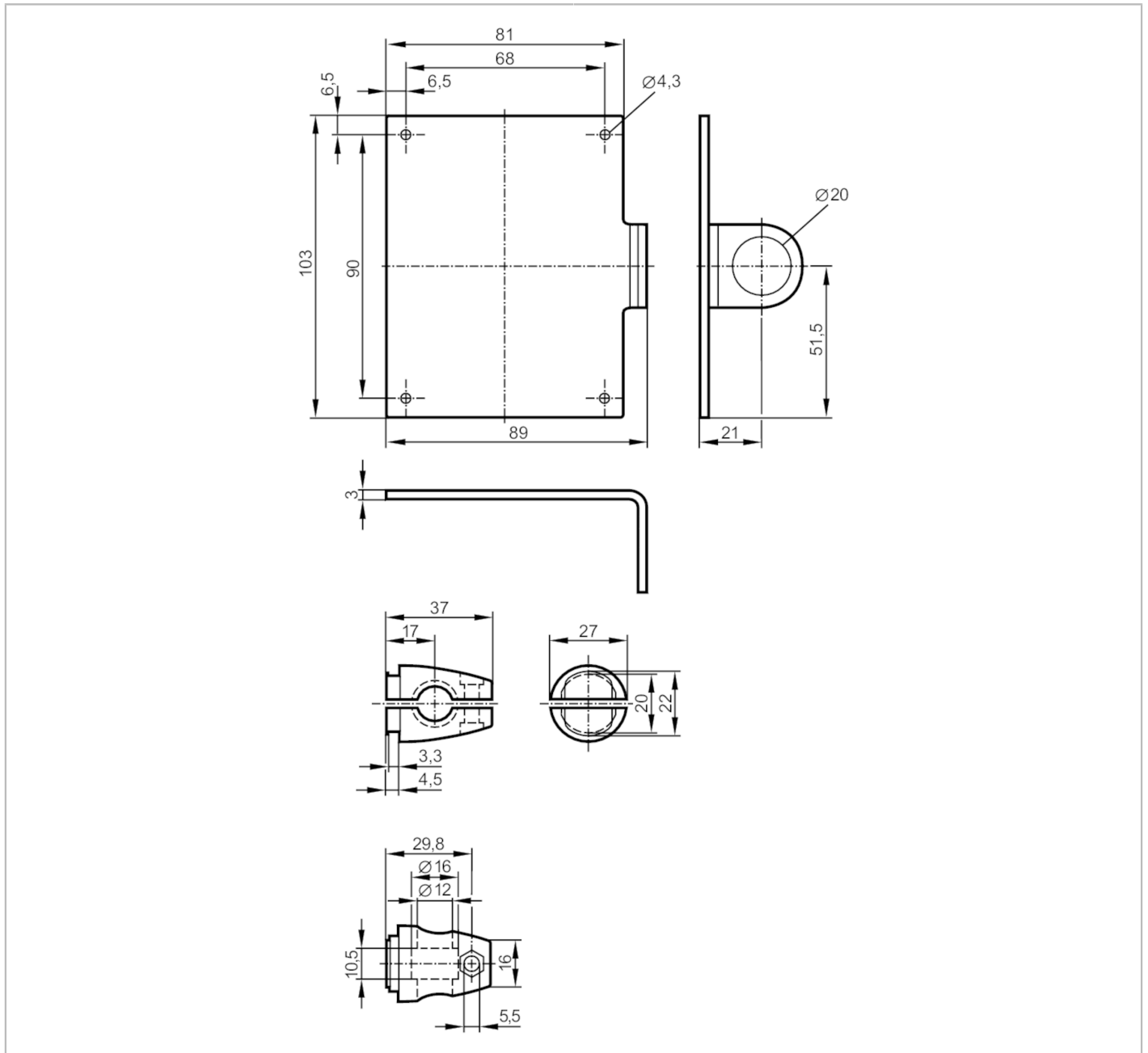

Mounting set for illumination unit

MOUNTING SET BACKLIGHT 50X50



Application	
Design	clamp mounting
Mechanical data	
Weight [g]	314
Materials	Mounting plate: stainless steel (1.4305 / 303); Clamp: stainless steel
Remarks	
Pack quantity	1 pcs.