

Click [here](#) to ask about the production status of specific part numbers.

MAX22000 Evaluation Kit

Evaluates: MAX22000

General Description

The MAX22000 evaluation kit (EV kit) provides the hardware and software necessary to evaluate the MAX22000 industrial configurable analog I/O, both natively, and in conjunction with the MAX14914A industrial digital I/O. The MAX22000 EV kit communicates with a graphical user interface (GUI) running on a PC through a USB port.

Features

- All Modes Accessible: Voltage Input, Voltage Output, Current Input, Current Output, and Temperature Measurement
- Accesses All Spare Inputs
- Includes MAX14914A Industrial Digital I/O
- Windows® 10, Windows 8.1, and Windows 7 Compatible Software
- Proven PCB Layout
- Fully Assembled and Tested

Ordering Information appears at end of data sheet.

MAX22000 EV Kit Photo

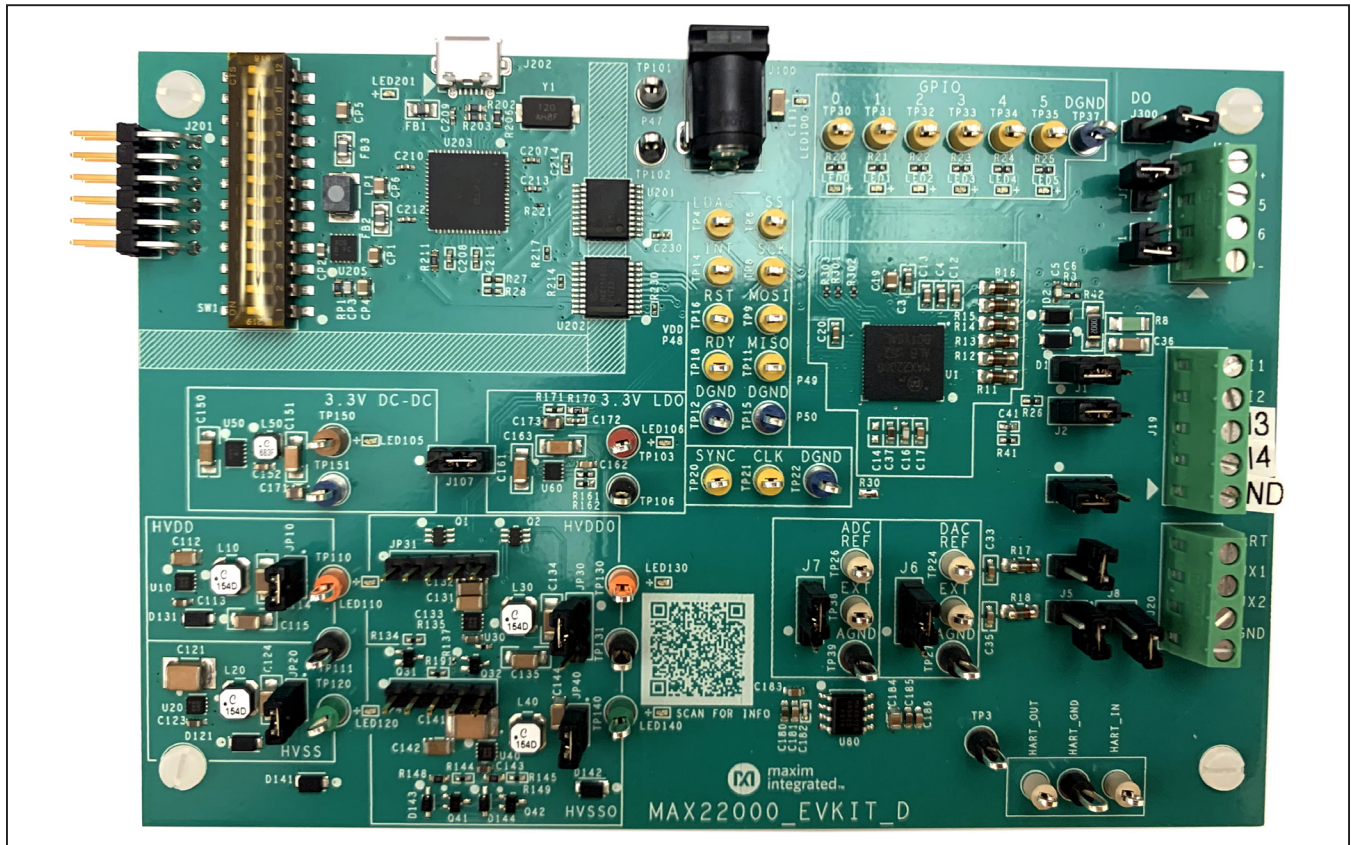

Windows is a registered trademark of Microsoft Corporation.



MAX22000 EV Kit Block Diagram

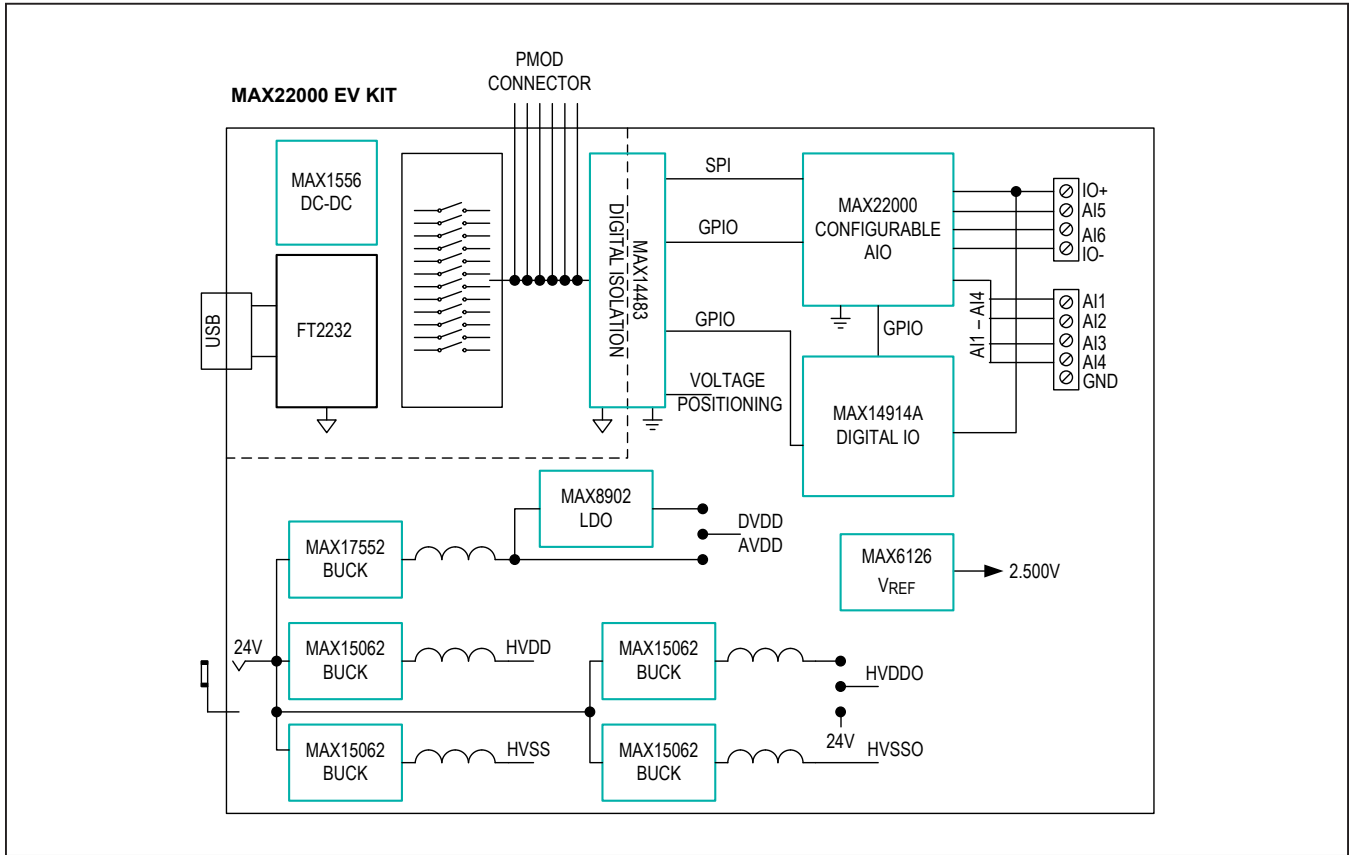

Quick Start

Required Equipment

- MAX22000 EV kit
- Micro-USB cable
- 24V, 1A DC power supply
- Windows 10 or Windows 8.1 PC with a spare USB port
- Multimeter

Note: In the following sections, software-related items are identified by bolding. Text in **bold** refers to items directly from the EV kit software. Text in **bold and underlined** refers to items from the Windows operating system.

Procedure

The EV kit is fully assembled and tested. Follow the steps below to verify board operation before exercising the full features of the device:

- 1) Visit www.maximintegrated.com/evkitsoftware to download the latest version of the EV kit software, MAX22000EVKITSetupV1.0.EXE.
- 2) Install the EV kit software and USB driver on your computer by running the MAX22000EVKITSetupV1.0.EXE program inside the temporary folder. The program files are copied to your PC and icons are created in the Windows **Start | Programs | Maxim Integrated** menu. During software installation, some versions of Windows might show a warning message indicating that this software is from Maxim Integrated. This is not an error condition and it is safe to proceed with installation. Administrator privileges are required to install the USB device driver.
- 3) Verify that all the jumpers are in their default positions, as shown in [Table 1](#).
- 4) Connect the 24V Adapter supplied with the EV kit or use a 24V DC power supply connected on the gray 24V (TP101) and black AGND (TP102) connectors on the EV kit board.
- 5) Connect the multimeter to pins 1 and 4 of J12, and set the multimeter to read voltage.
- 6) Connect the USB cable from the PC to the EV kit board. A Windows message appears when connecting the EV kit board to the PC for the first time. Each version of Windows has a slightly different message. If you see a Windows message stating **ready to use**, then proceed to the next step.
- 7) Start the EV kit software by opening its icon in the Windows **Start | Programs | Maxim Integrated** menu. The EV kit software **Configurable IO** tab appears. Select the **Analog Output** tab, as shown in [Figure 1](#).
- 8) Verify that **Status: MAX22000EVKIT Connected** is displayed on the status bar at the bottom of the application window ([Figure 1](#)).
- 9) In the **AO Mode** drop down, select "Voltage +/-10V"
- 10) Select the Setting edit box and type "10."
- 11) Click the **Set** button. Verify that the multimeter now reads about 10 Volts.
- 10) Select the **Register** tab and click on the **Read All** button to read all of the registers in the device.
- 11) Inspect the bottom 16 bits of register 0x00 (GEN_PROD) and the bottom 16 bits of register 0x01 (GEN_REV) are not all zeroes ([Figure 2](#)).

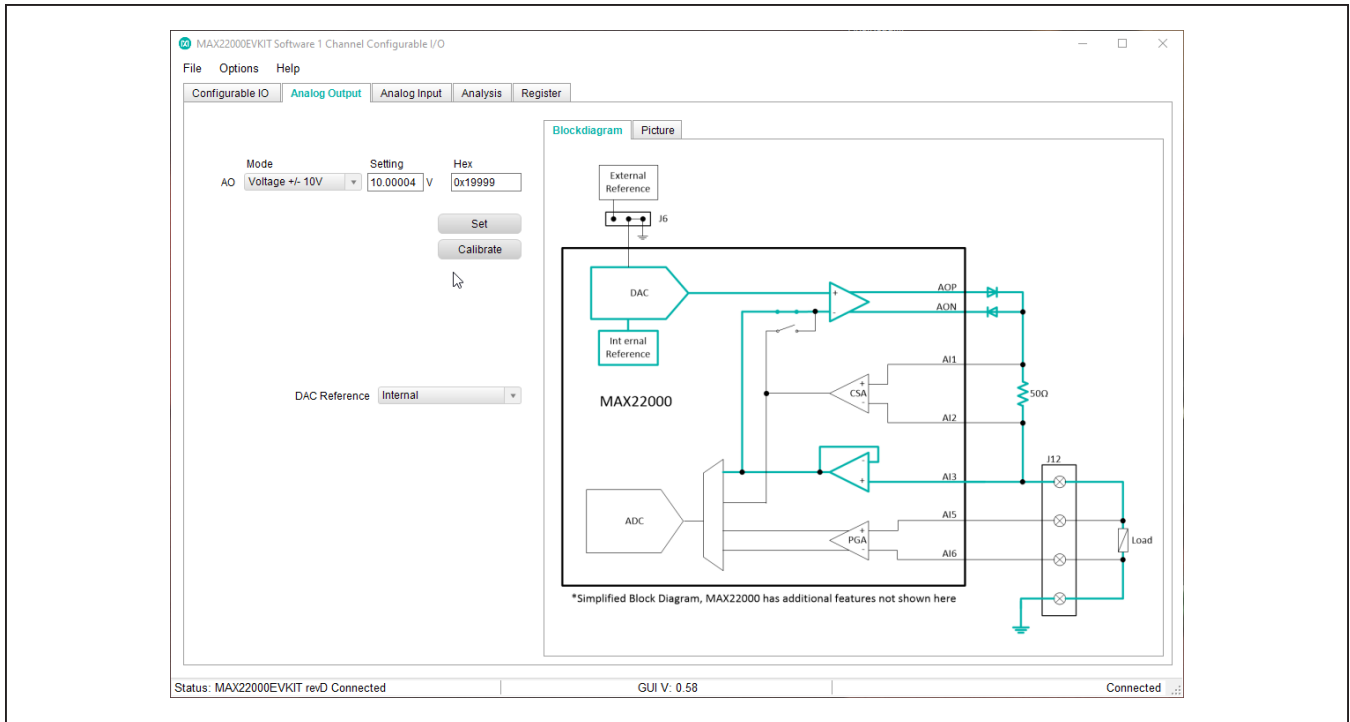

Figure 1. MAX22000 EV Kit Software, Analog Output Test

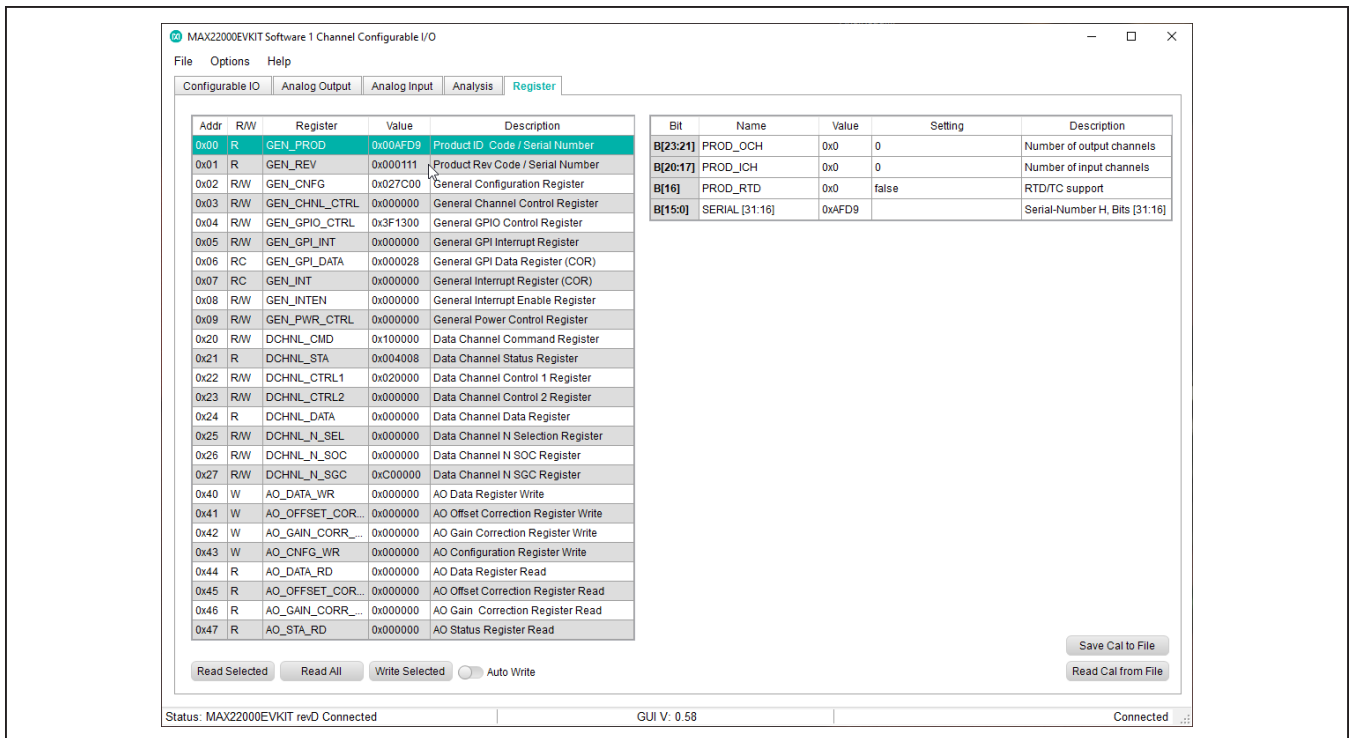

Figure 2. MAX22000 EV Kit Software, Register Access Test

Table 1. Jumper Descriptions

JUMPER	SHUNT POSITON	DESCRIPTION
J1	1-2*	Input AI1 dedicated to analog output-current mode
	2-3	Input AI1 available on J19 pin 6
J2	1-2*	Input AI2 dedicated to analog output-current mode
	2-3	Input AI2 available on J19 pin 5
J3	1-2*	Input AI3 dedicated to analog output-voltage mode
	2-3	Input AI3 available on J19 pin 3
J4	Open	AUX1 input open
	Closed	Connect Thermistor to AUX1 for cold junction compensation for Thermocouple
J5	Open	AUX2 input open
	Closed	Connect Thermistor to AUX2 for cold junction compensation for Thermocouple
J6	1-2	Select on-board 2.500V source for external DAC reference
	2-3*	Use an on-chip reference for DAC (Grounds REF_DAC_EXT)
	Open	Select voltage at TP25 (EXT) for external DAC reference
J7	1-2	Select on-board 2.500V source for external ADC reference
	2-3*	Use on-chip reference for ADC (Grounds REF_ADC_EXT)
	Open	Select voltage at TP38 (EXT) for external ADC reference
J8	Open*	GPIO4 selects between voltage and current measurement at J19 pin 2 to input AI4
	Closed	Force current measurement only at J19 pin 2 to input AI4
J10	Open*	Input AI5 connected to J12 pin 3, high-side remote sense of the analog output
	Closed	Input AI5 connected directly to the high-side of the analog output
J11	Open*	Input AI6 connected to J12 pin 2, low-side remote sense of the analog output
	Closed	Input AI6 connected directly to the low-side of the analog output
JP10	Open	Connect HVDD net to external supply on TP110
	Closed*	Connect HVDD net to on-board +18V regulator
JP20	Open	Connect HVSS net to external supply on TP120
	Closed*	Connect HVSS net to on-board -18V regulator
JP30	1-2*	Connect HVDDO net to on-board voltage positioning (+5V/+10V/+15V) regulator
	2-3	Connect HVDDO net to +24V supply on J100 or TP101
	Open	Connect HVDDO net to supply on TP130
JP40	Open	Connect HVSSO net to external supply on TP140
	Closed*	Connect HVSSO net to on-board voltage positioning (-5V-10V/-15V) regulator
J107	1-2	Connect AVDD and DVDD nets to the output of U50, a MAX17552 buck regulator
	2-3*	Connect AVDD and DVDD nets to the output of U60, a MAX8902B low-voltage post regulator
	Open	Connect AVDD net to external supply on TP150 and DVDD net to external supply on TP103
J300	Open	Analog I/O only, MAX14914A disconnected from J12
	Closed*	Configurable I/O, MAX14914A connected to J12
SW1	Open	MAX22000 control signals disconnected from isolated USB interface, connected to J201 for external control
	Closed*	MAX22000 control signals connected to isolated USB interface from PC

*Default position.

Table 2. Test Point Description

TEST POINT	DESCRIPTION
HART_GND (BLACK)	AGND: co-located with HART test points
HART_IN (WHITE)	HART IN: Input from HART source
HART_OUT (WHITE)	HART OUT: output to HART peripheral
J12 (GREEN)	I/O: Configurable I/O terminal block, consisting of force high, AI5 sense high, AI6 sense low, and return. Includes Digital I/O if J300 is shorted.
J19 (GREEN)	SPARE ANALOG INPUTS: Access to analog inputs, AI1, AI2, AI3, and AI4
TP3 (BLACK)	AGND
TP4 (YELLOW)	LDAC: MAX22000 $\overline{\text{LDAC}}$ pin monitor point
TP6 (YELLOW)	SS: MAX22000 $\overline{\text{CS}}$ pin monitor point
TP8 (YELLOW)	SCK: MAX22000 SCLK pin monitor point
TP9 (YELLOW)	MOSI: MAX22000 SDI pin monitor point
TP10 (WHITE)	AUX1: MAX22000 AUX1 analog input
TP11 (YELLOW)	MISO: MAX22000 SDO pin monitor point
TP12 (GREEN)	DGND: co-located with MAX22000 digital interface monitor points
TP13 (WHITE)	AUX2: MAX22000 AUX2 analog input
TP14 (YELLOW)	INT: MAX22000 $\overline{\text{INT}}$ pin monitor point
TP15 (GREEN)	DGND: co-located with MAX22000 digital interface monitor points
TP16 (YELLOW)	RST: MAX22000 $\overline{\text{RST}}$ pin monitor point
TP17 (BLACK)	AGND: co-located with AUX1 and AUX2 test points
TP18 (YELLOW)	RDY: MAX22000 $\overline{\text{RDY}}$ pin monitor point
TP20 (YELLOW)	SYNC: MAX22000 SYNC pin access, has a 22k Ω pulldown to DGND
TP21 (YELLOW)	CLK: MAX22000 CLK pin access, has a 22k Ω pulldown to DGND
TP22 (GREEN)	DGND: co-located with SYNC and CLK test points
TP24 (WHITE)	DAC REF: MAX22000 REF_DAC monitor point
TP25 (WHITE)	DAC REF EXT: provide an external off-board DAC reference here; see J6
TP26 (WHITE)	ADC REF: MAX22000 REF_ADC monitor point
TP27 (BLACK)	AGND: co-located with DAC reference test points
TP30 (YELLOW)	GPIO0: MAX22000 GPIO0 pin access
TP31 (YELLOW)	GPIO1: MAX22000 GPIO1 pin access
TP32 (YELLOW)	GPIO2: MAX22000 GPIO2 pin access
TP33 (YELLOW)	GPIO3: MAX22000 GPIO3 pin access
TP34 (YELLOW)	GPIO4: MAX22000 GPIO4 pin access
TP35 (YELLOW)	GPIO5: MAX22000 GPIO5 pin access
TP37 (GREEN)	DGND: co-located with GPIO test points
TP38 (WHITE)	ADC REF EXT: provide an external off-board ADC reference here; see J7
TP39 (BLACK)	AGND: co-located with ADC reference test points
TP101 (GRAY)	24V power input
TP102 (BLACK)	DGND: 24V power input return

Table 2. Test Point Description (continued)

TEST POINT	DESCRIPTION
TP103 (RED)	AVDD: external analog supply voltage input, remove R170 if supplied externally
TP106 (BLACK)	AGND: co-located with AVDD supply test point
TP110 (ORANGE)	HVDD: external high-voltage positive analog supply input; see JP10
TP111 (BLACK)	AGND: co-located with HVDD and HVSS supply test points
TP120 (PURPLE)	HVSS: external high-voltage negative supply input, must be more negative than HVSSO
TP130 (ORANGE)	HVDDO: external high-voltage positive drive supply input
TP131 (BLACK)	AGND: co-located with HVDDO and HVSSO supply test points
TP140 (PURPLE)	HVSSO: external high-voltage negative drive supply input
TP150 (BROWN)	DVDD: external digital supply voltage input, remove R170 if DVDD and AVDD are both supplied externally
TP151 (GREEN)	DGND: co-located with DVDD supply test point

Detailed Description of Software

Generating an Analog Output

The Analog Output tab of the MAX22000 EV kit GUI quickly sets a voltage or current at IO+ and IO- of J12. To set a voltage or current:

- Select the desired voltage or current range using the **AO Mode** drop-down
- Enter a voltage or current in the **Setting** edit box
- Click the **Set** button

Instead of a voltage or current value, a specific DAC code can be entered in the **Hex** edit box.

The **DAC Reference** drop-down selects between the on-chip reference and an off-chip reference. With the default jumper configuration, this is a MAX6126 on-board reference, but an off-board reference can also be used. To use an off-board reference, remove any shunt on J6, and supply the reference on TP25.

Analog Output Calibration

The MAX22000 EV kit supports analog output calibration, maintaining unique calibration parameters for each output mode and automatically programming them when the mode changes using the **Analog Output** tab.

To perform a 2-point calibration, first set the **AO Mode** appropriately, then click the **Calibrate** button. The dialog box in [Figure 3](#) appears. Clicking the **DAC Calibrate** push button brings up the **Autocal** dialog box as shown in [Figure 4](#). Using a precision voltmeter or ammeter, measure the voltage or current, and enter the value in the edit box of the **Autocal** dialog box. After clicking **OK**, the **Autocal** dialog box appears a second time, with a new value to report back.

The interface returns to the dialog box in [Figure 3](#). The calibration parameters are now in effect. To have them persist across power cycles of the EV kit, this data is automatically written and all calibration parameters are stored in on-board flash memory.

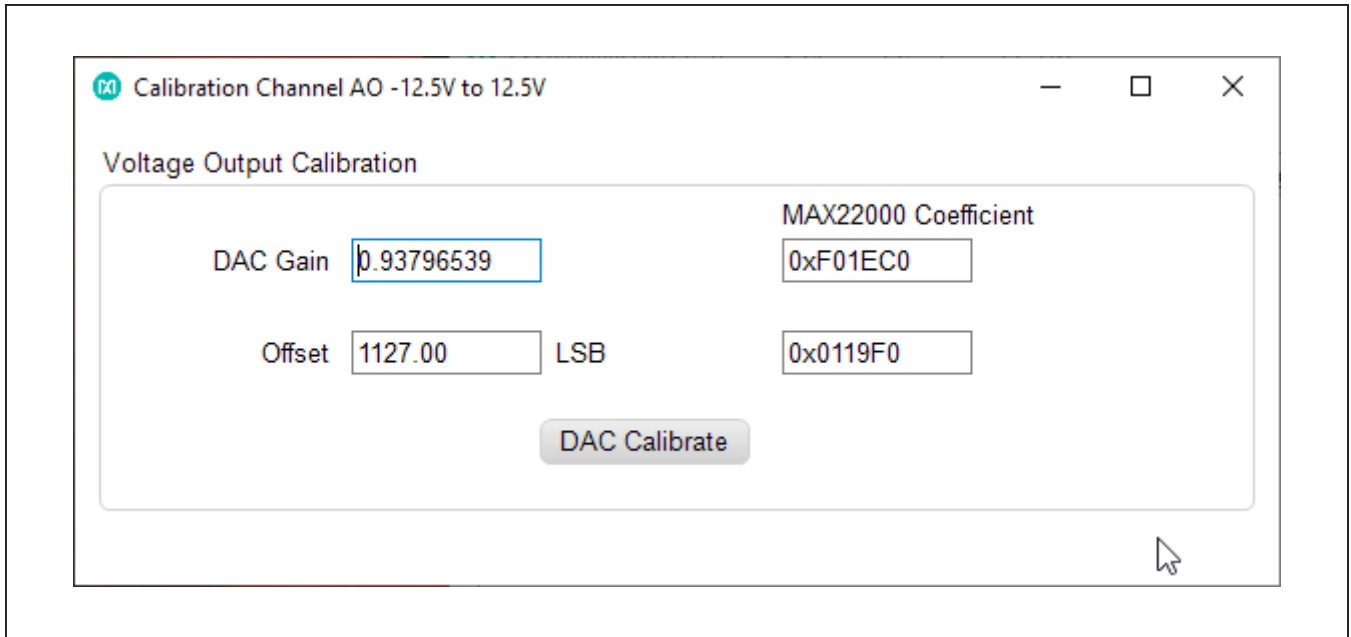

Figure 3. MAX22000 EV Kit Software, DAC Calibration Dialog

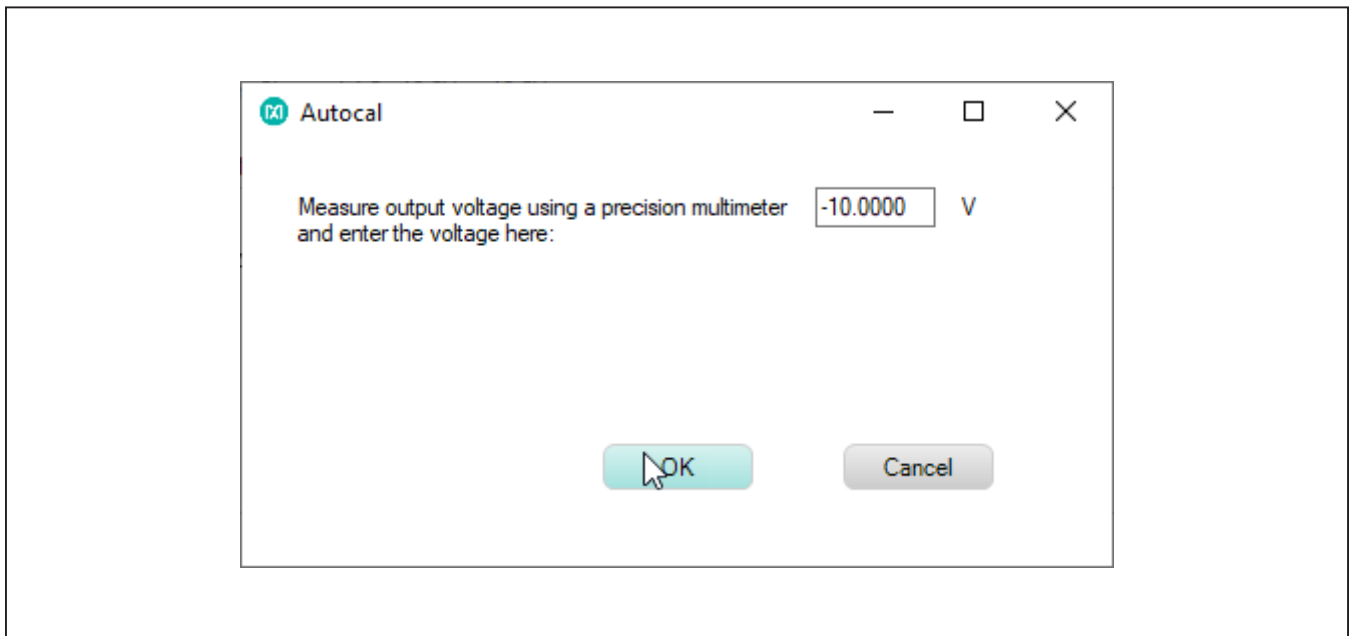

Figure 4. MAX22000 EV Kit Software, Autocal Dialog

Measuring Analog Inputs

To read analog voltages, select the **Analog Input** tab of the MAX22000 EV kit GUI as seen in [Figure 5](#). Clicking the **Read All** button reads all voltages that have their associated check box selected, updating both the voltage and the hex value for those channels.

Some inputs can be combined. For example, channels AI3 and AI4 can form a differential input. The **Mode** drop-downs permit the selection of these alternative inputs. Also, the **AI5/6** drop-down selects from among the various ranges of the PGA supporting those inputs. It is especially important to correctly select from these drop-downs during calibration.

The **ADC Reference** drop-down selects between the on-chip reference and an off-chip reference. With the default jumper configuration, this is a MAX6126 on-board reference, but an off-board reference can also be used. To use an off-board

reference, remove any shunt on J7, and supply the reference on TP38.

Analog Input Calibration

Like the DAC, the ADC supports 2-point calibration. In the case of the ADC, the MAX22000 accepts gain/offset parameter pairs for each possible ADC multiplexer input, automatically switching between them as needed.

To effect calibration, click the corresponding **Calibrate** button. In the **Calibration Channel** dialog box, click the **ADC Calibrate** button. Use a precision source to supply a voltage near the application maximum, and then report that value in the **Autocal** dialog box. Click the **Accept** button. Repeat a second time, using a voltage near the application minimum, All further ADC reads of that channel now correct based on these calibration parameters.

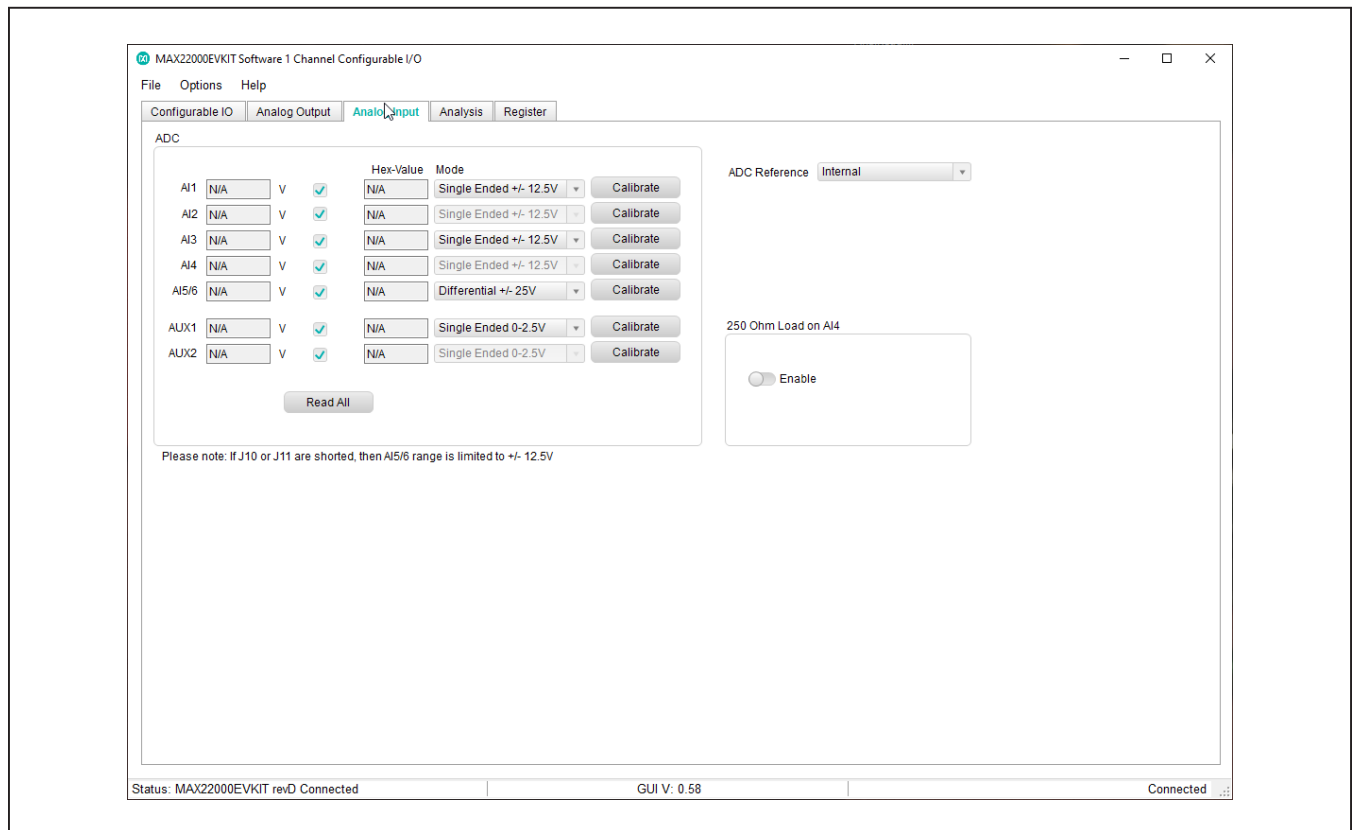

Figure 5. MAX22000 EV Kit Software, Analog Input Tab

Analog and Digital on One Pin

The MAX22000 EV kit includes a MAX14914A industrial digital I/O. Shorting J10, J11, and J300 connects the MAX22000 and the MAX14914A together, forming a configurable (analog or digital) I/O solution.

The **Configurable IO (CIO)** tab controls this feature, refer to [Figure 6](#). The **CIO Mode** drop-down selects from voltage output, current output, digital output, voltage input, current input, or digital input, all electronically switched from J12 pins 1 and 4, IO+ and IO-.

Before leaving the **Configurable IO** tab, ensure that the **CIO Mode** drop-down is set to **Not Setup**.

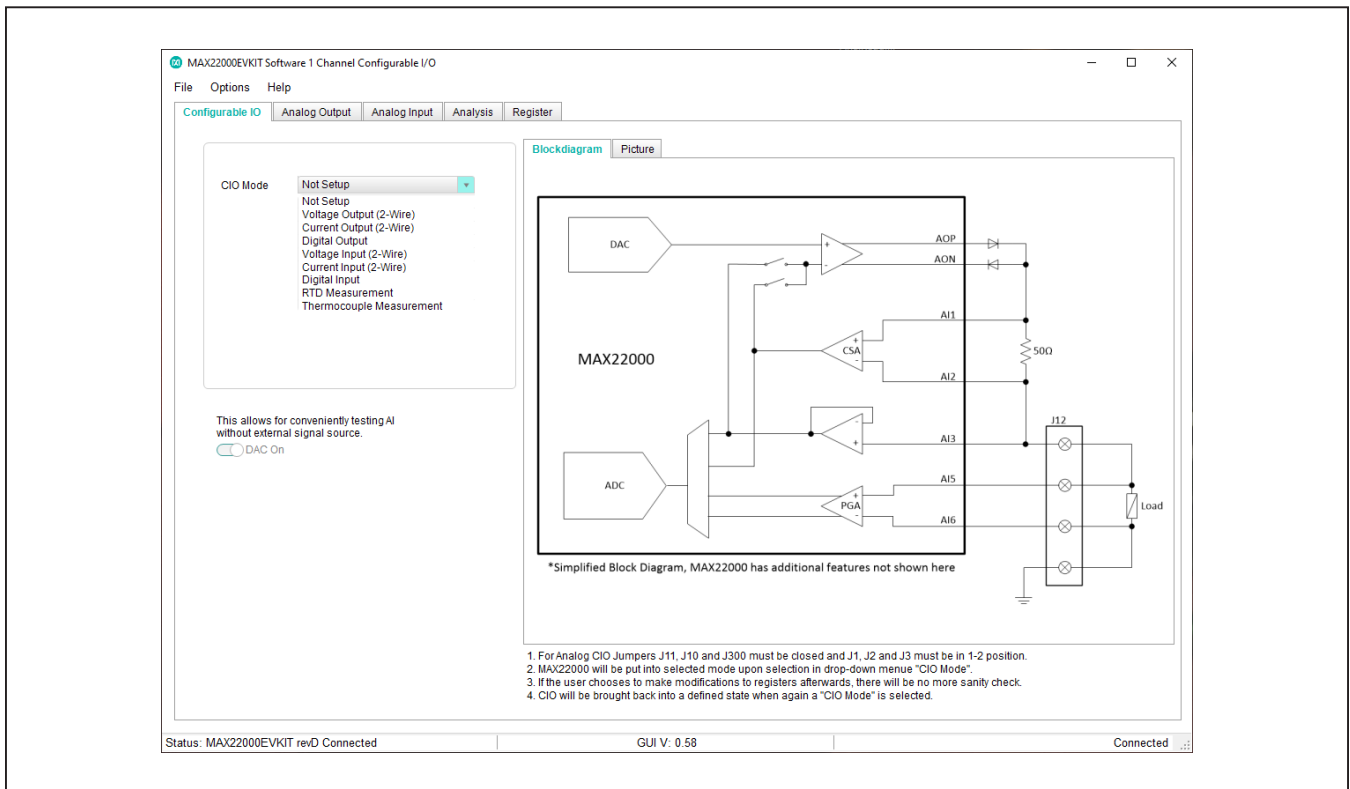

Figure 6. MAX22000 EV Kit Software, Configurable IO Tab

Configuring the Registers (Low Level)

The **Register** tab permits read/write access to individual MAX22000 registers. The left table lists each of the MAX22000 registers. The right table lists the bit fields for any register selected in the left table.

To modify the writeable bits of any register, update either the value in the register table, or the fields in the bit field table, then click the **Write Selected** button.

The row associated with a modified register highlights red until that register is either written or read.

Analysis

The **Analysis** tab shown in [Figure 7](#) permits capture and visual display of any analog-input channel as an oscilloscope format (time) or as a FFT (Frequency) format. In Scope mode the x-axis is either time or a count of the number of samples, while the y-axis is either voltage or current, or LSB format. In FFT mode, the x-axis is frequency (Hz) and the y-axis is dB. Captured data can be saved to an 'Analog Datapoint file' in .csv format. To support system evaluation, a step-response feature is included for the DAC.

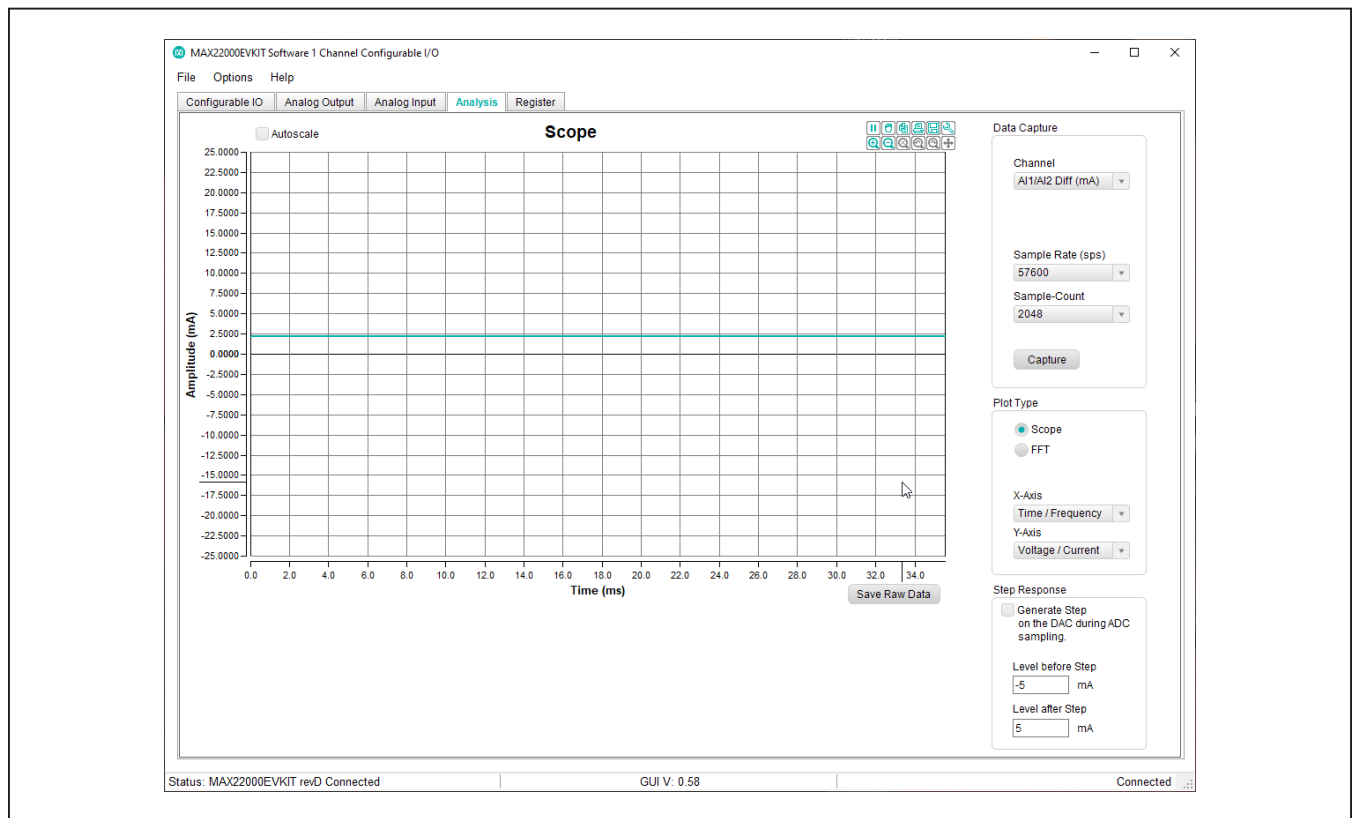

Figure 7. MAX22000 EV Kit Software, Analysis Tab

Detailed Description of Hardware

The MAX22000 EV kit includes the MAX22000 configurable analog I/O, and the external components needed to evaluate the device. All important signals are available on color coded test points.

Isolation Domains

To reduce noise induced to loop currents going off-board, the MAX22000 isolates the connection to a PC through the USB connector.

Most of the MAX22000 EV kit powers through a 24V supply made available either through TP101/TP102, or through J100. Power supply circuits convert this 24V into the HVDD, HVDDO, HVSS, HVSSO, DVDD, and AVDD supplies needed by the MAX22000.

The isolated USB section takes power exclusively from the USB connector J202. Data isolators U201 and U202 (MAX14483) keep the USB grounds separate from the rest of the EV kit circuitry.

Powering Options

The MAX22000 configurable analog I/O needs 6 voltage supplies and has several options to provide these.

The MAX22000 powers its analog input stages from a high-voltage bipolar supply (HVDD and HVSS) referenced to AGND. Though they usually take the same voltages, the analog output supplies (HVDDO and HVSSO) are on distinct pins from their analog input equivalents. HVDDO and HVSSO are also referenced to AGND.

The on-chip data converters power through AVDD, referenced to AGND, and digital logic powers through DVDD, referenced to DGND.

The high-voltage supplies can source from on-board bipolar supplies, or can be powered externally.

Configuring the High-Voltage Supplies

The MAX22000 EV kit makes it easy to provide power through a barrel connector J100. Provide 24V through this connector, positive in the center. If a barrel connector is not handy, the user can instead supply this 24V through TP101 and TP102. LED100, near barrel connector J100, illuminates when voltage is applied either through J100 or TP101/TP102. In the default jumper configuration, $\pm 18V$ supply HVDD/HVSS, $\pm 15V$ supply HVDDO/HVSSO, and $+3.3V$ supply both AVDD and DVDD.

Ensure that the MAX22000 EV kit is unpowered before reconfiguring any jumpers.

To supply HVDD from the on-board $+18V$ supply, ensure that JP10 is closed. If powering off-board, open JP10 and provide a suitable voltage on TP110. LED110 illuminates to confirm that HVDD is powered.

To supply HVSS from the on-board $-18V$ supply, ensure that JP20 is closed. If powering off-board, open JP20 and provide a suitable voltage on TP120. LED120 illuminates to confirm that HVSS is powered.

To supply HVDDO from the on-board $+15V$ supply, ensure that JP30 is in the 1–2 position. If powering off-board, open JP30 and provide a suitable voltage on TP130. LED130 illuminates to confirm that HVDDO is powered.

To supply HVSSO from the on-board $-15V$ supply, ensure that JP40 is closed. If powering off-board, open JP40 and provide a suitable voltage on TP140. LED140 illuminates to confirm that HVSSO is powered.

CAUTION: when configuring HVSS and/or HVSSO externally, recall that HVSSO must never go more negative than HVSS. Refer to the Absolute Maximum rating in the MAX2200 IC data sheet, HVSSO to HVSS of $-0.3V$ to $+40V$.

Configuring for 24V Voltage Output Mode

For most applications, the MAX22000 high-voltage circuits power from a $\pm 15V$ or $\pm 18V$ supply. However, for 24V voltage-output mode or 4mA–20mA output-current mode with 500 Ω load, HVDD/HVDDO need to be about +28V.

To power for these modes select the 2–3 position for JP30, and provide +28V on TP101 and ground on TP102.

Configuring the Low-Voltage Supplies

Besides the four high-voltage supplies described above, the MAX22000 also needs a +3.3V supply on DVDD and a +3.3V supply on AVDD.

Usually, AVDD and DVDD come from the same supply. A filter, consisting of R170, R171, and C172 further cleans up the power rail for AVDD.

In the default jumper configuration, a buck regulator, followed by a linear post-regulator, supply both AVDD and DVDD. Select this by setting J107 to the 2–3 position.

Alternatively, setting J107 to the 1–2 position bypasses the linear post-regulator, supplying AVDD and DVDD directly from the buck regulator. This is a convenience for those users wishing to verify the noise performance of the MAX22000. Most users do not need a post-regulator in their applications.

To power AVDD and DVDD externally, ensure that J107 is open, and provide +3.3V to TP150. This supplies DVDD directly, and AVDD through an RC filter, as described above.

In the rare case where the user wishes to supply DVDD and AVDD separately, unsolder R170 from the MAX22000 EV kit, and supply DVDD to TP150, and AVDD to TP103.

LED105 illuminates to confirm that DVDD is powered, and LED106 illuminates to confirm that AVDD is powered.

Output Configuration Options

The MAX22000 EV kit analog input/output port is very flexible. Under electronic control, it can behave as a voltage output, a current output, a voltage input, or a current input. However, you can trade some of this flexibility for more inputs. [Table 3](#) summarizes how you can trade off output flexibility for more analog inputs.

Depending on the output modes desired, analog inputs AI1, AI2, and AI3 can become available as analog inputs.

AOCM and AICM reserve analog input channels AI1 and AI2. To permit AOCM and/or AICM, select position 1–2 for both J1 and J2. If neither AOCM nor AICM is needed, select position 2–3 for J1 and J2. In this case, AI1 and AI2 are available either as 2 single-ended analog inputs, or as a differential analog input on J19 pins 5 and 6.

AOVM and AIVM reserve analog-input channel AI3. To enable AOVM and/or AIVM, select position 1–2 on J3. If neither AOVM nor AIVM is needed, select position 2–3 for J3. In this case, AI3 is available as an analog input on J19 pin 3.

No matter what output configuration is selected, AI4 is always available as an analog input on J19 pin 2. Also, AI5 and AI6 are available either as a differential analog input on J12 pins 2 and 3.

In addition, analog inputs AUX1 and AUX2 are always available on TP10 and TP13.

Table 3. Input Configuration Options

DESIRED OUTPUT CONFIGURATIONS				AVAILABLE SPARE INPUTS	
AOVM	AOCM	AIVM	AICM	SINGLE-ENDED	DIFFERENTIAL
√	√	√	√	AI4	AI5-AI6 ($\pm 25V$, PGA)
√		√		AI1, AI2, AI4	AI5-AI6 ($\pm 25V$, PGA)
√		√		AI4	AI1-AI2 ($\pm 1.25V$) AI5-AI6 ($\pm 25V$, PGA)
	√		√	AI3, AI4	AI5-AI6 ($\pm 25V$, PGA)
	√		√	NONE	AI3-AI4 ($\pm 25V$) AI5-AI6 ($\pm 25V$, PGA)

AOVM = Analog Output-Voltage Mode

AOCM = Analog Output-Current Mode

AIVM = Analog Input-Voltage Mode

AICM = Analog Input-Current Mode

ADC Reference Options

Besides the on-chip reference in the MAX22000, the MAX22000 EV kit also provides an on-board reference, as well as the means to connect an off-board bench reference.

To choose the on-chip reference for the ADC, select the internal ADC reference in the GUI, and ensure that J7 is in the 2–3 position.

To choose the on-board reference, select the external ADC reference in the GUI, and ensure that J7 is in the 1–2 position.

To choose an off-board reference, select external ADC reference in the GUI, ensure that J7 is open, and provide a 2.500V reference voltage on TP38.

DAC Reference Options

Besides the on-chip reference on the MAX22000, the MAX22000 EV kit also has an on-board reference, as well as the means to connect an off-board bench reference.

To choose the on-chip reference for the DAC, select the internal DAC reference in the GUI and ensure that J6 is in the 2–3 position.

To choose the on-board reference, select the external DAC reference in the GUI and ensure that J6 is in the 1–2 position.

To choose an off-board reference, select an external ADC reference in the GUI, ensure that J6 is open, and provide a 2.500V reference voltage on TP25.

AI4 as a Voltage or Current Input

As an example, AI4 can measure either voltage or current, electronically. GPIO4 effects this control when programmed as an output.

Measure current setting GPIO4 high to switch in a 250Ω current-to-voltage conversion resistor. Setting GPIO4 low removes this resistor and measures voltage instead.

This can also be done manually through jumper J8. Closing J8 connects the resistor. To electronically remove the 250Ω resistor from the circuit, both J8 must be open, and GPIO4 must drive low. Do not leave GPIO4 as an input when measuring a signal on AI4. The control signal to the analog switch is in an indeterminate state in this case.

Refer to [Application Note AN7134](#) MAX22000 Software Configurable Universal Analog I/O for more details of all the modes of use.

Analog/Digital Combination

The MAX22000 EV kit includes a MAX14914A that parallels the MAX22000 on its output. Using some of

the MAX22000 GPIO, the GUI communicates with the MAX14914A, allowing J12 to provide a truly configurable industrial I/O port. Refer to [Application Note AN7133](#) Configurable Analog-Digital Input/Output Modes (CIO) for PLC Systems using MAX22000 and MAX14914A for more details.

HART Communication

The MAX22000 EV kit allows highway-addressable remote transducer (HART) protocol communication with external HART enabled sensors. Connect an external HART modem with the appropriate resistive or capacitive divider between J20.4 (HART) and J20.1 (GND) test points. For more details regarding HART communication, refer to the MAX22000 data sheet.

Temperature Measurement

The MAX22000 EV kit supports temperature measurement by connecting an external resistive-temperature detector (RTD) or thermocouple (TC) sensor. Select the desired sensor type from the drop down menu in Configurable IO tab as shown in [Figure 6](#). The GUI block diagram shows the proper connection for the sensor. Refer to [Application Note AN7186](#) Guidelines to Implementing Temperature Measurements with the MAX22000 for more details.

Communicating with the MAX22000

The MAX22000 EV kit communicates to a PC through a commonly available A-to-micro-B cable. Since there is no on-board microprocessor, all coordination and low-level SPI transactions are managed by code on the PC, as part of the GUI. This is ideal for quick evaluation and to explore the features and functions of the MAX22000.

For users who prefer more direct control through their own hardware, important signals are made available through J201, a 6x2 header with 0.1" spacing that is sometimes called a PMod header, making it compatible with many FPGA and microcontrollers systems. As well as independent dedicated connection, J201 can also be paired with Maxim's USB2GPIO control card. If J201 is used, disconnect the PC interface from the MAX22000 EV kit by opening all switches on SW1.

Ordering Information

PART	TYPE
MAX22000EVKIT#	EV Kit

#Denotes RoHS compliant.

MAX22000 EV Kit Bill of Materials

ITEM	QTY	REF DES	VAR STATUS	MAXINV	MFG PART #	MANUFACTURER	VALUE	DESCRIPTION
1	15	C1-C4, C9, C11, C15, C37, C38, C113, C123, C133, C143, C180, C185	Pref	20-0001U-R1	GRM188R70J105KA01; CL10B105KQ8N8NNC	MURATA; SAMSUNG ELECTRONICS	1.0µF	CAPACITOR; SMT (0603); CERAMIC; 1µF; 6.3V; TOL=10%; MODEL=GRM SERIES; TG = -55°C TO +125°C; TC = X7R; NOT RECOMMENDED FOR NEW DESIGN-USE 20-0001u-63
2	1	C5	Pref	20-0047P-26	06035A470KAT2A	AVX	47PF	CAPACITOR; SMT (0603); CERAMIC CHIP; 47PF; 50V; TOL = 10%; TG = -55°C TO +125°C; TC = C0G
3	1	C6	Pref	20-0047P-F3	C1005C0G1H470F050; GRM1555C1H470FA01	TDK;MURATA	47PF	CAPACITOR; SMT (0402); CERAMIC CHIP; 47PF; 50V; TOL = 1%; TG = -55°C TO +125°C; TC = C0G
4	10	C7, C8, C22, C23, C36, C112, C122, C132, C142, C150	Pref	20-0001U-72	C1206C105K5RAC; GRM31CR71H105KA61; GRM31MR71H105KA88; GCM31MR71H105KA55; CGA5L3X7R1H105K160AB; C3216X7R1H105K160AE	KEMET;MURATA; MURATA;MURATA; TDK;TDK	1µF	CAPACITOR; SMT (1206); CERAMIC CHIP; 1µF; 50V; TOL = 10%; TG = -55°C TO +125°C; TC=X7R
5	7	C12, C21, C24, C27, C181, C183, C186	Pref	20-000U1-R1	C0603C104K9RAC; GRM188R70J104KA01	KEMET;MURATA	0.1µF	CAPACITOR; SMT (0603); CERAMIC CHIP; 0.1µF; 6.3V; TOL = 10%; MODEL = ; TG = -55°C TO +125°C; TC = X7R; NOT RECOMMENDED FOR NEW DESIGN-USE 20-000u1-01
6	1	C13	Pref	20-0001U-63	C0603C105K4RAC; GRM188R71C105KA12; C1608X7R1C105K080AC; EMK107B7105KA; GCM188R71C105KA64; CGA3E1X7R1C105K080AC	KEMET;MURATA; TDK;TAIYO YUDEN; MURATA;TDK	1µF	CAPACITOR; SMT (0603); CERAMIC CHIP; 1µF; 16V; TOL = 10%; MODEL = ; TG = -55°C TO +125°C; TC = X7R
7	1	C16	Pref	20-0100P-15	06035C101JAT	AVX	100PF	CAPACITOR; SMT (0603); CERAMIC CHIP; 100PF; 50V; TOL = 5%; TG = -55°C TO +125°C; TC = X7R
8	3	C17, C18, C162	Pref	20-00U01-11	GRM188R71C103KA01; ECJ-1VB1C10; CL10B103K08N8NN; GCJ188R71C103KA01	MURATA; PANASONIC; SAMSUNG; MURATA	0.01UF	CAPACITOR; SMT (0603); CERAMIC CHIP; 0.01µF; 16V; TOL = 10%; TG = -55°C TO +125°C; TC = X7R
9	2	C19, C184	Pref	20-004U7-S6	GRM21BR71A475KA73; LMK212B7475K-G-T; C2012X7R1A475K125AC	MURATA; TAIYO YUDEN;TDK	4.7µF	CAPACITOR; SMT (0805); CERAMIC CHIP; 4.7µF; 10V; TOL = 10%; TG = -55°C TO +125°C; TC = X7R
10	2	C20, C152	Pref	20-00U22-12	C0603C224K3RAC; GMC10X7R224K25; GRM188R71E224KA88; C1608X7R1E224K080AC	KEMET;MURATA; MURATA;TDK	0.22µF	CAPACITOR; SMT (0603); CERAMIC CHIP; 0.22µF; 25V; TOL = 10%; TG = -55°C TO +125°C; TC = X7R
11	8	C28-C35	Pref	20-3300P-M8	C0603C332K2RAC	KEMET	3300PF	CAP; SMT (0603); 3300PF; 10%; 200V; X7R; CERAMIC CHIP
12	1	C41	Pref	20-1000P-E7	C0402C102K5GAC	KEMET	1000PF	CAPACITOR; SMT (0402); CERAMIC CHIP; 1000PF; 50V; TOL = 10%; MODEL = ; TG = -55°C TO +125°C; TC = C0G
13	10	C111, C114, C115, C124, C125, C131, C134, C135, C144, C145	Pref	20-0010U-Y6	C3216X5R1H106K160AB; GRM31CR61H106KA12	TDK;MURATA	10µF	CAPACITOR; SMT (1206); CERAMIC CHIP; 10µF; 50V; TOL = 10%; TG = -55°C TO +85°C; TC=X5R
14	2	C121, C141	Pref	20-0001U-X8	C4532X7R2A105M230KA	TDK	1µF	CAPACITOR; SMT (1812); CERAMIC CHIP; 1µF; 100V; TOL = 20%; MODEL = C SERIES; TG = -55°C TO +125°C; TC = X7R
15	3	C151, C161, C163	Pref	20-0010U-A4	GRM31CR71E106KA12; CL31B106KAH8NN	MURATA; SAMSUNG ELECTRONICS	10µF	CAPACITOR; SMT (1206); CERAMIC CHIP; 10µF; 25V; TOL = 10%; TG = -55°C TO +125°C; TC = X7R
16	2	C171, C173	Pref	20-0022U-CA99	C2012X5R1V226M125AC	TDK	22µF	CAPACITOR; SMT (0805); CERAMIC CHIP; 22µF; 35V; TOL = 20%; TG = -55°C TO +85°C; TC = X5R

MAX22000 EV Kit Bill of Materials (continued)

ITEM	QTY	REF DES	VAR STATUS	MAXINV	MFG PART #	MANUFACTURER	VALUE	DESCRIPTION
17	1	C172	Pref	20-1000P-27	GRM1555C1H102JA01; C1005C0G1H102J050	MURATA;TDK	1000PF	CAPACITOR; SMT (0402); CERAMIC CHIP; 1000PF; 50V; TOL = 5%; TG = -55°C TO +125°C
18	1	C182	Pref	20-0047P-E7	C0402C470K5GAC	KEMET	47PF	CAPACITOR; SMT (0402); CERAMIC CHIP; 47PF; 50V; TOL = 10%; MODEL = C0G; TG = -55°C TO +125°C; TC = ±
19	1	C201	Pref	20-00U01-BA47	C1005X7R1V103K050BB	TDK	0.01µF	CAPACITOR; SMT (0402); CERAMIC CHIP; 0.01µF; 35V; TOL = 10%; TG = -55°C TO +125°C; TC = X7R
20	2	C202, C203	Pref	20-0018P-27	C0402C180J5GAC; GRM1555C1H180JA01; C1005C0G1H180J050BA	KEMET;MURATA; TDK	18PF	CAPACITOR; SMT (0402); CERAMIC CHIP; 18PF; 50V; TOL = 5%; TG = -55°C TO +125°C; TC = C0G
21	1	C204	Pref	20-004U7-16	C0603C475K8PAC; LMK107BJ475KA; CGB3B1X5R1A475K; C1608X5R1A475K080AC; CL10A475KPB8NNN	KEMET; TAIYO YUDEN; TDK;TDK; SAMSUNG ELECTRONICS	4.7µF	CAPACITOR; SMT (0603); CERAMIC CHIP; 4.7µF; 10V; TOL = 10%; TG = -55°C TO +85°C; TC = X5R
22	13	C205-C215, C230, C231	Pref	20-000U1-31	C0402C104J4RAC; GCM155R71C104JA55	KEMET;MURATA	0.1µF	CAPACITOR; SMT (0402); CERAMIC CHIP; 0.1µF; 16V; TOL = 5%; MODEL = ; TG = -55°C TO +125°C; TC = X7R
23	1	C301	Pref	20-0001U-04	GRM21BR71H105KA12; CL21B105KBFNNN; C2012X7R1H105K085AC; UMK212B7105KG; CGA4J3X7R1H105K125AB	MURATA; SAMSUNG ELECTRONICS; TDK;TAIY	1µF	CAPACITOR; SMT (0805); CERAMIC CHIP; 1µF; 50V; TOL = 10%; TG = -55°C TO +125°C; TC=X7R
24	1	C302	Pref	20-000U1-16B	C1005X5R1A104K050BA; LMK105BJ104KV	TDK;TAIYO YUDEN	0.1UF	CAPACITOR; SMT (0402); CERAMIC CHIP; 0.1µF; 10V; TOL = 10%; TG = -55°C TO +85°C; TC = X5R
25	1	C303	Pref	20-0001U-P6	GRM188R71E105KA12; CGA3E1X7R1E105K; TMK107B7105KA; 06033C105KAT2A; GCM188R71E105KA64; C1608X7R1E105K080AE; CGA3E1X7R1E105K080AC	MURATA;TDK; TAIYO YUDEN;AVX; MURATA; TAIYO YUDEN;TDK	1µF	CAPACITOR; SMT (0603); CERAMIC CHIP; 1µF; 25V; TOL = 10%; TG = -55°C TO +125°C; TC = X7R
26	1	CP1	Pref	20-0010U-23A	CL21A106K0QNNN; GRM21BR61C106KE15; EMK212ABJ106KD	SAMSUNG ELECTRONICS; MURATA; TAIYO YUDEN	10µF	CAPACITOR; SMT (0805); CERAMIC CHIP; 10µF; 16V; TOL = 10%; TG = -55°C TO +85°C; TC = X5R
27	1	CP2	Pref	20-0001U-03	UMK107BJ105KA; C1608X5R1H105K080AB; CL10A105KB8NNN; GRM188R61H105KAAL	TAIYO YUDEN; TDK; SAMSUNG; MURATA	1µF	CAPACITOR; SMT (0603); CERAMIC CHIP; 1µF; 50V; TOL = 10%; MODEL = _MK SERIES; TG = -55°C TO +85°C
28	1	CP3	Pref	20-1000P-77	GRM1885C1H102JA01; C1608C0G1H102J080AA; GCM1885C1H102JA16	MURATA; TDK;MURATA	1000PF	CAPACITOR; SMT (0603); CERAMIC CHIP; 1000PF; 50V; TOL = 5%; TG = -55°C TO +125°C
29	1	CP4	Pref	20-0022U-K7	C0805C226M9PAC; GRM21BR60J226ME39; JMK212BJ226MG; CL21A226MQCLQN	KEMET;MURATA; TAIYO YUDEN; SAMSUNG EL	22µF	CAPACITOR; SMT (0805); CERAMIC CHIP; 22µF; 6.3V; TOL = 20%; TG = -55°C TO +125°C; TC = X5R
30	2	CP5, CP6	Pref	20-004U7-89	GRM21BR71C475KA73; 0805YC475KAT2A; GCM21BR71C475KA73; CGA4J3X7R1C475K125AE	MURATA;AVX; MURATA;TDK	4.7µF	CAPACITOR; SMT (0805); CERAMIC CHIP; 4.7µF; 16V; TOL = 10%; MODEL = GRM SERIES; TG = -55°C TO +125°C; TC = X7R
31	6	D1, D2, D121, D131, D141, D142	Pref	30-DFLS1150-00	DFLS1150	DIODES INCORPORATED	DFLS1150	DIODE; RECT; SMT (POWERDI-123); PIV = 150V; IF = 1A
32	1	D13	Pref	30-SMBJ36CA-00	SMBJ36CA	FAIRCHILD SEMICONDUCTOR	36V	DIODE; TVS; SMB (DO-214AA); VRM = 36V; IPP = 10.3A
33	2	D143, D144	Pref	30-MMSZ5226BS-00	MMSZ5226BS-7-F	DIODES INCORPORATED	3.3V	DIODE; ZNR; SMT (SOD-323); Vz = 3.3V; Izm = 0.01A

MAX22000 EV Kit Bill of Materials (continued)

ITEM	QTY	REF DES	VAR STATUS	MAXINV	MFG PART #	MANUFACTURER	VALUE	DESCRIPTION
34	1	D211	Pref	30-LGL29KG2J124-00	LG L29K-G2J1-24	OSRAM	LG L29K-G2J1-24	DIODE; LED; SMT (0603); Vf = 1.7V; If(test) = 0.002A; -40°C TO +100°C
35	1	FB1	Pref	50-00600-SM2	BLM21AG601SN1	MURATA	600	INDUCTOR; SMT (0805); FERRITE-BEAD; 600; TOL = ±25%; 0.2A
36	2	FB2, FB3	Pref	51-00330-0AP	BLM21PG331SN1	MURATA	330	INDUCTOR; SMT (0805); FERRITE-BEAD; 330; TOL = ±25%; 1.5A
37	8	HART_GND, TP3, TP27, TP39, TP102, TP106, TP111, TP131	Pref	02-TPMINI5011-00	5011	KEYSTONE	N/A	TEST POINT; PIN DIA = 0.125IN; TOTAL LENGTH = 0.445IN; BOARD HOLE = 0.063IN; BLACK; PHOSPHOR BRONZE WIRE SILVER PLATE FINISH; RECOMMENDED FOR BOARD THICKNESS=0.062IN; NOT FOR COLD TEST
38	6	HART_IN, HART_OUT, TP24-TP26, TP38	Pref	02-TPCOMP5007-00	5007	KEYSTONE	N/A	TEST POINT; PIN DIA = 0.125IN; TOTAL LENGTH = 0.35IN; BOARD HOLE = 0.063IN; WHITE; PHOSPHOR BRONZE WIRE SILVER PLATE FINISH; RECOMMENDED FOR BOARD THICKNESS = 0.062IN; NOT FOR COLD TEST
39	1	IC300	Pref	00-SAMPLE-01	MAX14914AATE+	MAXIM	MAX14914AATE+	EVKIT PART - IC; SWTC; PACKAGE OUTLINE DRAWING: 21-0139; LAND PATTERN NUMBER: 90-0070; TQFN16-EP
40	7	J1-J3, J6, J7, J107, JP30	Pref	01-929647090313P-17	929647-09-03-I	3M	929647-09-03-I	CONNECTOR; MALE; THROUGH HOLE; 929 SERIES; STRAIGHT; 3PINS
41	9	J4, J5, J8, J10, J11, J300, JP10, JP20, JP40	Pref	01-PEC02SAAN2P-21	PEC02SAAN	SULLINS	PEC02SAAN	CONNECTOR; MALE; THROUGH HOLE; BREAKAWAY; STRAIGHT; 2PINS
42	2	J12, J20	Pref	01-17270364P-25	1727036	PHOENIX CONTACT	1727036	CONNECTOR; FEMALE; THROUGH HOLE; GREEN PCB TERMINAL BLOCK; STRAIGHT; 4PINS
43	1	J19	Pref	01-17270495P-25	1727049	PHOENIX CONTACT	1727049	CONNECTOR; THROUGH HOLE; GREEN TERMINAL BLOCK; RIGHT ANGLE; 5PINS
44	1	J100	Pref	01-PJ202AH3P-27	PJ-202AH	CUI INC.	PJ-202AH	CONNECTOR; MALE; THROUGH HOLE; DC POWER JACK; RIGHT ANGLE; 3PINS
45	1	J201	Pref	01-TSW10608SDRA12P-17	TSW-106-08-S-D-RA	SAMTEC	TSW-106-08-S-D-RA	CONNECTOR; THROUGH HOLE; POST TERMINAL STRIP ASSEMBLY; RIGHT ANGLE; 12PINS; NOTE: ALTERNATE PIN NUMBERING
46	1	J202	Pref	01-ZX62RDAB5P8305P-26	ZX62RD-AB-5P8(30)	HIROSE ELECTRIC CO LTD.	ZX62RD-AB-5P8(30)	CONNECTOR; MALE; THROUGH HOLE; MICRO-USB CONNECTOR MEETING REQUIREMENTS OF USB 2.0 STANDARD; RIGHT ANGLE; 5PINS
47	2	JP31, JP41	Pref	01-PBC05SAAN5P-21	PBC05SAAN	SULLINS ELECTRONICS CORP.	PBC05SAAN	CONNECTOR; MALE; THROUGH HOLE; BREAKAWAY; STRAIGHT; 5PINS; -65°C TO +125°C
48	4	L10, L20, L30, L40	Pref	50-0150U-0XT	LPS4018-154MR	COILCRAFT	150µH	INDUCTOR; SMT; FERRITE; 150µH; 20%; 0.40A
49	1	L50	Pref	50-0068U-0LH	LPS3015-683MR	COILCRAFT	68µH	INDUCTOR; SMT; FERRITE CORE; 68µH; TOL = ±20%; 0.33A
50	14	LED0-LED5, LED100, LED105, LED106, LED110, LED120, LED130, LED140, LED201	Pref	30-SMLP12PT-00	SML-P12PT	ROHM	SML-P12PT	DIODE; LED; SML-P1 SERIES; ULTRA COMPACT HIGH BRIGHTNESS LED; GREEN; SMT (0402); VF = 2.2V; IF = 0.02A

MAX22000 EV Kit Bill of Materials (continued)

ITEM	QTY	REF DES	VAR STATUS	MAXINV	MFG PART #	MANUFACTURER	VALUE	DESCRIPTION
51	1	LP1	Pref	50-003U3-0EO	B82432T1332K000	TDK	3.3UH	INDUCTOR; SMT (1812); FERRITE CORE; 3.3µH; TOL = ±10%; 0.9A
52	2	Q1, Q2	Pref	90-BSS84DW7F-19	BSS84DW-7-F	DIODES INCORPORATED	BSS84DW-7-F	TRAN; DUAL P-CHANNEL ENHANCEMENT MODE MOSFET; PCH; SOT-363; PD-(0.3W); I-(0.13A); V-(-50V)
53	4	Q31, Q32, Q41, Q42	Pref	90-2N7002W-24	2N7002WT1G	ON SEMICONDUCTOR	2N7002WT1G	TRAN; SMALL SIGNAL MOSFET SINGLE N-CHANNEL; NCH; SC70; PD-(0.28W); I-(0.34A); V-(-60V)
54	3	R1, R7, R10	Pref	80-0100R-18	ERJ-2RKF1000	PANASONIC	100	RESISTOR; 0402; 100Ω; 1%; 100PPM; 0.10W; THICK FILM
55	4	R2, R4-R6	Pref	80-0000R-26A	ERJ-2GE0R00	PANASONIC	0	RESISTOR; 0402; 0Ω; 0%; 0%; JUMPER; 0.10W; THICK FILM
56	1	R3	Pref	80-024K9-18	ERJ-2RKF2492	PANASONIC	24.9K	RESISTOR; 0402; 24.9KΩ; 1%; 100PPM; 0.10W; THICK FILM
57	1	R8	Pref	80-0050R-DA53	Y162550R0000B9	VISHAY FOIL RESISTORS	50	RES; SMT (1206); 50; 0.1%; 0.2PPM/°C; 0.3W
58	5	R9, R207, R301-R303	Pref	80-0010K-23	CRCW040210K0FK; RC0402FR-07100KL	VISHAY DALE; YAGEO PHICOMP	10K	RESISTOR; 0402; 10K; 1%; 100PPM; 0.0625W; THICK FILM
59	8	R11-R18	Pref	80-04K75-AA58	MMA02040C4751F	VISHAY BEYSCHLAG	4.75K	RES; SMT; 4.75K; 1%; ±1.50PPM/°C; 0.4W
60	2	R19, R29	Pref	80-0500R-U7	PLT0805Z5000AS	VISHAY DALE	500	RESISTOR; 0805; 500 OHM; 0.05%; 5PPM; 0.25W; THIN FILM
61	11	R20-R26, R171, R175, R176, R201	Pref	80-001K3-18	ERJ-2RKF1301	PANASONIC	1.3K	RESISTOR; 0402; 1.3KΩ; 1%; 100PPM; 0.10W; THICK FILM
62	2	R27, R28	Pref	80-0100K-23	CRCW0402100KFK; RC0402FR-07100KL	VISHAY; YAGEO	100K	RESISTOR; 0402; 100K; 1%; 100PPM; 0.0625W; THICK FILM
63	3	R31, R32, R102	Pref	80-0022K-23	CRCW040222K0FK	VISHAY DALE	22K	RESISTOR; 0402; 22KΩ; 1%; 100PPM; 0.0625W; THICK FILM
64	1	R34	Pref	80-06K19-24	ERJ-3EKF6191	PANASONIC	6.19K	RESISTOR; 0603; 6.19KΩ; 1%; 100PPM; 0.10W; METAL FILM
65	2	R41, R162	Pref	80-0100K-18	ERJ-2RKF1003	PANASONIC	100K	RESISTOR; 0402; 100KΩ; 1%; 100PPM; 0.10W; THICK FILM
66	1	R42	Pref	80-0200R-22	CRCW1206200RFK	VISHAY DALE	200	RESISTOR; 1206; 200Ω; 1%; 100PPM; 1/4W; THICK FILM
67	4	R110, R120, R130, R140	Pref	80-016K2-AA23	ERJ-2RKF1622	PANASONIC	16.2K	RES; SMT (0402); 16.2K; 1%; ±100PPM/°C; 0.1W
68	4	R111, R121, R131, R141	Pref	80-0499K-23	CRCW0402499KFK	VISHAY DALE	499K	RESISTOR; 0402; 499K; 1%; 100PPM; 0.0625W; THICK FILM
69	2	R112, R122	Pref	80-026K1-AA4	CRCW060326K1FK	VISHAY DALE	26.1K	RESISTOR; 0603; 26.1KΩ; 1%; 100PPM; 0.1W; THICK FILM
70	5	R113, R123, R133, R143, R151	Pref	80-0000R-CA73	RC0201JR-070RL	YAGEO	0	RESISTOR; 0201; 0Ω; 0%; 0%; JUMPER; 0.05W; THICK FILM
71	2	R132, R142	Pref	80-0107K-18	ERJ-2RKF1073	PANASONIC	107K	RESISTOR; 0402; 107KΩ; 1%; 100PPM; 0.10W; THICK FILM
72	2	R134, R144	Pref	80-090K9-AA18	CRCW040290K9FK	VISHAY DALE	90.9K	RESISTOR; 0402; 90.9KΩ; 1%; 100PPM; 0.063W; THICK FILM
73	2	R135, R145	Pref	80-044K8-DA89	RT0402BRE0744K8L	YAGEO	44.8K	RES; SMT (0402); 44.8K; 0.1%; ±50PPM/°C; 0.063W
74	4	R136, R137, R146, R147	Pref	80-002K2-AA78	CRCW020122K1FK	VISHAY DALE	22.1K	RESISTOR; 0201; 22.1KΩ; 1%; 100PPM; 0.05W; THICK FILM
75	2	R148, R149	Pref	80-003K3-24	RCW06033K30FK; RC0603FR-073K3L; RK73H1J3301F	VISHAY; YAGEO; VISHAY	3.3K	RESISTOR; 0603; 3.3KΩ; 1%; 100PPM; 0.10W; THICK FILM
76	1	R150	Pref	80-069K8-18	ERJ-2RKF6982	PANASONIC	69.8K	RESISTOR; 0402; 69.8KΩ; 1%; 100PPM; 0.10W; THICK FILM
77	1	R152	Pref	80-022R1-AA23	ERJ-2RKF22R1	PANASONIC	22.1	RES; SMT (0402); 22.1; 1%; ±100PPM/°C; 0.10W

MAX22000 EV Kit Bill of Materials (continued)

ITEM	QTY	REF DES	VAR STATUS	MAXINV	MFG PART #	MANUFACTURER	VALUE	DESCRIPTION
78	1	R153	Pref	80-0162K-AA23	ERJ-2RKF1623	PANASONIC	162K	RESISTOR; 0402; 162KΩ; 1%; 100PPM; 0.1W; THICK FILM
79	1	R154	Pref	80-049K9-18A	ERJ-2RKF4992	PANASONIC	49.9K	RESISTOR; 0402; 49.9KΩ; 1%; 100PPM; 0.10W; THICK FILM
80	1	R161	Pref	80-0453K-18	ERJ-2RKF4533	PANASONIC	453K	RESISTOR; 0402; 453KΩ; 1%; 100PPM; 0.10W; THICK FILM
81	1	R170	Pref	80-0001R-24	ERJ-3RQF1R0; CRCW06031R00FK	PANASONIC;VISHAY	1	RESISTOR, 0603, 1Ω, 1%, 100PPM, 0.10W, THICK FILM
82	2	R191, R192	Pref	80-004K7-23	CRCW04024K70FK; MCR01MZPF4701	VISHAY DALE; ROHM SEMICONDUCTOR	4.7K	RESISTOR, 0402, 4.7KΩ, 1%, 100PPM, 0.0625W, THICK FILM
83	2	R202, R203	Pref	80-0010R-24	CRCW060310R0FK; MCR03EZPFX10R0; ERJ-3EKF10R0	VISHAY DALE; ROHM	10	RESISTOR; 0603; 10Ω; 1%; 100PPM; 0.10W; THICK FILM
84	1	R204	Pref	80-0010K-24	CRCW060310K0FK; ERJ-3EKF1002	VISHAY DALE; PANASONIC	10K	RESISTOR; 0603; 10K; 1%; 100PPM; 0.10W; THICK FILM
85	1	R205	Pref	80-0015K-24	CRCW060315K0FK	VISHAY DALE	15K	RESISTOR, 0603, 15KΩ, 1%, 100PPM, 0.10W, THICK FILM
86	1	R206	Pref	80-0012K-24	CRCW060312K0FK	VISHAY DALE	12K	RESISTOR, 0603, 12KΩ, 1%, 100PPM, 0.10W, THICK FILM
87	1	R208	Pref	80-002K2-23	CRCW04022K20FK; RC0402FR-072K2L	VISHAY DALE; YAGEO PHICOMP	2.2K	RESISTOR, 0402, 2.2KΩ, 1%, 100PPM, 0.0625W, THICK FILM
88	8	R209, R210, R214, R217, R220-R222, R230	Pref	80-0010K-95	CRCW020110K0FK	VISHAY DALE	10K	RESISTOR; 0201; 10KΩ; 1%; 100PPM; 0.05W; THICK FILM
89	1	R211	Pref	80-0665R-24	CRCW0603665RFK	VISHAY DALE	665	RESISTOR; 0603; 665Ω; 1%; 100PPM; 0.10W; THICK FILM
90	1	RP1	Pref	80-0100R-24	CRCW0603100RFK; ERJ-3EKF1000; RC0603FR-07100RL	VISHAY DALE; PANASONIC	100	RESISTOR; 0603; 100Ω; 1%; 100PPM; 0.10W; THICK FILM
91	1	RT1	Pref	85-0001K-0AH	32207638	HERAEUS SENSOR TECHNOLOGY	1K	RESISTANCE TEMPERATURE DETECTOR; SMT (0603); PLATINUM; 1KΩ; TOL = ±0.12%
92	1	R_CLIM	Pref	80-082K5-26	CRCW120682K5FK	VISHAY DALE	82.5K	RESISTOR; 1206; 82.5KΩ; 1%; 100PPM; 0.25W; THICK FILM
93	1	SW1	Pref	11-21912MST-00	219-12MST	CTS	219-12MST	SWITCH; SPST; SMT; STRAIGHT; 20V; 0.1A; SURFACE MOUNT DIP SWITCH-AUTO PLACEABLE; RINSULATION = 1000MΩ
94	16	TP4, TP6, TP8, TP9, TP11, TP14, TP16, TP18, TP20, TP21, TP30-TP35	Pref	02-TPCOMP5009-00	5009	KEYSTONE	N/A	TEST POINT; PIN DIA = 0.125IN; TOTAL LENGTH = 0.35IN; BOARD HOLE = 0.063IN; YELLOW; PHOSPHOR BRONZE WIRE SILVER PLATE FINISH; RECOMMENDED FOR BOARD THICKNESS = 0.062IN; NOT FOR COLD TEST
95	5	TP12, TP15, TP22, TP37, TP151	Pref	02-TPMULTI5127-00	5127	KEYSTONE	N/A	TEST POINT; PIN DIA=0.125IN; TOTAL LENGTH = 0.445IN; BOARD HOLE = 0.063IN; BLUE; PHOSPHOR BRONZE WIRE SILVER PLATE FINISH; RECOMMENDED FOR BOARD THICKNESS = 0.062IN; NOT FOR COLD TEST
96	1	TP101	Pref	02-TPMULTI5128-00	5128	KEYSTONE	N/A	TEST POINT; PIN DIA=0.125IN; TOTAL LENGTH = 0.445IN; BOARD HOLE = 0.063IN; GREY; PHOSPHOR BRONZE WIRE SILVER PLATE FINISH; RECOMMENDED FOR BOARD THICKNESS = 0.062IN; NOT FOR COLD TEST
97	1	TP103	Pref	02-TPMINI5010-00	5010	KEYSTONE	N/A	TEST POINT; PIN DIA = 0.125IN; TOTAL LENGTH = 0.445IN; BOARD HOLE = 0.063IN; RED; PHOSPHOR BRONZE WIRE SIL; NOT FOR COLD TEST
98	2	TP110, TP130	Pref	02-TPMINI5013-00	5013	KEYSTONE	N/A	TEST POINT; PIN DIA = 0.125IN; TOTAL LENGTH = 0.445IN; BOARD HOLE = 0.063IN; ORANGE; PHOSPHOR BRONZE WIRE SILVER PLATE FINISH; RECOMMENDED FOR BOARD THICKNESS = 0.062IN; NOT FOR COLD TEST

MAX22000 EV Kit Bill of Materials (continued)

ITEM	QTY	REF DES	VAR STATUS	MAXINV	MFG PART #	MANUFACTURER	VALUE	DESCRIPTION
99	2	TP120, TP140	Pref	02-TPMULTI5126-00	5126	KEystone	N/A	TEST POINT; PIN DIA = 0.125IN; TOTAL LENGTH = 0.445IN; BOARD HOLE = 0.063IN; GREEN; PHOSPHOR BRONZE WIRE SILVER PLATE FINISH; RECOMMENDED FOR BOARD THICKNESS = 0.062IN; NOT FOR COLD TEST
100	1	TP150	Pref	02-TPMINI5125-00	5125	KEystone	N/A	TEST POINT; PIN DIA = 0.125IN; TOTAL LENGTH = 0.445IN; BOARD HOLE = 0.063IN; BROWN; PHOSPHOR BRONZE WIRE SILVER PLATE FINISH; RECOMMENDED FOR BOARD THICKNESS = 0.062IN; NOT FOR COLD TEST
101	1	U1	Pref	00-SAMPLE-02	MAX22000	MAXIM	MAX22000	EVKIT PART - IC; MAX22000; 9.5X9X1.1 MM; 0.5MM PITCH; LGA64-5EP; PACKAGE OUTLINE NUMBER: 90-100096
102	1	U2	Pref	10-MAX4690EAE-A	MAX4690EAE+	MAXIM	MAX4690EAE+	IC; ASW; 1.250HM; DUAL SPST; CMOS ANALOG SWITCHES; SSOP16
103	4	U10, U20, U30, U40	Pref	10-MAX15062CATA-T	MAX15062CATA+	MAXIM	MAX15062CATA+	IC; CONV; ULTRA-SMALL; HIGH EFFICIENCY; SYNCHRONOUS STEP-DOWN DC-DC CONVERTER; TDFN8
104	1	U50	Pref	10-MAX17552ATB-T	MAX17552ATB+	MAXIM	MAX17552ATB+	IC; CONV; ULTRA-SMALL; HIGH-EFFICIENCY; SYNCHRONOUS STEP-DOWN DC-DC CONVERTER; TDFN10-EP
105	1	U60	Pref	10-MAX8902BATA-T	MAX8902BATA+	MAXIM	MAX8902BATA+	IC; VREG; LOW-NOISE LDO REGULATOR; TDFN8 2X2
106	1	U80	Pref	10-MAX6126AASA25-S	MAX6126AASA25+	MAXIM	MAX6126AASA25+	IC; VREF; ULTRA HIGH PRECISION; ULTRA LOW NOISE VOLTAGE REFERENCE; SOIC8 150MIL; VOUT = 2.5V, 3PPM/C MAX TEMPCO; NSOIC8
107	2	U201, U202	Pref	10-MAX14483AAP-A	MAX14483AAP+	MAXIM	MAX14483AAP+	IC; DISO; 6-CHANNEL; LOW-POWER; 3.75KV RMS SPI DIGITAL ISOLATOR; SSOP20
108	1	U203	Pref	10-FT2232HQ-G	FT2232HQ	FUTURE TECHNOLOGY DEVICES INTL LTD.	FT2232HQ	IC; MMR; DUAL HIGH SPEED USB TO MULTIPURPOSE UART/FIFO; QFN64-EP
109	1	U204	Pref	10-93LC66BTIOT-U	93LC66BT-I/OT	MICROCHIP	93LC66BT-I/OT	IC; EPROM; 4K MICROWIRE SERIAL EEPROM; SOT23-6
110	1	U205	Pref	10-MAX1556ETB-T	MAX1556ETB+	MAXIM	MAX1556ETB+	IC; CONV; PWM STEP-DOWN DC-DC CONVERTER; TDFN10-EP 3X3
111	1	U206	Pref	10-M25P16VMN6P-S	M25P16-VMN6P	MICRON TECHNOLOGY INC.	M25P16-VMN6P	IC; MMR; 16MBIT; SERIAL FLASH MEMORY; 75MHZ SPI BUS INTERFACE; NSOIC8 150MIL
112	1	Y1	Pref	60-0012M-19	ABM7-12.000MHZ-D2Y-T	ABRACON	12MHZ	CRYSTAL; SMT ; 18PF; 12MHZ; ±20PPM; ±30PPM
113	1	PCB	-	EPCB22000	MAX22000	MAXIM	PCB	PCB:MAX22000
TOTAL	318							

DO NOT PURCHASE(DNP)								
ITEM	QTY	REF DES	VAR STATUS	MAXINV	MFG PART #	MANUFACTURER	VALUE	DESCRIPTION
1	1	C14	DNP	20-00U01-11	GRM188R71C103KA01; ECJ-1VB1C10; CL10B103K08NNN; GCJ188R71C103KA01	MURATA; PANASONIC; SAMSUNG; MURATA	0.01UF	CAPACITOR; SMT (0603); CERAMIC CHIP; 0.01µF; 16V; TOL = 10%; TG = -55°C TO +125°C; TC = X7R
2	1	R33	DNP	80-0000R-26A	ERJ-2GE0R00	PANASONIC	0	RESISTOR; 0402; 0Ω; 0%; JUMPER; 0.10W; THICK FILM
3	1	R30	DNP	N/A	N/A	N/A	SHORT	PACKAGE OUTLINE 0402 RESISTOR - EVKIT
TOTAL	3							

PACKOUT (These are purchased parts but not assembled on PCB and will be shipped with PCB)								
ITEM	QTY	REF DES	VAR STATUS	MAXINV	MFG PART #	MANUFACTURER	VALUE	DESCRIPTION
TOTAL	0							

MAX22000 EV Kit Schematic

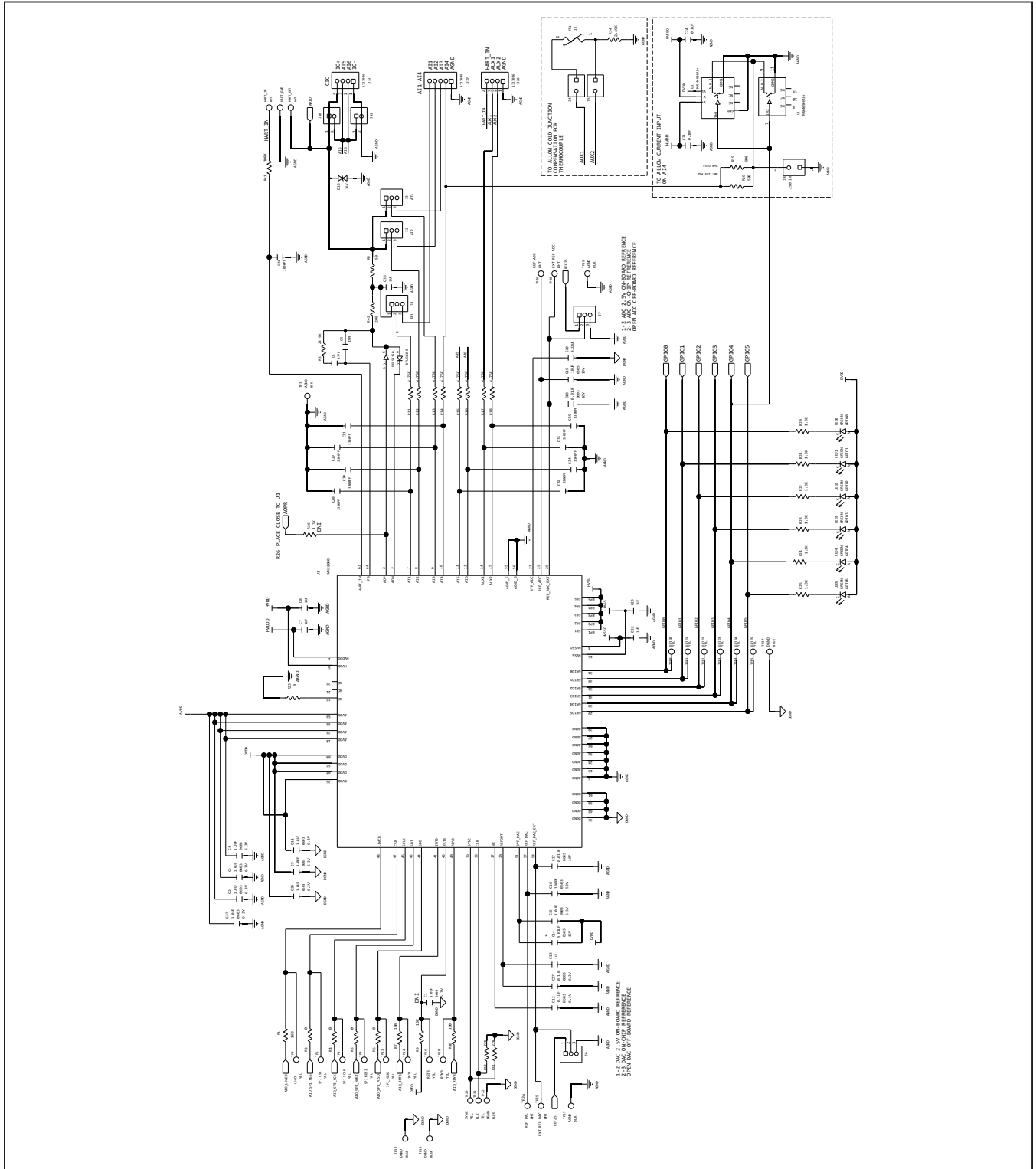

MAX22000 EV Kit Schematic (continued)

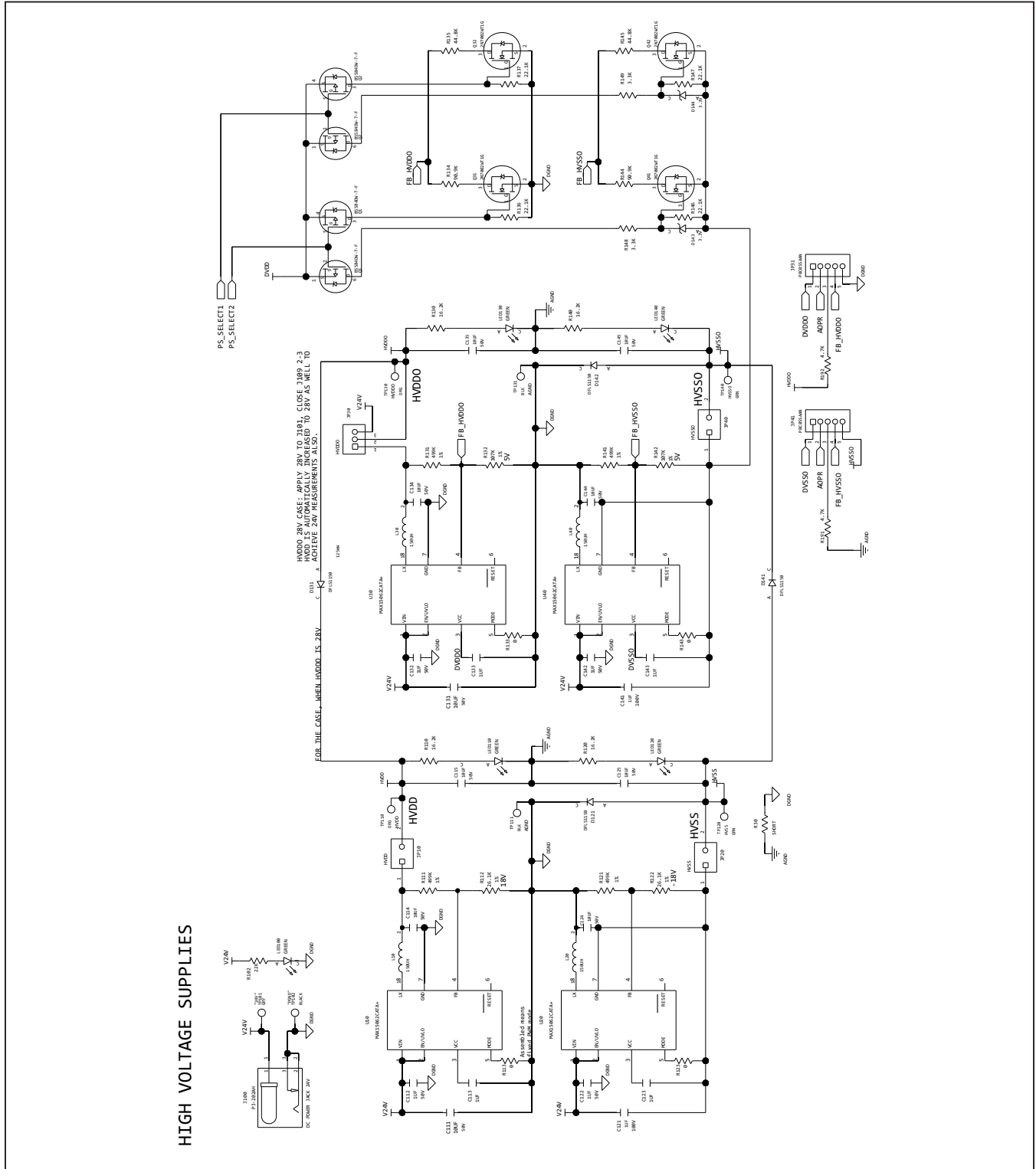

MAX22000 EV Kit Schematic (continued)

DIGITAL IO

LOW VOLTAGE SUPPLIES

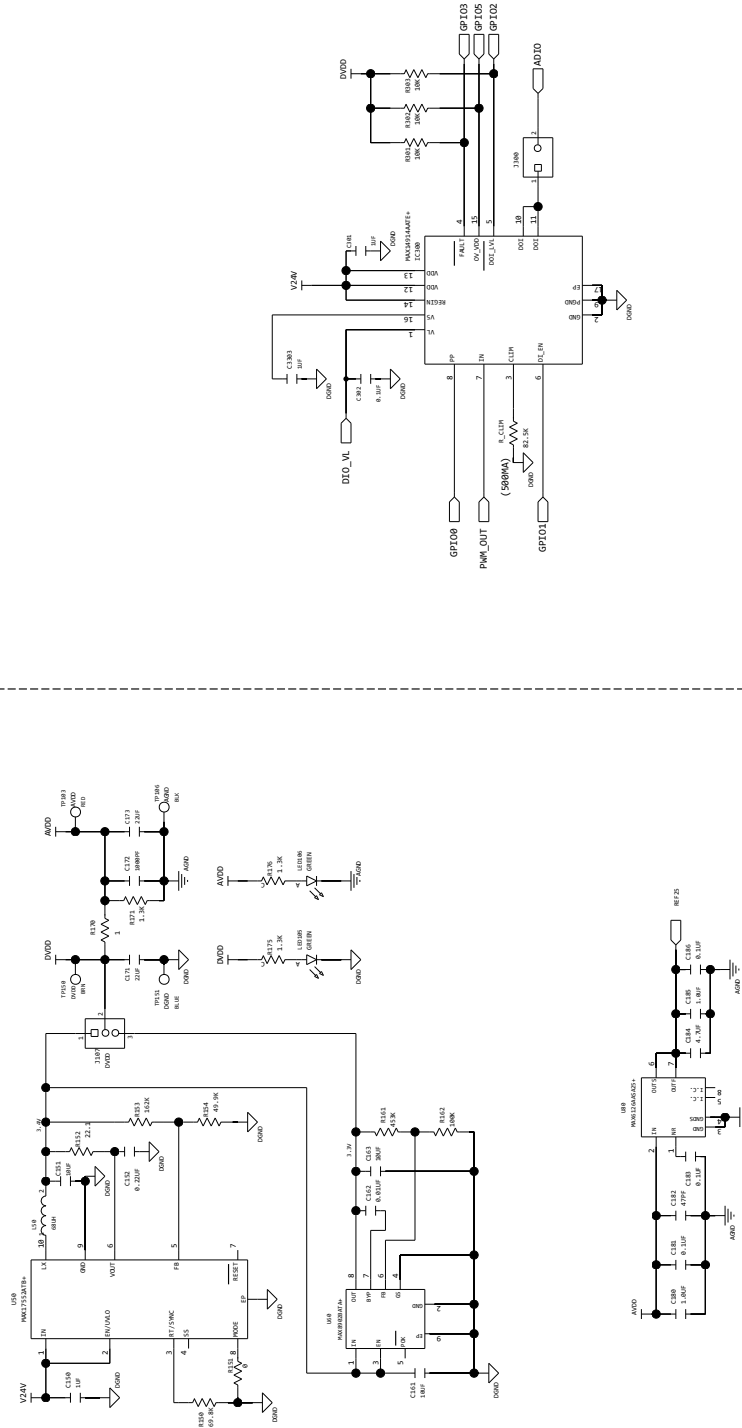

MAX22000 EV Kit Schematic (continued)

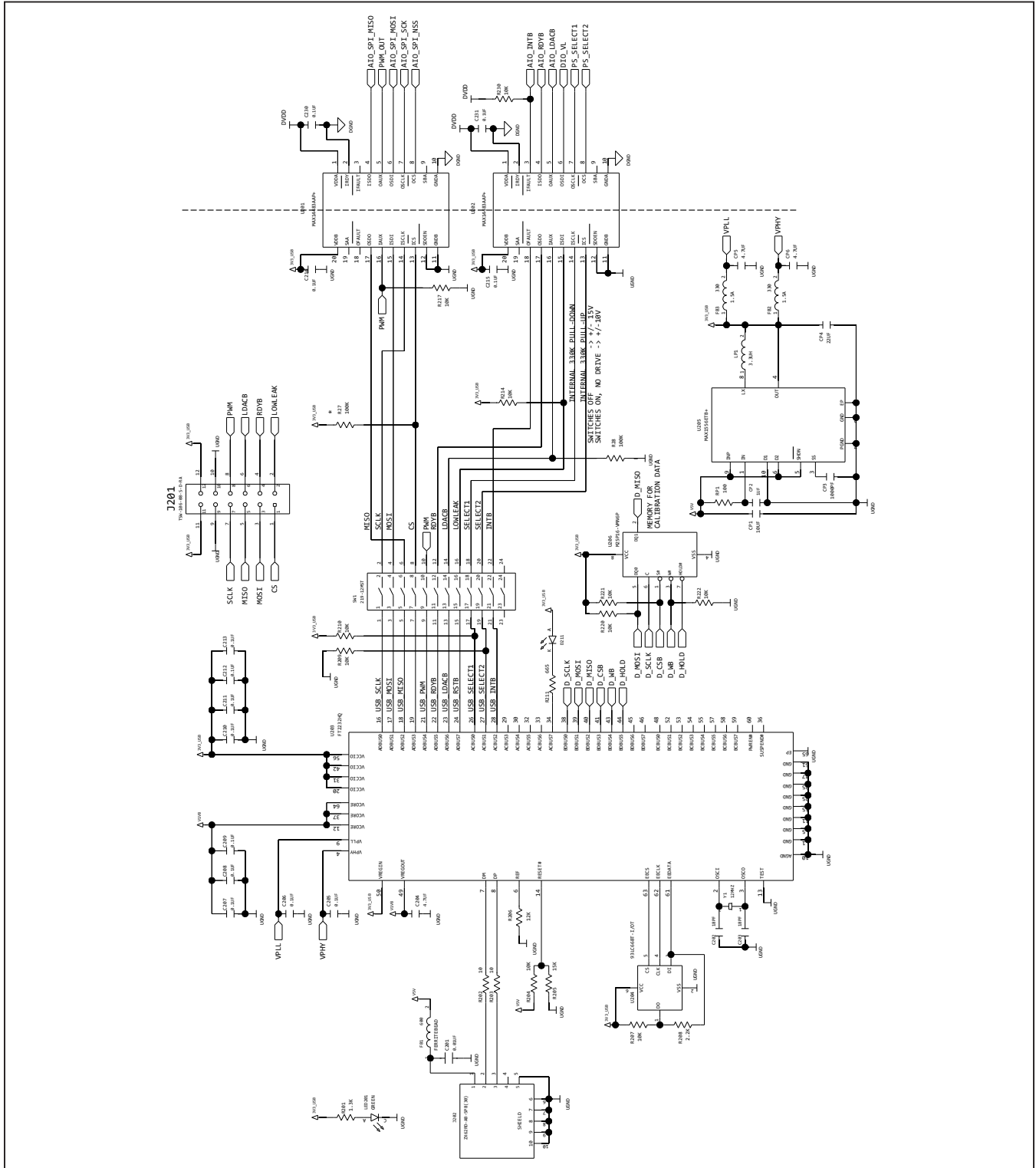

MAX22000E EV Kit PCB Layout Diagrams

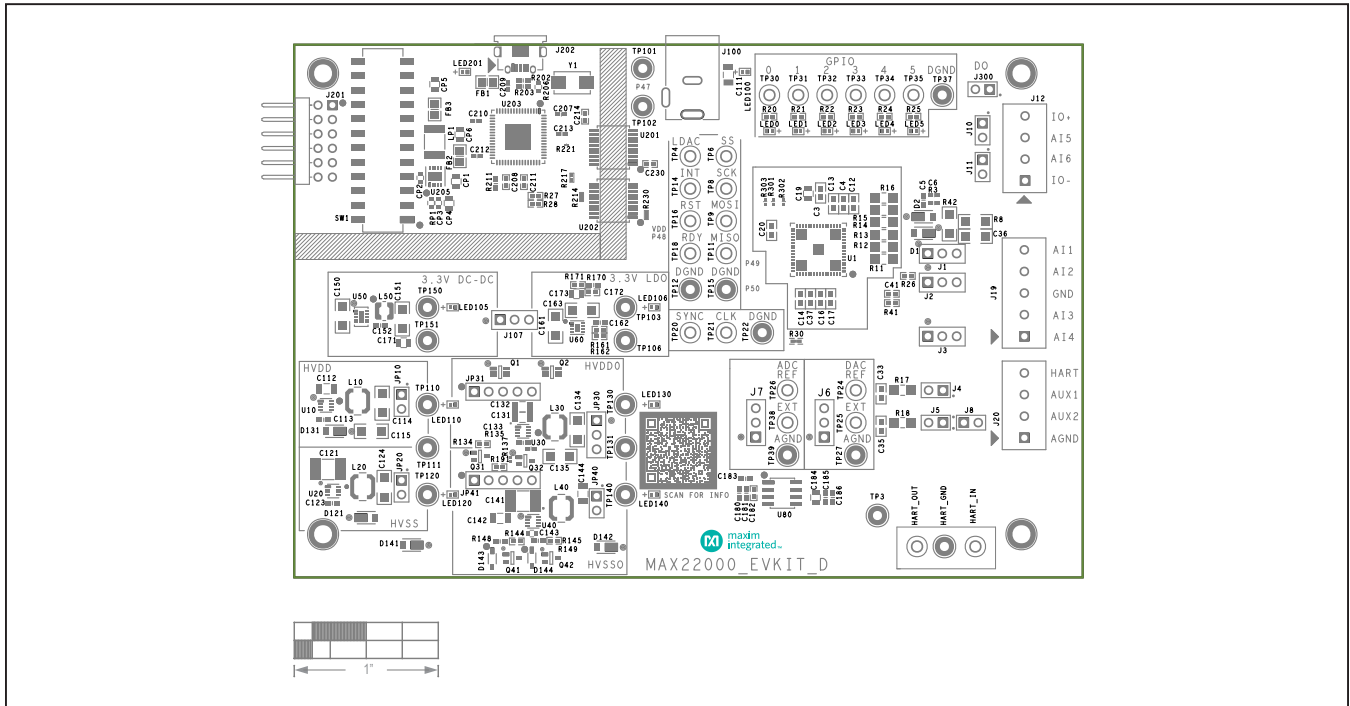

MAX22000 EV Kit—Top Silkscreen

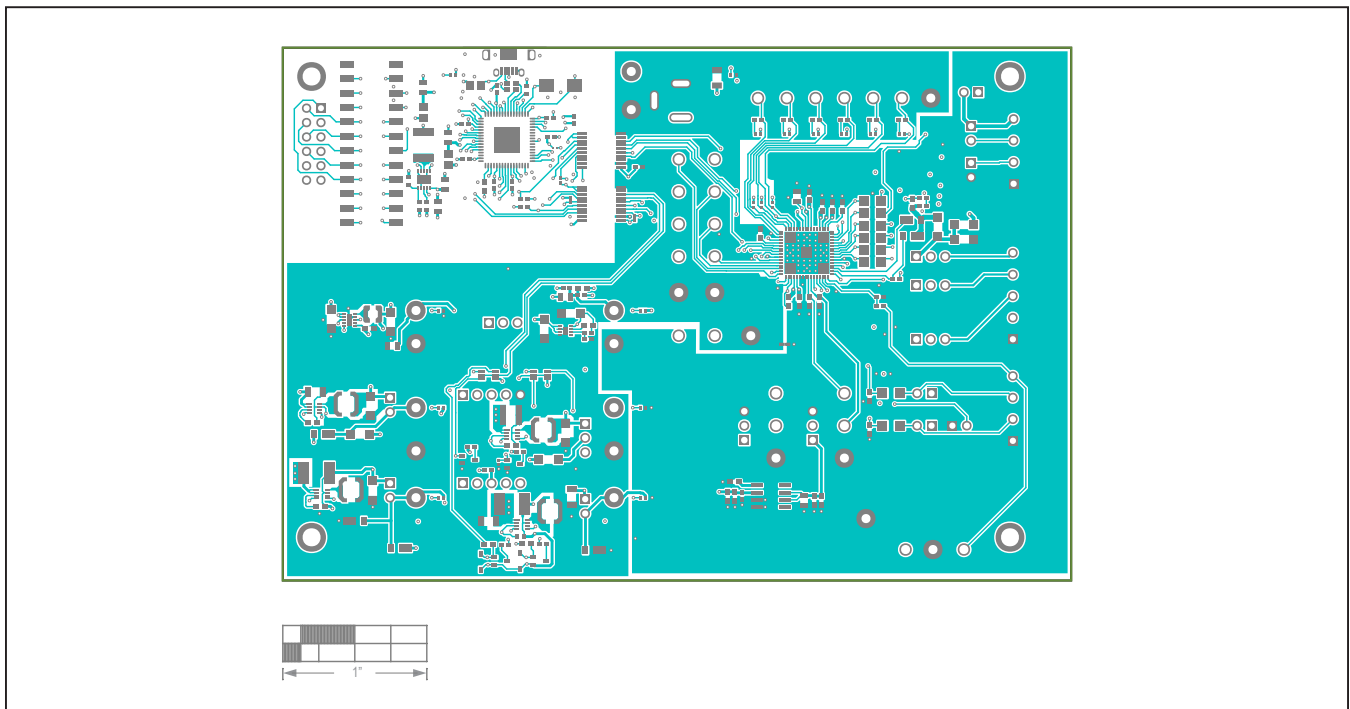

MAX22000 EV Kit—Top Layer

MAX22000 EV Kit PCB Layout Diagrams (continued)

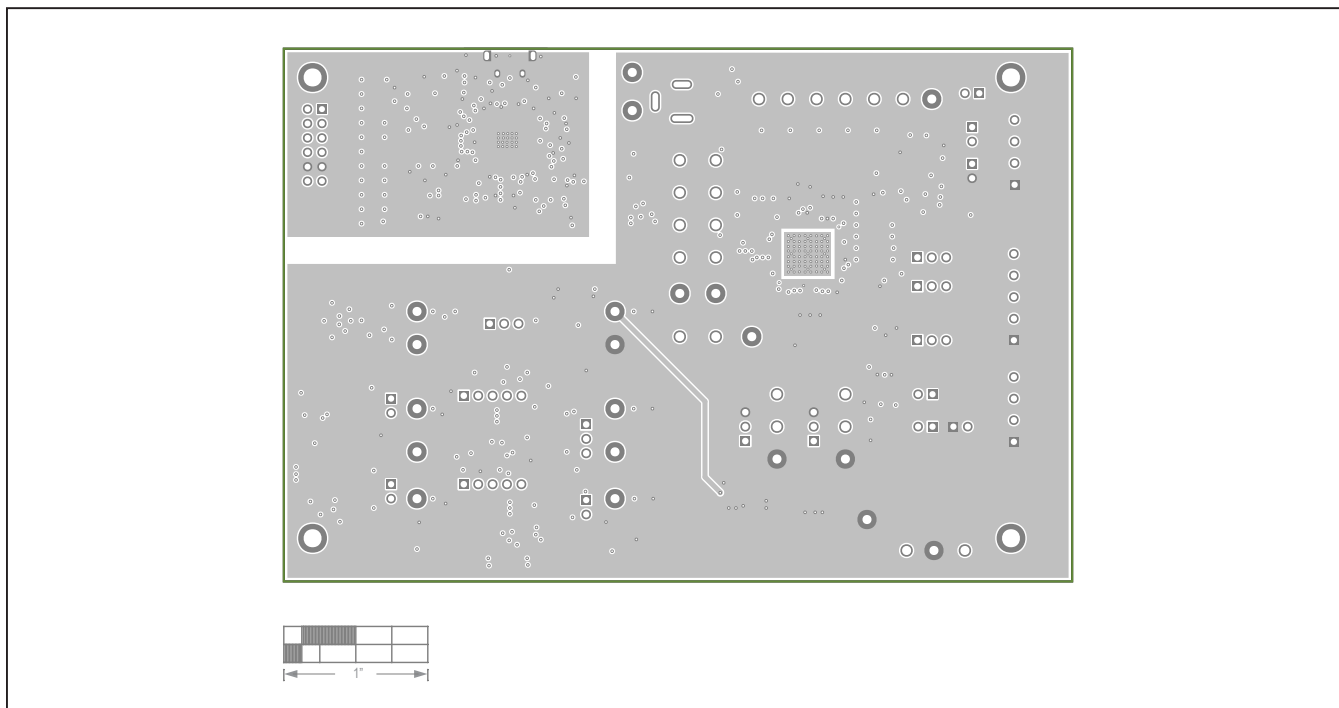

MAX22000 EV Kit—Layer 2

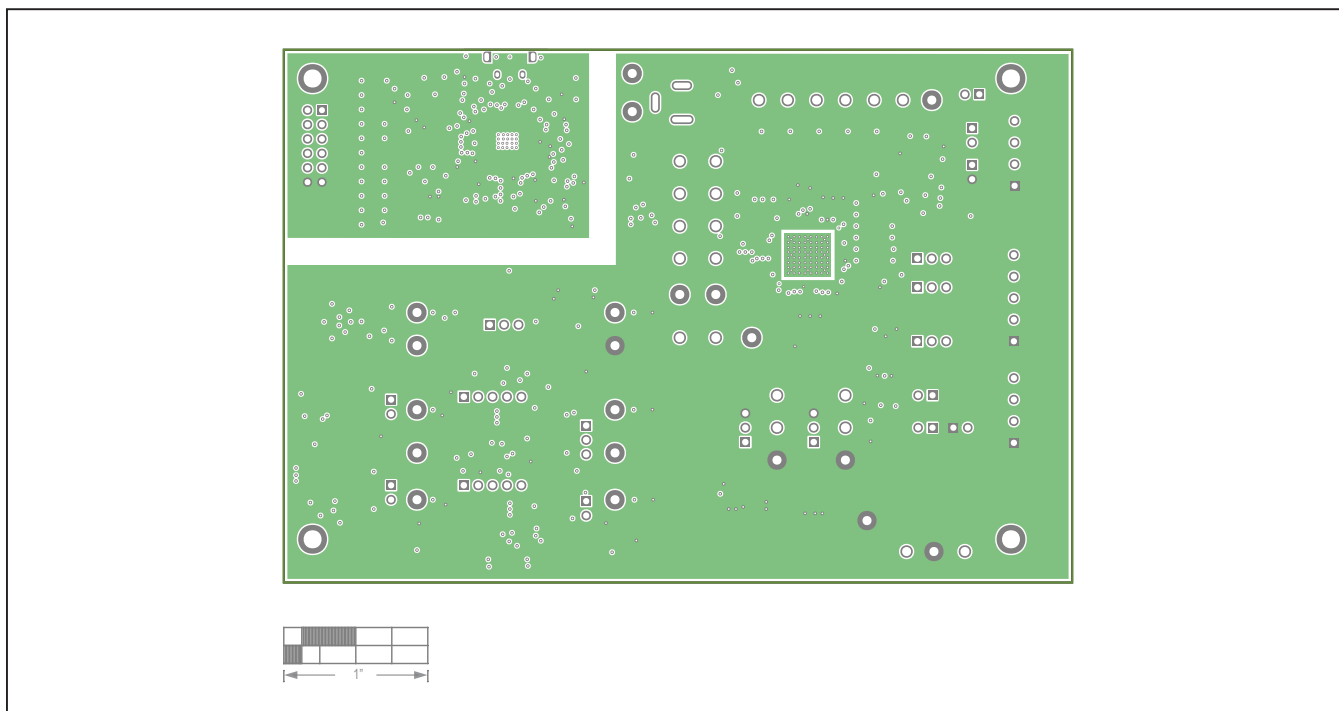

MAX22000 EV Kit—Layer 3

MAX22000 EV Kit PCB Layout Diagrams (continued)

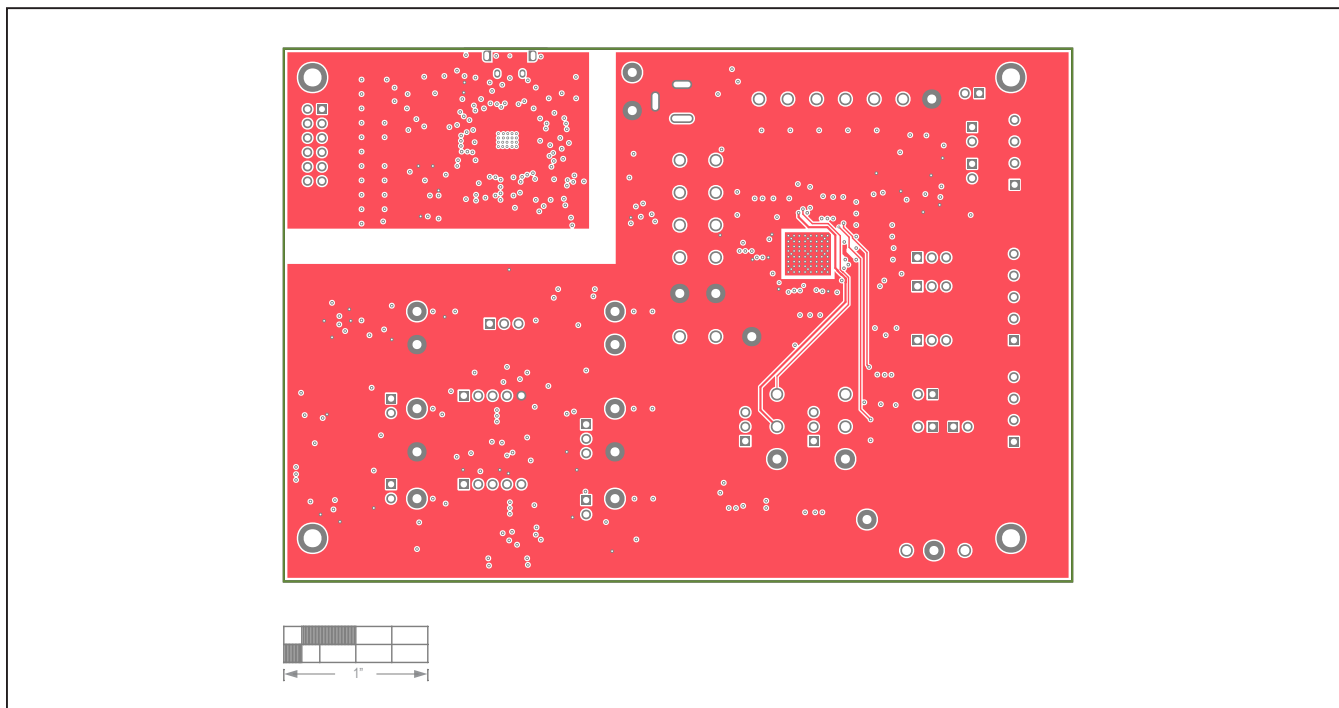

MAX22000 EV Kit—Layer 4

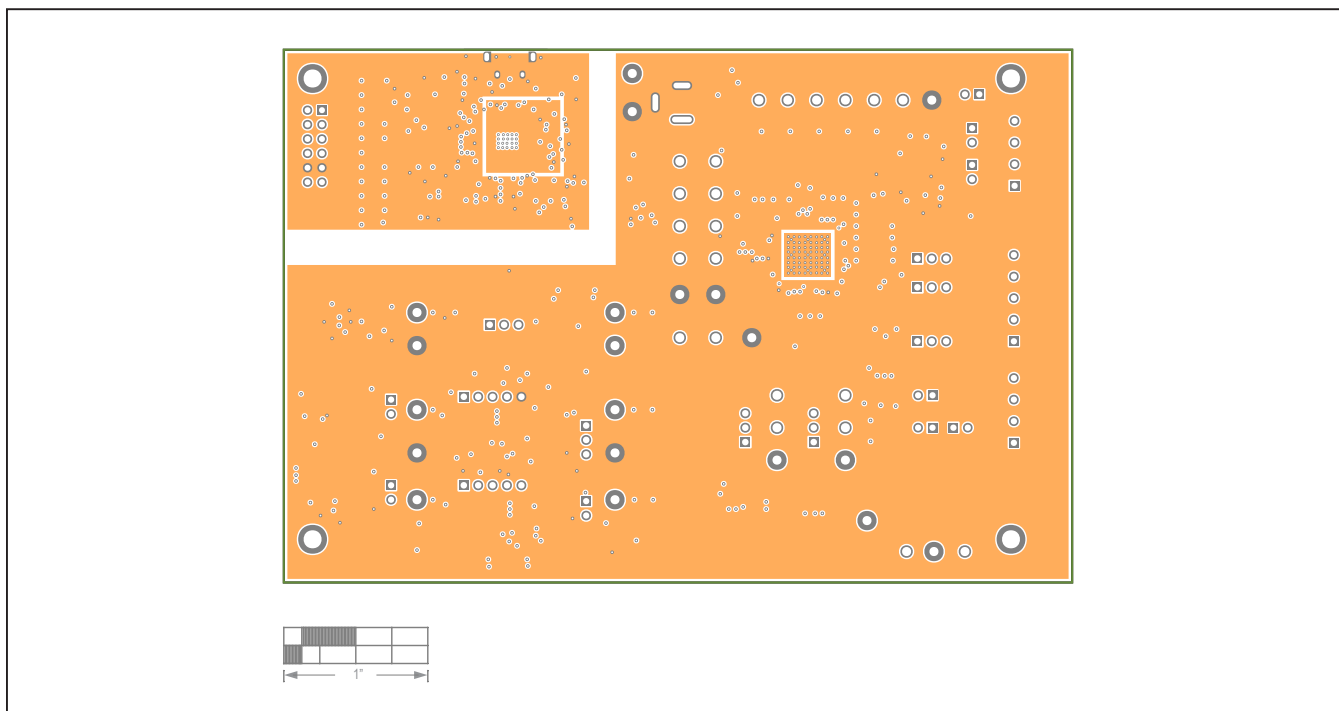

MAX22000 EV Kit—Layer 5

MAX22000 EV Kit PCB Layout Diagrams (continued)

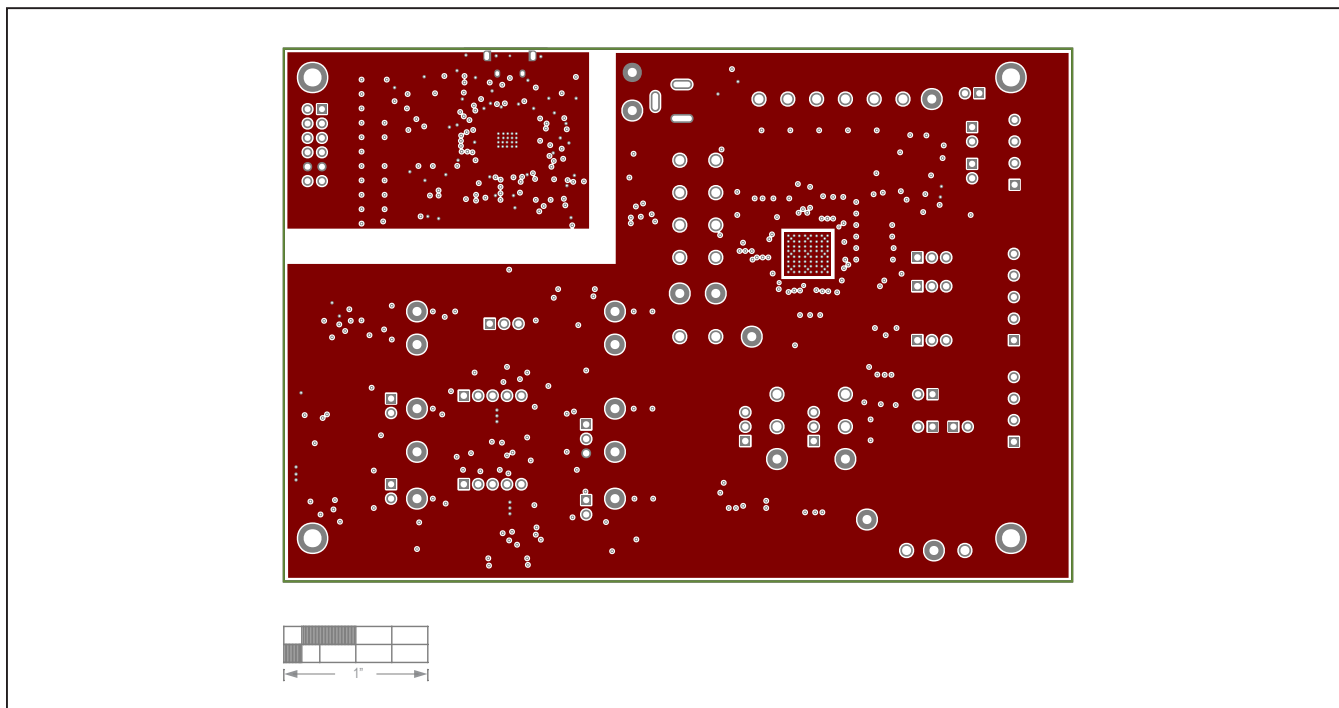

MAX22000 EV Kit—Layer 6

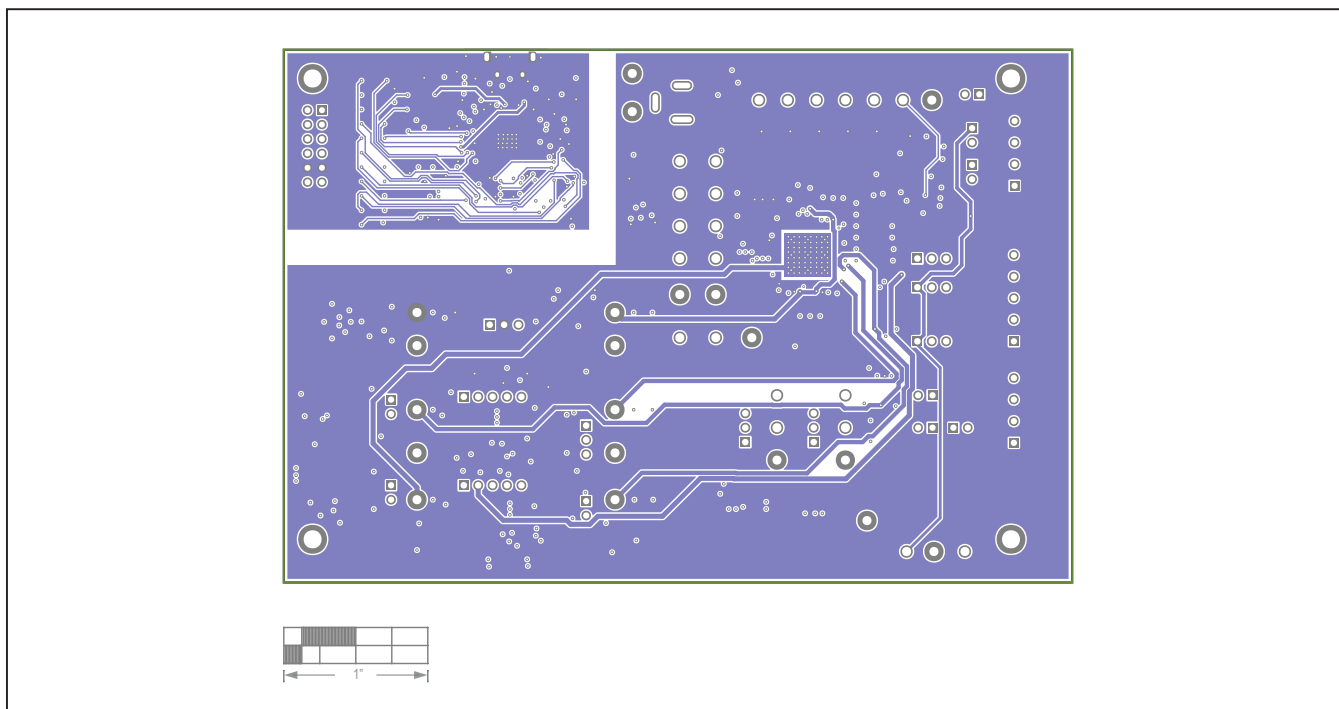

MAX22000 EV Kit—Layer 7

MAX22000 EV Kit PCB Layout Diagrams (continued)

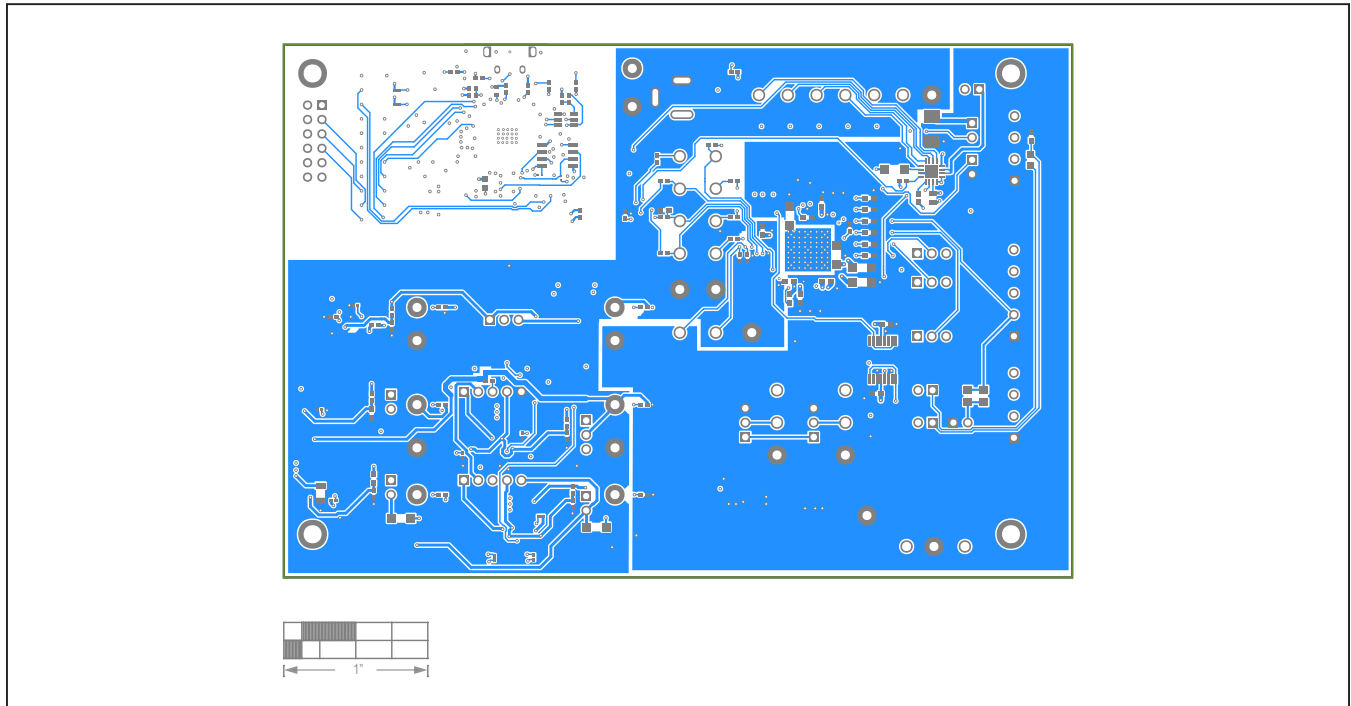

MAX22000 EV Kit—Bottom Layer

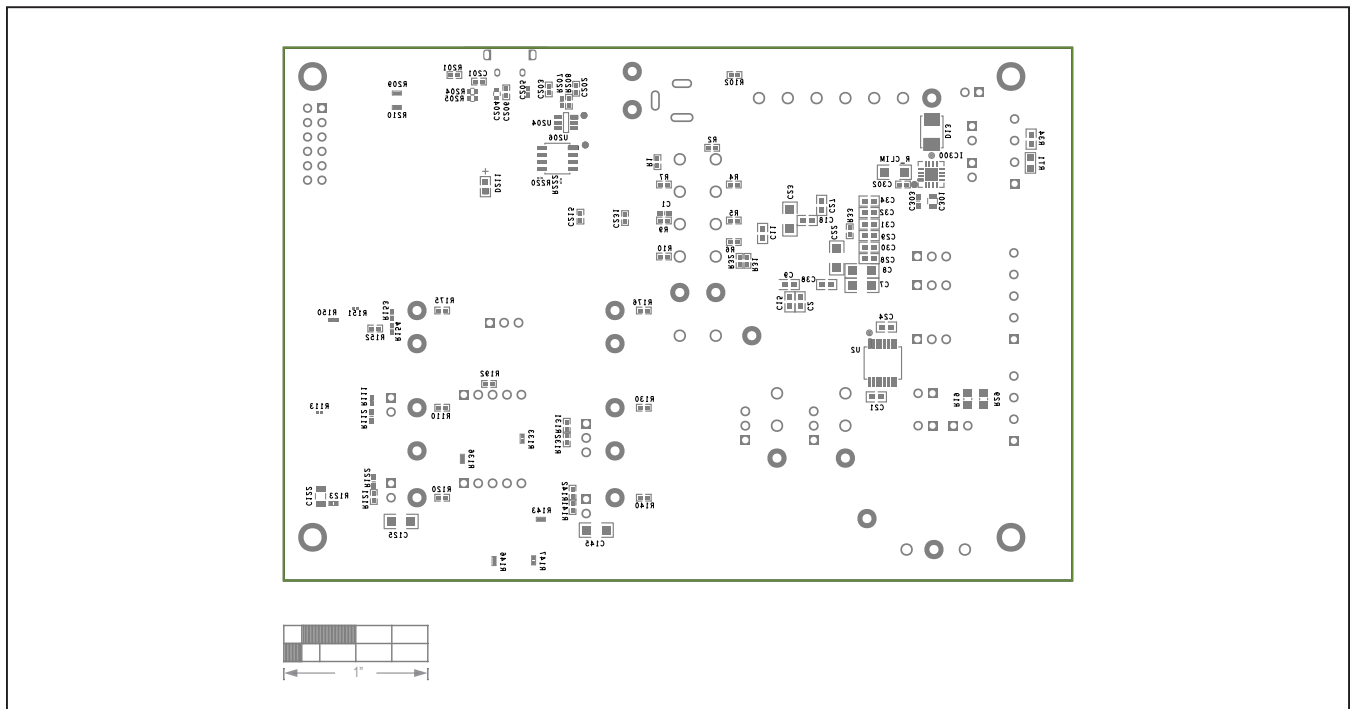

MAX22000 EV Kit—Bottom Silkscreen

Revision History

REVISION NUMBER	REVISION DATE	DESCRIPTION	PAGES CHANGED
0	5/20	Initial release	—

For pricing, delivery, and ordering information, please visit Maxim Integrated's online storefront at <https://www.maximintegrated.com/en/storefront/storefront.html>.

Maxim Integrated cannot assume responsibility for use of any circuitry other than circuitry entirely embodied in a Maxim Integrated product. No circuit patent licenses are implied. Maxim Integrated reserves the right to change the circuitry and specifications without notice at any time.