

SERIES: VOF-200C | DESCRIPTION: AC-DC POWER SUPPLY
FEATURES

- universal input voltage (85 ~ 264 Vac)
- active power factor correction
- certified to 62368, 60335, and 61558 safety standards
- suitable for safety class I or class II installations
- over voltage, over current, over temperature, and short circuit protections
- adjustable output via trim POT
- low leakage current (< 0.1 mA)
- low standby power consumption (0.5 W)

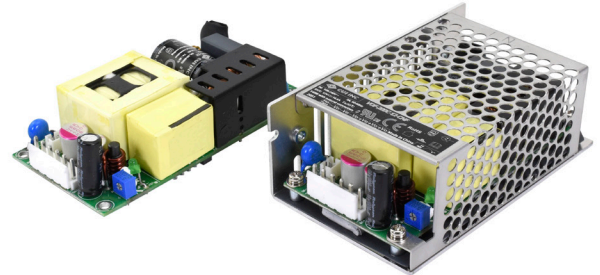

| MODEL | output voltage | output current | output power | ripple and noise ² | efficiency ³ | |
|-------------|----------------|-----------------------------|--------------|-------------------------------|-------------------------|------------|
| | (Vdc) | range ¹ (Vdc) | max (A) | max (W) | max (mVp-p) | typ (%) |
| VOF-200C-12 | 12 | 11.8~12.6 | 16.6 | 200 | 60 | 93 |
| VOF-200C-15 | 15 | 14.7~15.8 | 13.3 | 200 | 100 | 93 |
| VOF-200C-24 | 24 | 23.5~25.2 | 8.33 | 200 | 100 | 94 |
| VOF-200C-27 | 27 | 26.5~28.4 | 7.40 | 200 | 100 | 94 |
| VOF-200C-36 | 36 | 35.28~37.8 | 5.56 | 200 | 100 | 94 |
| VOF-200C-48 | 48 | 47.1~50.4 | 4.16 | 200 | 100 | 94 |

Notes:

1. When adjusting the output voltage care should be taken never to exceed the stated output power or output current of the unit.
2. At full load, nominal input, 20 MHz bandwidth oscilloscope, tip & barrel method, output terminated with 10 μ F electrolytic and 0.1 μ F ceramic capacitors. Under light load conditions (<15%) the measurement may double in an effort to maximize converter efficiency.
3. At 230 Vac.

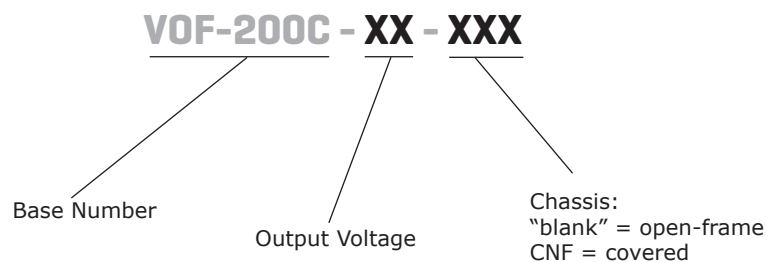
PART NUMBER KEY

INPUT

| parameter | conditions/description | min | typ | max | units |
|---------------------------|------------------------|------|-----|-----|-------|
| voltage | ac input | 85 | | 264 | Vac |
| | dc input | 120 | | 370 | Vdc |
| frequency | | 47 | | 63 | Hz |
| current | at 115 Vac | | | 3.0 | A |
| | at 230 Vac | | | 2.0 | A |
| inrush current | at 115 Vac, cold start | | 40 | | A |
| | at 230 Vac, cold start | | 75 | | A |
| leakage current | at 240 Vac | | | 0.1 | mA |
| power factor correction | at 115 Vac, full load | 0.99 | | | |
| | at 230 Vac, full load | 0.95 | | | |
| no load power consumption | | | 0.5 | | W |

OUTPUT

| parameter | conditions/description | min | typ | max | units |
|----------------------------|------------------------------|------|-------|-------|-------|
| output capacitance | 12 Vdc output model | | | 6,000 | μF |
| | 15 Vdc output model | | | 5,000 | μF |
| | 24 Vdc output model | | | 3,200 | μF |
| | 27 Vdc output model | | | 2,400 | μF |
| | 36 Vdc output model | | | 2,000 | μF |
| | 48 Vdc output model | | | 1,600 | μF |
| initial set point accuracy | full load | | ±1 | | % |
| line regulation | rated load | | ±0.5 | | % |
| load regulation | 0 ~ 100% load | | ±0.5 | | % |
| hold-up time | at 230 Vac, 25°C | | 12 | | ms |
| temperature coefficient | | | ±0.03 | | %/°C |
| fan power ¹ | 15 Vdc output models, 6W max | 20.4 | 24 | 27.6 | V |
| | other output models, 6W max | 10.2 | 12 | 13.8 | V |

Note: 1. With output voltage accuracy ±15%.

PROTECTIONS

| parameter | conditions/description | min | typ | max | units |
|-----------------------------|-----------------------------------|-----|-----|-----|-------|
| over voltage protection | output shutdown, latching | | | | |
| | 12 Vdc output model | | 16 | | Vdc |
| | 15 Vdc output model | | 20 | | Vdc |
| | 24 Vdc output model | | 32 | | Vdc |
| | 27 Vdc output model | | 35 | | Vdc |
| | 36 Vdc output model | | 50 | | Vdc |
| 48 Vdc output model | | 60 | | Vdc | |
| over current protection | hiccup, auto recovery | 110 | | | % |
| short circuit protection | continuous, auto recovery, hiccup | | | | |
| over temperature protection | output shutdown, auto recovery | | | | |

SAFETY & COMPLIANCE

| parameter | conditions/description | min | typ | max | units |
|----------------------------------|---|---------|-----|-----|-------|
| isolation voltage | input to ground for 1 minute, <10 mA | 1,500 | | | Vac |
| | input to output for 1 minute, <10 mA | 4,000 | | | Vac |
| | output to ground for 1 minute, <10 mA | 1,500 | | | Vac |
| safety approvals | certified to 62368: UL, EN (the VOF-200C-36 model does not have UL certification) certified to 60335: EN certified to 61558: EN | | | | |
| safety class | class I (with PE), class II (without PE) | | | | |
| conducted emissions ¹ | CISPR32/EN55032 CLASS B | | | | |
| radiated emissions ¹ | CISPR32/EN55032 (Class B for safety class I installations; Class A for safety class II installations) | | | | |
| harmonic current | IEC/EN61000-3-2 CLASS D | | | | |
| ESD | IEC/EN61000-4-2 Contact ±8KV/Air ±15KV perf. Criteria A | | | | |
| radiated immunity | IEC/EN61000-4-3 10V/m perf. Criteria A | | | | |
| EFT/burst | IEC/EN61000-4-4 ±4KV perf. Criteria A | | | | |
| surge | IEC/EN61000-4-5 ±2KV/±4KV perf. Criteria A | | | | |
| conducted immunity | IEC/EN61000-4-6 10 Vr.m.s perf. Criteria A | | | | |
| voltage dips and interruptions | IEC/EN61000-4-11 0%, 70% perf. Criteria B | | | | |
| MTBF | as per MIL-HDBK-217F, at 25°C | 300,000 | | | hours |
| RoHS | yes | | | | |

Notes: 1. The power supply is considered a component of the end system. All EMC performance has been tested on a metal plate with the dimensions 360 x 360 x 1 mm. The power supply must be integrated into the end system for proper electromagnetic compatibility testing.

ENVIRONMENTAL

| parameter | conditions/description | min | typ | max | units |
|-----------------------|------------------------|-----|-----|-----|-------|
| operating temperature | see derating curves | -40 | | 70 | °C |
| storage temperature | | -40 | | 85 | °C |
| operating humidity | non-condensing | 20 | | 90 | % |
| storage humidity | non-condensing | 10 | | 95 | % |

DERATING CURVES

**TEMPERATURE DERATING CURVE
(open-frame versions)**

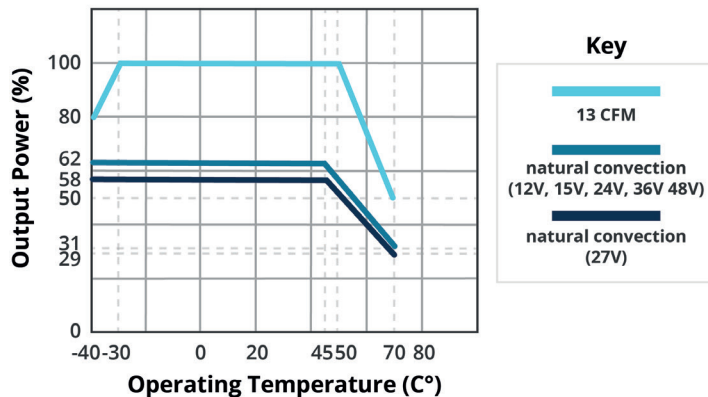

**TEMPERATURE DERATING CURVE
(-CNF versions)**

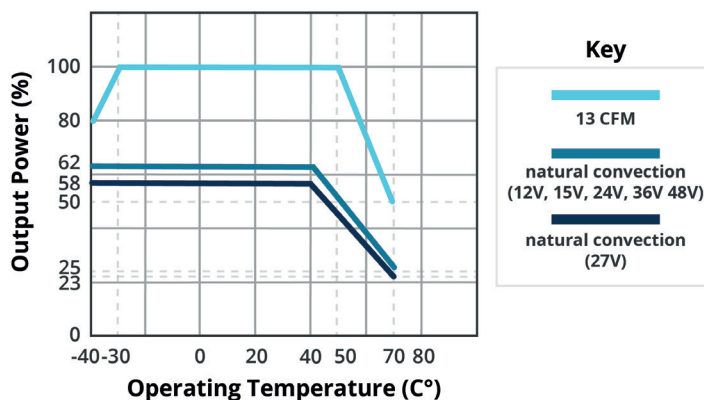

**INPUT VOLTAGE DERATING CURVE
(25°C)**

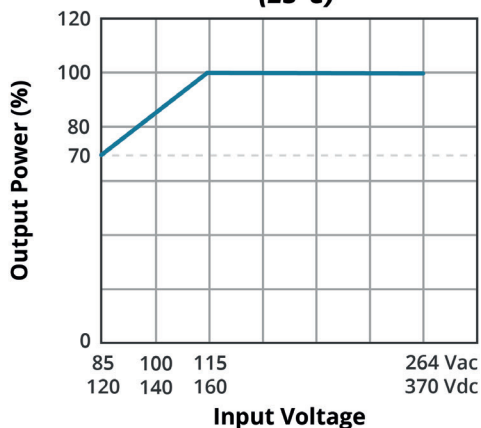

Note: With an AC input voltage between 85 ~ 115 and a DC input between 120 ~ 160 Vdc the output power must be derated as per the temperature derating curve.

EFFICIENCY CURVES

**EFFICIENCY VS INPUT VOLTAGE
(full load)**

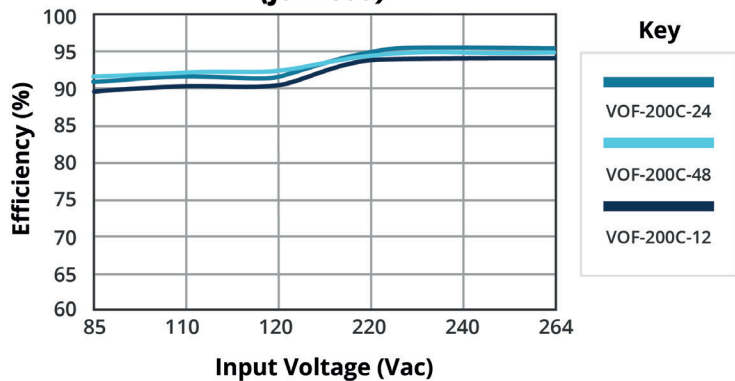

**EFFICIENCY VS OUTPUT LOAD
(Vin = 230 Vac)**

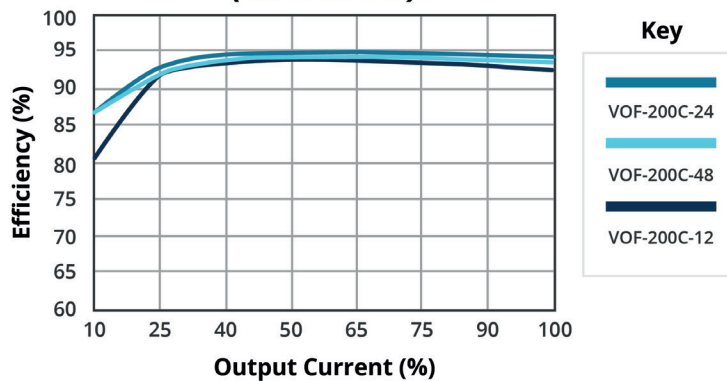

MECHANICAL

| parameter | conditions/description | min | typ | max | units |
|------------|---|-----|------------|-----|----------|
| dimensions | open frame models: 101.6 × 50.8 × 25.4 [4.0 × 2.0 × 1.0 inch] covered models: 103.4 × 62.0 × 37.0 [4.070 × 2.440 × 1.456 inch] | | | | mm mm |
| weight | open frame models covered models | | 175 260 | | g g |
| cooling | natural convection (no integrated fan) | | | | |

MECHANICAL DRAWING

Open-frame

units: mm [inch]

general tolerance: ±1.00 [±0.039]

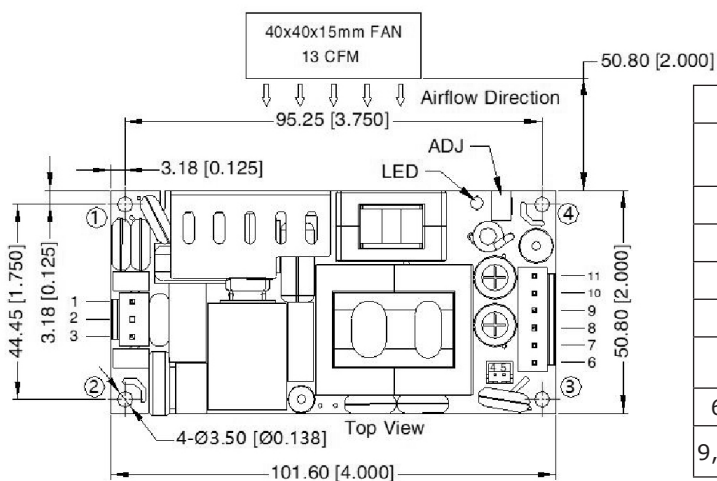

| PIN-OUT | | | |
|---------|------------|------------------------------|---|
| PIN | Function | Product Connector | Customer Connector |
| 1 | AC (N)/DC- | JST B3P-VH or equivalent | Housing: JST VHR Contact: JST SVH-21T-P1.1 or equivalent |
| 2 | NC | | |
| 3 | AC (L)/DC+ | JST B2B-PH-K-S or equivalent | Housing: JST PHR-2 Contact: JST SPH-002T-P0.5S or equivalent |
| 4 | Fan- | | |
| 5 | Fan+ | JST B6P-VH or equivalent | Housing: JST VHR Contact: JST SVH-21T-P1.1 or equivalent |
| 6,7,8 | -Vo | | |
| 9,10,11 | +Vo | | |

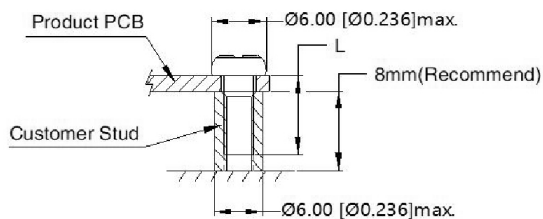
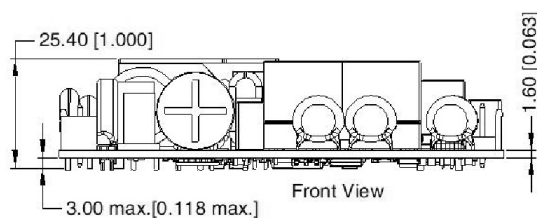

| Position | Screw Spec. | L (recommended) | Torque |
|----------|-------------|-----------------|---------|
| ①~④ | M3 | 6mm | 0.4 N·m |

Note: 1. Class I system ①, ③ positions must be connected to the protective earth ground (⊥).
2. Class II system ①, ③ positions must be connected together.
3. It is recommended that a minimum distance of 10mm be placed between the PCB edge and all other components.

MECHANICAL DRAWING (CONTINUED)

Covered

units: mm [inch]

general tolerance: ±1.00 [±0.039]

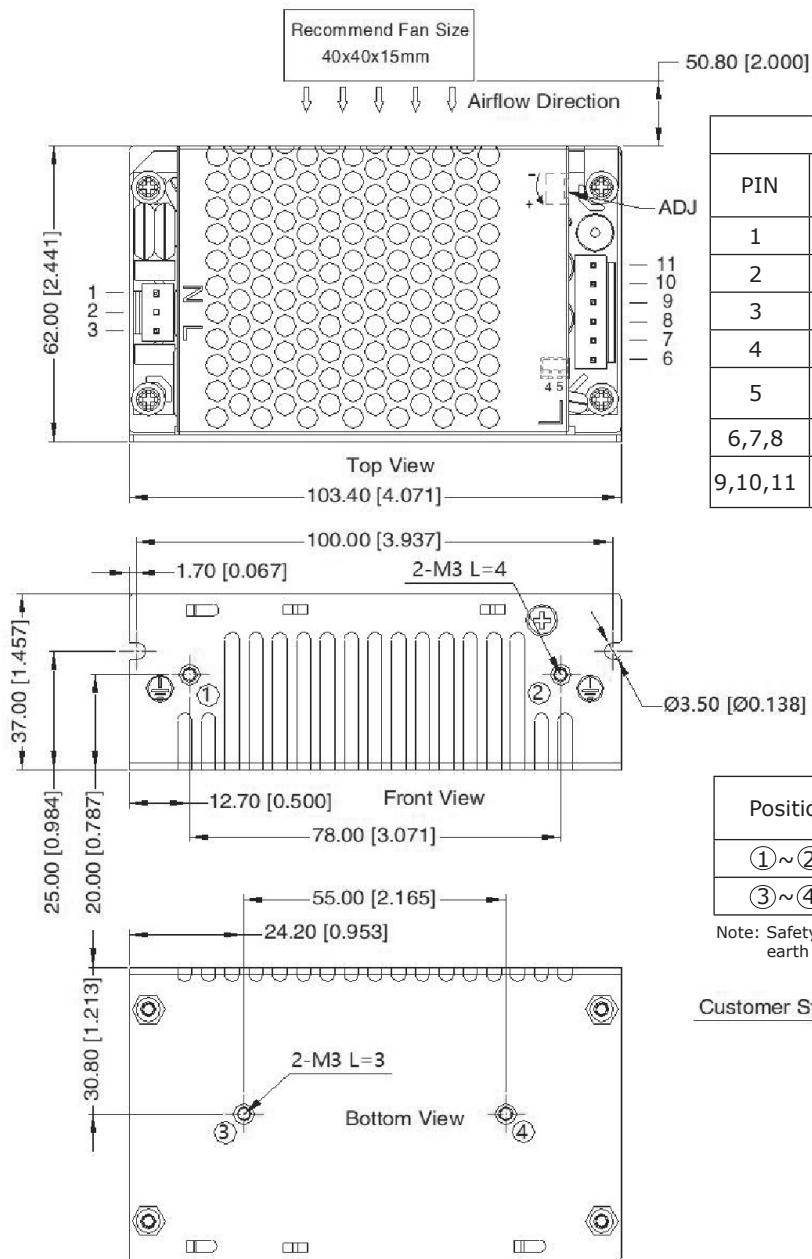

| PIN-OUT | | | |
|---------|------------|---------------------------------|--|
| PIN | Function | Product Connector | Customer Connector |
| 1 | AC (N)/DC- | JST B3P-VH or equivalent | Housing: JST VHR Contact: JST SVH-21T-P1.1 or equivalent |
| 2 | NC | | |
| 3 | AC (L)/DC+ | JST B2B-PH-K-S or equivalent | Housing: JST PHR-2 Contact: JST SPH-002T-P0.5S or equivalent |
| 4 | Fan- | | |
| 5 | Fan+ | JST B6P-VH or equivalent | Housing: JST VHR Contact: JST SVH-21T-P1.1 or equivalent |
| 6,7,8 | -Vo | | |
| 9,10,11 | +Vo | | |

| Position | Screw Spec. | L (recommended) | Torque |
|----------|-------------|--------------------|---------|
| ①~② | M3 | 4mm | 0.4 N·m |
| ③~④ | M3 | 3mm | 0.4 N·m |

Note: Safety Class I integrations require the metal case to be securely fastened to protective earth ground (⊥).

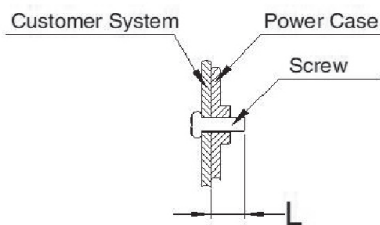

REVISION HISTORY

| rev. | description | date |
|------|-----------------|------------|
| 1.0 | initial release | 06/14/2021 |

The revision history provided is for informational purposes only and is believed to be accurate.



CUI INC
a bel group

Headquarters
20050 SW 112th Ave.
Tualatin, OR 97062
800.275.4899

Fax 503.612.2383
cui.com
techsupport@cui.com

CUI offers a two (2) year limited warranty. Complete warranty information is listed on our website.

CUI reserves the right to make changes to the product at any time without notice. Information provided by CUI is believed to be accurate and reliable. However, no responsibility is assumed by CUI for its use, nor for any infringements of patents or other rights of third parties which may result from its use.

CUI products are not authorized or warranted for use as critical components in equipment that requires an extremely high level of reliability. A critical component is any component of a life support device or system whose failure to perform can be reasonably expected to cause the failure of the life support device or system, or to affect its safety or effectiveness.