

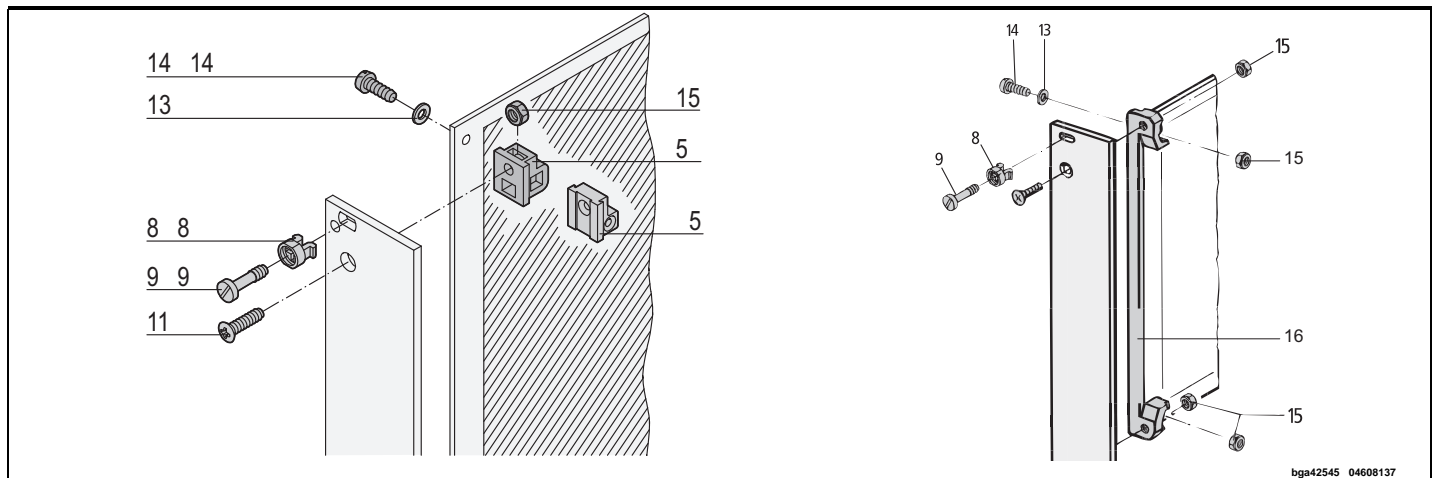











## Plug-in units – for IEC 60297, key form 2

### Individual components Fixing material for extractor handles, key form 2

#### Fixing material for extractor handles, key form 2



bga42545 04608137

Fixing material	Item	Image	Required Qty		Qty/PU	Part no.
			3 U	6 U		
Board support, die-cast zinc, with thread M2.5, for front panel and PCB fixing	5		1	2	1 piece (SPQ 10) <sup>1)</sup>	60807-181
Board support, plastic, PBT, UL 94 V-0, grey, with recess for hexagon nut M2.5, for fixing front panel	5a		1	2	1 piece (SPQ 10) <sup>1)</sup>	60807-183
Plastic sleeve, for form hole 5.9 x 3.3 PA, UL 90 V-2, grey	8		1	–	100	21100-464
Metal sleeve, for form hole 5.9 x 3.3, press-in Stainless steel	8a		1	–	100	21100-662
Pozidrive/slotted collar screw M2.5 x 11, St, nickel-plated	9		2	2	100	21100-748
Pozidrive/slotted collar screw M2.5 x 12.3, St, nickel-plated	9a		2	2	100	21101-101
Raised Pozidrive countersunk screw M2.5 x 8, St, nickel-plated	11		1	–	100	21100-429
Washer 2.7 DIN 125, St, nickel-plated, 100 pieces	13		2	2	100	21100-721
Pozidrive panhead screw M2.5 x 10, St, nickel-plated for item 5	14		2	2	100	21101-220
Panhead screw, self-tapping 2.5 x 8, St, zinc-plated for item 5b	14a		1	–	100	21100-710
Hexagon nut M2.5, nickel-plated steel for item 5b	15		3	–	100	21100-144
PCB bracket 4 clearance holes for front panel/PCB fixing, 4 recesses for hexagon nuts; PBT, UL 94 V?0, red	16		1	2	1 piece (SPQ 10)	60807-011

1) SPQ (standard pack quantity): Part number includes 1 piece, but delivery is exclusively made in standard pack quantity (SPQ); please order at least the SPQ quantity or a multiple