

MSUD VALVE PLUG FORM BI 11MM

PVC 3X0.75 YELLOW, 10m

Form BI (11 mm) industrial standard
24 V AC/DC with LED and suppression
180°, PE opposite cable outlet

Further cable lengths on request. Plastic housings with good resistance against chemicals and oils. The resistance to aggressive media should be individually tested for your application. Further details on request.

[Link to Product](#)

Illustration

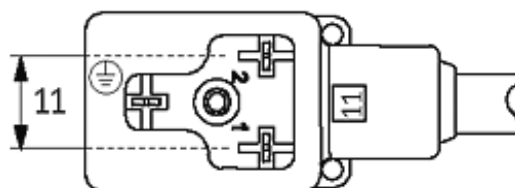
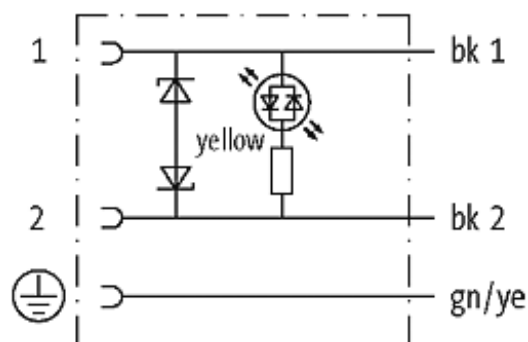

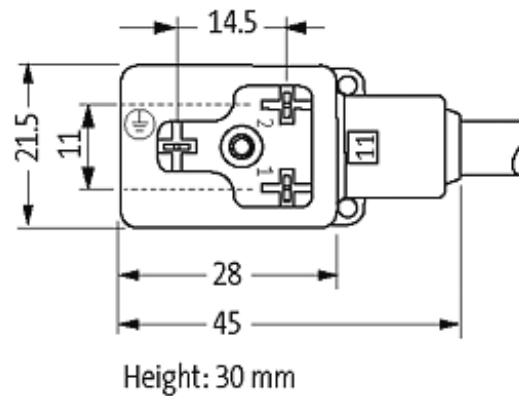

Product may differ from Image

Approvals



Form

11081

Technical Data

Operating voltage	24 V AC/DC $\pm 25\%$
Operating current per contact	max. 4 A
Switch off peak	max. 55 V
Switch off delay time	max. 20 ms
Locking of ports	M3 (recommended torque 0.4 Nm)
Protection	IP67 inserted and tightened (EN 60529)
Housing	Black plastic (gray on request)

Cables

Cable number	016
No./diameter of wires	3 \times 0.75 mm ²
Wire isolation	PVC (bk, num, gnye)
Jacket Color	yellow
Shore hardness outer jacket	80 \pm 5A
Material (jacket)	PVC
Outer diameter	approx. 5.9 mm
Bend radius (fixed)	5 \times outer \varnothing
Bend radius (moving)	10 \times outer \varnothing
Temperature range (fixed)	-30...+70 °C
Temperature range (mobile)	-5...+70 °C

General data

Temperature range	-25...+85 °C, depending on cable quality
-------------------	--

Commercial data

The information in this brochure has been compiled with the utmost care.

Liability for the correctness completeness and topicality of the information is restricted to gross negligence. Version: 05/15

Murrelektronik GmbH | Falkenstraße 3, 71570 Oppenweiler | Fon +49 (71 91) 47-0, Fax +49 (71 91) 47-491000 | shop@murrelektronik.de | shop.murrelektronik.de

country of origin	DE
customs tariff number	85444290
minimum order quantity	1