



## **SMD Varistors(CU types)**

### Standard series

<b>Series/Type:</b>	<b>SIOV-CU4032K460G2K1</b>
<b>Ordering code:</b>	<b>B72660M0461K093</b>
Date:	2020-03-09
Version:	b

## Designation system

CU	=	Chip encapsulated
4032	=	40/100" x 32/100" = 10.0 mm x 8.0 mm
K	=	Tolerance of the varistor voltage ( $\pm 10\%$ )
460	=	Max. operating voltage ( $V_{RMS,max}$ )
GX	=	Taped and reeled, with a window in carton box
K1	=	Sealed type

## Electrical data

### Maximum Ratings (85°C):

Max. operating AC voltage		$V_{RMS}$	=	460 V
Max. operating DC voltage		$V_{DC}$	=	615 V
Surge current (8/20 $\mu$ s)	1 time	$I_{max}$	=	1000 A
Energy absorption (2 ms)	1 time	$W_{max}$	=	36.0 J
Average power dissipation		$P_{max}$	=	0.25 W

### Characteristics (25°C):

Varistor voltage at 1mA		$V_V$	=	750V $\pm$ 10%
Clamping voltage at 10 A (8/20 $\mu$ s)		$V_{C,max}$	=	1240 V
Typ. capacitance at 1 kHz		C	=	55 Pf
Operating temperature				-40 ... +85 °C
Storage temperature (mounted parts)				-40 ... +125 °C

### V/I characteristic

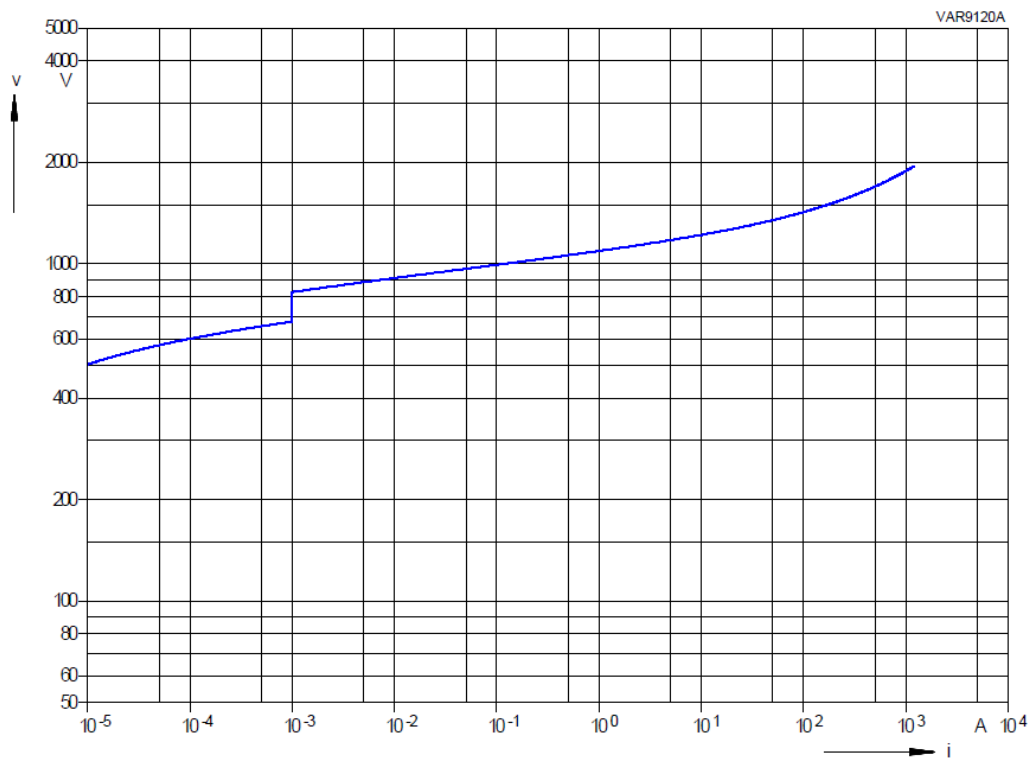

### Derating curves

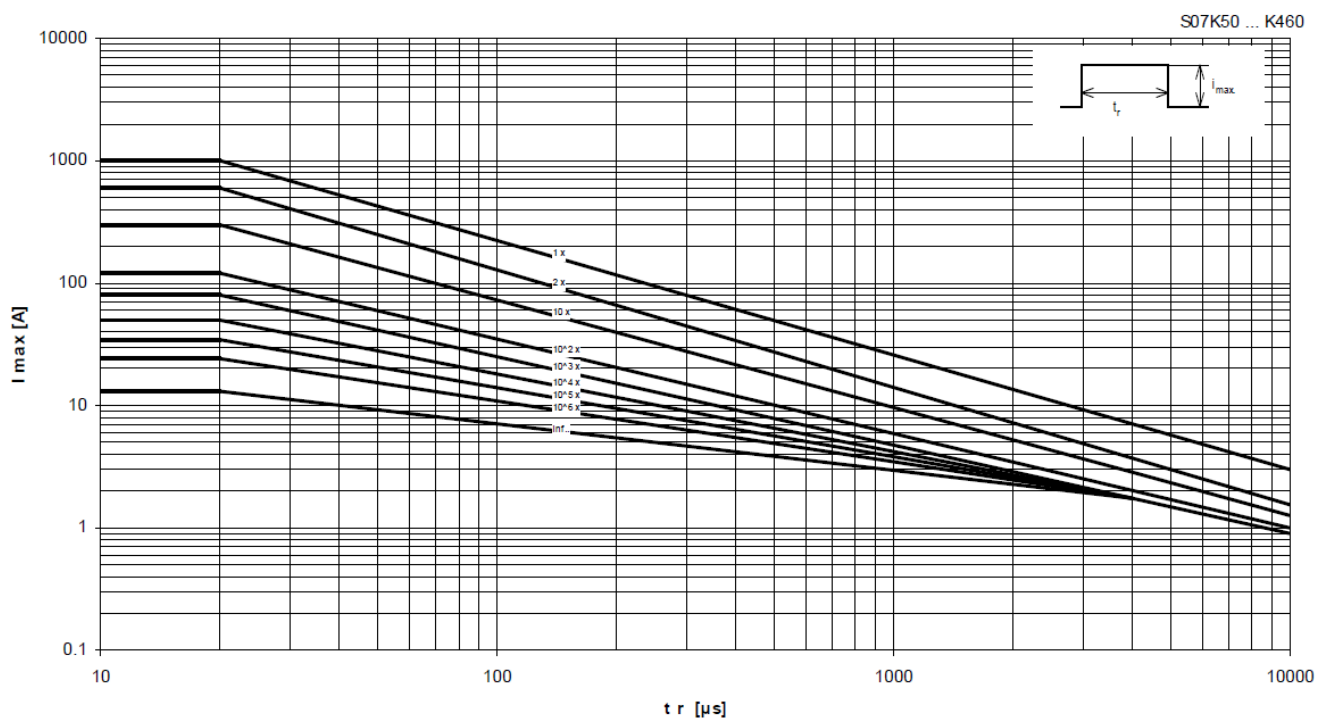

### Temperature derating

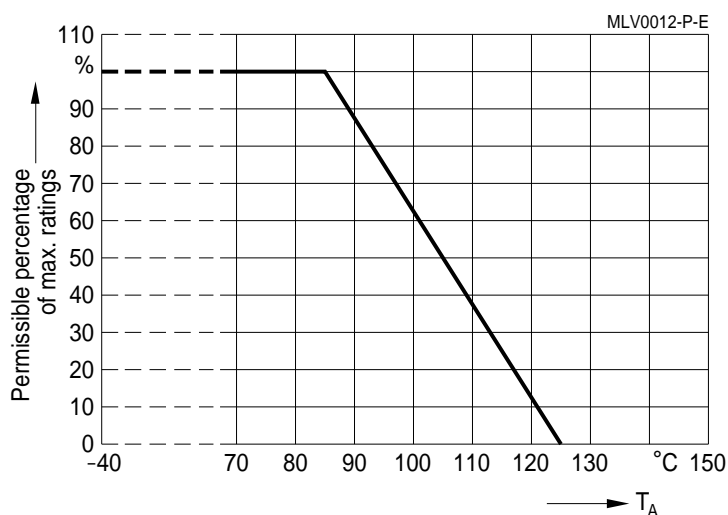

### Dimensional drawing in mm

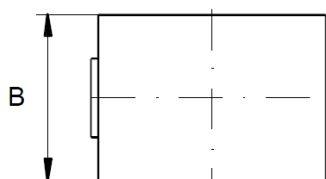
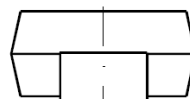
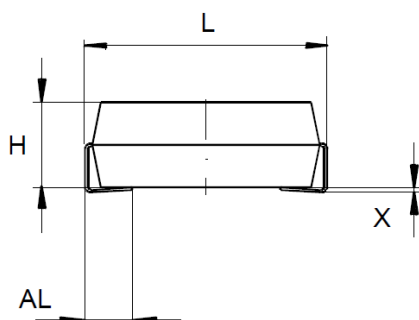

- L = 10,2 +/- 0,3 mm
- B = 8,0 +/- 0,3 mm
- H = 4,5 +/- 0,3 mm
- AL = 1,5 +/- 0,3 mm
- Xmax = 0,3 mm

### Recommended solder pad layout

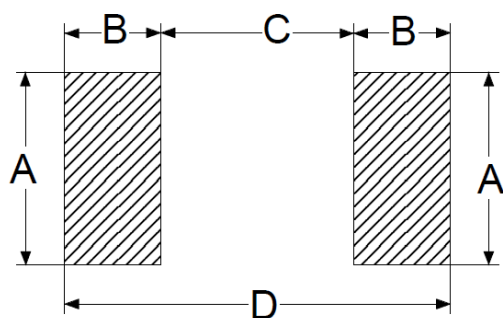

- A = 3.5 mm
- B = 2.8 mm
- C = 6.5 mm
- D = 12.1 mm

## Recommended temperature profile in wave soldering

### Reflow soldering temperature profile

#### Recommended temperature characteristic for reflow soldering following JEDEC J-STD-020D

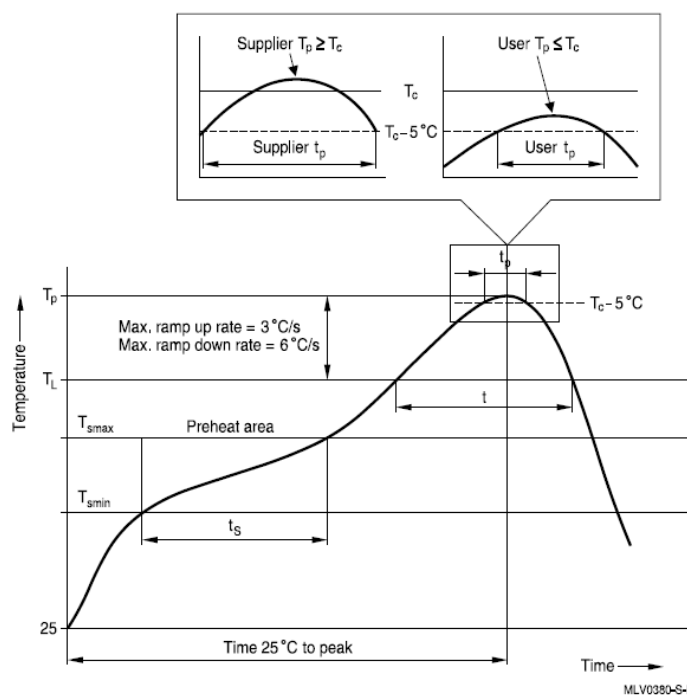

Profile feature		Sn-Pb eutectic assembly	Pb-free assembly
Preheat and soak			
- Temperature min	$T_{smin}$	100 °C	150 °C
- Temperature max	$T_{smax}$	150 °C	200 °C
- Time	$t_{smin}$ to $t_{smax}$	60 ... 120 s	60 ... 180 s
Average ramp-up rate	$T_{smax}$ to $T_p$	3 °C/ s max.	3 °C/ s max.
Liquidous temperature	$T_L$	183 °C	217 °C
Time at liquidous	$t_L$	60 ... 150 s	60 ... 150 s
Peak package body temperature	$T_p$ <sup>1)</sup>	220 °C ... 235 °C <sup>2)</sup>	245 °C ... 260 °C <sup>2)</sup>
Time ( $t_p$ ) <sup>3)</sup> within 5 °C of specified classification temperature ( $T_c$ )		20 s <sup>3)</sup>	30 s <sup>3)</sup>
Average ramp-down rate	$T_p$ to $T_{smax}$	6 °C/ s max.	6 °C/ s max.
Time 25 °C to peak temperature		maximum 6 min	maximum 8 min

1) Tolerance for peak profile temperature ( $T_p$ ) is defined as a supplier minimum and a user maximum.

2) Depending on package thickness. For details please refer to JEDEC J-STD-020D.

3) Tolerance for time at peak profile temperature ( $t_p$ ) is defined as a supplier minimum and a user maximum.

**Note:** All temperatures refer to topside of the package, measured on the package body surface.

Number of reflow cycles: 3

### Wave soldering temperature profile

Temperature characteristic at component terminal with dual-wave soldering

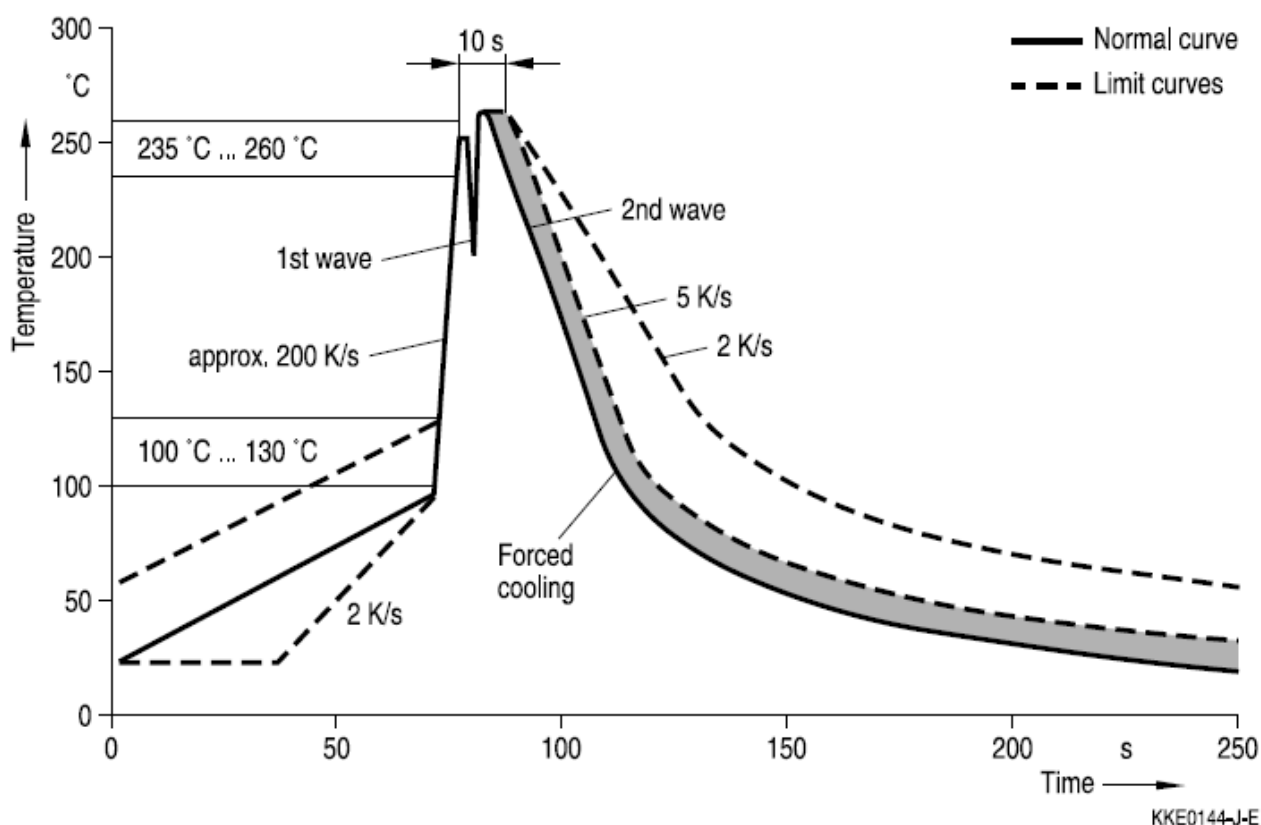

### Soldering guidelines

The usage of mild, non-activated fluxes for soldering is recommended, as well as proper cleaning of the PCB.

### Storage condition

- As far as possible, the components should be employed within 24 months after delivery from TDK Electronics.
- They should be left in their original packings to avoid soldering problems due to oxidized contacts.
- Storage temperature: - 25 up to + 45°C.
- Relative humidity: < 75 % annual average, < 95 % on max. 30 days in a year.

## Taping and packaging

Tape and reel packing according to IEC 60286-3

Tape material: Blister

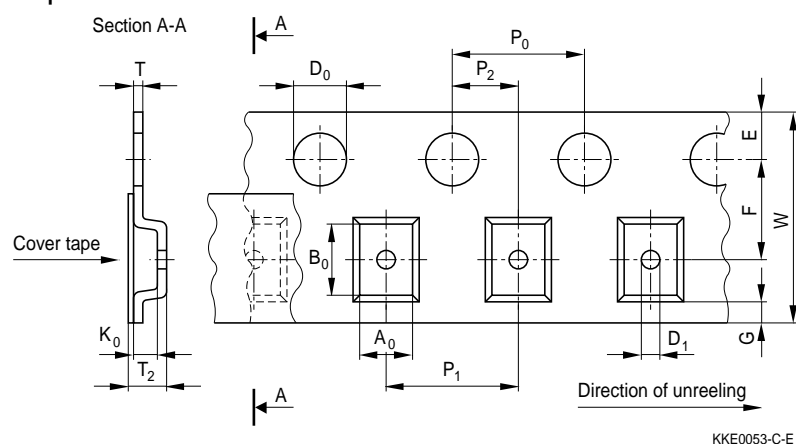

### Dimensions and tolerances

Definition	Symbol	Dimension [mm]	Tolerance [mm]
Compartment width	A <sub>0</sub>	8.60	+/- 0.20
Compartment length	B <sub>0</sub>	10.20	+/-0.20
Compartment height	K <sub>0</sub>	4.50	+/-0.20
Sprocket hole diameter	D <sub>0</sub>	1.50	+ 0.10 / -0.0
Compartment hole diameter	D <sub>1</sub>	1.50	min
Sprocket hole pitch	P <sub>0</sub>	4.0	+/- 0.10
Distance center hole to center compartment	P <sub>2</sub>	2.0	+/- 0.10
Pitch of the component compartments	P <sub>1</sub>	12.0	+/- 0.10
Tape width	W	16.0	+/- 0.30
Distance edge to center of hole	E	1.75	+/- 0.10
Distance center hole to center compartment	F	7.50	+/- 0.10
Distance compartment to edge	G	0.75	min
Overall thickness	T <sub>2</sub>	5.5	max
Thickness tape	T	0.3	max

<sup>1)</sup> ≤±0.2 mm over any 10 pitches

Package: 16-mm tape

### Packing

Packing material: Plastic

### Reel dimensions

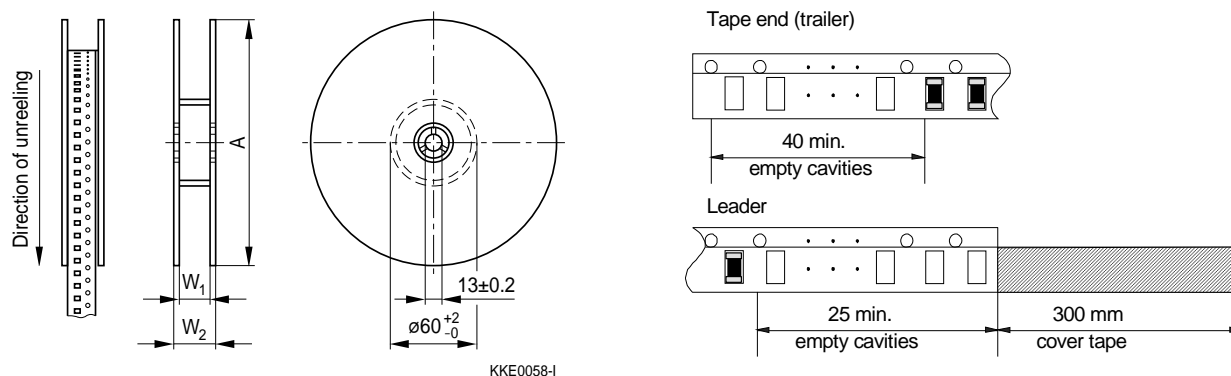

Dinition	Symbol	Dimension [mm]	Tolerance [mm]
Reel diameter	A	330	+0 /-2
Reel width (inside)	W <sub>1</sub>	16.4	+1.5 /-0
Reel width (outside)	W <sub>2</sub>	22.4	max.

Packing unit: 1000 pcs. / reel



## Cautions and warnings

### General

1. TDK Electronics metal oxide varistors (SIOVs) are designed for specific applications and should not be used for purposes not identified in our specifications, application notes and data books unless otherwise agreed with TDK Electronics during the design-in-phase.
2. Ensure suitability of SIOVs through reliability testing during the design-in phase. The SIOVs should be evaluated taking into consideration worst-case conditions.
3. For applications of SIOVs in line-to ground circuits based on various international and local standards there are restrictions existing or additional safety measures required.

### Storage

1. Store SIOVs only in original packaging. Do not open the package before storage.
2. Storage conditions in original packaging:  

Storage temperature:	-25 °C ... +45 °C
Relative humidity:	<75% annual average, <95% on maximum 30 days a year.
Dew precipitation:	Is to be avoided.
3. Avoid contamination of SIOVs surface during storage, handling and processing.
4. Avoid storage of SIOVs in harmful environments which can affect the function during long-term operation (examples given under operation precautions).
5. The SIOV type series should be soldered after shipment from TDK Electronics within the time specified.  

SIOV-S, -Q, -SNF, -LS	24 months.
ETFV and SFS types	12 months.

### Handling

1. SIOVs must not be dropped.
2. Components must not be touched with bare hands. Gloves are recommended.
3. Avoid contamination of the surface of SIOV electrodes during handling, be careful of the sharp edge of SIOV electrodes.

### Soldering (where applicable)

1. Use rosin-type flux or non-activated flux.
2. Insufficient preheating may cause ceramic cracks.
3. Rapid cooling by dipping in solvent is not recommended.
4. Complete removal of flux is recommended.

### Mounting

1. Potting, sealing or adhesive compounds can produce chemical reactions in the SIOV ceramic that will degrade the component's electrical characteristics.
2. Overloading SIOVs may result in ruptured packages and expulsion of hot materials. For this reason the SIOVs should be physically shielded from adjacent components.

### Operation

1. Use SIOVs only within the specified temperature operating range
2. Use SIOVs only within the specified voltage and current ranges.
3. Environmental conditions must not harm the SIOVs. Use SIOVs only in normal atmospheric conditions. Avoid use in the presence of deoxidizing gases (chlorine gas, hydrogen sulfide gas, ammonia gas, sulfuric acid gas, etc), corrosive agents, humid or salty conditions, Avoid contact with any liquids and solvents.

### Display of ordering codes for TDK Electronics products

The ordering code for one and the same product can be represented differently in data sheets, data books, other publications, on the company website, or in order-related documents such as shipping notes, order confirmations and product labels. **The varying representations of the ordering codes are due to different processes employed and do not affect the specifications of the respective products.** Detailed information can be found on the Internet under [www.tdk-electronics.tdk.com/orderingcodes](http://www.tdk-electronics.tdk.com/orderingcodes).

## Important notes

The following applies to all products named in this publication:

1. Some parts of this publication contain **statements about the suitability of our products for certain areas of application**. These statements are based on our knowledge of typical requirements that are often placed on our products in the areas of application concerned. We nevertheless expressly point out **that such statements cannot be regarded as binding statements about the suitability of our products for a particular customer application**. As a rule we are either unfamiliar with individual customer applications or less familiar with them than the customers themselves. For these reasons, it is always ultimately incumbent on the customer to check and decide whether a product with the properties described in the product specification is suitable for use in a particular customer application.
2. We also point out that **in individual cases, a malfunction of electronic components or failure before the end of their usual service life cannot be completely ruled out in the current state of the art, even if they are operated as specified**. In customer applications requiring a very high level of operational safety and especially in customer applications in which the malfunction or failure of an electronic component could endanger human life or health (e.g. in accident prevention or life-saving systems), it must therefore be ensured by means of suitable design of the customer application or other action taken by the customer (e.g. installation of protective circuitry or redundancy) that no injury or damage is sustained by third parties in the event of malfunction or failure of an electronic component.
3. **The warnings, cautions and product-specific notes must be observed.**
4. In order to satisfy certain technical requirements, **some of the products described in this publication may contain substances subject to restrictions in certain jurisdictions (e.g. because they are classed as hazardous)**. Useful information on this will be found in our Material Data Sheets on the Internet ([www.tdk-electronics.tdk.com/material](http://www.tdk-electronics.tdk.com/material)). Should you have any more detailed questions, please contact our sales offices.
5. We constantly strive to improve our products. Consequently, **the products described in this publication may change from time to time**. The same is true of the corresponding product specifications. Please check therefore to what extent product descriptions and specifications contained in this publication are still applicable before or when you place an order.

We also **reserve the right to discontinue production and delivery of products**. Consequently, we cannot guarantee that all products named in this publication will always be available. The aforementioned does not apply in the case of individual agreements deviating from the foregoing for customer-specific products.

6. Unless otherwise agreed in individual contracts, **all orders are subject to our General Terms and Conditions of Supply**.
7. **Our manufacturing sites serving the automotive business apply the IATF 16949 standard**. The IATF certifications confirm our compliance with requirements regarding the quality management system in the automotive industry. Referring to customer requirements and customer specific requirements ("CSR") TDK always has and will continue to have the policy of respecting individual agreements. Even if IATF 16949 may appear to support the acceptance of unilateral requirements, we hereby like to emphasize that **only requirements mutually agreed upon can and will be implemented in our Quality Management System**. For clarification purposes we like to point out that obligations from IATF 16949 shall only become legally binding if individually agreed upon.

## Important notes

8. The trade names EPCOS, CeraCharge, CeraDiode, CeraLink, CeraPad, CeraPlas, CSMP, CTVS, DeltaCap, DigiSiMic, ExoCore, FilterCap, FormFit, LeaXield, MiniBlue, MiniCell, MKD, MKK, MotorCap, PCC, PhaseCap, PhaseCube, PhaseMod, PhiCap, PowerHap, PQSine, PQvar, SIFERRIT, SIFI, SIKOREL, SilverCap, SIMDAD, SiMic, SIMID, SineFormer, SIOV, ThermoFuse, WindCap are **trademarks registered or pending** in Europe and in other countries. Further information will be found on the Internet at [www.tdk-electronics.tdk.com/trademarks](http://www.tdk-electronics.tdk.com/trademarks).

Release 2018-10