

## SPECIFICATION

- Part No. : **MA310.A.LB.003**
- Product Name : Magnet Mount GPS/GLONASS-SMA(M) 4G  
LTE/Cellular-SMA(M) 3M CFD-200
- Features : 1\*LTE Antenna  
1\*Active GNSS Antenna - GPS L1 and GLONASS L1  
Permanent (Screw) Mounting  
IP67 Rated Enclosure  
LTE: 3M TGC-200 Cable and SMA(M)ST Connector  
GNSS: 3M RG-174 Cable and SMA(M)ST Connector  
Dims: mm  
**RoHS Compliant**



## 1. Introduction

The MA310 antenna is a combination small form factor high performance GPS/GLONASS and Penta-band Cellular (GSM/GPRS/CDMA/ PCS/DCS/ WCDMA/UMTS) antenna to simplify AVL or Fleet management antenna systems worldwide.

It comes with magnetic mount as standard. An internal O-ring meets stringent IP-67 waterproof standards. With the strongest GPS/GLONASS and Cellular antenna design team in the industry and rigorous testing Taoglas offers guaranteed performance with your system and your environment.

The standard version comes with 3 metres RG174 cable and SMA(M) connectors for both GPS/GLONASS and TGC-200 for Cellular feeds. Cables and connectors are customizable upon requests.

### Features

#### GPS/GLONASS

- High LNA Gain up to 31 dB
- Antenna Gain  $28 \pm 2$  dB
- Miniaturized to 56.2 x 16.8 mm
- Low Noise Figure 2.8 dB typ. for GPS
- 3.2 dB typ. for GLONASS
- Ultra-Low Power Consumption 7~10mA typ. ( at 3.3V DC)

#### Cellular

- Advanced penta-band cellular antenna (GSM/GPRS/CDMA/PCS/DCS/WCDMA/UMTS/HSPA)
- GSM850: 824~896MHz, GSM900: 880~960MHz,
- DCS: 1710~1880MHz, DCS: 1850~1990MHz
- UMTS/WCDMA/HSPA: 1920~2170MHz

#### Other

- IP67 Water Resistant due to Internal O-Ring Structure
- Quality textured covert design. Low profile.
- ABS housing
- Optional cables and connectors

- ROHS Compliant

## 2. Specification

LTE Antenna								
Frequency (MHz)		LTE700	GSM850	GSM900	DCS	PCS	UMTS1	LTE2600
		698~824	824~894	880~960	1710~1880	1850~1990	1920~2170	2490~2690
Efficiency (%)								
Free Space	0.3M	24.98	63.74	66.67	50.46	60.06	58.44	40.03
	1M	23.74	60.87	63.66	46.01	54.76	53.84	36.51
	2M	22.15	55.72	58.06	41.00	48.41	47.18	31.73
	3M	20.44	51.81	54.05	36.44	42.61	41.71	27.66
On 30x30cm Ground Plane	0.3M	36.38	53.95	41.12	61.58	58.88	53.86	47.87
	1M	34.52	51.52	39.26	56.16	53.70	49.62	43.66
	2M	32.22	47.22	35.81	50.05	47.49	43.48	37.74
	3M	29.79	43.85	33.35	44.50	41.79	38.45	32.64
Average Gain (dB)								
Free Space	0.3M	-6.02	-1.96	-1.76	-2.97	-2.21	-2.33	-3.98
	1M	-6.25	-2.16	-1.96	-3.37	-2.62	-2.69	-4.38
	2M	-6.55	-2.54	-2.36	-3.87	-3.15	-3.26	-4.99
	3M	-6.89	-2.86	-2.67	-4.38	-3.71	-3.80	-5.58
On 30x30cm Ground Plane	0.3M	-4.39	-2.68	-3.86	-2.11	-2.30	-2.69	-3.20
	1M	-4.62	-2.88	-4.06	-2.51	-2.70	-3.04	-3.60
	2M	-4.92	-3.26	-4.46	-3.01	-3.23	-3.62	-4.23
	3M	-5.26	-3.58	-4.77	-3.52	-3.79	-4.15	-4.86
Peak Gain (dBi)								
Free Space	0.3M	-4.01	-1.14	-1.31	-2.33	-1.71	-1.71	-2.69
	1M	-4.21	-1.34	-1.51	-2.73	-2.11	-2.11	-3.09
	2M	-4.51	-1.74	-1.91	-3.23	-2.71	-2.71	-3.69
	3M	-4.91	-2.04	-2.21	-3.83	-3.21	-3.21	-4.19
On 30x30cm Ground Plane	0.3M	-3.13	-2.43	-2.81	-1.62	-2.10	-2.10	-2.76
	1M	-3.33	-2.63	-3.01	-2.02	-2.50	-2.50	-3.16
	2M	-3.63	-3.03	-3.41	-2.52	-3.10	-3.10	-3.86
	3M	-4.03	-3.33	-3.71	-3.02	-3.60	-3.60	-4.46
Impedance	50 $\Omega$							
Return loss	< -3 dB							
Polarization	Vertical							

GNSS ELECTRICAL			
Frequency	GPS L1: 1575.42 MHz ± 1.023 MHz GLONASS L1: 1602 MHz ± 1.023 MHz		
Bandwidth - Return Loss <-10 dB	6 MHz min		
Return loss (GPS L1 GLONASS L1)	< -10 dB		
Passive Gain at Zenith (GPS L1 and GLONASS L1)	+1.0 dBic typ.		
Polarization	RHCP		
Impedance	50 Ω		
LNA Out-band Attenuation	fo = 1575.42MHz fo ± 30 MHz 5dB Min. fo ± 50 MHz 20dB Min. fo ± 100 MHz 25dB Min.		
Input Voltage	Min:1.8V	Typ. 3.0V	Max: 5.5V
Total Gain @ Zenith	25dBic	27dBic	29dBic
Current Consumption	6mA	12mA	30mA
Noise Figure	3.5dB	3.5dB	3.7dB

<b>MECHANICAL</b>	
Dimensions	Φ 77*21mm
Cable	LTE: 3000mm TGC-200 GNSS: 3000mm RG-174
Connector	LTE: SMA(M) GNSS: SMA(M)
Casing	PC+ABS
Adhesive	3M 9448HK + CR4305
Sealant	Rubber Stopper
Weight	g
<b>ENVIRONMENTAL</b>	
Protection	IP67
Corrosion	5% NaCl for 96hrs - Nickel plated steel base and thread
Temperature Range	-40°C to +85°C
Thermal Shock	100 cycles -40°C to +85°C
Humidity	Non-condensing 65°C 95% RH
Shock (Drop Test)	1m drop on concrete 6 axes
Cable Pull	8 Kgf
Recommended Mounting Torque	N·m
Maximum Mounting Torque	N·m

### 3. Antenna Characteristics

#### 3.1. LTE Antennas

##### 3.1.1. Return Loss – LTE

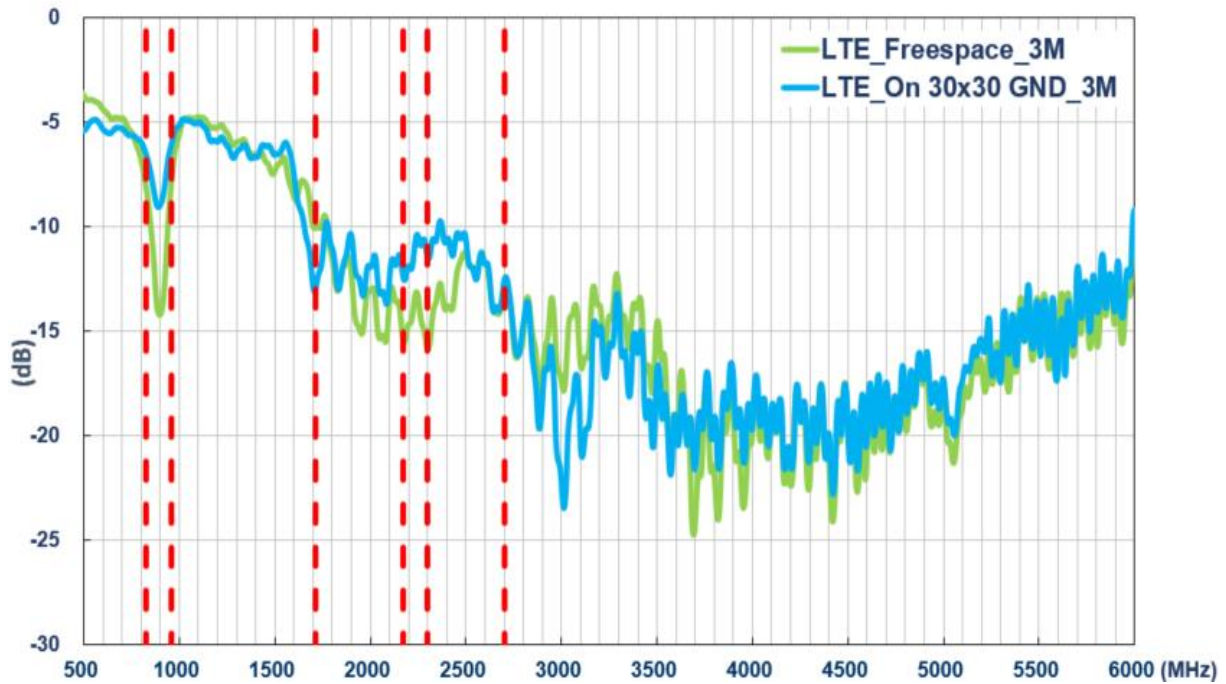

##### 3.1.2. Efficiency – LTE

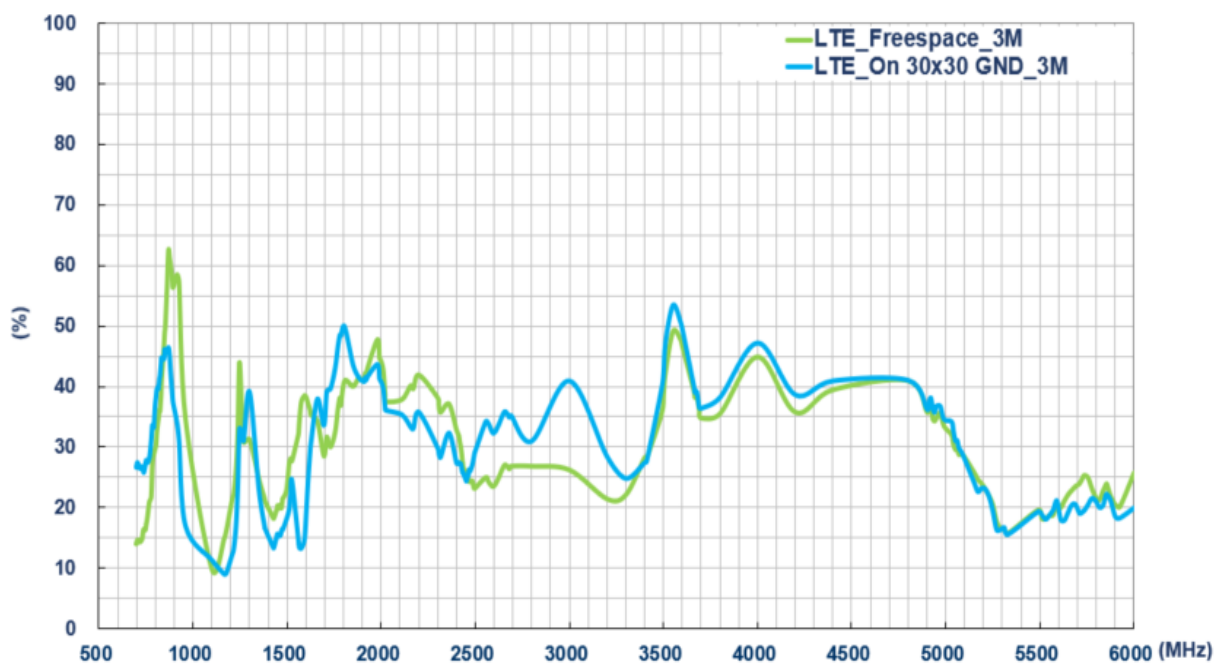

### 3.1.3. Average Gain – LTE

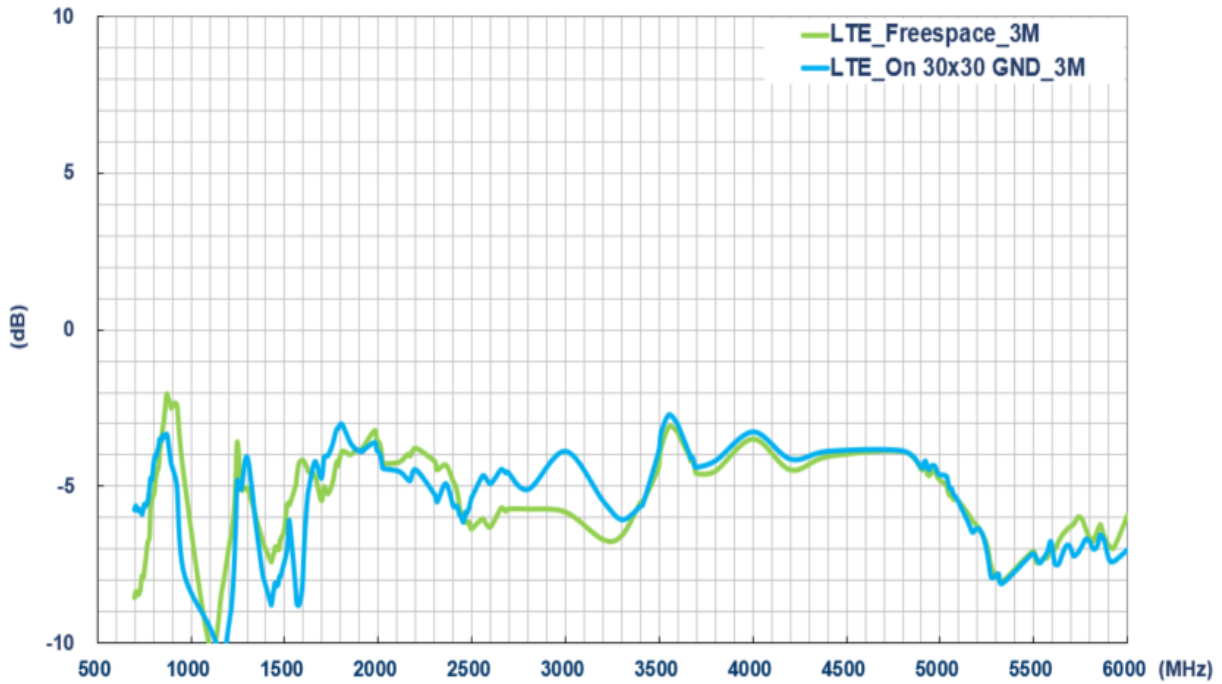

### 3.1.4. Peak Gain – LTE

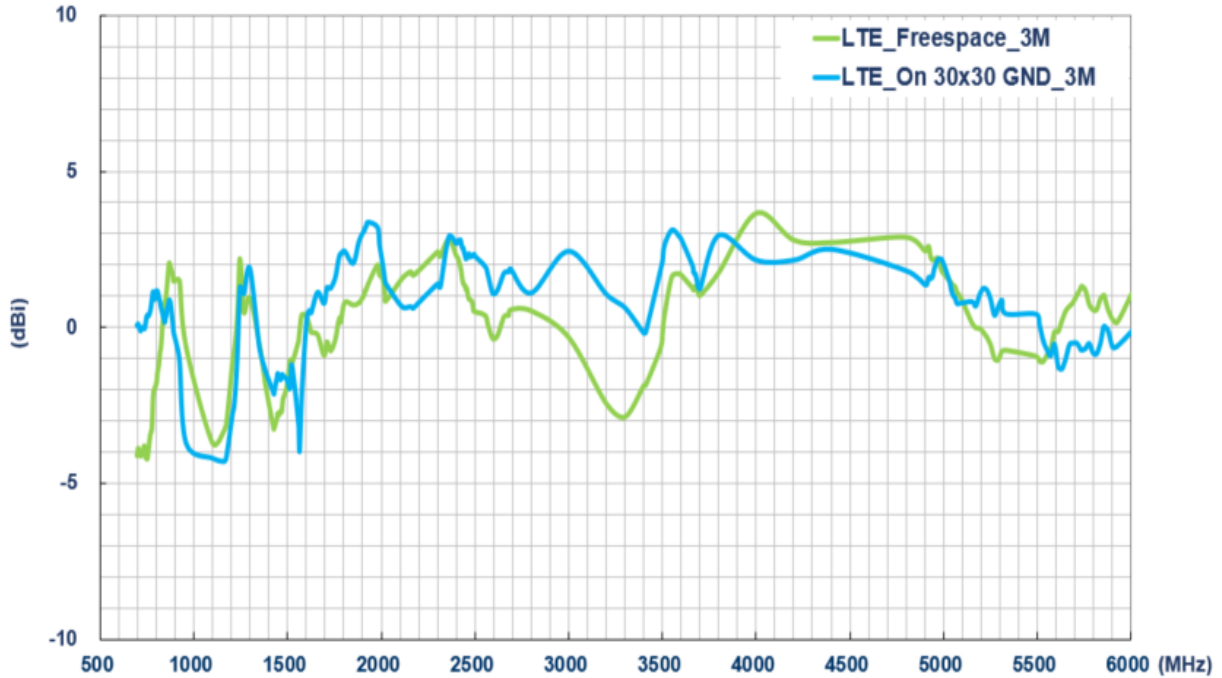

### 3.2. GNSS Antenna

#### 3.2.1. Block Diagram (Active antenna)

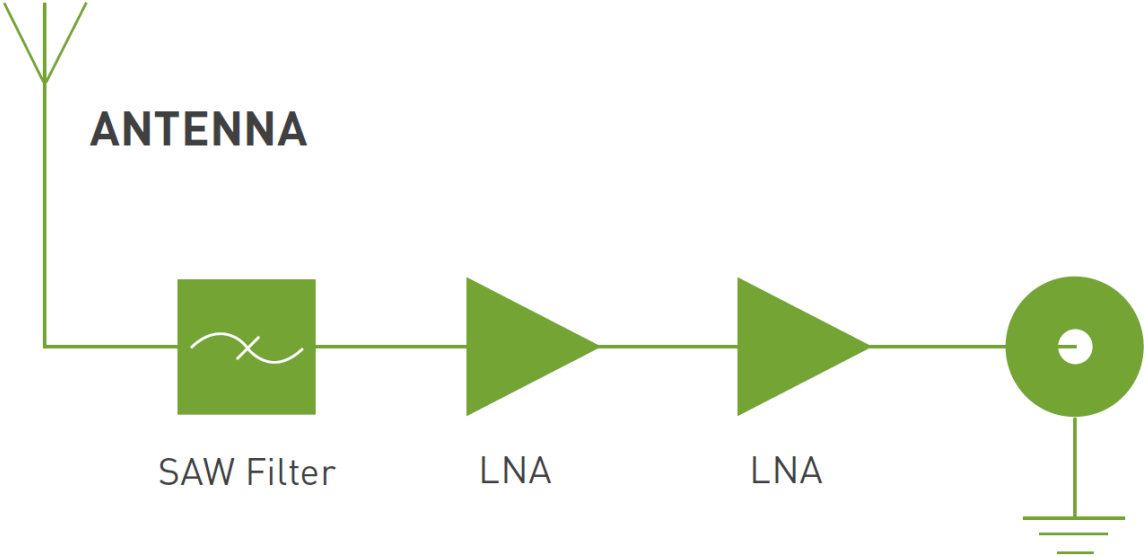

#### 3.2.2. Return Loss – GNSS Antenna

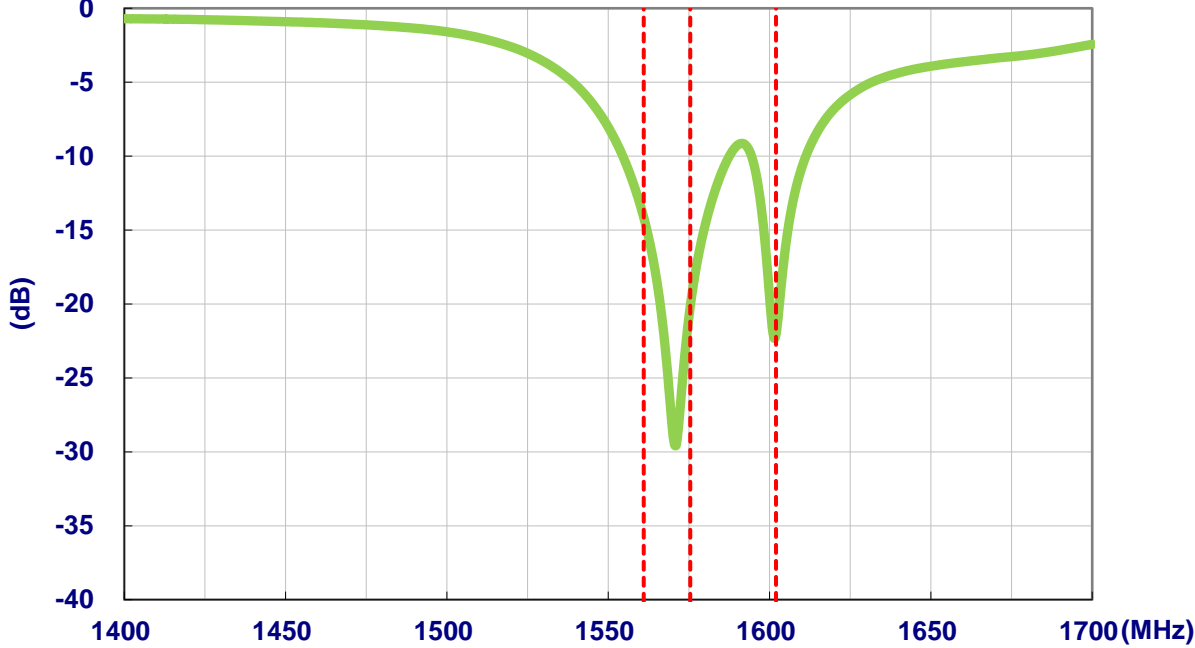



### 3.2.3. Impedance – GNSS Antenna

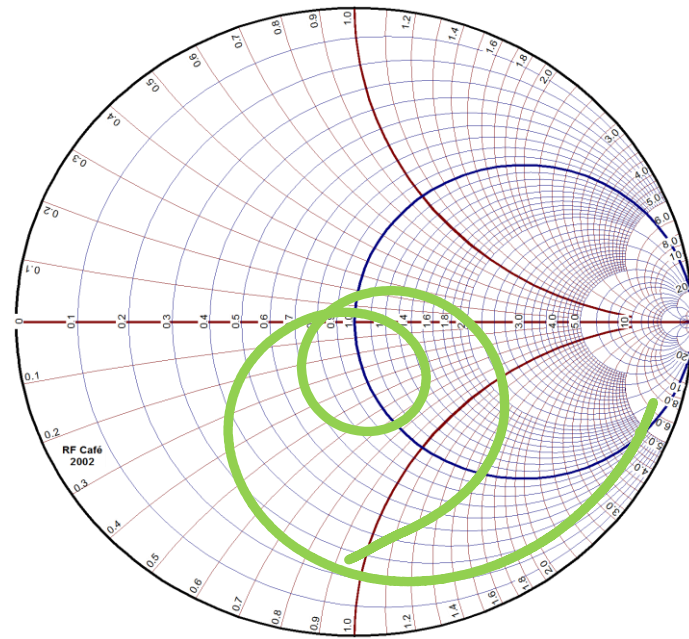

### 3.2.4. Efficiency – GNSS Antenna (passive measurement)

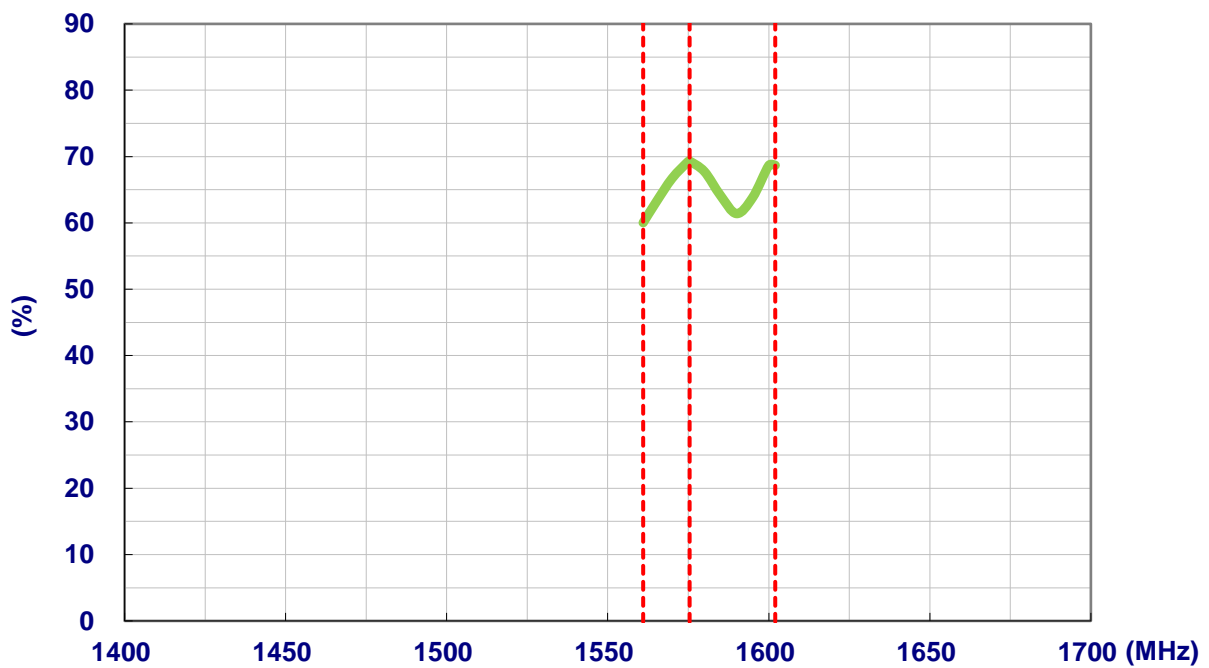

### 3.2.5. Average Gain – GNSS Antenna (passive measurement)

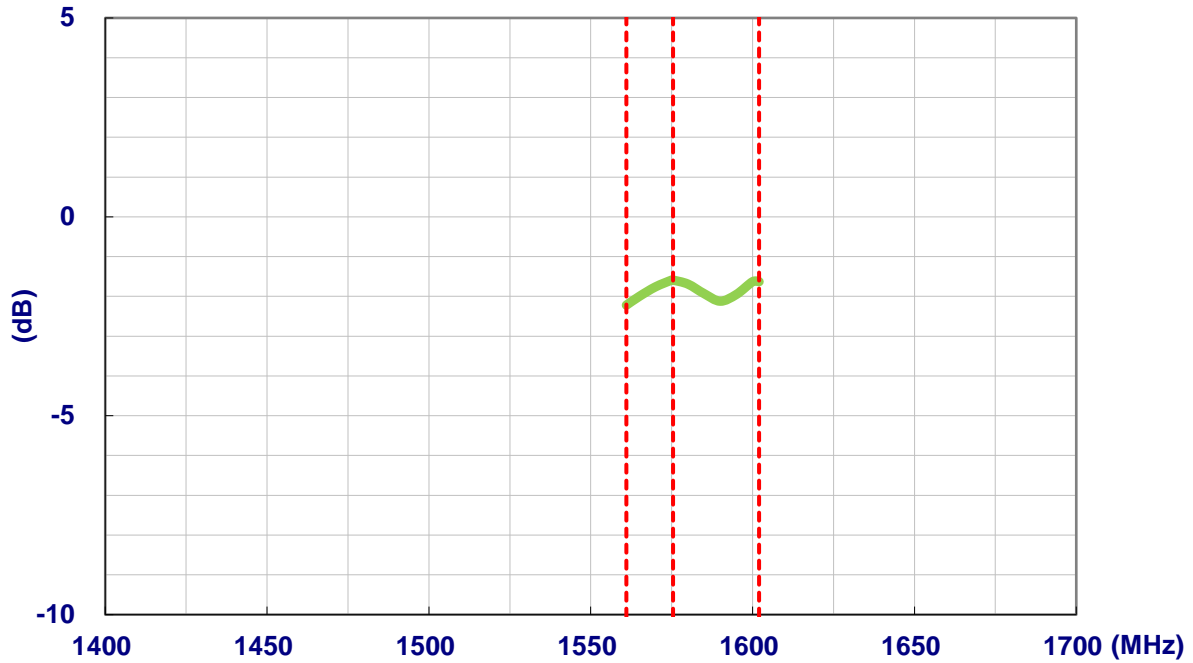

### 3.2.6. Peak Gain – GNSS Antenna (passive measurement)

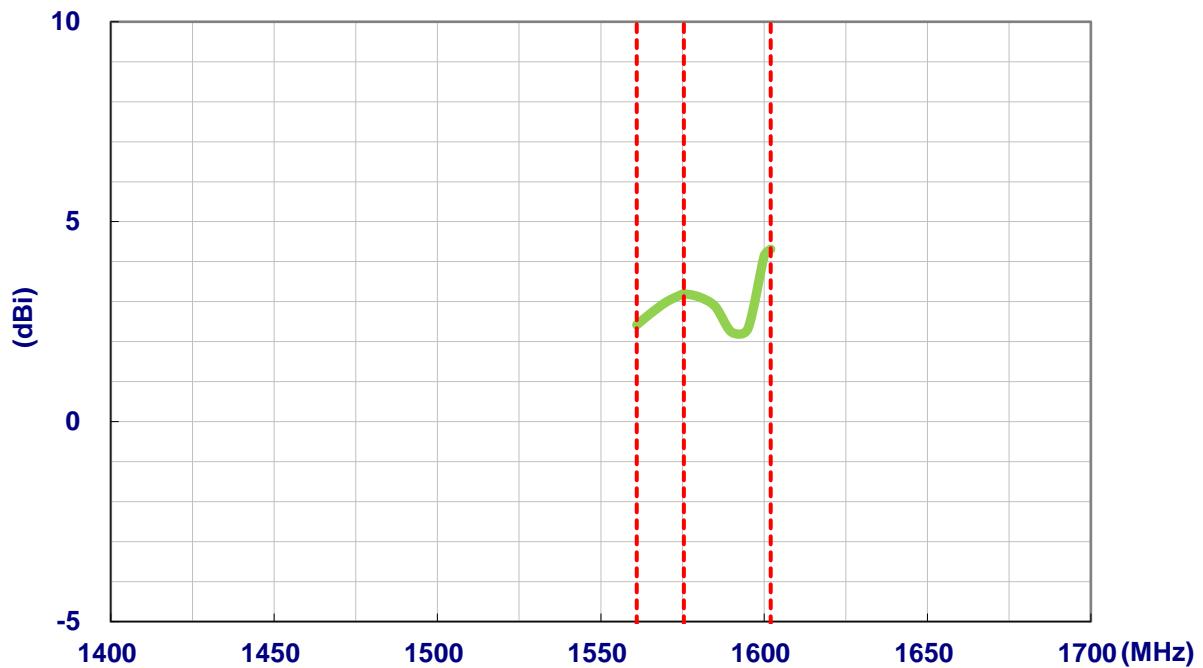

### 3.2.7. Axial Ratio – GNSS Antenna (Zenith is at 0°)

**Axial Ratio at GPS L1 (1575.42 MHz)**

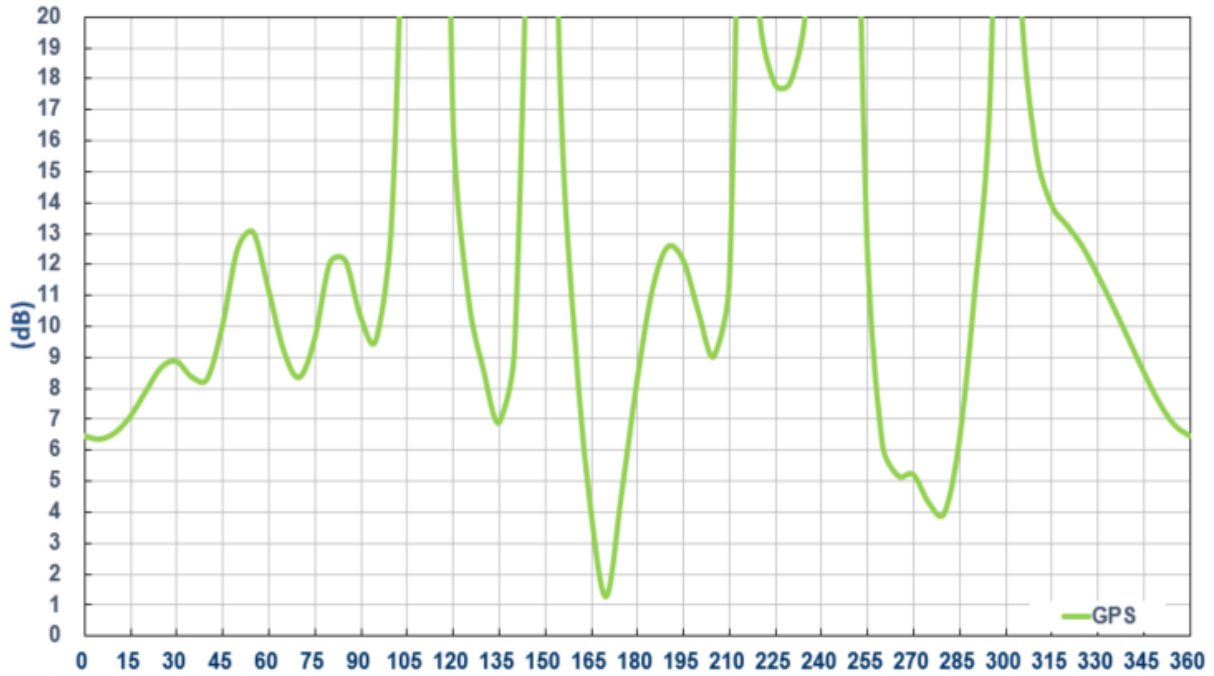

**Axial Ratio at GLONASS L1 (1602 MHz)**

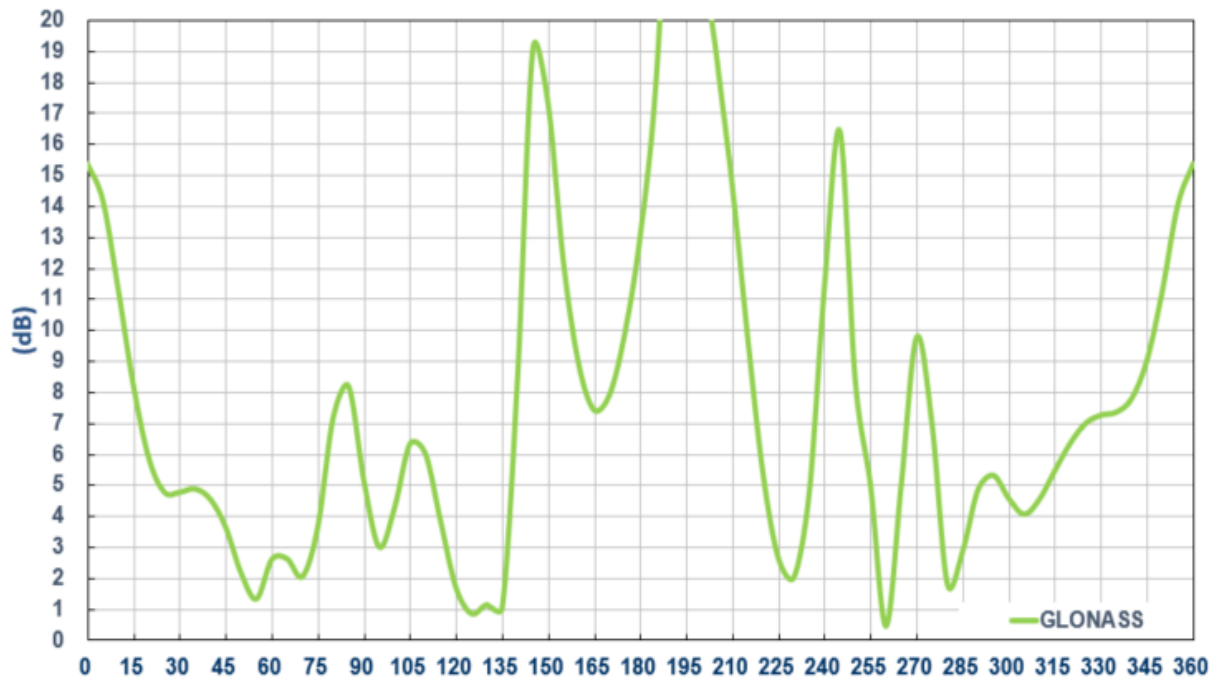

### 3.2.8. GNSS Antenna Active Measurements

#### LNA Gain @ 3.0V

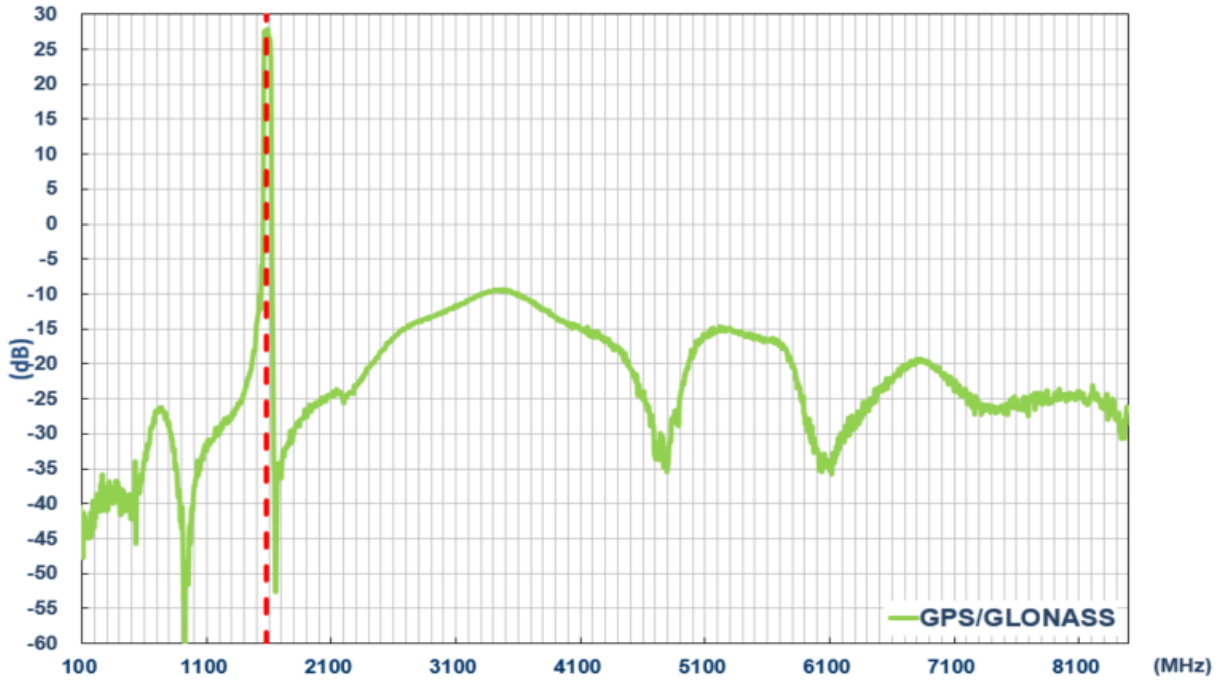

#### LNA Gain and Noise Figure @ 3.0V

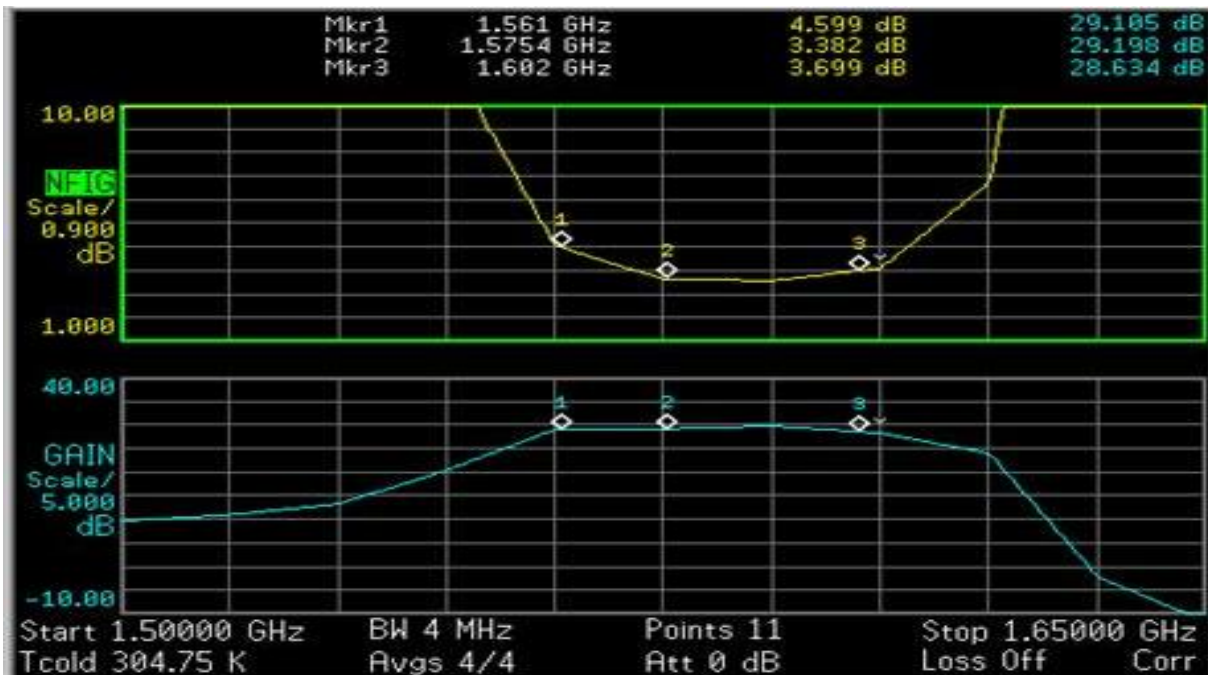

## 4. Antenna Radiation Patterns

### 4.1 Antenna Setup

#### Free Space

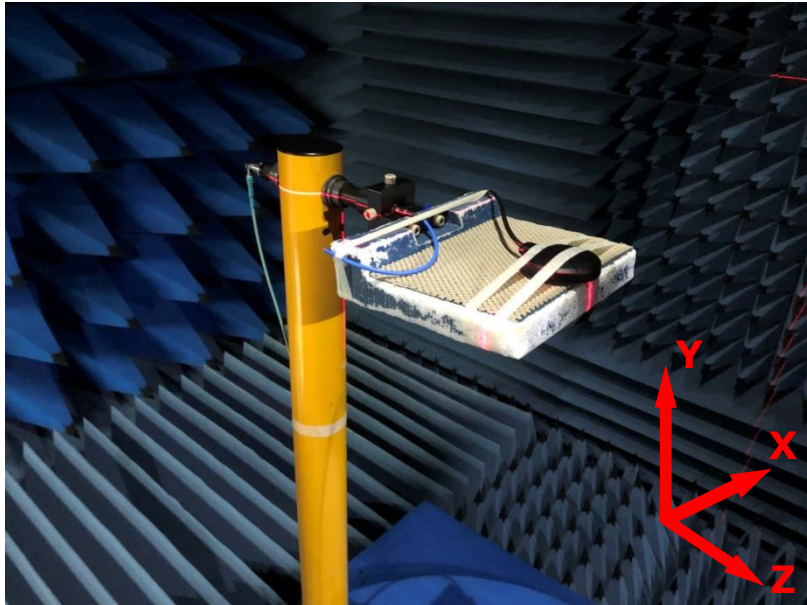

#### On 30\*30cm GND

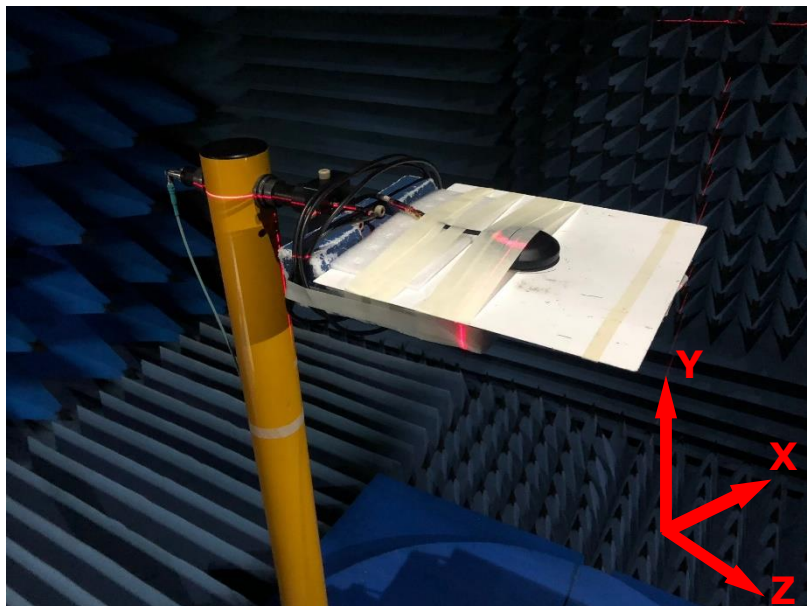

## 4.2 2D Radiation Patterns

### 4.2.1 LTE\_Free Space

#### XY Plane

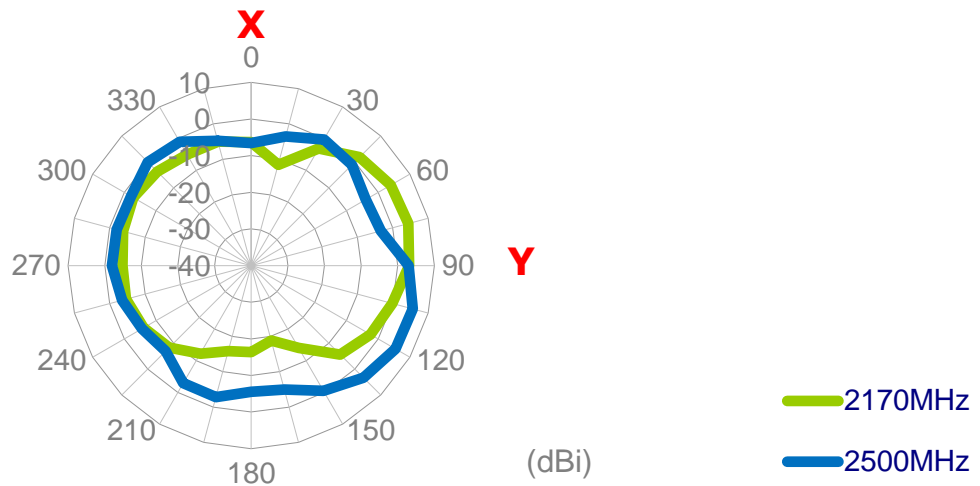
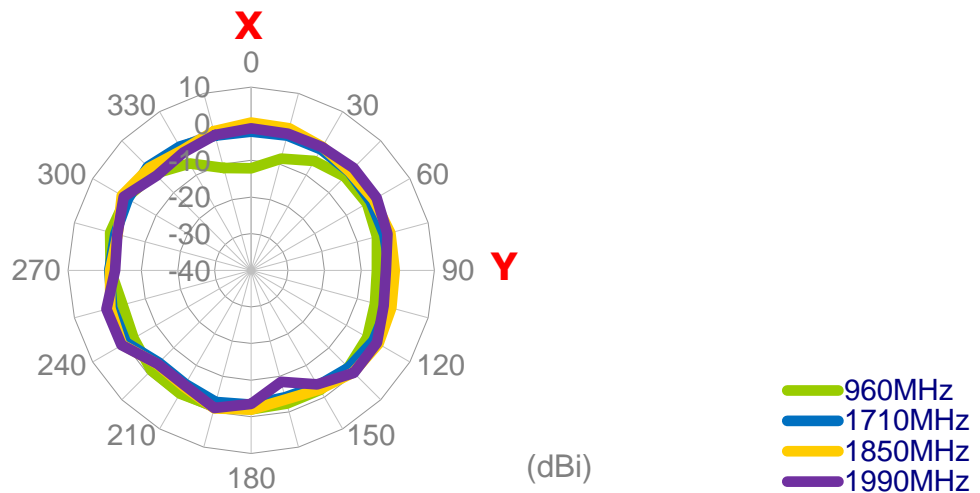
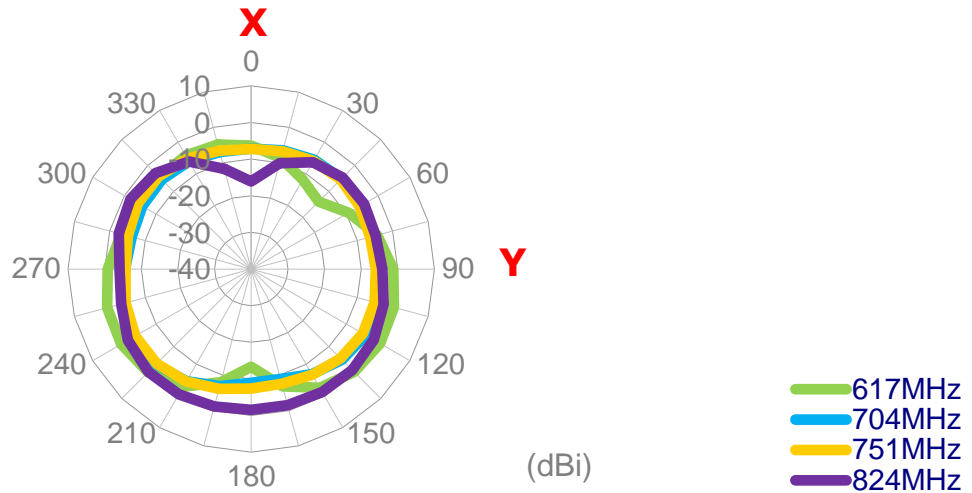

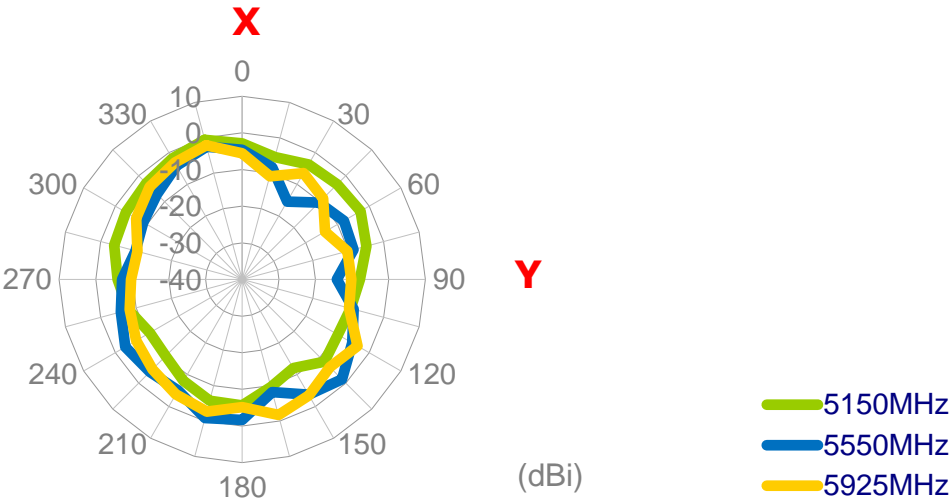
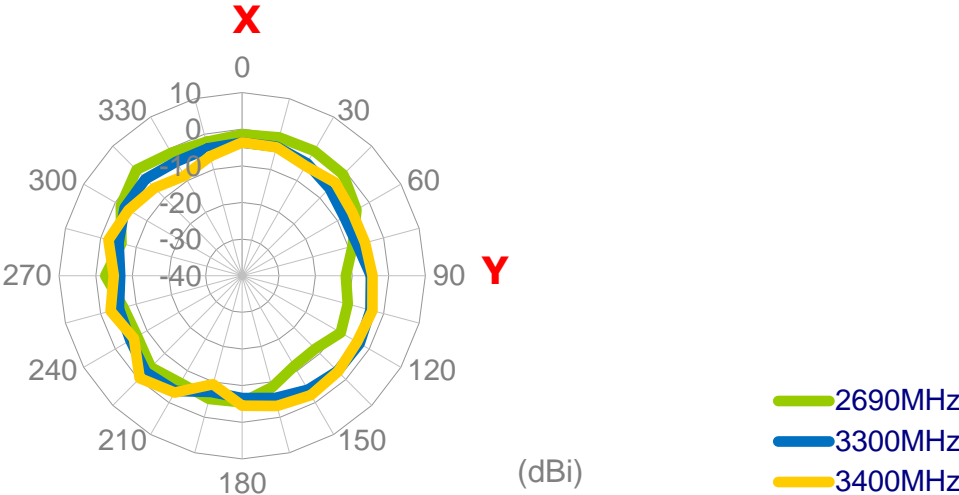

**XZ Plane**

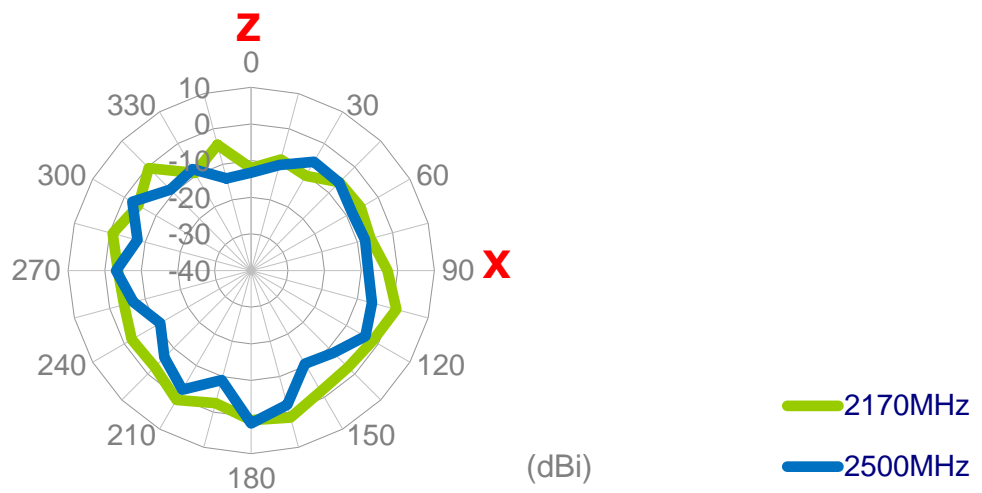
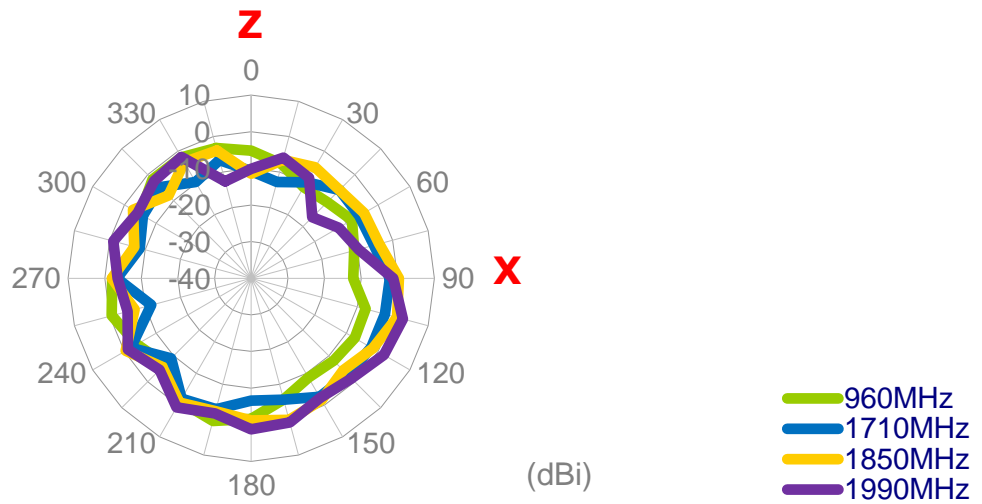
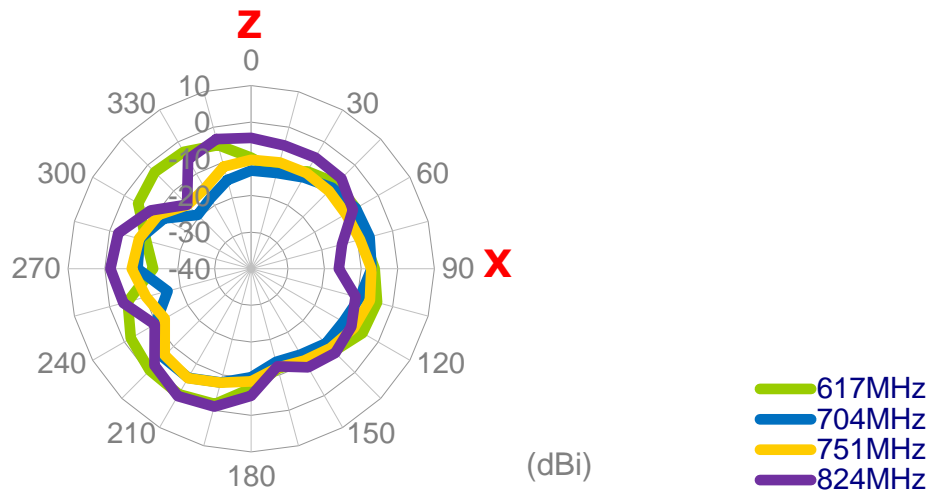



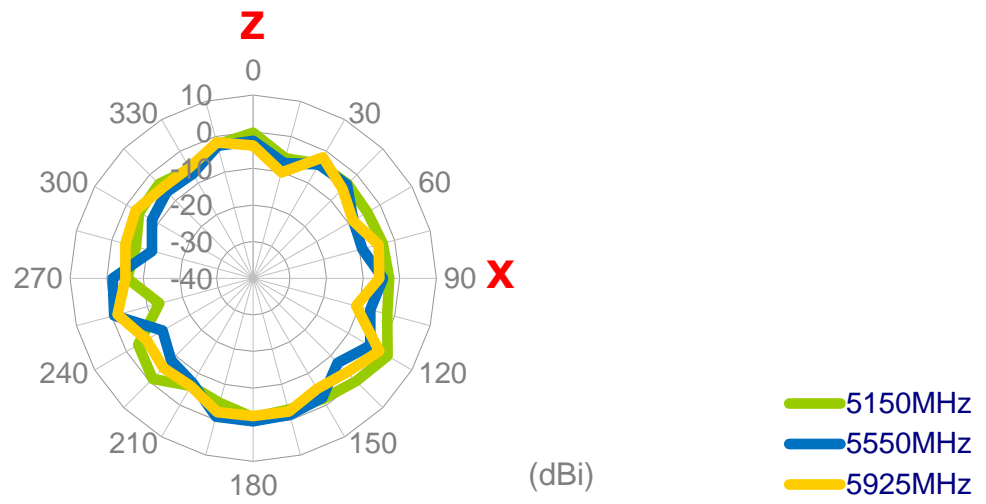
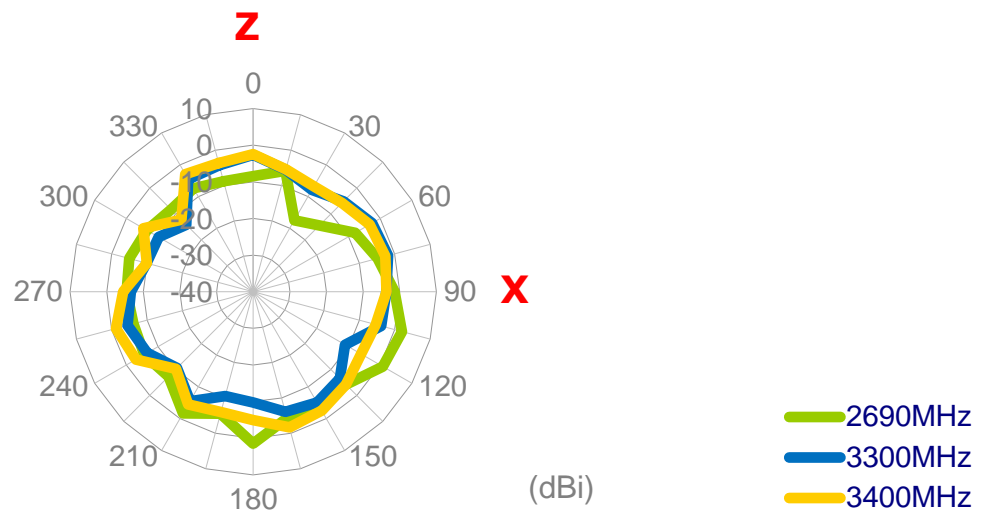

**YZ Plane**

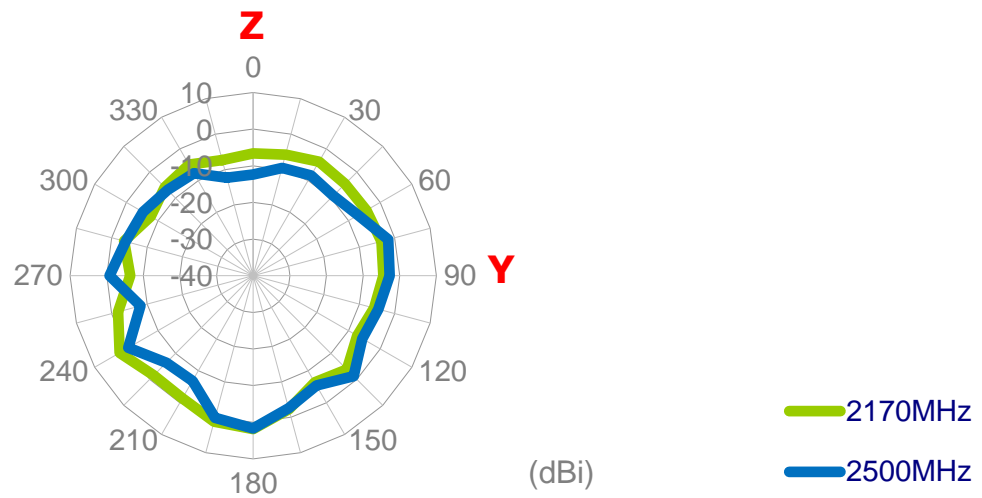
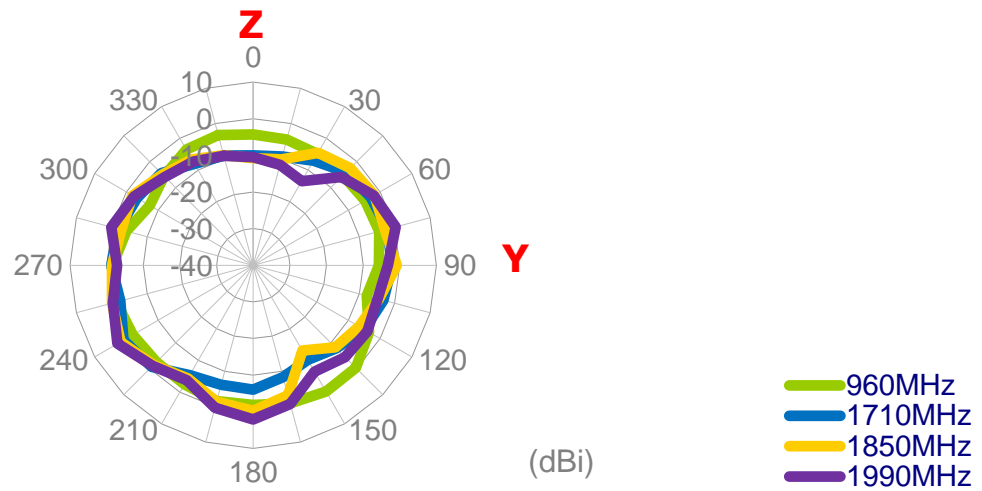
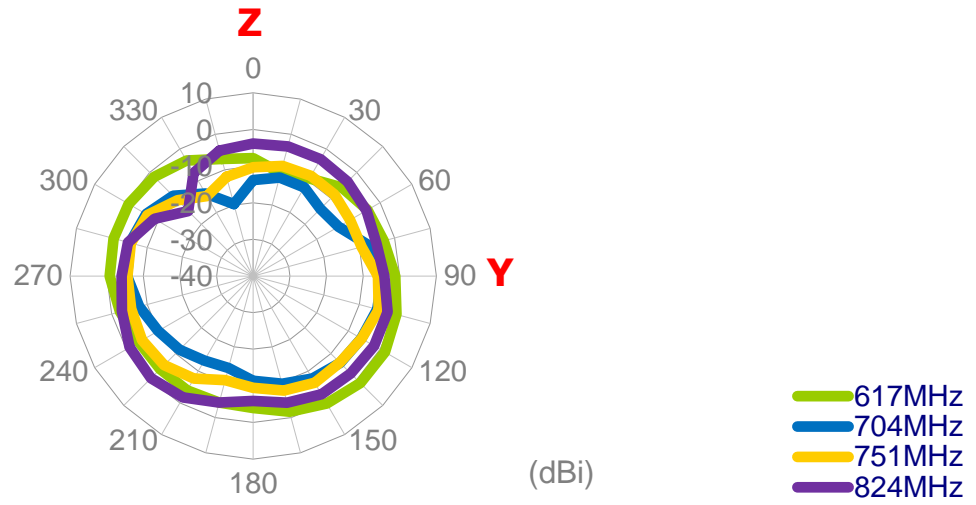

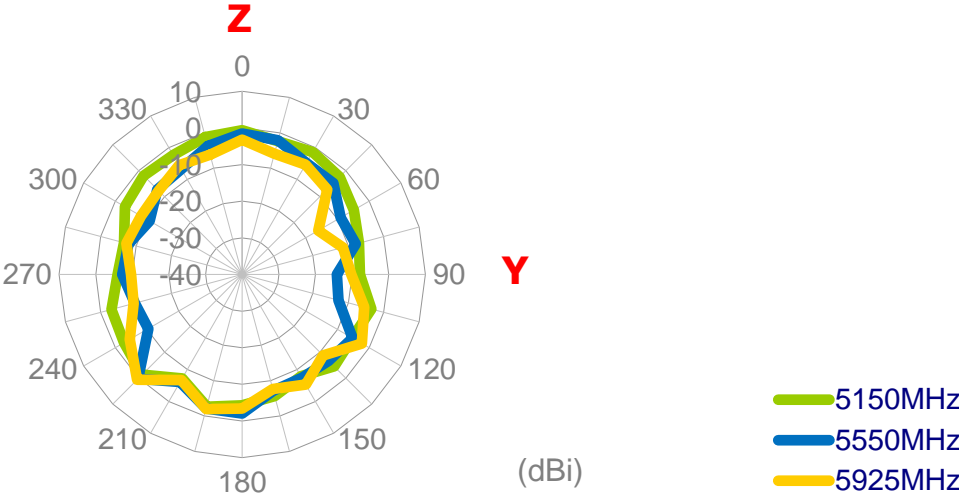
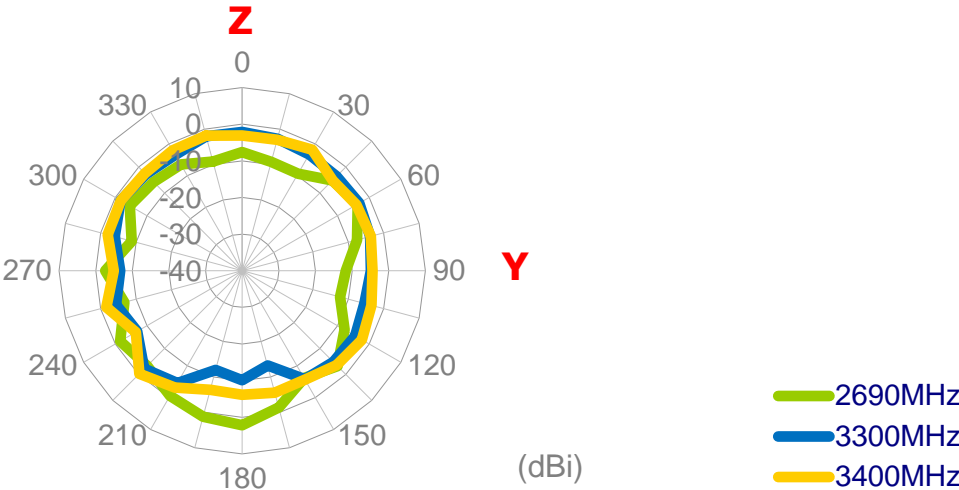

**4.2.2 LTE\_On 30x30cm GND**

**XY Plane**

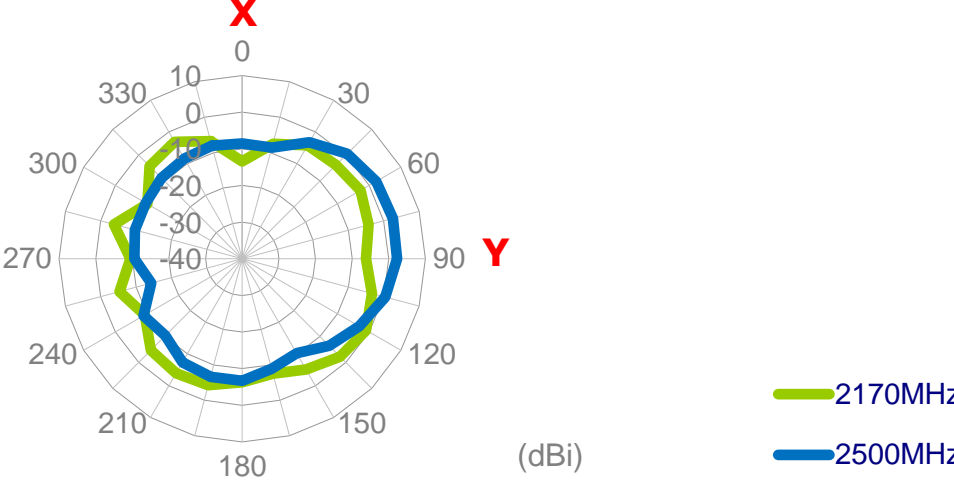
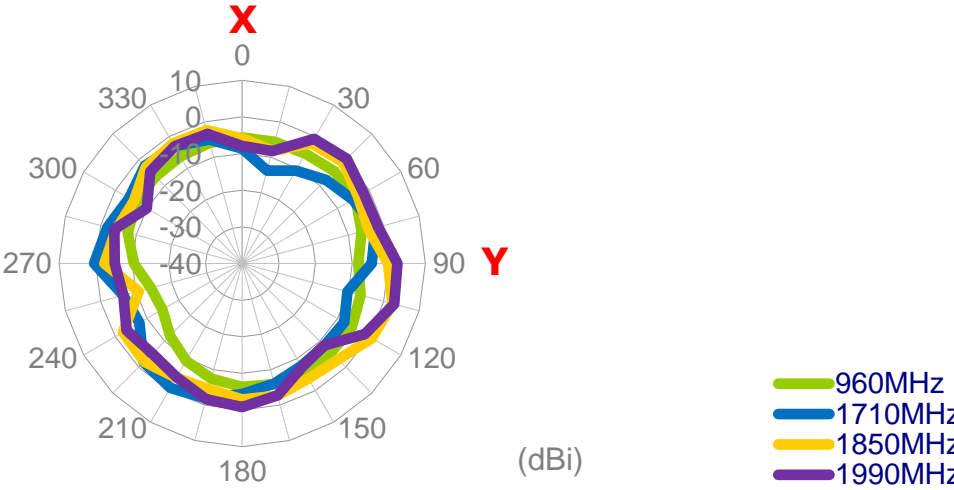
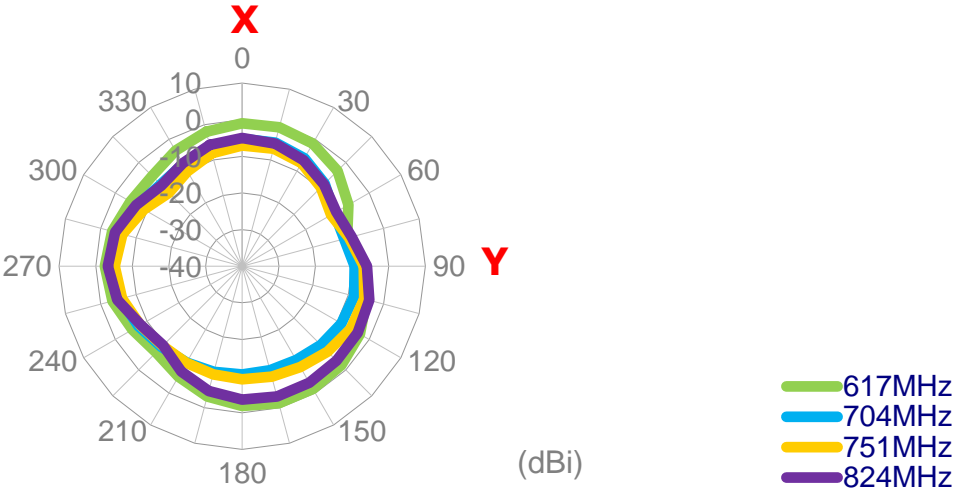

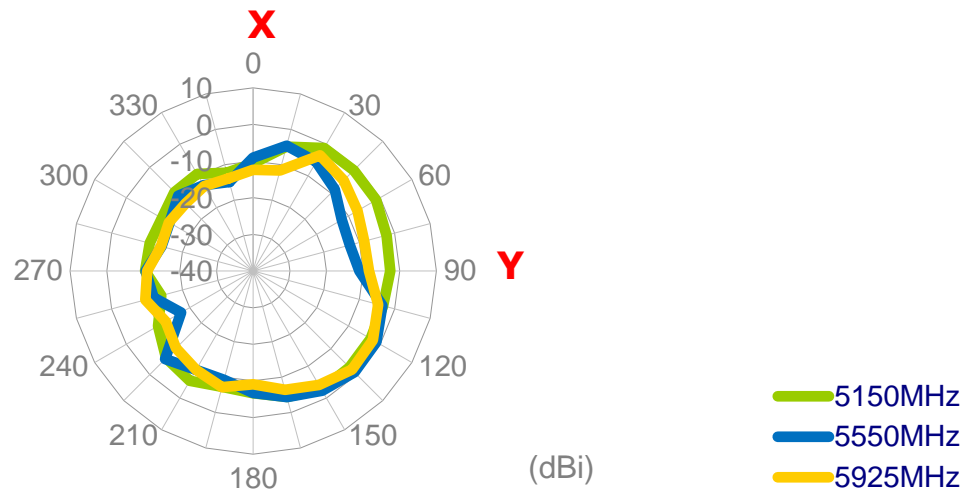
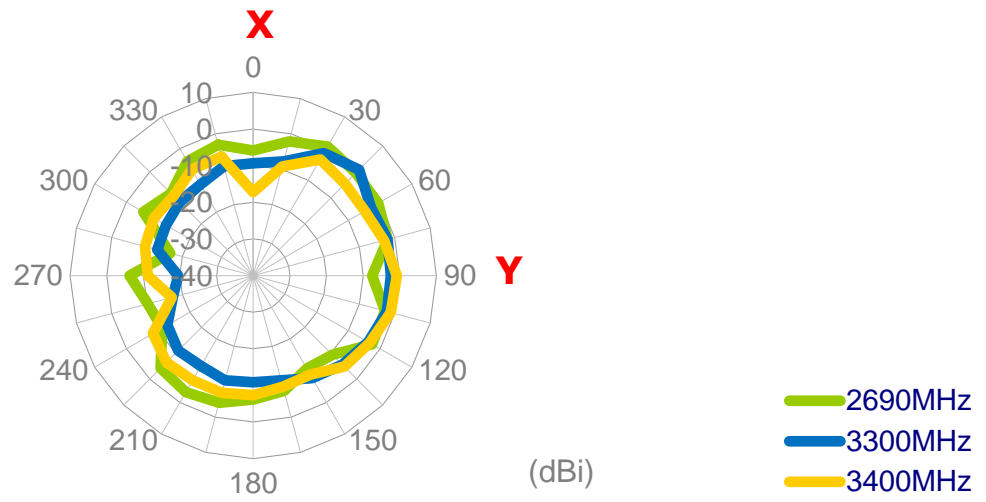

**XZ Plane**

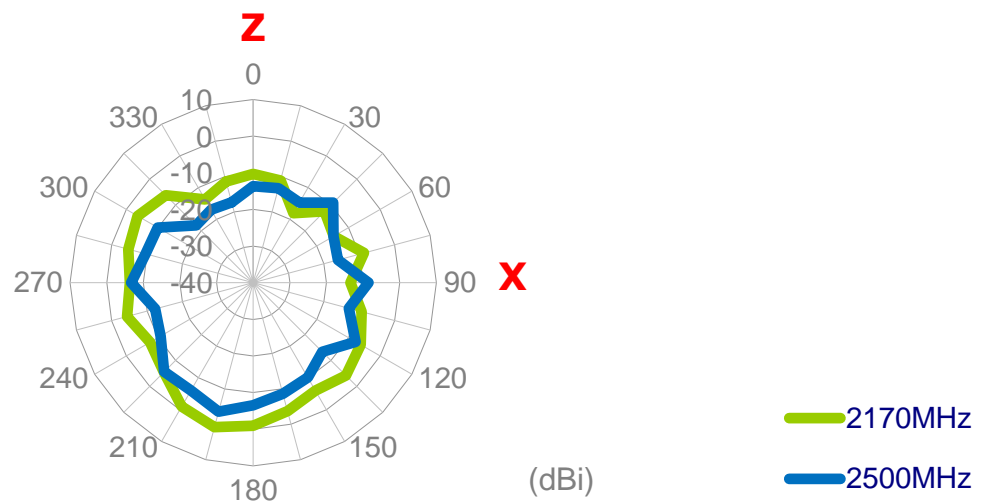
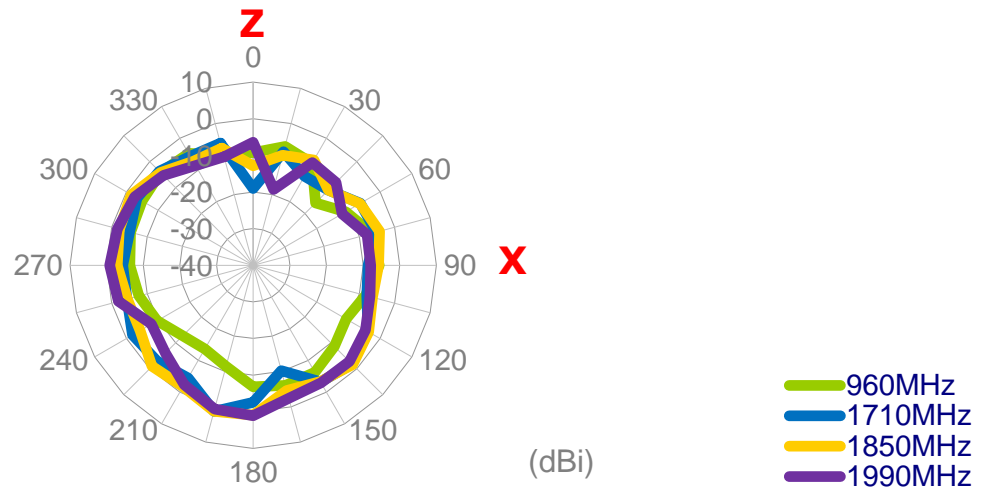
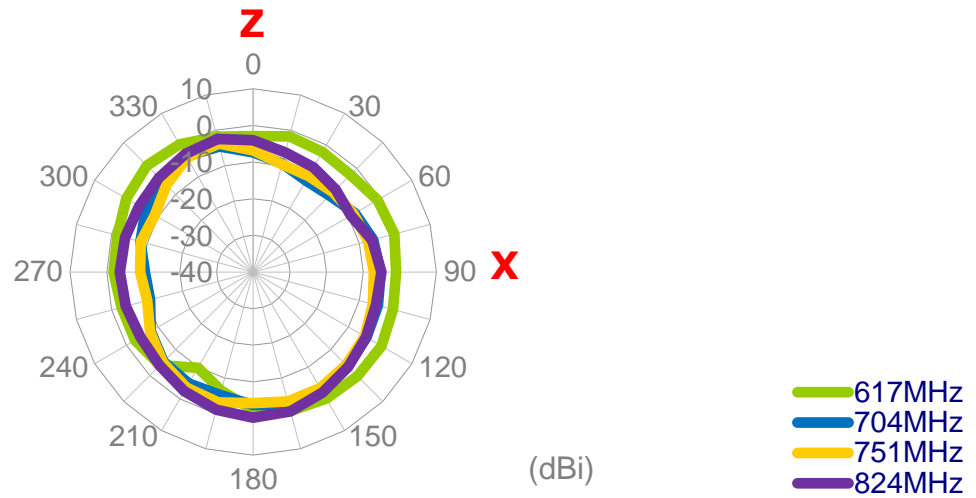

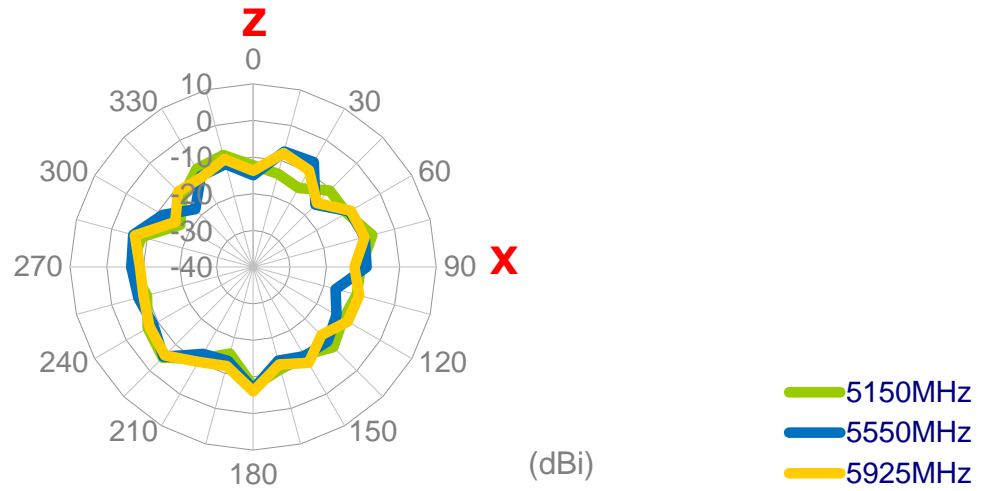
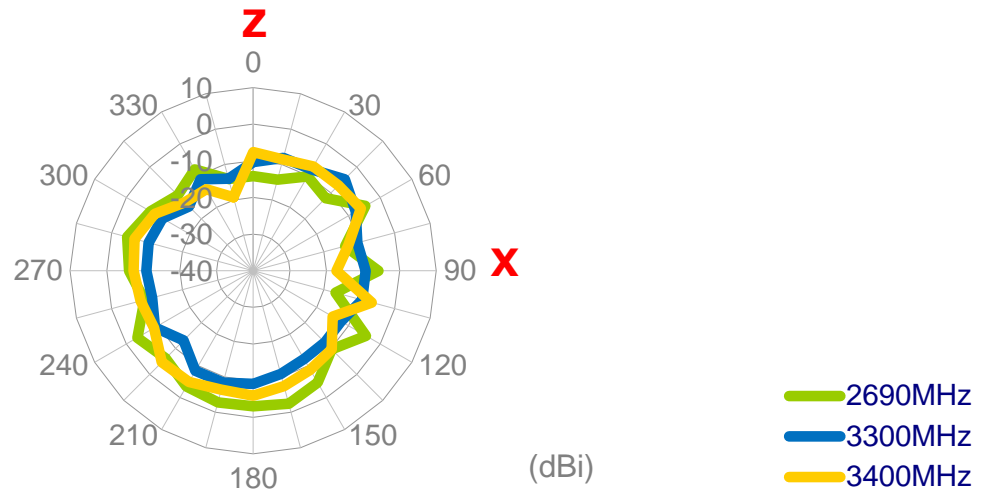

**YZ Plane**

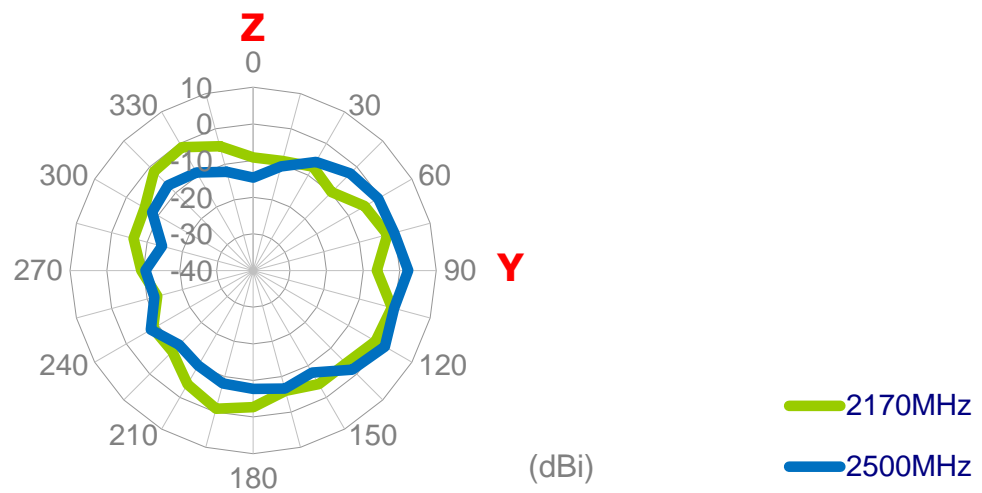
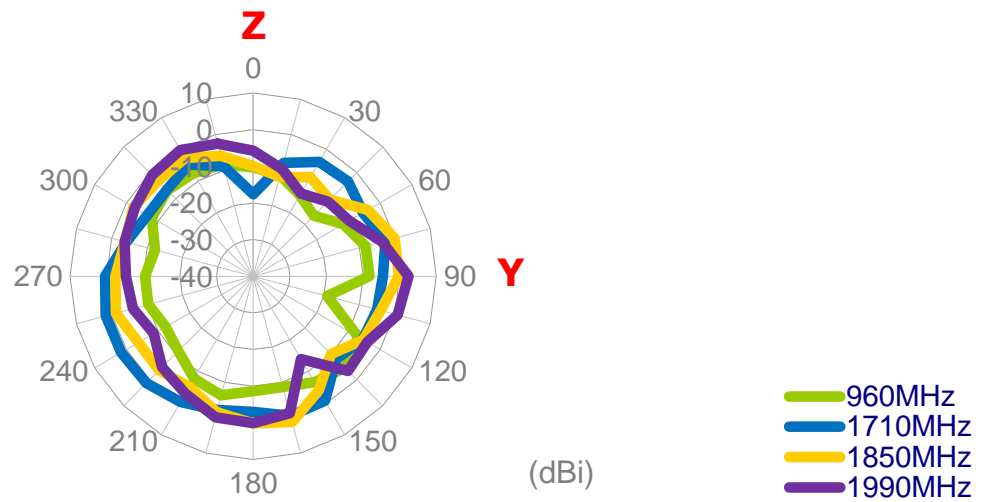
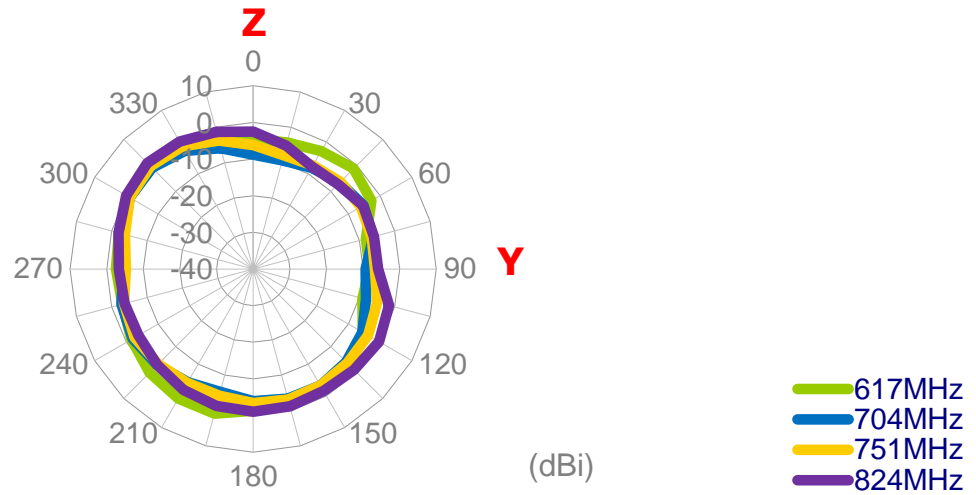



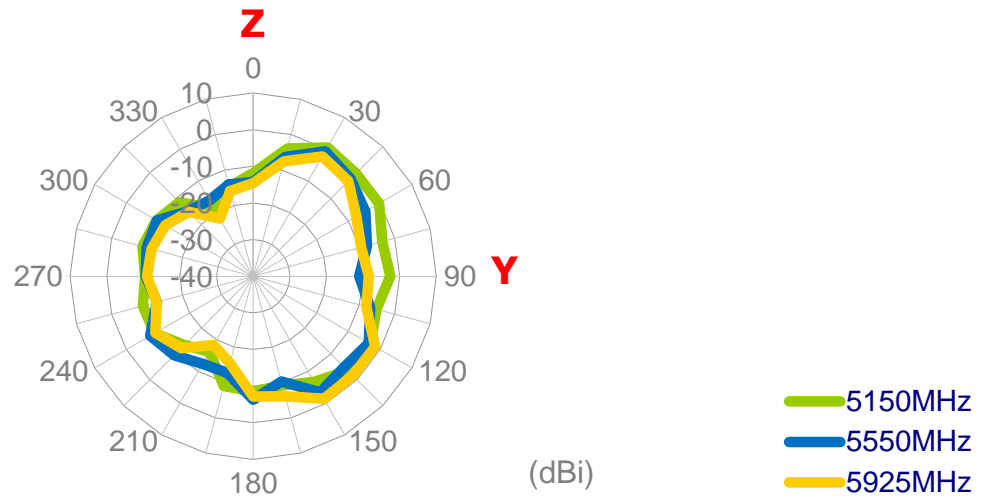
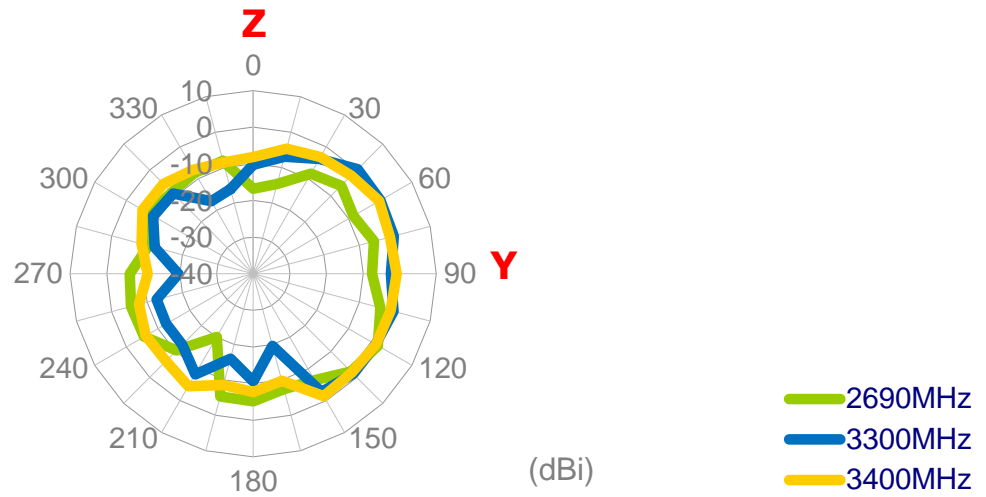

**4.2.3 GNSS**

**XY Plane**

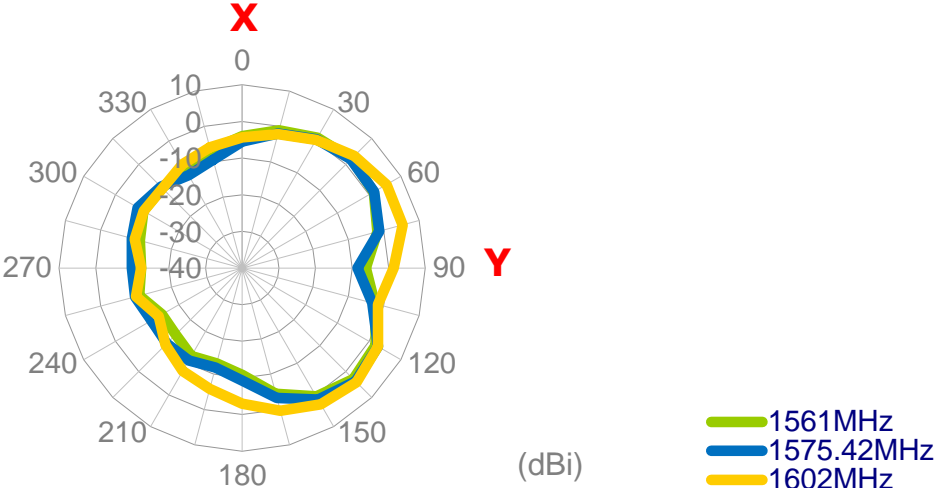

**XZ Plane**

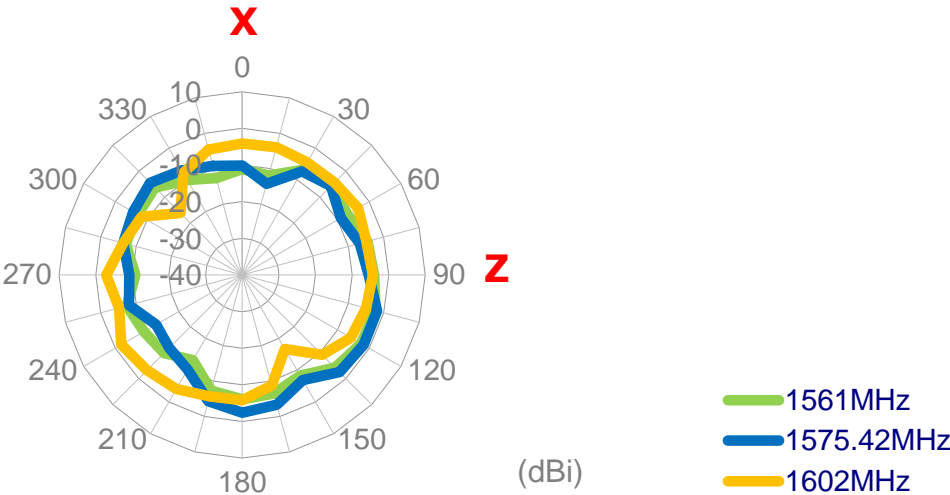

### YZ Plane

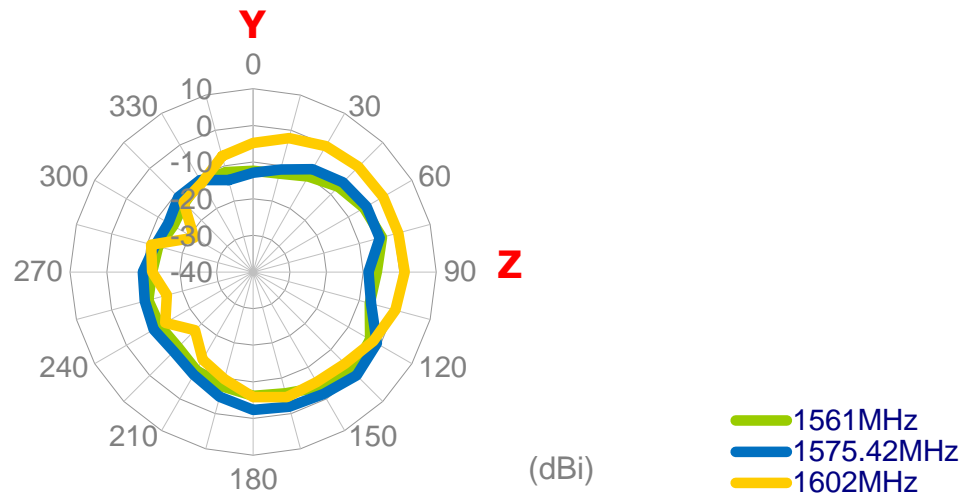

### 3D Radiation Patterns

#### 4.2.4 LTE

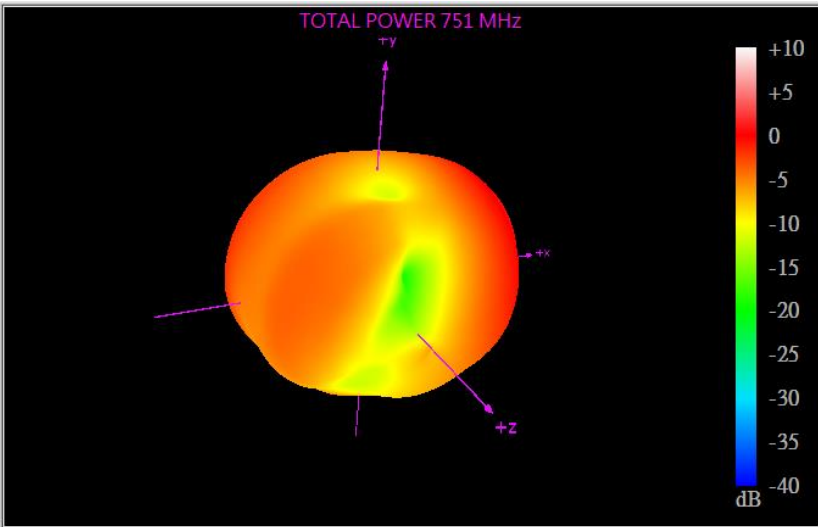
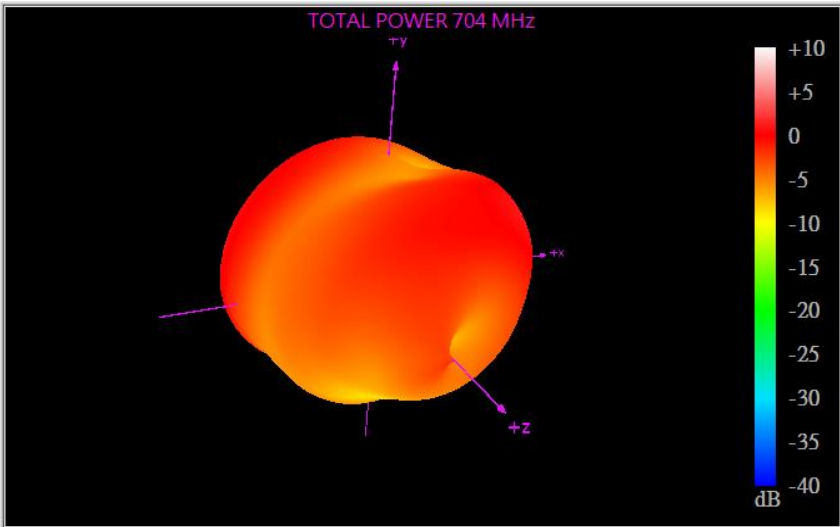
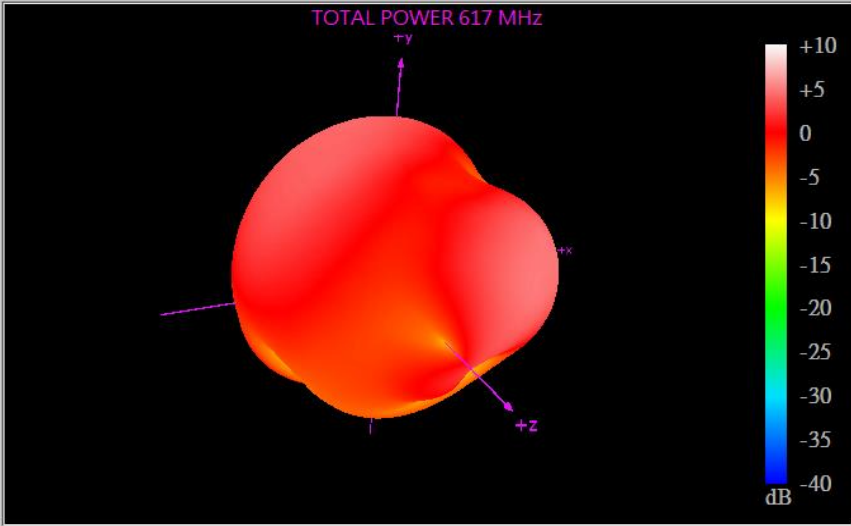

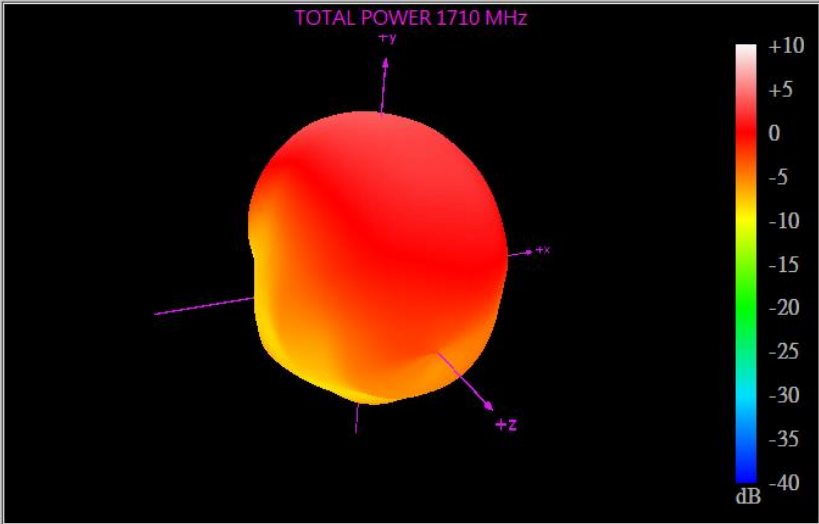
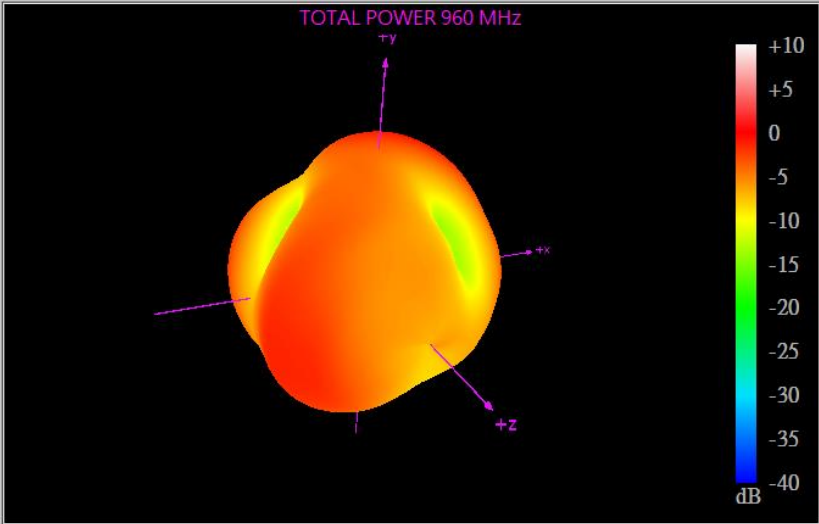
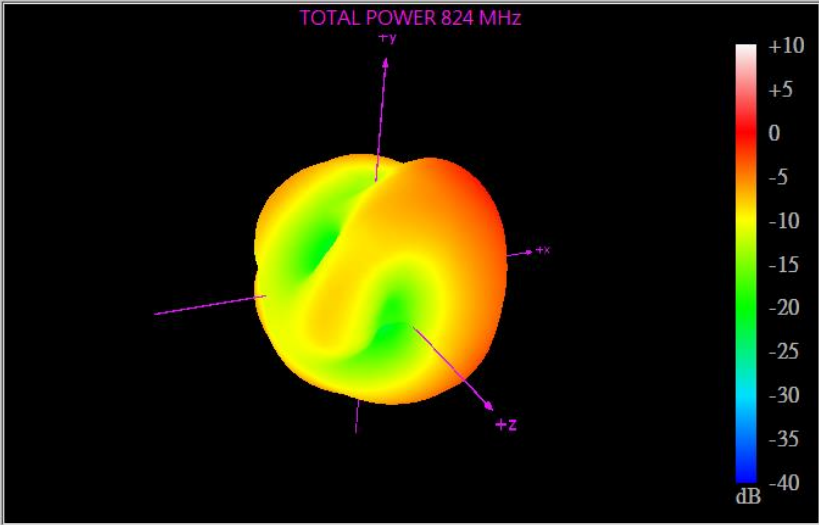

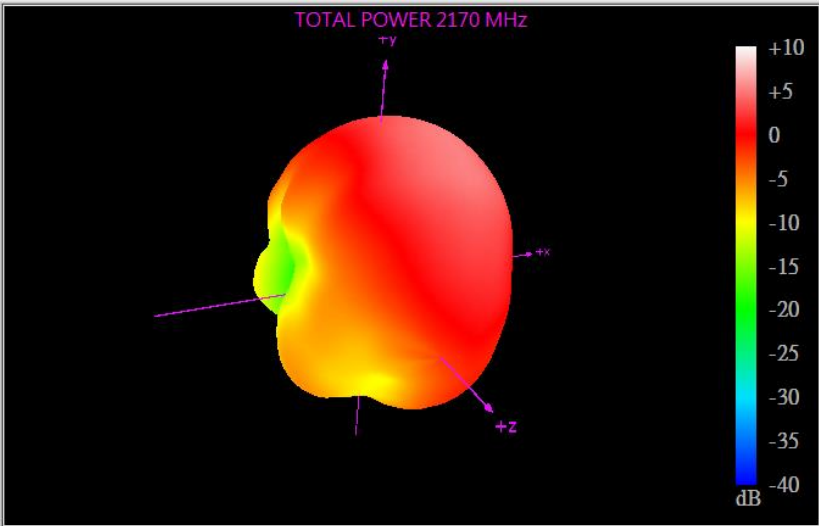
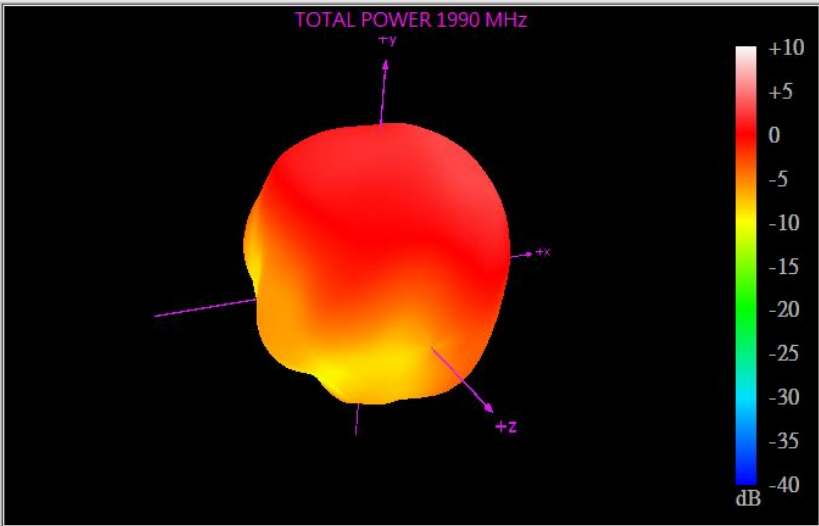
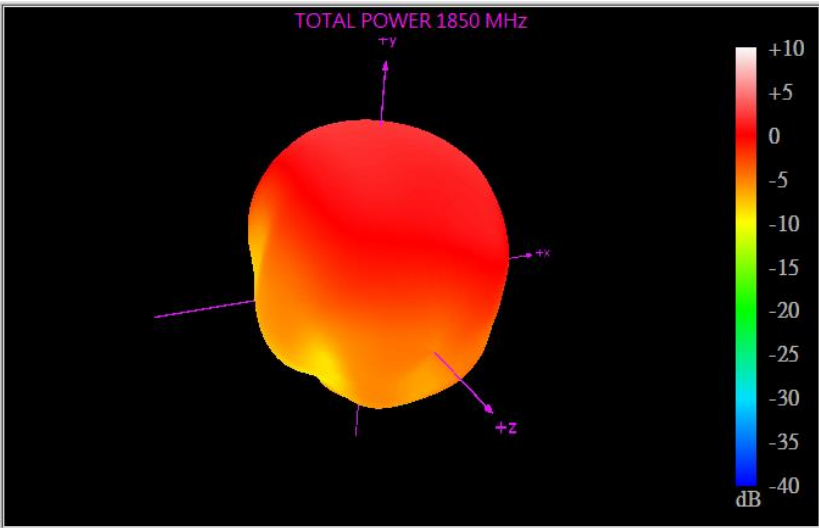

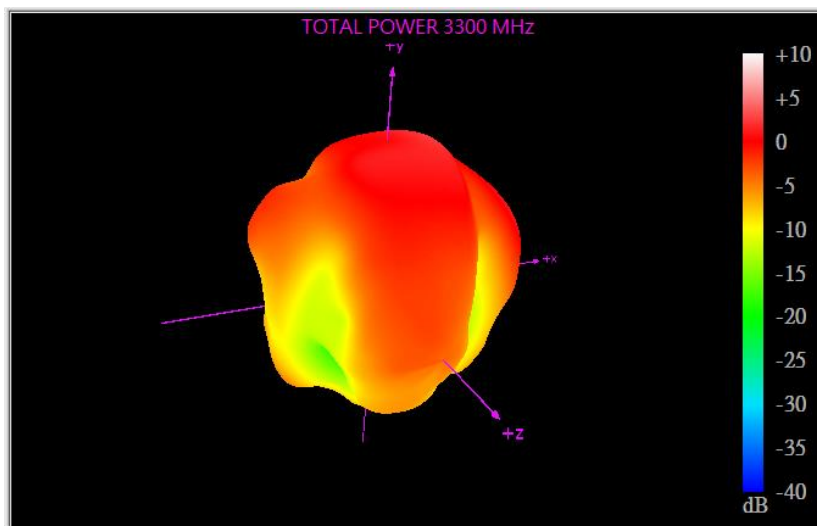
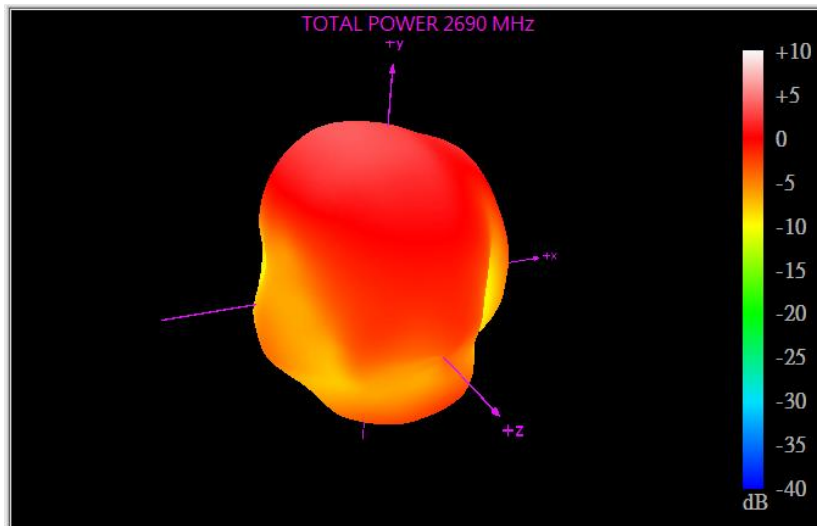
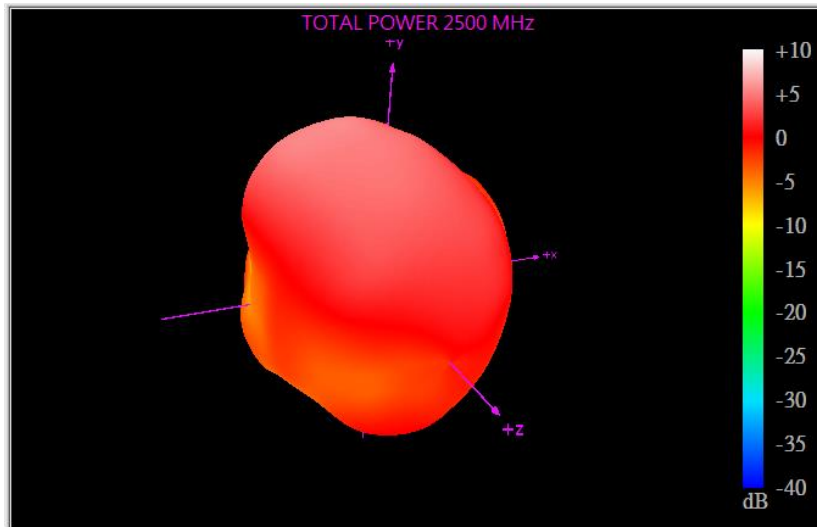

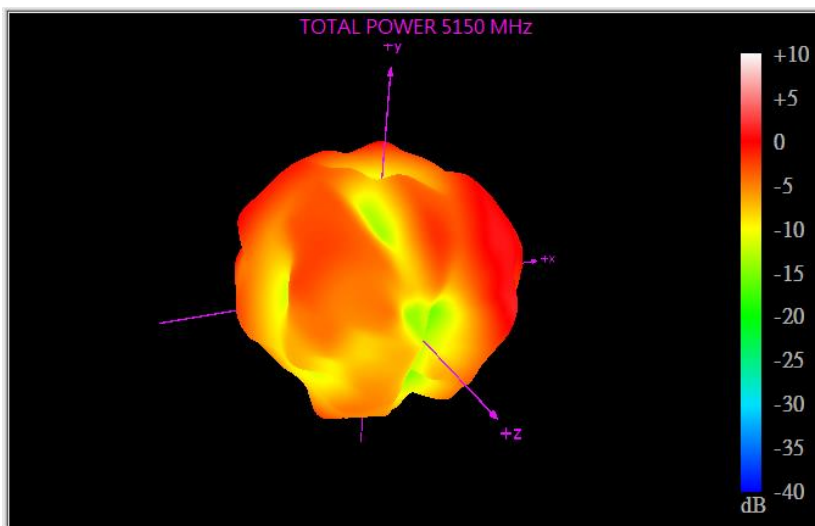
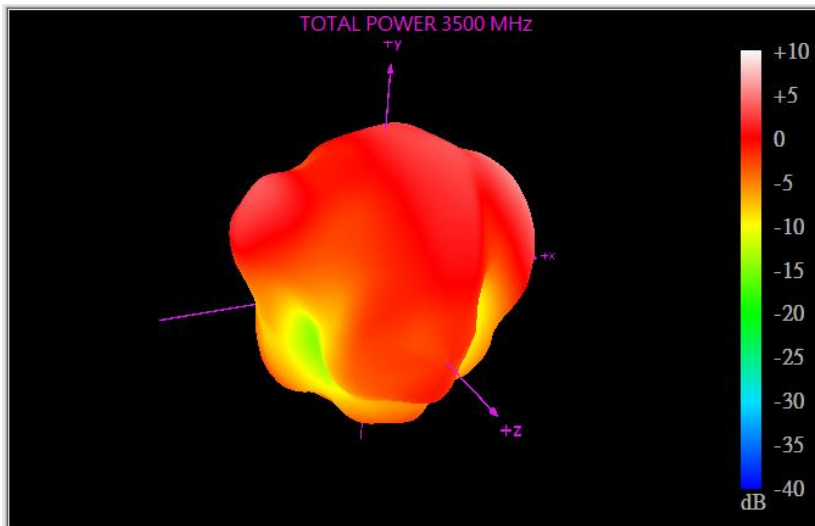
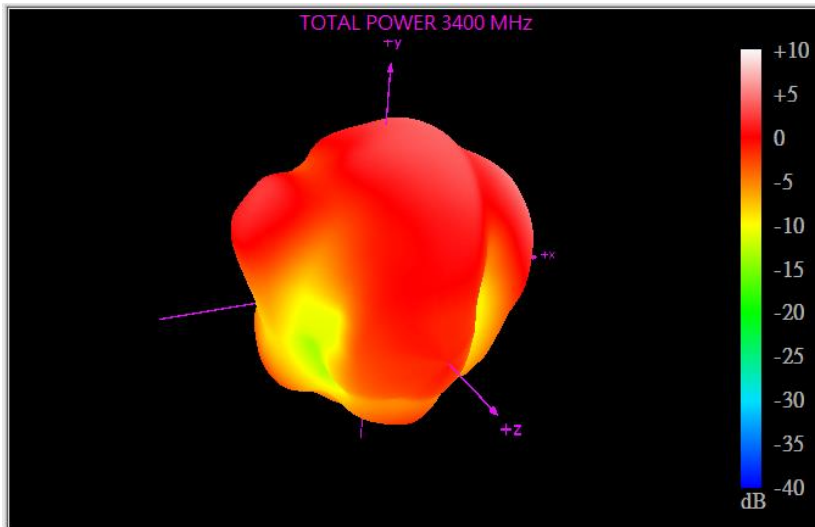



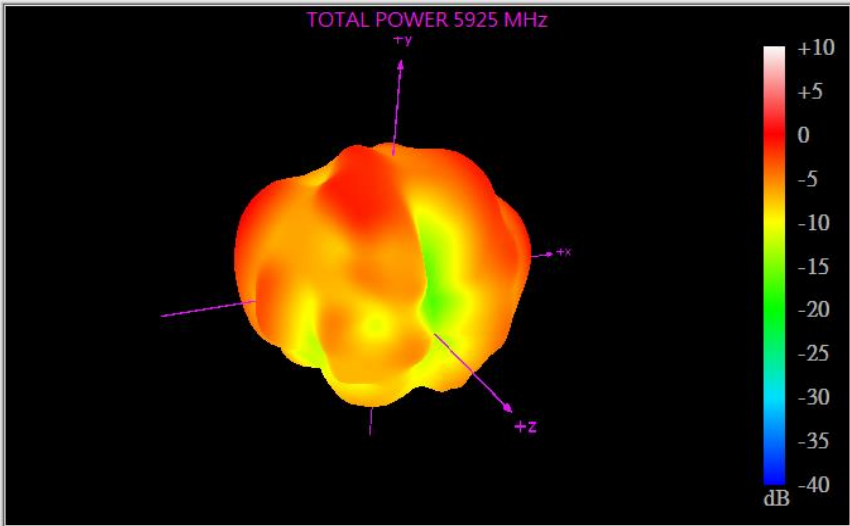
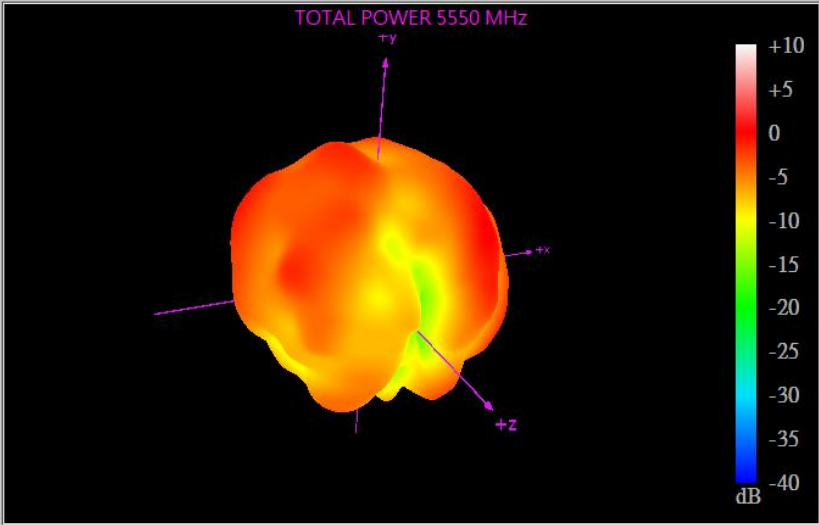

4.1.1 GNSS

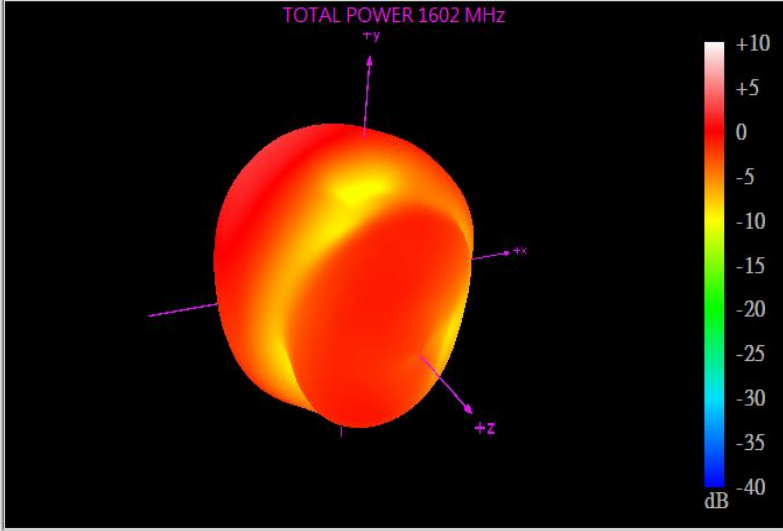
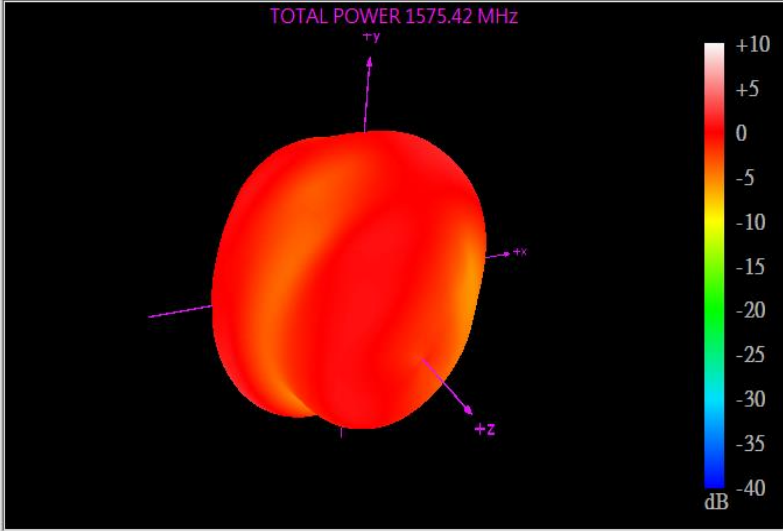
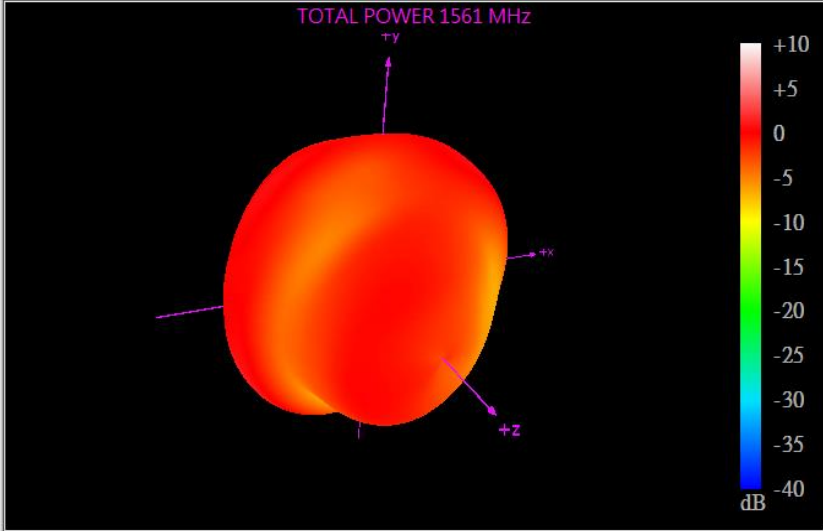

## 5. Mechanical Drawing (Unit: mm)

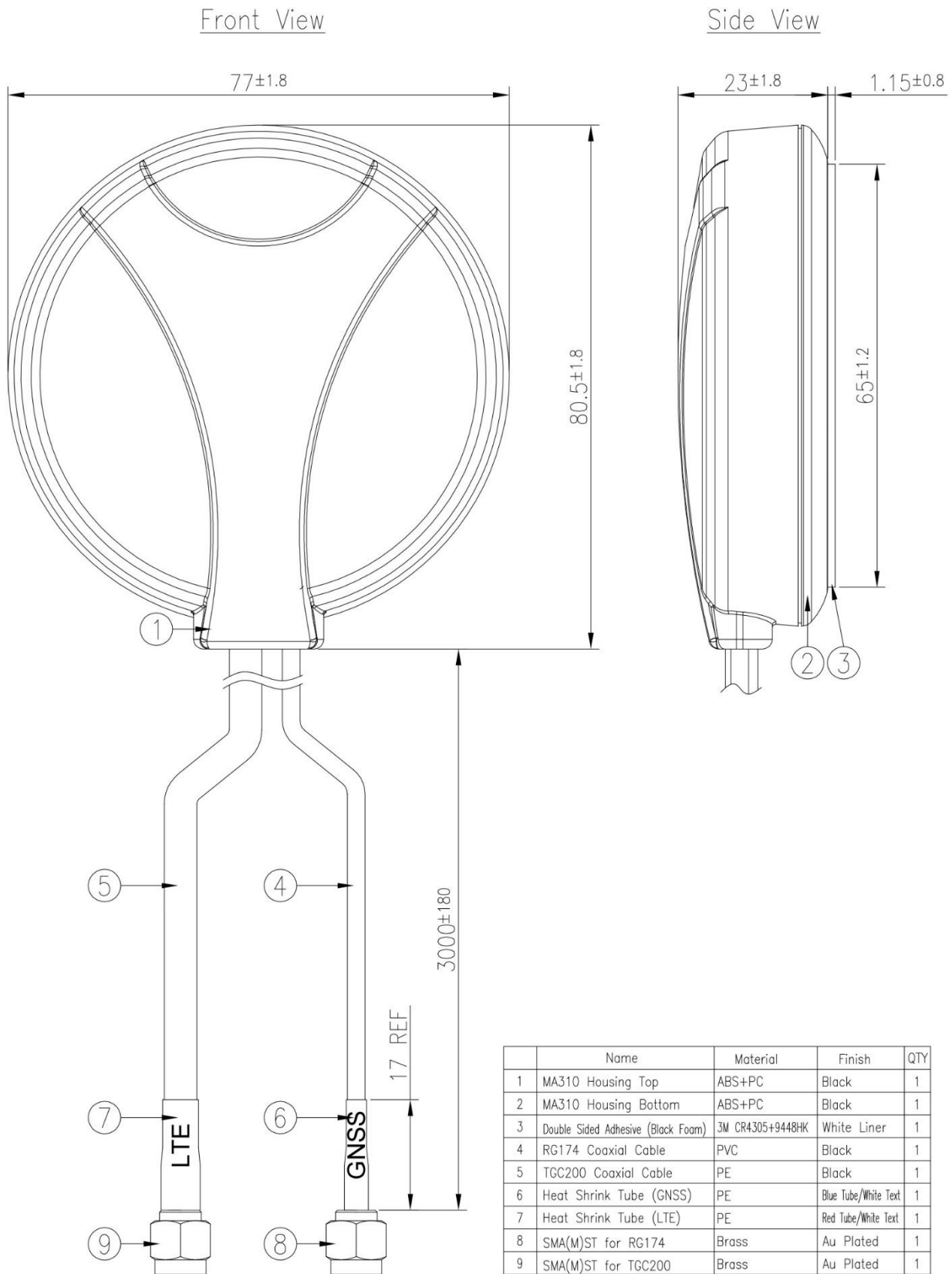

## 6. Packaging

Packaging has been requested, will update when received.

## 7. Application Note

The MA173.A.LBC.001 antenna performance with different cable lengths is shown below.

### 7.1. Return Loss

#### Return Loss – LTE Antenna (Free Space)

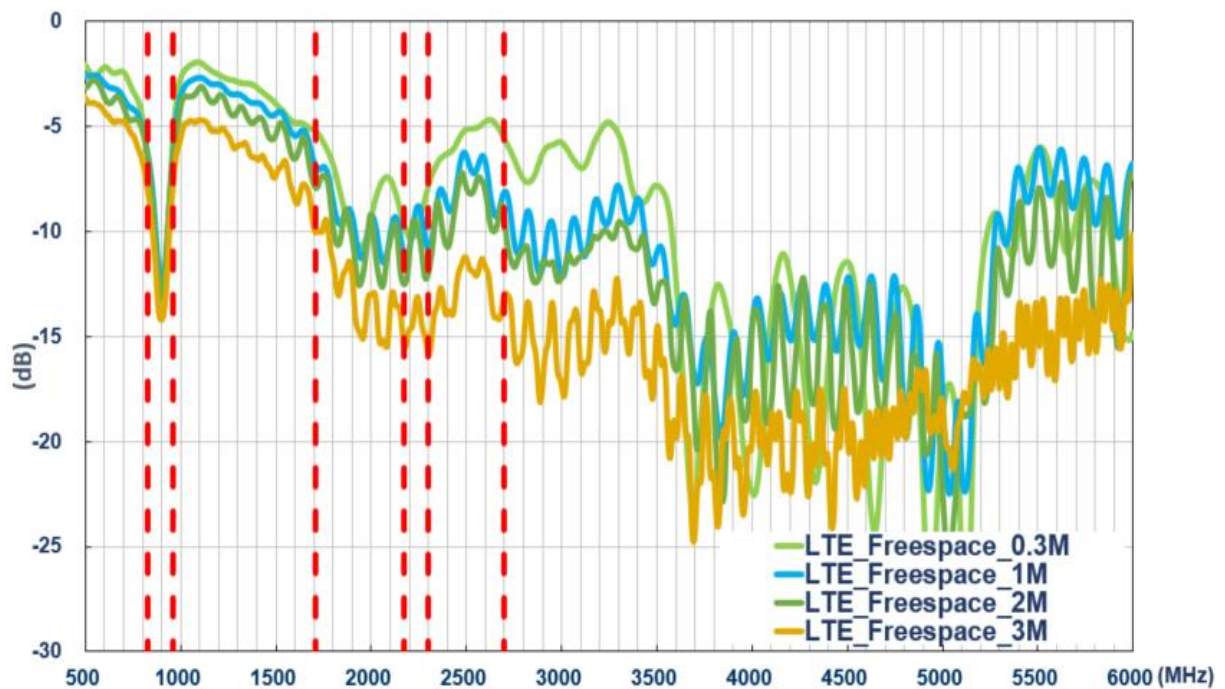

## Return Loss – LTE Antenna (On 30\*30cm GND)

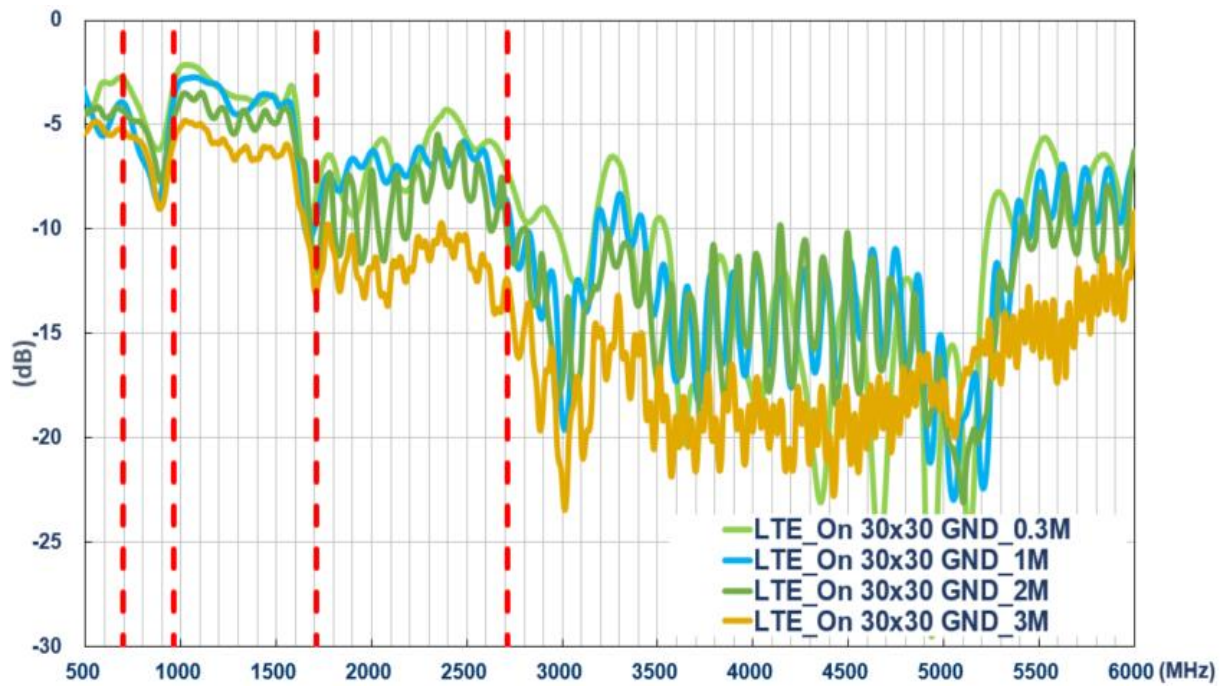

## 7.2. Efficiency

### Efficiency – LTE Antenna (Free Space)

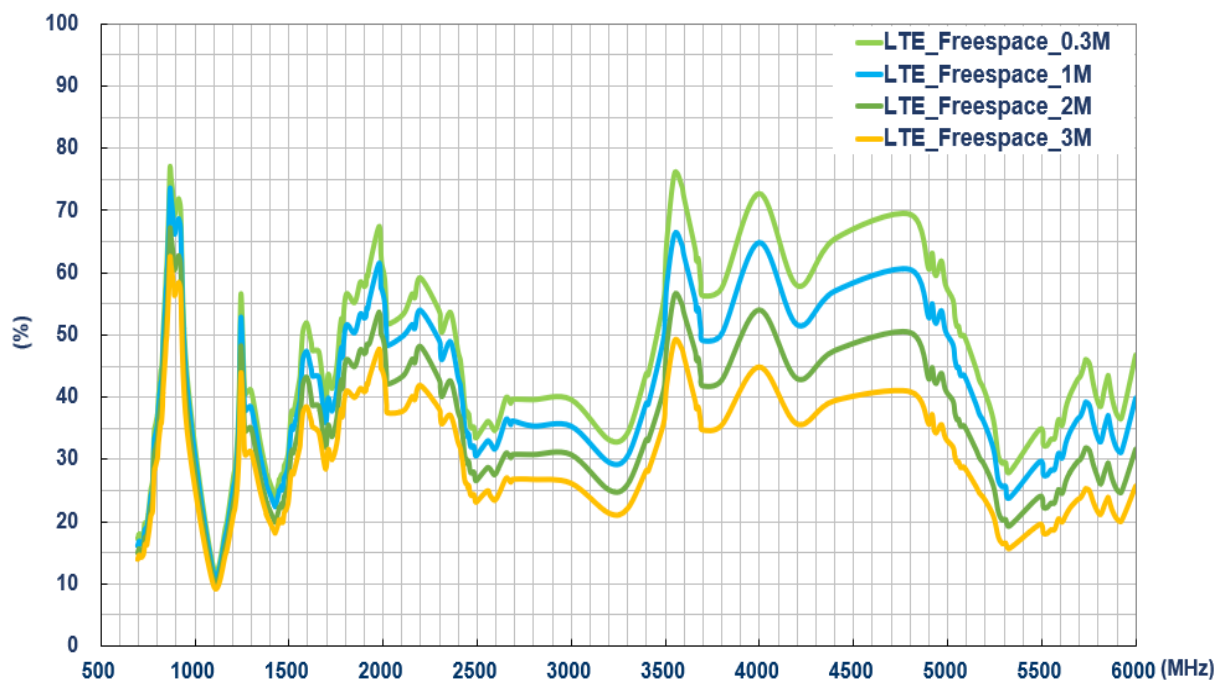

### Efficiency – LTE Antenna (On 30\*30 GND)

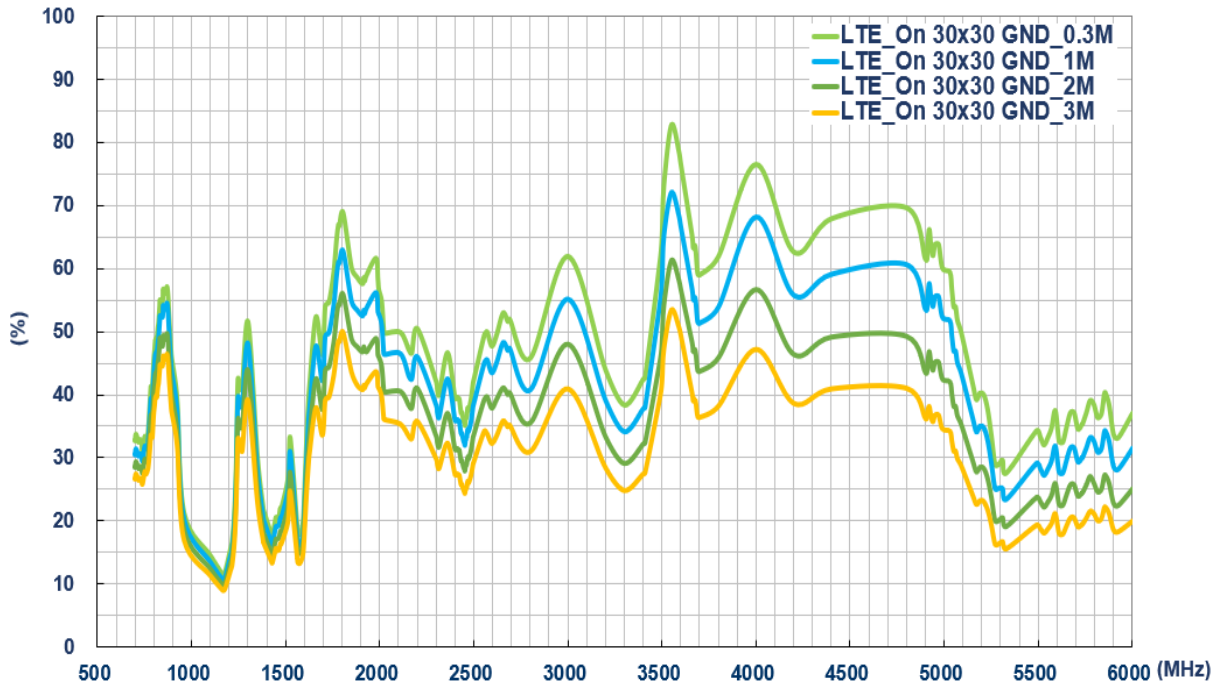

### 7.3. Average Gain

#### Average Gain – LTE Antenna (Free Space)

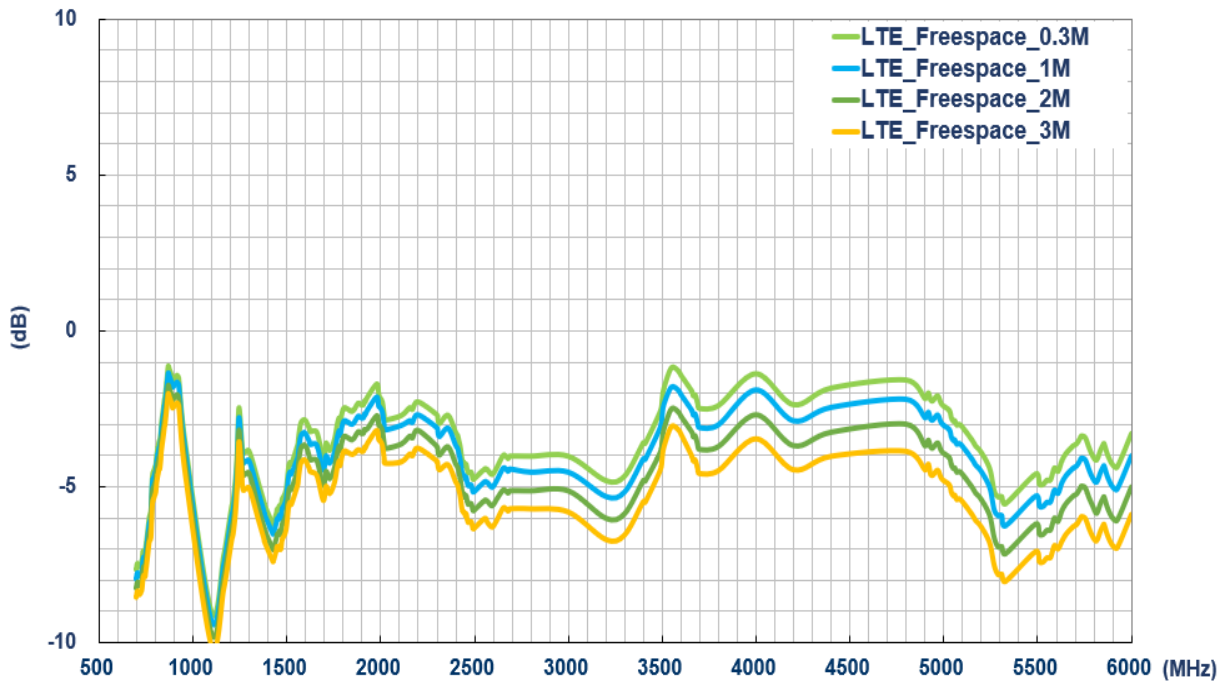

### Average Gain – LTE Antenna (On 30\*30cm GND)

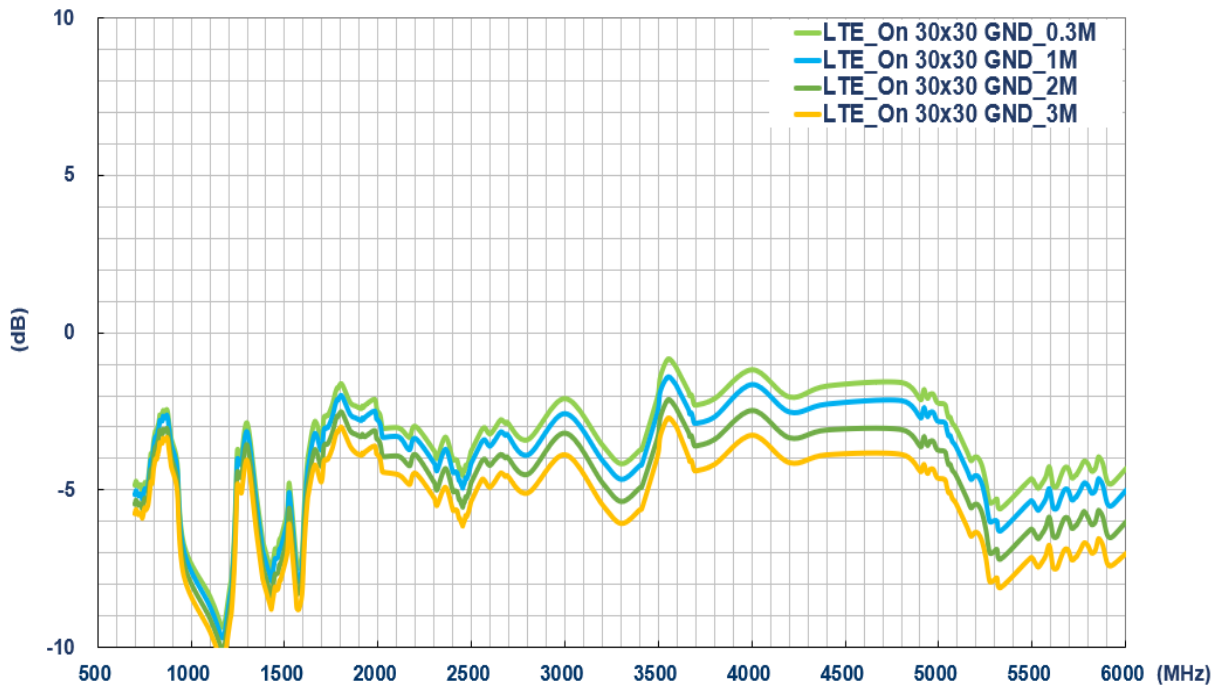

## 7.4. Peak Gain

### Peak Gain – LTE Antenna (Free Space)

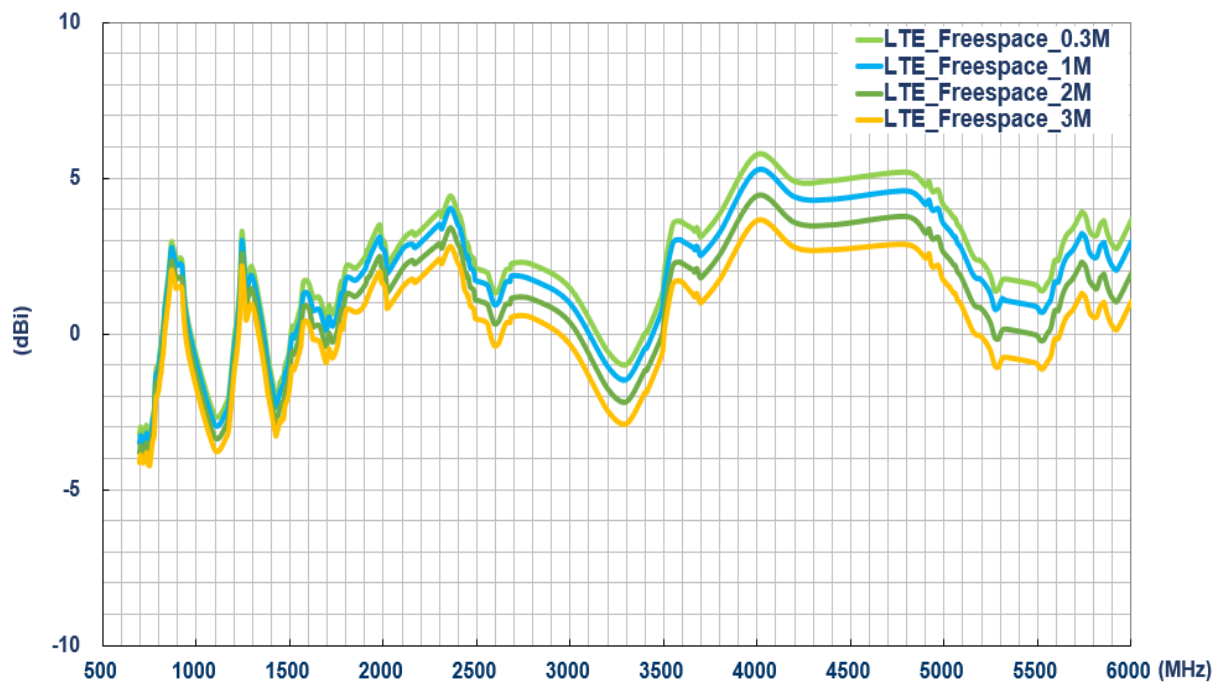



### Peak Gain – LTE Antenna (On 30\*30cm GND)

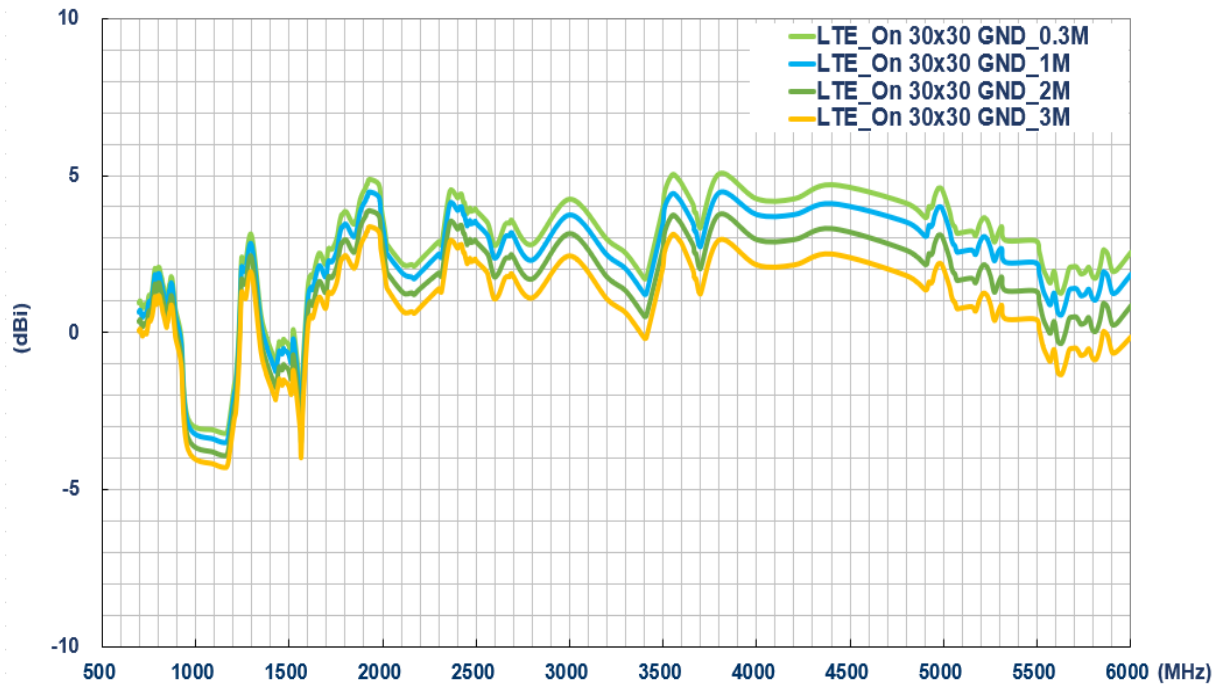

Taoglas makes no warranties based on the accuracy or completeness of the contents of this document and reserves the right to make changes to specifications and product descriptions at any time without notice. Taoglas reserves all rights to this document and the information contained herein.

Reproduction, use or disclosure to third parties without express permission is strictly prohibited.

Copyright © Taoglas Ltd.