

**Photoelectric sensor  
Laser scanning system  
LE550DQ**

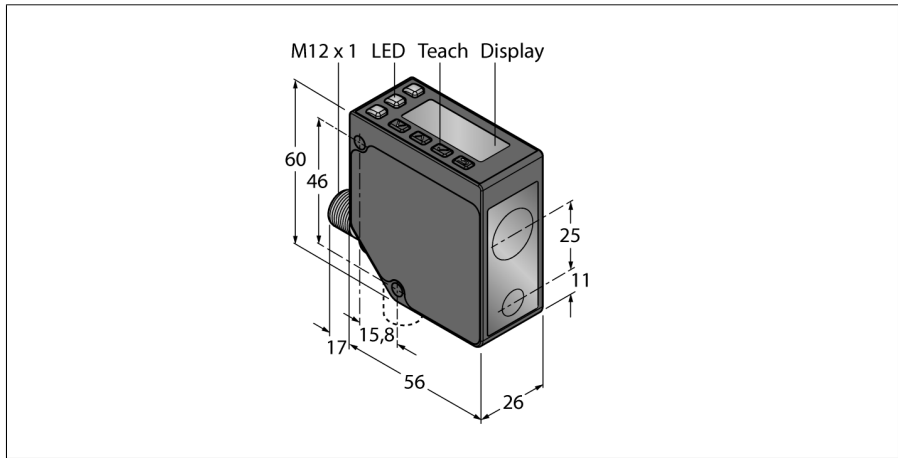

- 2-line 8-segment display
- Rotatable connector, male M12 x 1, 5-pin
- Range: 100...1000 mm
- Laser class 2, red, 650 nm, acc. to IEC 60825-1:2007
- Resolution at 100 mm - 600 mm distance: < 0.5 mm
- Resolution at 600 mm - 1000 mm distance: < 1 mm
- Operating voltage: 12...30 VDC
- Two switching outputs PNP/NPN configurable

<b>Type designation</b>	LE550DQ
Ident no.	3094196
<b>Operating mode</b>	Laser sensor, diffuse mode (triangulation)
Light type	red
Wavelength	650 nm
Laser class	▲ 2
Optical resolution	1 mm
Repeatability	0.5 mm
Range	100...1000 mm
Ambient temperature	-20...+55 °C
Ambient light immunity	> 10000 lux
<b>Operating voltage</b>	12...30 VDC
DC rated operational current	≤ 70 mA
Short-circuit protection	yes
Reverse polarity protection	yes
Output 2	Switching output
Switching frequency	≤ 250 Hz
Readiness delay	≤ 2 s
<b>Approvals</b>	CE, cULus listed
<b>Design</b>	Rectangular, LE550
Dimensions	56 mm x 26 mm x 77 mm
Housing material	Die-cast zinc, ZN, Black
Lens	plastic, polycarbonate
Electrical connection	Connector, M12 (↶) 1
Protection class	IP67
<b>Special features</b>	Synchronization
Power-on indication	LED green
Switching state	LED yellow

**Wiring Diagram**

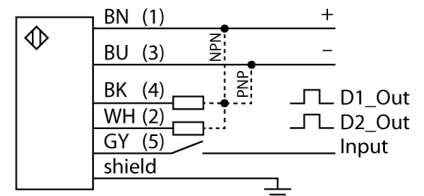

**Functional principle**

The LE550 laser sensors measure the distance to an object up to a range of 1 m. The settings are made via buttons at the housing. The built-in display assists with the menu navigation and is used to display the measured distance. The switching output is re-programmable and the analog output is, depending on the type, either laid out as current or voltage output. The integrated connector is rotatable by 90° degrees which makes it easy to mount. The transmitter LED can be turned off via the menu or the grey wire (PIN 5). The same wire can be used to operate two devices in the synch mode, which prevents mutual influence. The measurement achieves an accuracy of 0.5 mm at a distance of max. 600 mm.

**Excess Gain Curve**

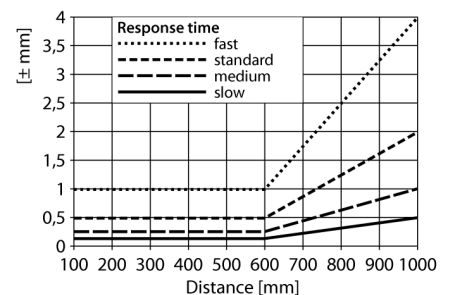

**Photoelectric sensor  
Laser scanning system  
LE550DQ**

**TURCK**

Industrial  
Automation

**Accessories**

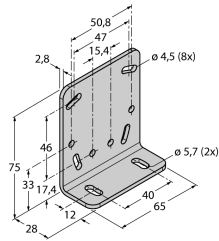
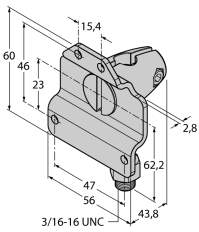
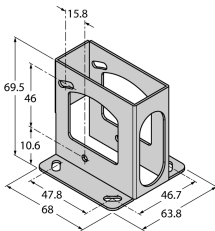
Type code	Ident no.	Description	
SMBLEL	3086754	Mounting bracket, rectangular, stainless steel, for side mounting of LE250/550 sensors	
SMBLEFA	3088226	Mounting bracket, rotatable, stainless steel, for sensors of the LE250/550 series	
SMBLEU	3086755	Protective housing, stainless steel, for sensors of the LE250/550 series	

**Wiring accessories**

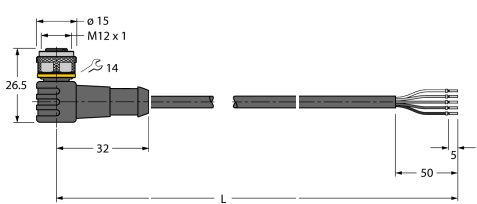
Type code	Ident no.	Description	
RKC4.5T-2/TEL	6625016	Connection cable, female M12, straight, 5-pin, cable length: 2 m, sheath material: PVC, black; cULus approval; other cable lengths and qualities available, see <a href="http://www.turck.com">www.turck.com</a>	
WKC4.5T-2/TEL	6625028	Connection cable, female M12, angled, 5-pin, cable length: 2 m, sheath material: PVC, black; cULus approval; other cable lengths and qualities available, see <a href="http://www.turck.com">www.turck.com</a>	

Photoelectric sensor  
Laser scanning system  
LE550DQ

**TURCK**

Industrial  
Automation

Wiring accessories

Type code	Ident no.	Description	
RKS4.5T-2/TEL	6626361	Connection cable, M12 female connector, straight, 5-pin, cable length: 2 m, sheath material: PVC, black; shielded; cULus approval; other cable lengths and qualities available, see <a href="http://www.turck.com">www.turck.com</a>	
WKS4.5T-2/TEL	6626364	Connection cable, M12 female connector, angled, 5-pin, cable length: 2 m, sheath material: PVC, black; shielded; cULus approval; other cable lengths and qualities available, see <a href="http://www.turck.com">www.turck.com</a>	