

# AAMD-CM33-Z1x02, AAMD-CB33-STx02

## Mini High Brightness SMT Round Lamps

---

### Overview

The Broadcom<sup>®</sup> AAMD series is a mini version of the AEMD-Cxxx series of LEDs. The smaller package size of the AAMD series enables the design of displays with a tighter pitch. These LEDs are essentially like conventional high brightness through-hole LEDs in the form of surface-mount devices. They can be assembled using common SMT assembly processes and are compatible with an industrial reflow soldering process.

The LEDs are made with an advanced optical grade epoxy for superior performance in outdoor sign applications. For easy pick-and-place assembly, the LEDs are shipped in tape and reel. Every reel is shipped from a single intensity and color bin for better uniformity.

### Features

- Smaller package size
- Available in green and blue
- Typical viewing angle: 34°
- Tinted and diffused appearance
- MSL 3

### Applications

- Full-color variable message signs

#### **CAUTION!**

This LED is ESD sensitive. Please observe appropriate precautions during handling and processing. Refer to application note AN-1142 for additional details.

The LED must be kept in a moisture barrier bag with < 5% relative humidity (RH) when not in use because prolonged exposure to the environment might cause the leads to tarnish or rust, which might cause difficulties in soldering.

Figure 1: Package Drawing

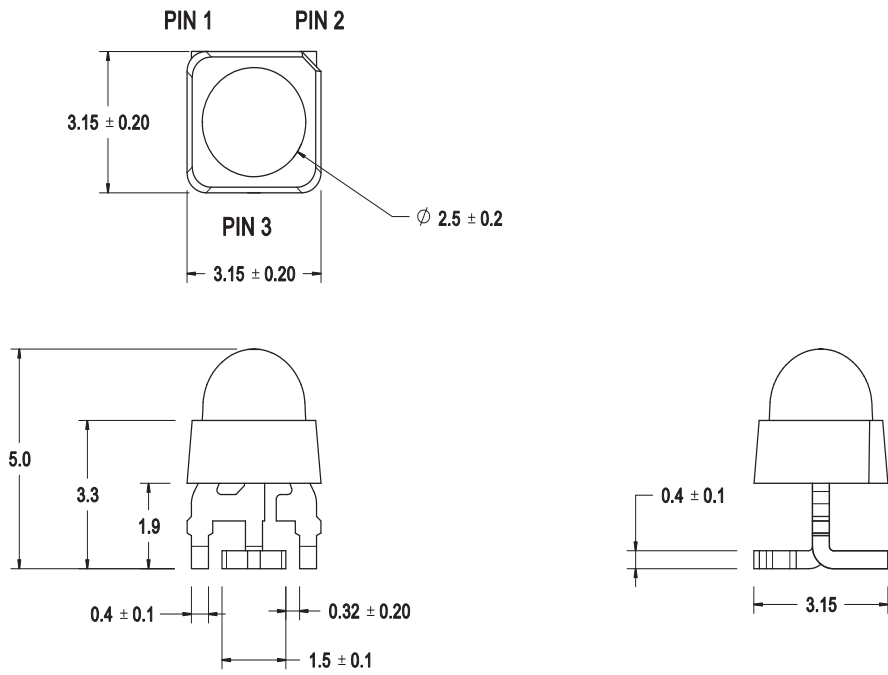

Lead Configuration	
Pin 1	Anode
Pin 2	Cathode
Pin 3	Anode

**NOTE:**

1. All dimensions are in millimeters (mm).
2. Tolerance is  $\pm 0.50$  mm unless otherwise specified.

## Device Selection Guide ( $T_J = 25^\circ\text{C}$ , $I_F = 20\text{ mA}$ )

Part Number	Color	Luminous Intensity, $I_V$ (mcd) <sup>a, b</sup>		Dominant Wavelength, $\lambda_d$ (nm) <sup>c</sup>	
		Min.	Max.	Min.	Max.
AAMD-CM33-Z1002	Green	12000	21000	519.0	539.0
AAMD-CM33-Z1B02	Green	12000	21000	523.0	531.0
AAMD-CM33-Z1C02	Green	12000	21000	527.0	535.0
AAMD-CB33-ST002	Blue	1900	3200	460.0	480.0
AAMD-CB33-STB02	Blue	1900	3200	464.0	472.0
AAMD-CB33-STC02	Blue	1900	3200	468.0	476.0

- The luminous intensity,  $I_V$ , is measured at the mechanical axis of the package and it is tested with a single current pulse condition. The actual peak of the spatial radiation pattern may not be aligned with the axis.
- Tolerance is  $\pm 15\%$ .
- The dominant wavelength,  $\lambda_d$ , is derived from the CIE Chromaticity Diagram and represents the perceived color of the device.

## Absolute Maximum Ratings

Parameters	Green	Blue	Units
DC Forward Current <sup>a</sup>	30	20	mA
Peak Forward Current <sup>b</sup>	100	100	mA
Power Dissipation	114	76	mW
Reverse Voltage	Not recommended for reverse bias operation		
LED Junction Temperature	110	100	$^\circ\text{C}$
Operating Temperature Range	-40 to +85	-40 to +85	$^\circ\text{C}$
Storage Temperature Range	-40 to +100	-40 to +100	$^\circ\text{C}$

- Derate linearly as shown in [Figure 9](#).
- Duty factor = 10%, frequency = 1 kHz,  $T_A = 25^\circ\text{C}$ .

## Optical and Electrical Characteristics ( $T_J = 25^\circ\text{C}$ )

Parameters	Min.	Typ.	Max.	Units	Test Condition
Viewing Angle, $2\theta_{1/2}^a$	—	34	—	°	$I_F = 20\text{ mA}$
Dominant Wavelength, $\lambda_d^b$				nm	$I_F = 20\text{ mA}$
Green	519.0	528.0	539.0		
Blue	460.0	470.0	480.0		
Peak Wavelength, $\lambda_p$				nm	$I_F = 20\text{ mA}$
Green	—	521	—		
Blue	—	466	—		
Forward Voltage, $V_F^c$				V	$I_F = 20\text{ mA}$
Green	—	2.8	3.8		
Blue	—	2.8	3.8		
Reverse Voltage, $V_R^d$				V	$I_R = 100\ \mu\text{A}$
Green	5	—	—		
Blue	5	—	—		
Thermal Resistance, $R_{\theta J-P}^e$				°C/W	LED junction to pin
Green	—	270	—		
Blue	—	480	—		

a.  $\theta_{1/2}$  is the off-axis angle where the luminous intensity is  $1/2$  the peak intensity.

b. The dominant wavelength,  $\lambda_d$ , is derived from the CIE Chromaticity Diagram and represents the perceived color of the device.

c. The forward voltage tolerance is  $\pm 0.1\text{V}$ .

d. Indicates product final test condition. Long term reverse bias is not recommended.

e. Thermal resistance from LED junction to pin.

## Part Numbering System

A A M D - C x<sub>1</sub> 3 3 - x<sub>2</sub> x<sub>3</sub> x<sub>4</sub> x<sub>5</sub> x<sub>6</sub>

Code	Description	Option	
x <sub>1</sub>	Color	M	Green
		B	Blue
x <sub>2</sub>	Minimum intensity bin	Refer to selection guide	
x <sub>3</sub>	Maximum intensity bin	Refer to selection guide	
x <sub>4</sub>	Color bin option	0	Full distribution
		B	Color bins 2 and 3
		C	Color bins 3 and 4
x <sub>5</sub> , x <sub>6</sub>	Packaging option	02	Test current = 20 mA

## Part Number Example

AAMD – CB33 – STB02

x<sub>1</sub> : B – Blue color  
 x<sub>2</sub> : S – Minimum intensity bin S  
 x<sub>3</sub> : T – Maximum intensity bin T  
 x<sub>4</sub> : B – Color bins 2 and 3  
 x<sub>5</sub>, x<sub>6</sub> : 02 – Tested at 20 mA

## Bin Information

### Intensity Bin Limits (CAT)

Bin ID	Luminous Intensity, $I_v$ (mcd)	
	Min.	Max.
<b>Green</b>		
Z	12000	16000
1	16000	21000
<b>Blue</b>		
S	1900	2500
T	2500	3200

Tolerance =  $\pm 15\%$ .

### Color Bin Limits (BIN)

Bin ID	Dominant Wavelength, $\lambda_d$ (nm)	
	Min.	Max.
<b>Green</b>		
1	519	523
2	523	527
3	527	531
4	531	535
5	535	539
<b>Blue</b>		
1	460	464
2	464	468
3	468	472
4	472	476
5	476	480

Tolerance =  $\pm 1.0$  nm

Example of bin information on reel and packaging label:

CAT : Z – Intensity bin Z

BIN : 2 – Color bin 2

Figure 2: Spectral Power Distribution

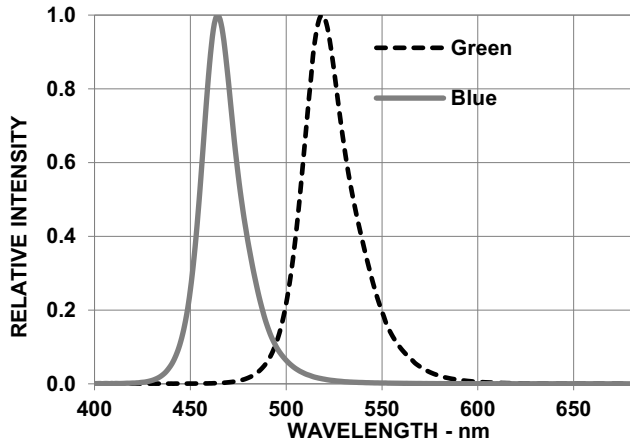

Figure 3: Forward Current vs. Forward Voltage

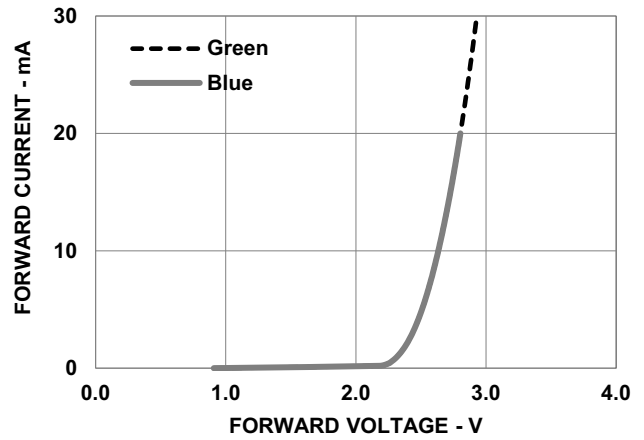

Figure 4: Relative Luminous Intensity vs. Mono Pulse Current

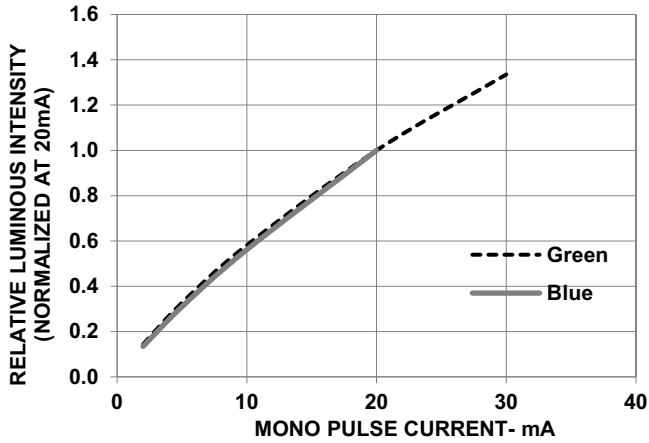

Figure 5: Dominant Wavelength Shift vs. Mono Pulse Current

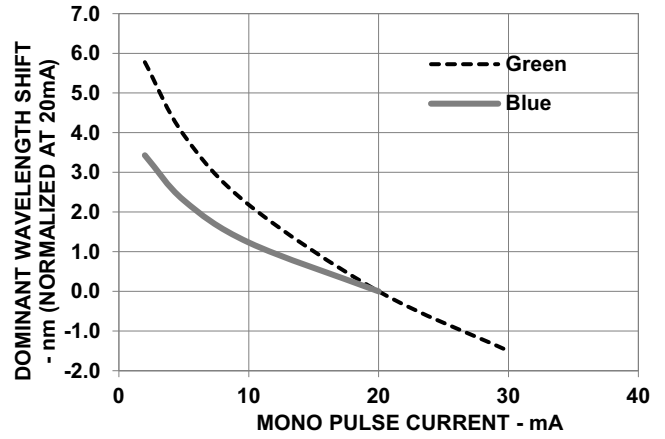

Figure 6: Relative Light Output vs. Junction Temperature

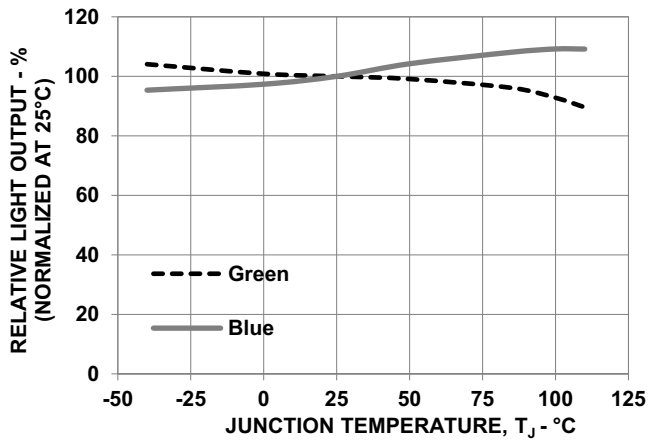

Figure 7: Forward Voltage Shift vs. Junction Temperature

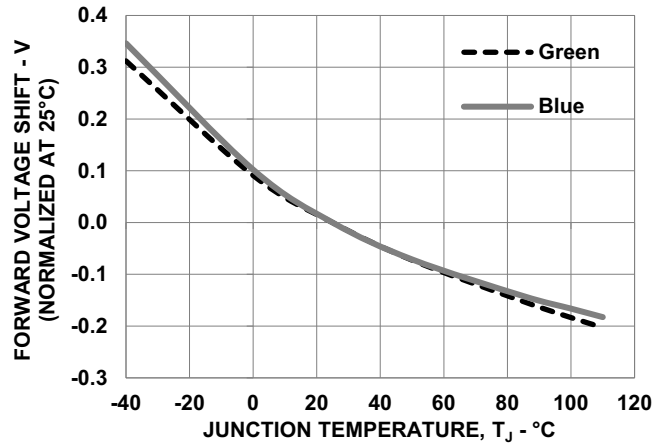

Figure 8: Radiation Pattern

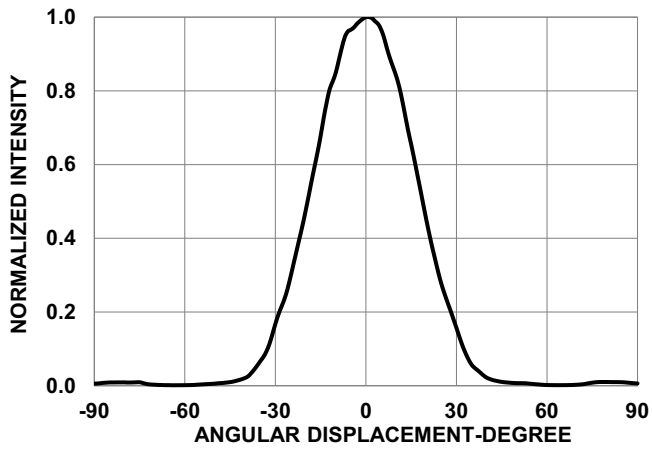

Figure 9: Maximum Forward Current vs. Ambient Temperature. Derate based on  $T_{J\ MAX} = 110^{\circ}\text{C}$  (Green),  $T_{J\ MAX} = 100^{\circ}\text{C}$  (Blue).

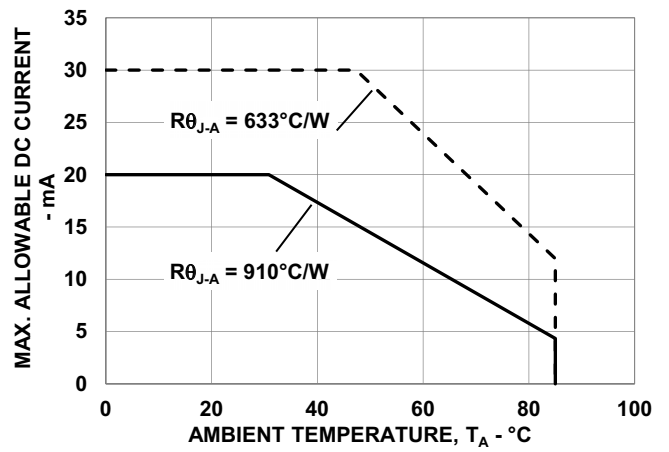
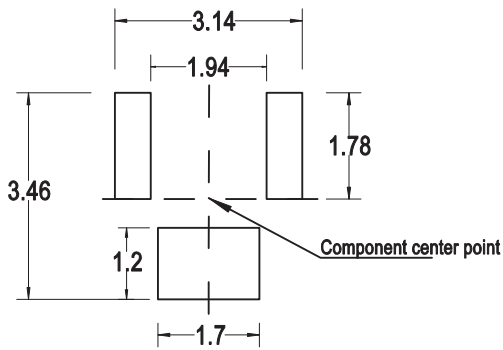

Figure 10: Recommended Soldering Land Pattern



**NOTE:**

1. All dimensions are in millimeters (mm).
2. Recommended stencil thickness is 0.15 mm (6 mil) minimum.



Figure 11: Carrier Tape Dimensions

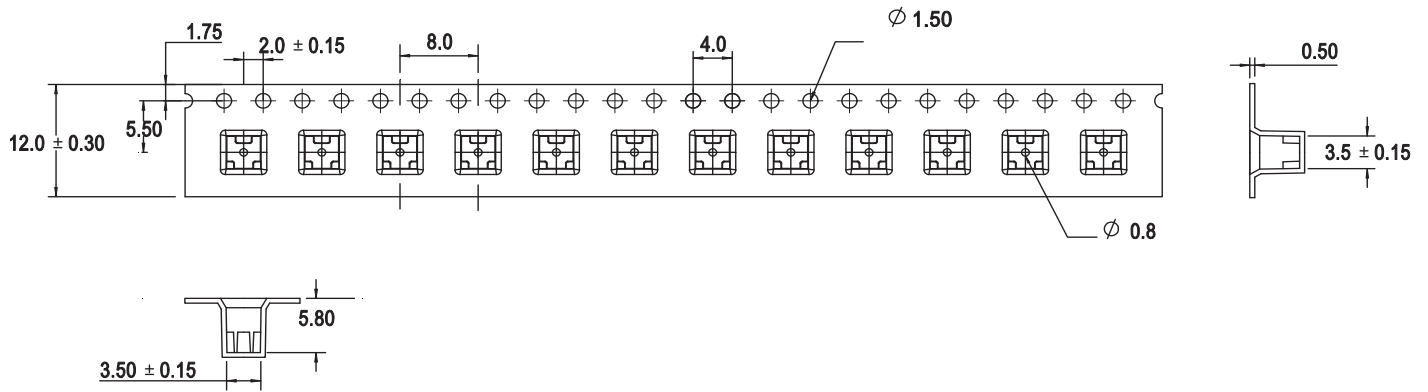

**NOTE:**

1. All dimensions are in millimeters (mm).
2. Tolerance is  $\pm 0.10$  mm unless otherwise specified.
3. LED quantity per reel is 1200 pieces.

Figure 12: Reel Dimensions

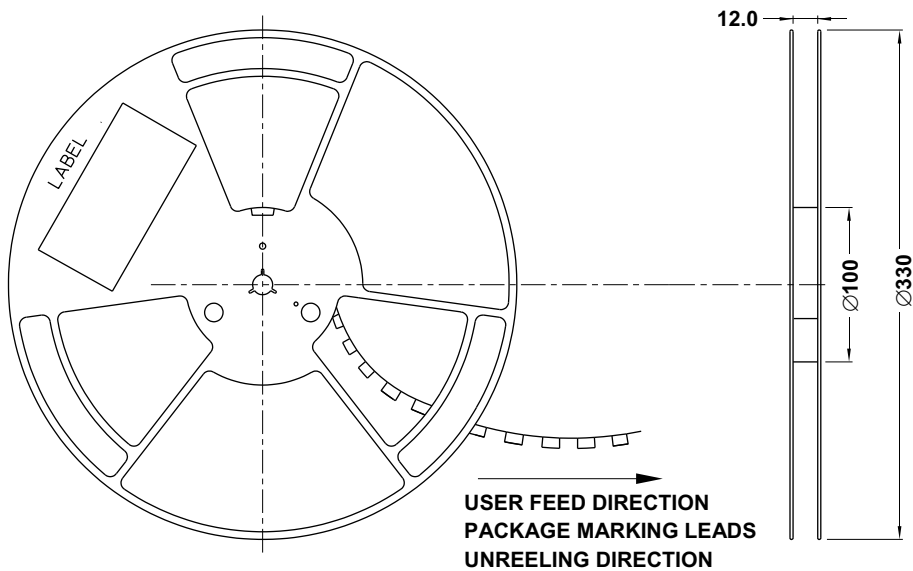

## Precautionary Notes

### Soldering

- Do not perform reflow soldering more than twice. Observe necessary precautions of handling moisture-sensitive devices as stated in the following section.
- Do not apply any pressure or force on the LED during reflow and after reflow when the LED is still hot.
- Use reflow soldering to solder the LED. Use hand soldering only for rework if unavoidable, but it must be strictly controlled to following conditions:
  - Soldering iron tip temperature = 315°C maximum
  - Soldering duration = 3 seconds maximum
  - Number of cycles = 1 only
  - Power of soldering iron = 50W maximum
- Do not touch the LED package body with the soldering iron except for the soldering terminals, as it may cause damage to the LED.
- Confirm beforehand whether the functionality and performance of the LED is affected by soldering with hand soldering.

Figure 13: Recommended Lead-Free Reflow Soldering Profile

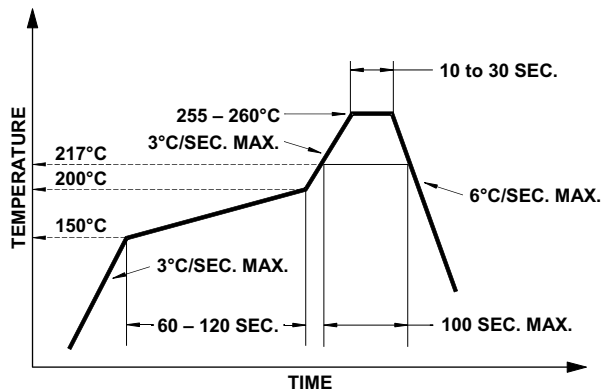

### Handling Precautions

For automated pick-and-place, Broadcom has tested the following nozzle size to work with this LED. However, due to the possibility of variations in other parameters, such as the pick-and-place machine maker/model, and other settings of the machine, verify that the selected nozzle performs as per requirements.

Figure 14: Recommended Nozzle Dimension

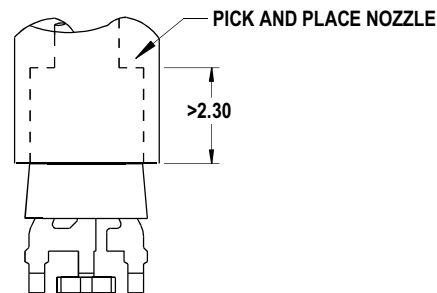

#### NOTE:

1. The nozzle tip must touch the LED flange during pick-and-place.
2. The outer dimensions of the nozzle tip must be able to fit into the carrier tape pocket until it touches the LED flange.
3. All dimensions are in millimeters (mm).

## Handling of Moisture-Sensitive Devices

This product has a Moisture Sensitive Level 3 rating per JEDEC J-STD-020. Refer to Broadcom Application Note AN5305, *Handling of Moisture Sensitive Surface Mount Devices*, for additional details and a review of proper handling procedures.

- Before use:
  - An unopened moisture barrier bag (MBB) can be stored at <40°C/90% RH for 12 months. If the actual shelf life has exceeded 12 months and the Humidity Indicator Card (HIC) indicates that baking is not required, then it is safe to reflow the LEDs per the original MSL rating.
  - Do not open the MBB prior to assembly (for example, for IQC). If unavoidable, the MBB must be properly resealed with fresh desiccant and HIC. The exposed duration must be taken in as floor life.
- Control after opening the MBB:
  - Read the HIC immediately upon opening the MBB.
  - Keep the LEDs at <30°C/60% RH at all times, and complete all high temperature-related processes, including soldering, curing, and rework within 168 hours.
- Control for unfinished reel:
 

Store unused LEDs in a sealed MBB with desiccant or a desiccator at <5% RH.
- Control of assembled boards:
 

If the PCB soldered with the LEDs is to be subjected to other high-temperature processes, store the PCB in a sealed MBB with desiccant or desiccator at <5% RH to ensure that all LEDs have not exceeded their floor life of 168 hours.
- Baking is required if the following conditions exist:
  - The HIC indicates a change in color for 10% and 5%, as stated on the HIC.
  - The LEDs are exposed to conditions of >30°C/60% RH at any time.
  - The LED's floor life exceeded 168 hours.

The recommended baking condition is: 60°C ± 5°C for 20 hours.

Baking can only be done once.
- Storage:
 

The soldering terminals of these Broadcom LEDs are silver plated. If the LEDs are exposed in an ambient environment for too long, the silver plating might become oxidized, thus affecting its solderability performance. As such, keep unused LEDs in a sealed MBB with desiccant or in a desiccator at <5% RH.

## Application Precautions

- The drive current of the LED must not exceed the maximum allowable limit across temperature as stated in the data sheet. Constant current driving is recommended to ensure consistent performance.
- Circuit design must cater to the whole range of forward voltage ( $V_F$ ) of the LEDs to ensure the intended drive current can always be achieved.
- The LED exhibits slightly different characteristics at different drive currents, which may result in a larger variation of performance (such as intensity, wavelength, and forward voltage). Set the application current as close as possible to the test current to minimize these variations.
- Avoid rapid changes in ambient temperatures, especially in high-humidity environments, because they cause condensation on the LED.
- The LED is not intended for reverse bias. Use other appropriate components for such purposes. When driving the LED in matrix form, ensure that the reverse bias voltage does not exceed the allowable limit of the LED.
- Avoid rapid change in ambient temperature, especially in high-humidity environments, because they cause condensation on the LED.
- If the LED is intended to be used in a harsh or an outdoor environment, protect the LED against damages caused by rain water, water, dust, oil, corrosive gases, external mechanical stresses, and so on.

## Thermal Management

The optical, electrical, and reliability characteristics of the LED are affected by temperature. Keep the junction temperature ( $T_J$ ) of the LED below the allowable limit at all times.  $T_J$  can be calculated as follows:

$$T_J = T_A + R_{\theta J-A} \times I_F \times V_{Fmax}$$

where:

$T_A$  = Ambient temperature ( $^{\circ}\text{C}$ )

$R_{\theta J-A}$  = Thermal resistance from LED junction to ambient ( $^{\circ}\text{C}/\text{W}$ )

$I_F$  = Forward current (A)

$V_{Fmax}$  = Maximum forward voltage (V)

The complication of using this formula lies in  $T_A$  and  $R_{\theta J-A}$ . Actual  $T_A$  is sometimes subjective and hard to determine.  $R_{\theta J-A}$  varies from system to system depending on design and is usually not known.

Another way of calculating  $T_J$  is by using the solder point temperature,  $T_S$ , as follows:

$$T_J = T_S + R_{\theta J-S} \times I_F \times V_{Fmax}$$

where:

$T_S$  = LED solder point temperature as shown in the following figure ( $^{\circ}\text{C}$ )

$R_{\theta J-S}$  = Thermal resistance from junction to solder point ( $^{\circ}\text{C}/\text{W}$ )

$I_F$  = Forward current (A)

$V_{Fmax}$  = Maximum forward voltage (V)

**Figure 15: Solder Point Temperature on PCB**

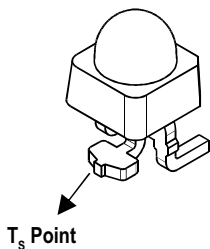

$T_S$  can be easily measured by mounting a thermocouple on the soldering joint as shown in [Figure 15](#), while  $R_{\theta J-S}$  is provided in the data sheet. Verify the  $T_S$  of the LED in the final product to ensure that the LEDs are operating within all maximum ratings stated in the data sheet.

## Eye Safety Precautions

LEDs may pose optical hazards when in operation. Do not look directly at operating LEDs because it might be harmful to the eyes. For safety reasons, use appropriate shielding or personal protective equipment.

## Disclaimer

Broadcom's products and software are not specifically designed, manufactured, or authorized for sale as parts, components, or assemblies for the planning, construction, maintenance, or direct operation of a nuclear facility or for use in medical devices or applications. The customer is solely responsible, and waives all rights to make claims against Broadcom or its suppliers, for all loss, damage, expense, or liability in connection with such use.

Copyright © 2022 Broadcom. All Rights Reserved. The term "Broadcom" refers to Broadcom Inc. and/or its subsidiaries. For more information, go to [www.broadcom.com](http://www.broadcom.com). All trademarks, trade names, service marks, and logos referenced herein belong to their respective companies.

Broadcom reserves the right to make changes without further notice to any products or data herein to improve reliability, function, or design. Information furnished by Broadcom is believed to be accurate and reliable. However, Broadcom does not assume any liability arising out of the application or use of this information, nor the application or use of any product or circuit described herein, neither does it convey any license under its patent rights nor the rights of others.

