

**maxGUARD
AMG ELM-2F EX****Weidmüller Interface GmbH & Co. KG**

Klingenbergstraße 16

D-32758 Detmold

Germany

Fon: +49 5231 14-0

Fax: +49 5231 14-292083

www.weidmueller.com



Efficient machine and facility operation calls for fail-safe and maintenance-friendly control voltage distribution that can be installed in a time and space-saving manner.

With the new maxGUARD system, the terminal blocks (previously installed separately) for distributing potential to the outputs of the electronic load monitors become an integral part of a 24 V DC control voltage distribution system.

The innovative combination of load monitoring and potential distribution saves time during installation, increases safety against failure and reduces the amount of space required on the terminal rail by 50%.

General ordering data

Type	AMG ELM-2F EX
Order No.	2082050000
Version	Electronic load monitoring, 2.00 A, 24 V DC
GTIN (EAN)	4050118419467
Qty.	1 pc(s).

**maxGUARD
AMG ELM-2F EX**

Weidmüller Interface GmbH & Co. KG
 Klingenbergstraße 16
 D-32758 Detmold
 Germany
 Fon: +49 5231 14-0
 Fax: +49 5231 14-292083
 www.weidmueller.com

Technical data**Dimensions and weights**

Width	6.1 mm	Width (inches)	0.24 inch
Height	125 mm	Height (inches)	4.921 inch
Depth	96.5 mm	Depth (inches)	3.799 inch
Net weight	40 g		

Temperatures

Operating temperature, max.	55 °C	Operating temperature, min.	-25 °C
Storage temperature, max.	85 °C	Storage temperature, min.	-40 °C
Operating temperature	-25 °C...55 °C	Storage temperature	-40 °C...85 °C

Probability of failure

MTTF	350 Years
------	-----------

Input

Current consumption (full load)	I _{OUT} +30 mA	Current consumption (idle)	25 mA
DC input voltage range	18...30 V DC	Input fuse (internal)	Yes
Rated input voltage	24 V DC	Surge protection	Suppressor diode
max. admissible residual ripple at the input	100 mVpp		

output

Capacitive load	10,000 µF	Connection system	PUSH IN
Rated current	2 A	Surge protection	Suppressor diode
Switch-on delay	1 s	Triggering characteristic	see characteristic curve
adjustable rated current	No		

General data

Conformal coating	Yes	Function key	Activation time < 3s, Reset, ON
Operating temperature	-25 °C...55 °C	Power loss, idling	415 mW
Power loss, nominal load	565 mW	Protection degree	IP20
Relay to activate the output	No	Surge voltage category	III

Insulation coordination

Surge voltage category	III
------------------------	-----

Connection data (output)

Conductor cross-section, AWG/kcmil , max.	12	Conductor cross-section, AWG/kcmil , min.	26
Conductor cross-section, flexible , max.	2.5 mm ²	Conductor cross-section, flexible , min.	0.14 mm ²
Conductor cross-section, rigid , max.	2.5 mm ²	Conductor cross-section, rigid , min.	0.14 mm ²
Connection system	PUSH IN	Number of terminals	2 (+ / -)
Screwdriver blade	0.6 x 3.5		

**maxGUARD
AMG ELM-2F EX**

Weidmüller Interface GmbH & Co. KG
Klingenbergstraße 16
D-32758 Detmold
Germany
Fon: +49 5231 14-0
Fax: +49 5231 14-292083
www.weidmueller.com

Technical data

Signalling

LED green	LED red	Load monitoring has disconnected, Load monitoring has triggered (flashing), Internal error (rapid flashing)
Operation (failure-free)		

Approvals

Institute(ATEX)	ATEX	Certificate No. (ATEX)	DEMKO17ATEX1870X
Institute (cULus)		Certificate no. (cULus)	E258476
Institute (cULusEX)		Certificate no. (cULusEX)	E470829

Ratings IECEx/ATEX/cUL

Certificate No. (ATEX)	DEMKO17ATEX1870X	Certificate No. (IECEX)	IECEXULD17.0018X
------------------------	------------------	-------------------------	------------------

Classifications

ETIM 6.0	EC002057	eClass 6.2	27-37-15-02
eClass 9.1	27-37-10-16		

Approvals

Approvals



ROHS	Conform
------	---------

Downloads

Engineering Data	EPLAN
User Documentation	Manual_maxGUARD Operating instructions

Data sheet

**maxGUARD
AMG ELM-2F EX**

Weidmüller Interface GmbH & Co. KG
 Klingenbergstraße 16
 D-32758 Detmold
 Germany
 Fon: +49 5231 14-0
 Fax: +49 5231 14-292083
 www.weidmueller.com

Drawings

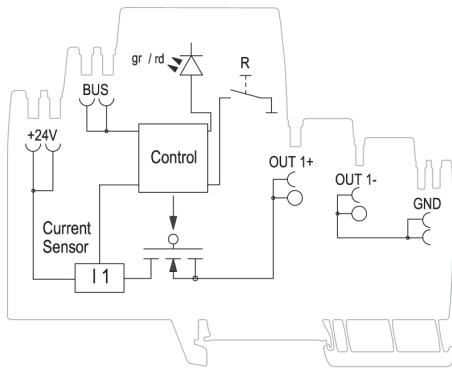

Schematic circuit diagram

Tripping characteristic normal

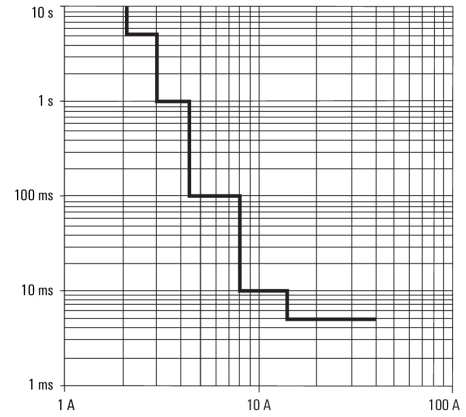

Tripping characteristic