

M12 FEMALE 90° FIELD-WIREABLE SCREW TERM.4-pol. max.0,75mm² 6-8mm

Female 90°

4-pole

Clamping range cable entry: 6...8 mm

Plastic housings with good resistance against chemicals and oils. The resistance to aggressive media should be individually tested for your application. Further details on request.

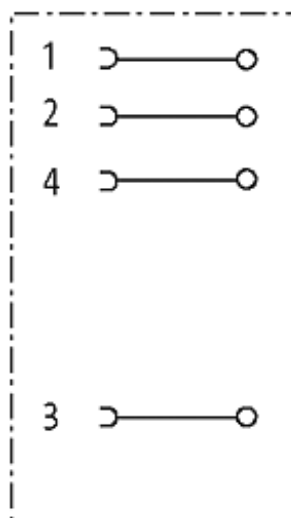
[Link to Product](#)**Illustration**

Female

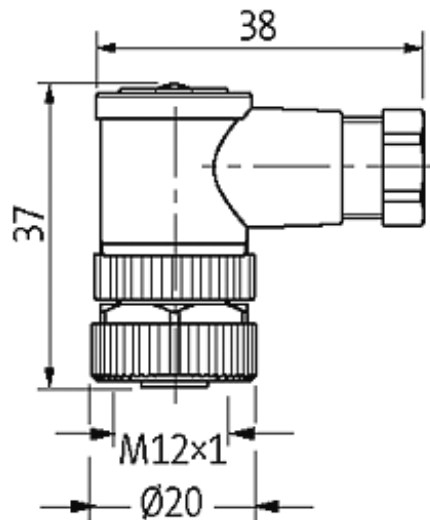

Product may differ from Image

Approvals



Form

13021

Technical Data

Operating voltage	max. 250 V AC/DC
Operating current per contact	max. 4 A
Connection cross section	max. 0.75 mm ²
Sealing range (cable diameter)	6...8 mm
Locking of ports	Screw thread M12 × 1 mm (recommended torque 0.6 Nm) self-securing
Protection	IP67 inserted and tightened (EN 60529)

General data

Temperature range	-25...+85 °C
-------------------	--------------

Commercial data

country of origin	DE
customs tariff number	85369010
minimum order quantity	1