

DESCRIPTION

The MPM3811 is a monolithic, step-down, switch-mode converter with built-in, internal power MOSFETs and an inductor. The MPM3811 achieves 1A of continuous output current from a 2.3V to 5.5V input voltage with excellent load and line regulation. The MPM3811 is ideal for a wide range of applications, including high performance DSPs, wireless power, portable and mobile devices, and other low-power systems. The output voltage can be regulated as low as 0.6V. Only input capacitors, output capacitors, and feedback (FB) resistors are needed to complete the design.

The constant-on-time (COT) control scheme provides fast transient response, high light-load efficiency, and easy loop stabilization.

Full protection features include cycle-by-cycle current limiting and thermal shutdown.

The MPM3811 requires a minimal number of readily available, standard, external components and is available in an ultra-small QFN-10 (2mmx2mmx1.6mm) package.

FEATURES

- Up to 91% Peak Efficiency
- Wide 2.3V to 5.5V Operating Input Range
- Output Voltage as Low as 0.6V
- 100% Duty Cycle in Dropout
- 1A Output Current
- 2.2MHz Frequency
- EN for Power Sequencing
- Cycle-by-Cycle Over-Current Protection (OCP)
- 0.5ms Internal Soft-Start (SS) Time
- Output Discharge
- Short-Circuit Protection (SCP) with Hiccup Mode
- Thermal Shutdown
- Stable with Low ESR Output Ceramic Capacitors
- Available in a QFN10 (2mmx2mmx1.6mm) Package

APPLICATIONS

- Optical Modules
- IoT Devices
- Handheld Printers/POS
- Portable Devices
- Low Voltage I/O System Power
- Space-Constraint Systems

All MPS parts are lead-free, halogen-free, and adhere to the RoHS directive. For MPS green status, please visit the MPS website under Quality Assurance. "MPS", the MPS logo, and "Simple, Easy Solutions" are trademarks of Monolithic Power Systems, Inc. or its subsidiaries.

TYPICAL APPLICATION

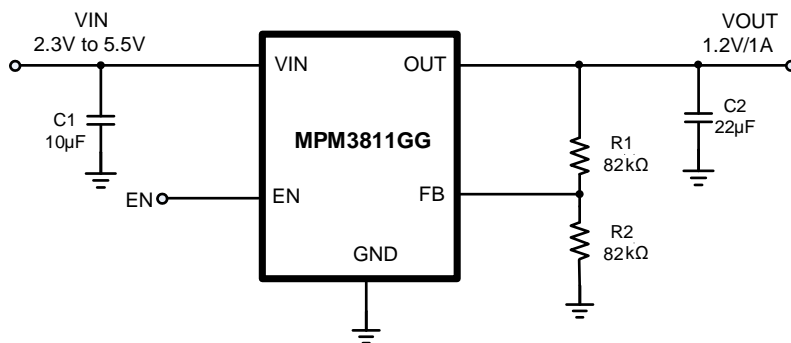

Efficiency vs. Output Current

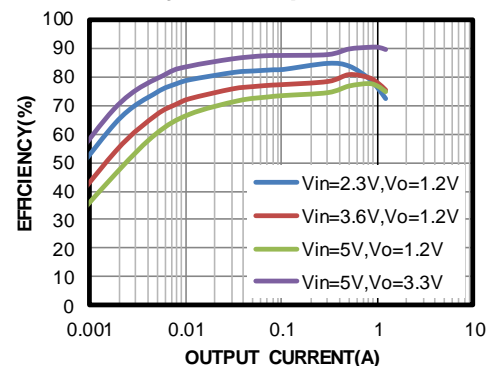

ORDERING INFORMATION

Part Number	Package	Top Marking
MPM3811GG	QFN-10 (2mmx2mmx1.6mm)	See Below

* For Tape & Reel, add suffix -Z (e.g.: MPM3811GG-Z).

TOP MARKING

—
FPY
LLL

FP: Product code of MPM3811GG
 Y: Year code
 LLL: Lot number

PACKAGE REFERENCE

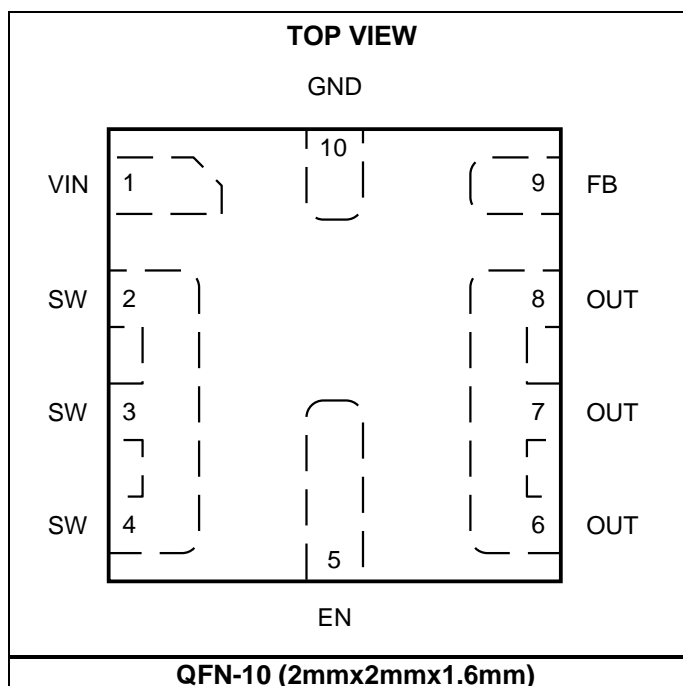

PIN FUNCTIONS

Pin #	Name	Description
1	VIN	Supply voltage. The MPM3811 operates from a +2.3V to +5.5V unregulated input range. A decoupling capacitor is needed to prevent large voltage spikes from appearing at the input.
2 - 4	SW	Output switching node. SW is the drain of the internal, high-side, P-channel MOSFET. SW is not for testing and is for internal use only.
5	EN	On/off control.
6 - 8	OUT	Output voltage power rail and input sense pin for output voltage. Connect the load to OUT. An output capacitor is needed at OUT to decrease the output voltage ripple.
9	FB	Feedback. An external resistor divider from the output to GND tapped to FB sets the output voltage.
10	GND	Power ground.

ABSOLUTE MAXIMUM RATINGS ⁽¹⁾

Supply voltage (V_{IN})	6V
V_{SW}	-0.3V (-5V for <10ns) to 6V (8V for <10ns or 10V for <3ns)
All other pins	-0.3V to 6V
Junction temperature	150°C
Lead temperature	260°C
Continuous power dissipation ($T_A = +25^\circ\text{C}$) ⁽²⁾⁽⁴⁾	1.6W
Storage temperature	-65°C to +150°C

Recommended Operating Conditions ⁽³⁾

Supply voltage (V_{IN})	2.3V to 5.5V
Operating junction temp. (T_J)...	-40°C to +125°C

Thermal Resistance	θ_{JA}	θ_{JC}
QFN-10 (2mmx2mmx1.6mm)		
EVM3811-G-00A ⁽⁴⁾	70	34... °C/W
JESD51-7 ⁽⁵⁾	80	35... °C/W

NOTES:

- Exceeding these ratings may damage the device.
- The maximum allowable power dissipation is a function of the maximum junction temperature T_J (MAX), the junction-to-ambient thermal resistance θ_{JA} , and the ambient temperature T_A . The maximum allowable continuous power dissipation at any ambient temperature is calculated by P_D (MAX) = $(T_J$ (MAX) - T_A) / θ_{JA} . Exceeding the maximum allowable power dissipation produces an excessive die temperature, causing the regulator to go into thermal shutdown. Internal thermal shutdown circuitry protects the device from permanent damage.
- The device is not guaranteed to function outside of its operating conditions.
- Measured on EVM3811-G-00A, 2-layer PCB
- The value of θ_{JA} given in this table is only valid for comparison with other packages and cannot be used for design purposes. These values were calculated in accordance with JESD51-7, and simulated on a specified JEDEC board. They do not represent the performance obtained in an actual application.

ELECTRICAL CHARACTERISTICS

$V_{IN} = 3.6V$, $T_J = -40^{\circ}C$ to $+125^{\circ}C$ ⁽⁶⁾, typical value is tested at $T_J = +25^{\circ}C$. The limit over temperature is guaranteed by characterization, unless otherwise noted.

Parameter	Symbol	Condition	Min	Typ	Max	Units
Feedback voltage	V_{FB}	$2.3V \leq V_{IN} \leq 5.5V$, $T_J = 25^{\circ}C$	0.594	0.600	0.606	V
		$T_J = -40^{\circ}C$ to $+125^{\circ}C$	0.588	0.600	0.612	
Feedback current	I_{FB}	$V_{FB} = 0.63V$		50	100	nA
P-FET switch on resistance	R_{DSON_P}			130		m Ω
N-FET switch on resistance	R_{DSON_N}			100		m Ω
Dropout resistance	R_{DR}	100% on duty		250		m Ω
Switch leakage		$V_{EN} = 0V$, $T_J = 25^{\circ}C$		0	1	μA
P-FET peak current limit			1.4	1.7		A
Switching frequency	f_s	$V_{IN} = 5V$, $V_{OUT} = 1.2V$, $I_{OUT} = 500mA$, $T_J = 25^{\circ}C$ ⁽⁶⁾	1920	2400	2910	kHz
		$V_{IN} = 5V$, $V_{OUT} = 1.2V$, $I_{OUT} = 500mA$, $T_J = -40^{\circ}C$ to $+125^{\circ}C$ ⁽⁶⁾	1800	2400	3000	kHz
Minimum off time	$T_{MIN-OFF}$			60		ns
Minimum on time ⁽⁷⁾	T_{MIN-ON}			60		ns
Soft-start time	T_{SS-ON}	V_{OUT} rise from 10% to 90%		0.5		ms
Under-voltage lockout threshold rising				2	2.25	V
Under-voltage lockout threshold hysteresis				150		mV
EN input logic low voltage					0.4	V
EN input logic high voltage			1.2			V
EN input current		$V_{EN} = 2V$		1.2		μA
		$V_{EN} = 0V$		0		μA
Supply current (shutdown)		$V_{EN} = 0V$, $T_J = 25^{\circ}C$		0	1	μA
Supply current (quiescent)		$V_{IN} = 3.6V$, $V_{EN} = 2V$, $V_{FB} = 0.63V$, $T_J = 25^{\circ}C$		340	400	μA
Thermal shutdown ⁽⁷⁾				160		$^{\circ}C$
Thermal hysteresis ⁽⁷⁾				30		$^{\circ}C$
Output discharge resistor	R_{DIS}	$V_{EN} = 0V$, $V_{OUT} = 1.2V$		1		k Ω
Output inductor	L	Test frequency 1MHz		0.47		μH
	DCR			0.1		Ω

NOTES:

- 6) Not tested in production. Guaranteed by over-temperature correlation.
 7) Guaranteed by engineering sample characterization.

TYPICAL PERFORMANCE CHARACTERISTICS

$V_{IN} = 5V$, $V_{OUT} = 1.2V$, $C_o = 22\mu F$, $T_A = +25^\circ C$, unless otherwise noted.

Efficiency vs. Output Current

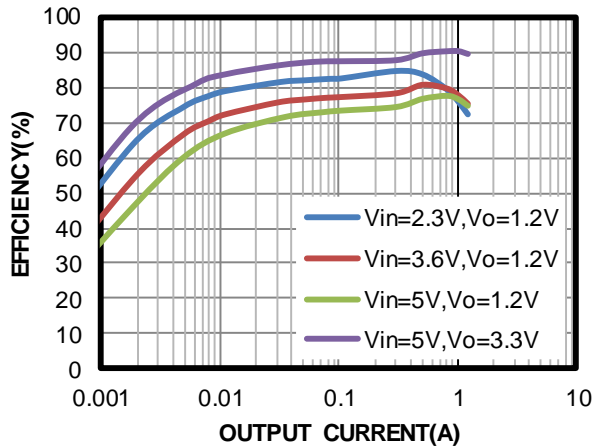

Load Regulation vs. Output Current

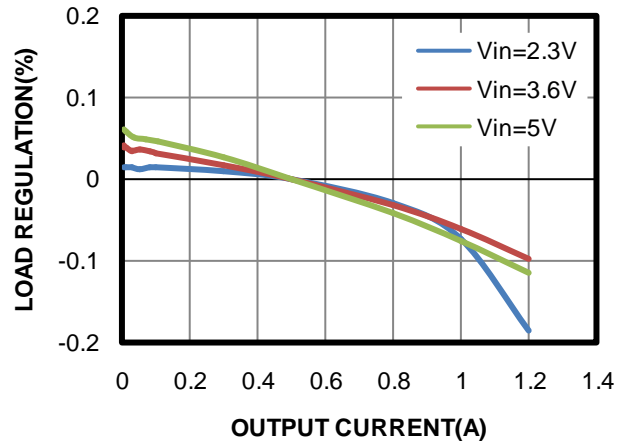

Line Regulation vs. Input Voltage

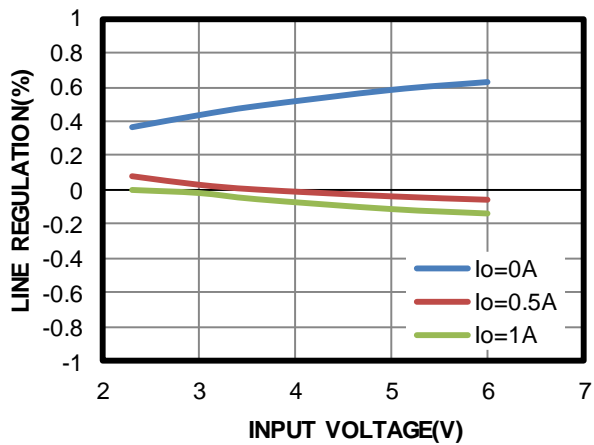

Shutdown Current vs. Input Voltage

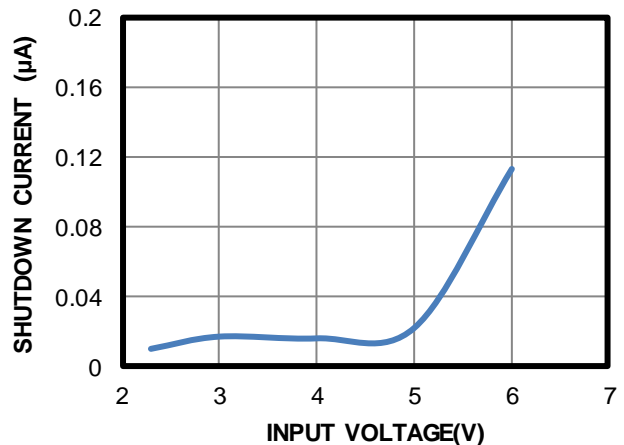

Quiescent Current vs. Input Voltage

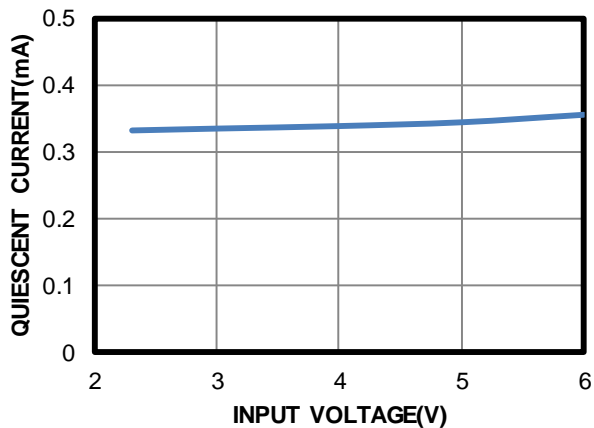

Case Temperature Rise vs. Output Current

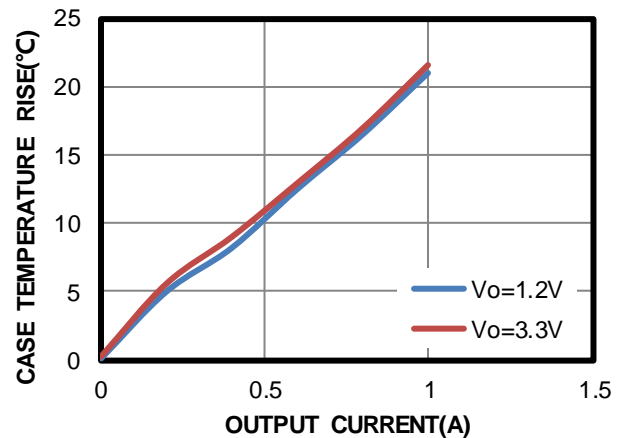

TYPICAL PERFORMANCE CHARACTERISTICS *(continued)*

$V_{IN} = 5V$, $V_{OUT} = 1.2V$, $C_o = 22\mu F$, $T_A = +25^\circ C$, unless otherwise noted.

Current Limit vs. Input Voltage

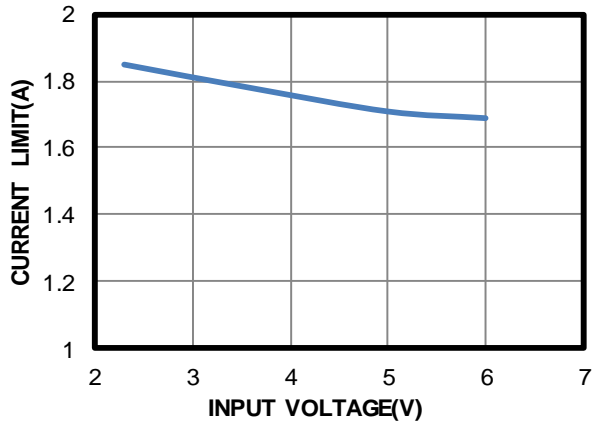

Power Loss vs. Output Current

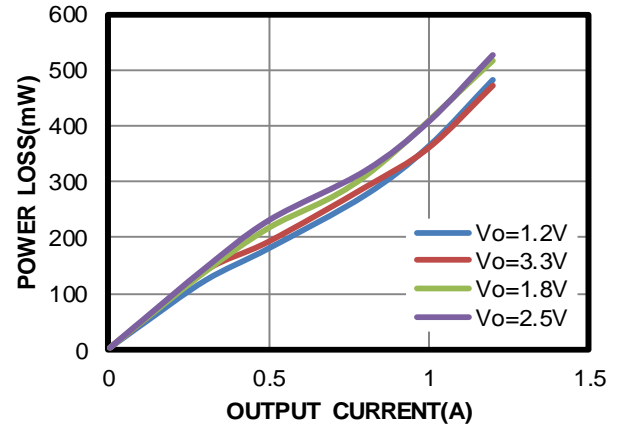

EN Rising Threshold vs. Temperature

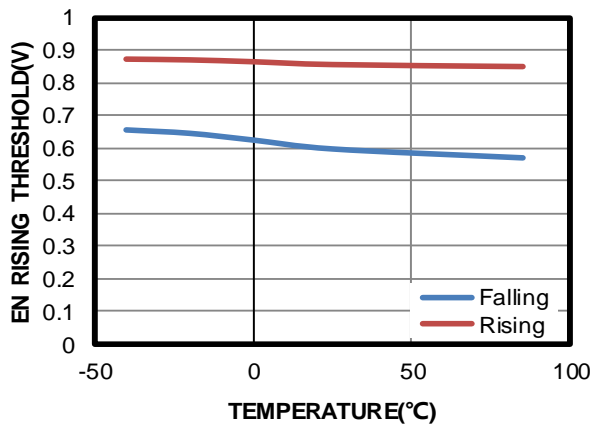

Reference Voltage vs. Temperature

$V_{IN} = 3.6V$

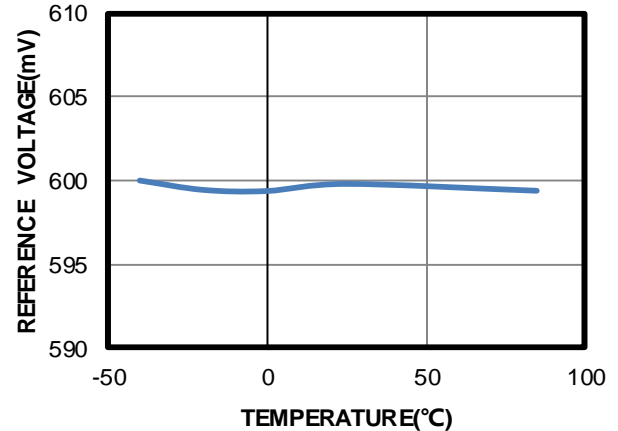

Current Limit vs. Temperature

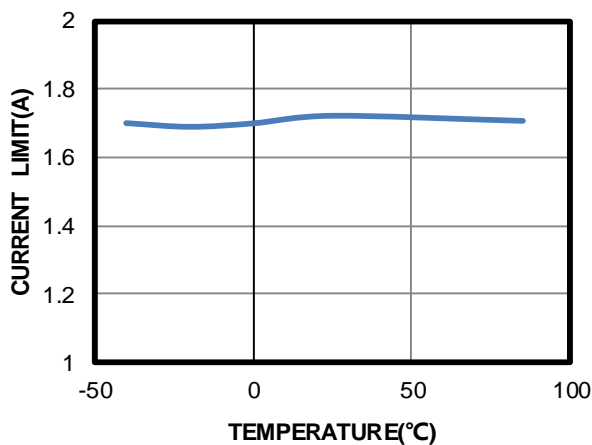

Frequency vs. Temperature

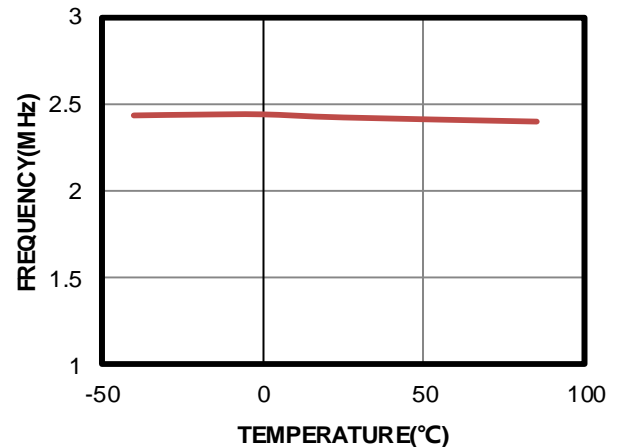

TYPICAL PERFORMANCE CHARACTERISTICS *(continued)*

$V_{IN} = 5V$, $V_{OUT} = 1.2V$, $C_o = 22\mu F$, $T_A = +25^\circ C$, unless otherwise noted.

Quiescent Current vs. Temperature

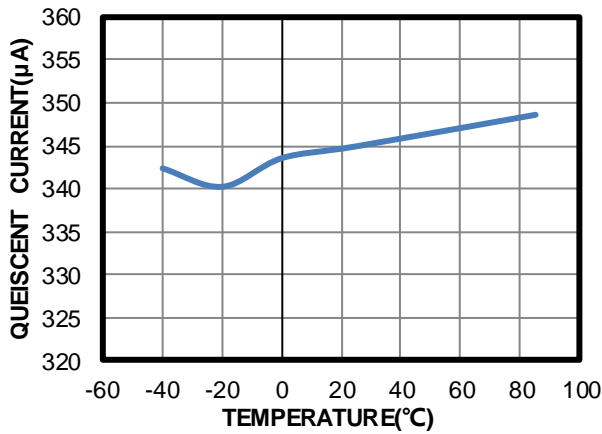

V_{IN} UVLO Threshold vs. Temperature

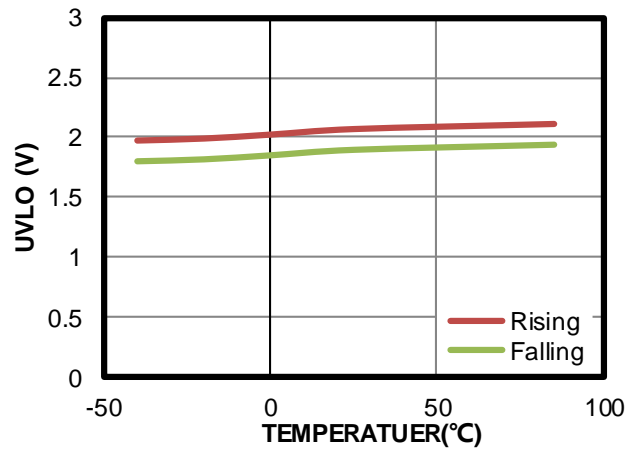

Radiated EMI

$V_{IN} = 5V$, $V_{OUT} = 1.2V$, $I_{OUT} = 1A$

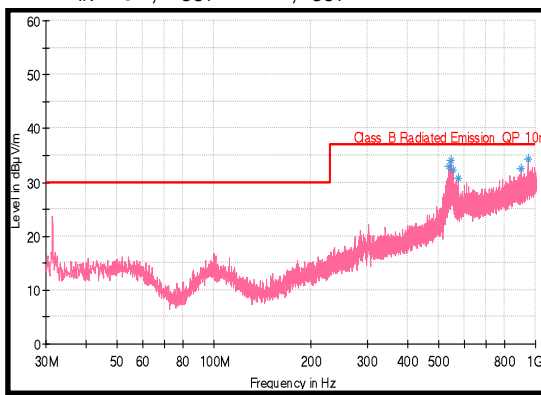

Conducted EMI

$V_{IN} = 5V$, $V_{OUT} = 1.2V$, $I_{OUT} = 1A$

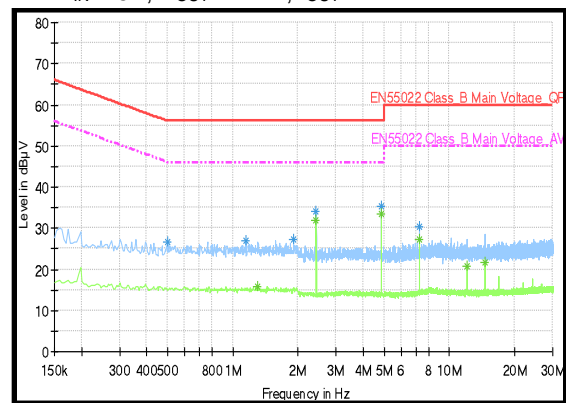

Thermal Derating

Air Flow = 0.5m/s

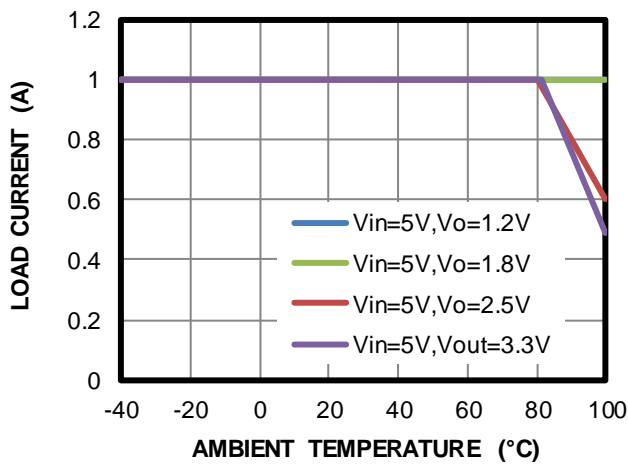

TYPICAL PERFORMANCE CHARACTERISTICS (continued)
 $V_{IN} = 5V$, $V_{OUT} = 1.2V$, $C_o = 22\mu F$, $T_A = +25^\circ C$, unless otherwise noted.

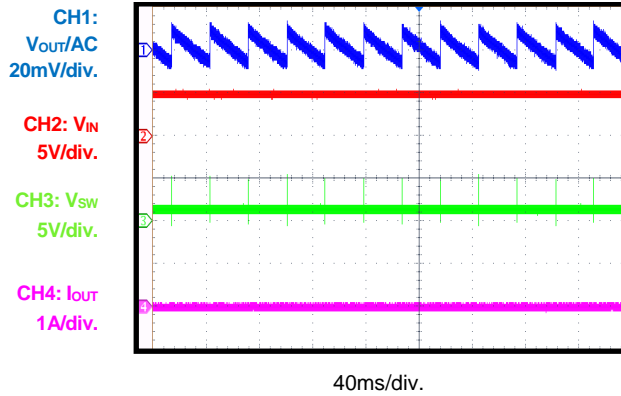
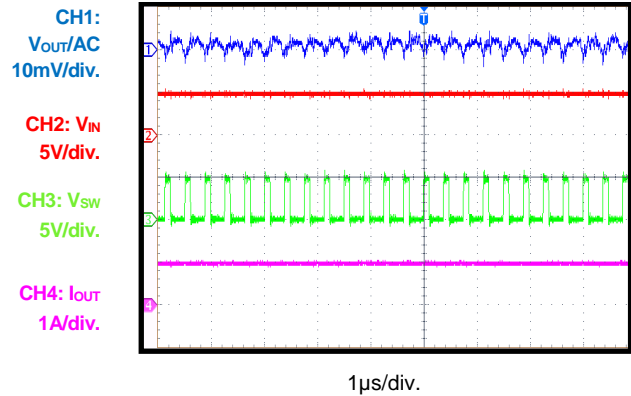
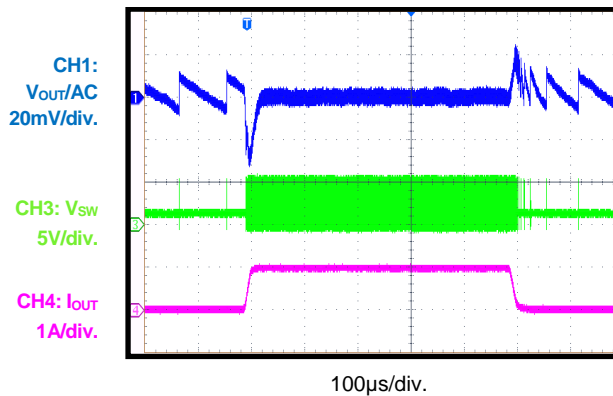
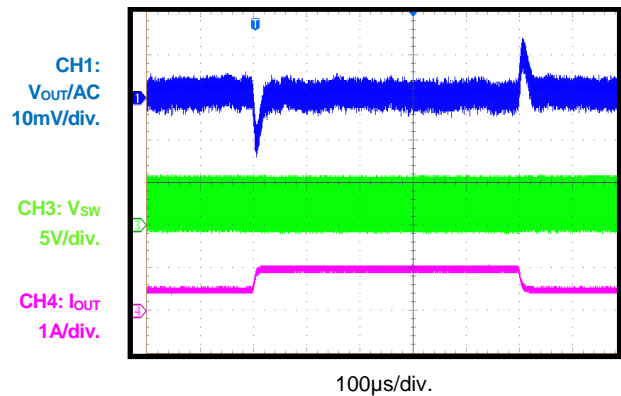
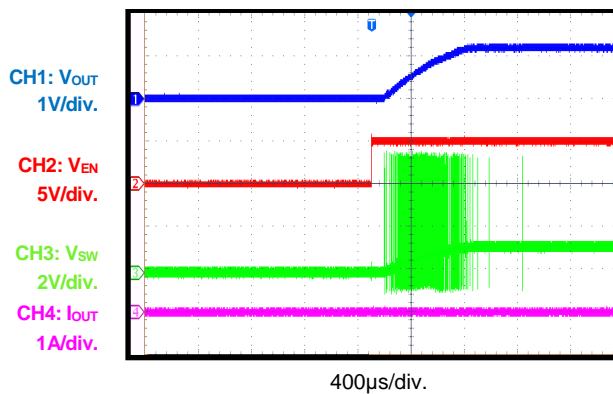
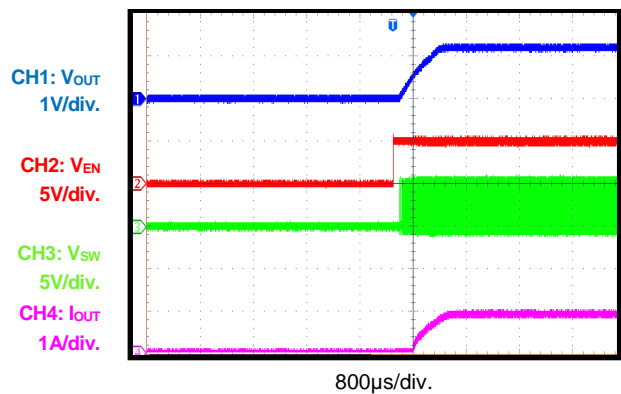
Steady State
 $I_{OUT} = 0A$

Steady State
 $I_{OUT} = 1A$

Transient
 $I_{OUT} = 0 - 1A$

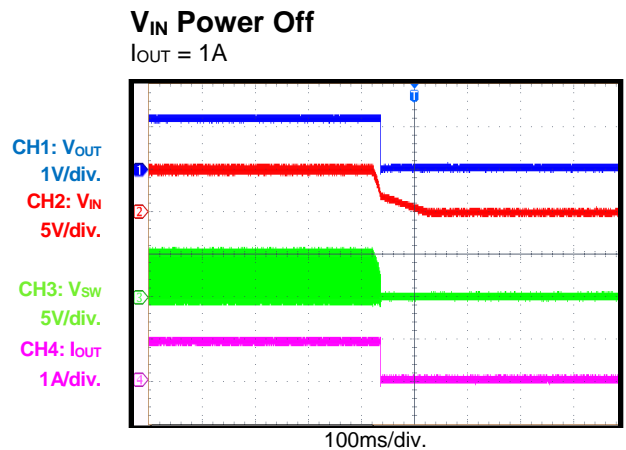
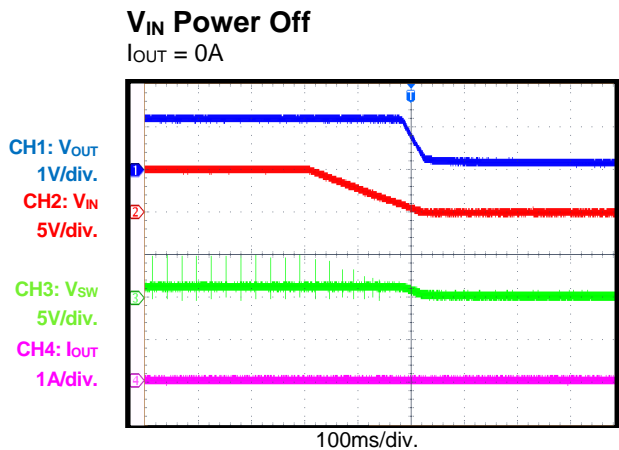
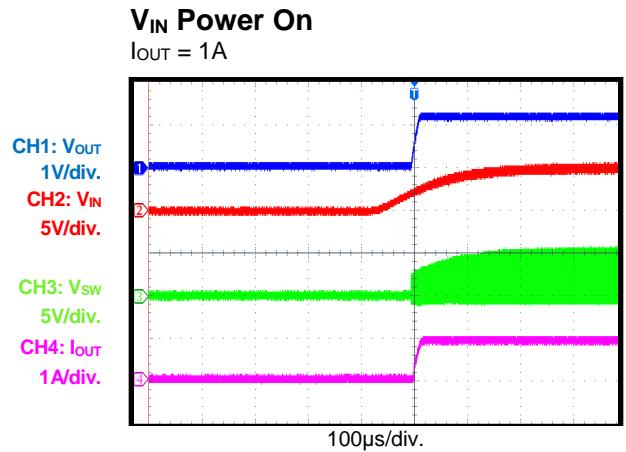
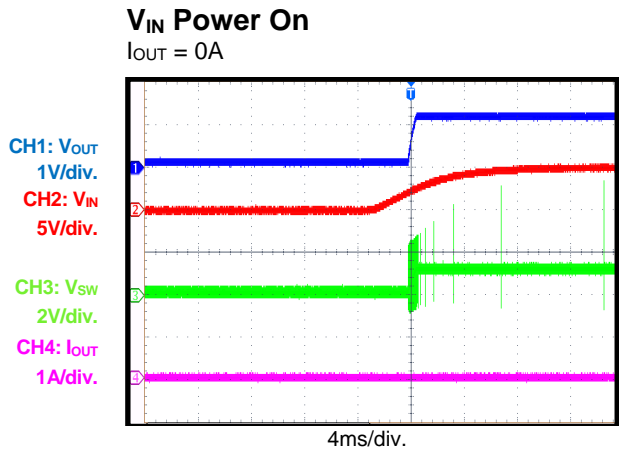
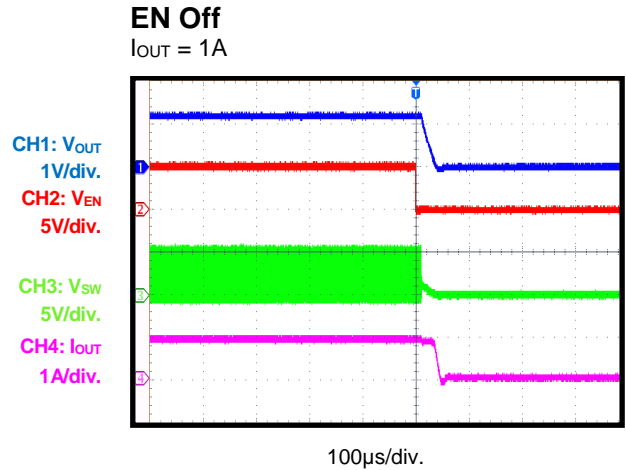
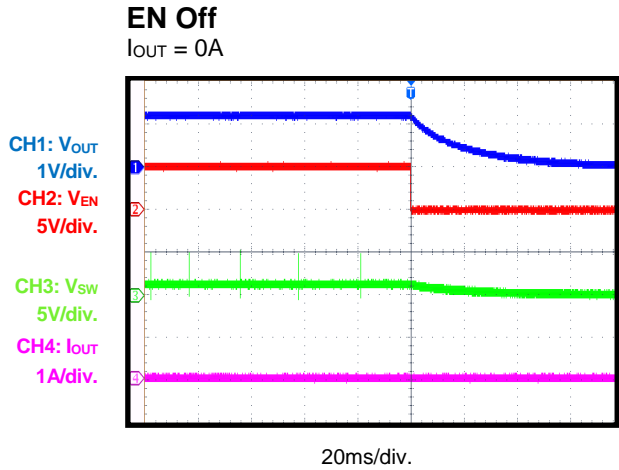
Transient
 $I_{OUT} = 0.5 - 1A$

EN On
 $I_{OUT} = 0A$

EN On
 $I_{OUT} = 1A$

TYPICAL PERFORMANCE CHARACTERISTICS *(continued)*

$V_{IN} = 5V$, $V_{OUT} = 1.2V$, $C_o = 22\mu F$, $T_A = +25^\circ C$, unless otherwise noted.



TYPICAL PERFORMANCE CHARACTERISTICS *(continued)*

$V_{IN} = 5V$, $V_{OUT} = 1.2V$, $C_o = 22\mu F$, $T_A = +25^\circ C$, unless otherwise noted.

Short-Circuit Entry

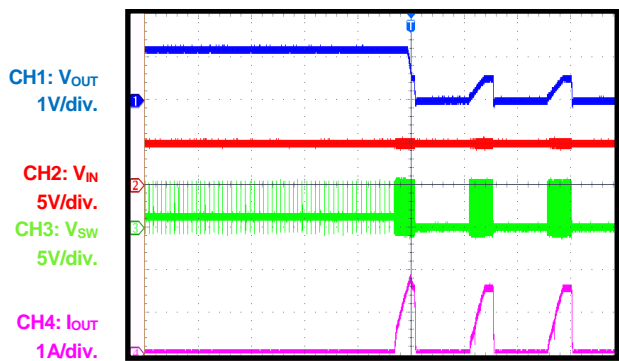

800 μs /div.

Short-Circuit Steady

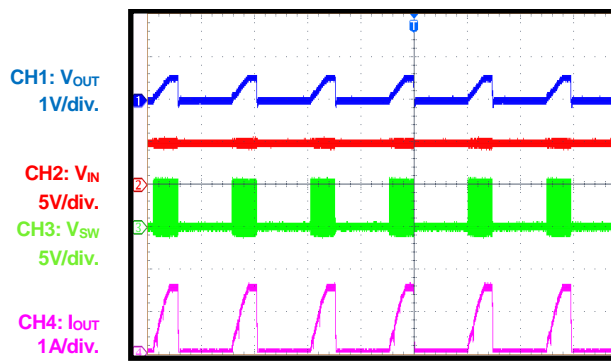

800 μs /div.

Short-Circuit Recovery

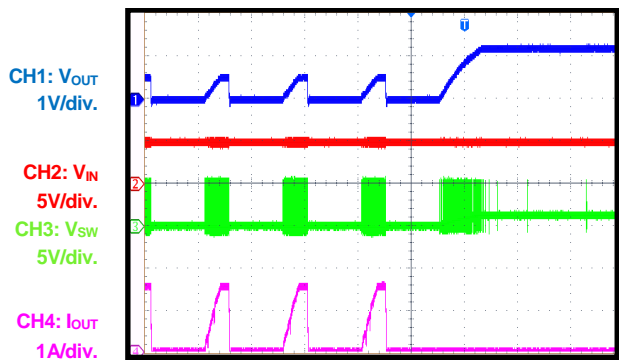

800 μs /div.

BLOCK DIAGRAM

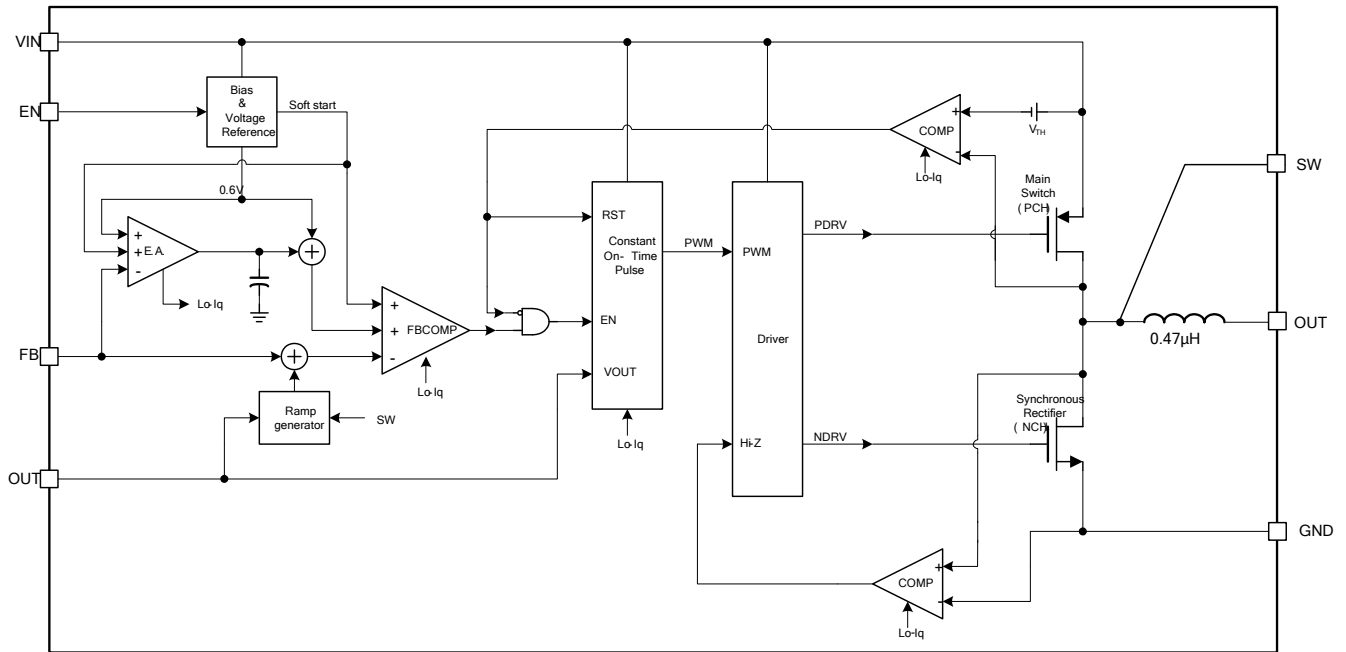

Figure 1: Functional Block Diagram

OPERATION

The MPM3811 uses constant-on-time (COT) control with input voltage feed-forward to stabilize the switching frequency over the entire input range. The MPM3811 achieves 1A of continuous output current from a 2.3V to 5.5V input voltage with excellent load and line regulation. The output voltage can be regulated as low as 0.6V.

Constant-On-Time (COT) Control

Compare to fixed frequency pulse-width modulation (PWM) control, COT control offers a simpler control loop and faster transient response. By using an input voltage feed-forward, the MPM3811 maintains a nearly constant switching frequency across the input and output voltage ranges. The switching pulse on time can be calculated with Equation (1):

$$T_{ON} = \frac{V_{OUT}}{V_{IN}} \cdot 0.455\mu s \quad (1)$$

To prevent inductor current runaway during the load transient, the MPM3811 has a fixed minimum off time of 60ns. This minimum off time limit will not affect operation in steady state in any way.

AAM Operation at Light Load

The MPM3811 uses advanced asynchronous modulation (AAM) power-save mode together with a zero-current cross detection (ZCD) circuit for light-load operation (see Figure 2). The AAM current (I_{AAM}) is set internally. At light-load operation, the SW on-pulse time is decided by the on-time generator and AAM comparator.

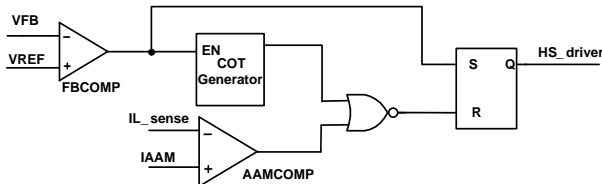

Figure 2: Simplified AAM Control Logic

The MPM3811 uses the ZCD to determine when the inductor current begins reversing. When the inductor current reaches the ZCD threshold, the low-side switch is turned off. AAM and the ZCD circuit together makes the MPM3811 work in discontinuous conduction mode (DCM) continuously at light load, even if V_{OUT} is close to V_{IN} .

Enable (EN)

When the input voltage is greater than the under-voltage lockout (UVLO) threshold (typically 2V), the MPM3811 can be enabled by pulling EN higher than 1.2V. Leave EN floating or pull EN down to ground to disable the MPM3811. There is an internal 1.7MΩ resistor from EN to ground.

When the device is disabled, the part goes into output discharge mode automatically. The internal discharge MOSFET provides a resistive discharge path for the output capacitor.

Soft Start (SS)

The MPM3811 has a built-in soft start (SS) that ramps up the output voltage at a controlled slew rate to avoid overshooting at start-up. The soft-start time is about 0.5ms, typically.

Current Limit

The MPM3811 has a 1.7A high-side switch current limit, typically. When the high-side switch reaches its current limit, the MPM3811 remains in hiccup mode until the current drops. This prevents the inductor current from continuing to rise and damaging components.

Short Circuit and Recovery

The MPM3811 enters short-circuit protection (SCP) mode when it reaches the current limit and attempts to recover with hiccup mode. The MPM3811 disables the output power stage, discharges the soft-start capacitor, and attempts to soft start again automatically. If the short-circuit condition remains after the soft start ends, the MPM3811 repeats this cycle until the short circuit is removed and the output rises back to the regulation level.

APPLICATION INFORMATION

Setting the Output Voltage

The external resistor divider sets the output voltage (see the Typical Application on page 15). Select the feedback resistor (R1) to reduce the V_{OUT} leakage current to 40 - 200k Ω , typically. There is no strict requirement on the feedback resistor. $R1 > 10k\Omega$ is reasonable for most applications. R2 can be calculated with Equation (2):

$$R2 = \frac{R1}{\frac{V_{out}}{0.6} - 1} \quad (2)$$

Figure 3 shows the feedback circuit.

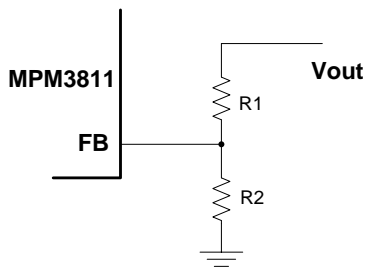

Figure 3: Feedback Network

Table 1 lists the recommended resistor values for common output voltages.

Table 1: Resistor Values for Common Output Voltages

V_{OUT} (V)	R1 (k Ω)	R2 (k Ω)
1.0	56.2 (1%)	84.5 (1%)
1.2	82 (1%)	82 (1%)
1.8	82 (1%)	41.2 (1%)
2.5	82 (1%)	26.1 (1%)
3.3	82 (1%)	18 (1%)

Selecting the Input Capacitor

The input current to the step-down converter is discontinuous and therefore requires a capacitor to supply AC current to the step-down converter while maintaining the DC input voltage. Use low ESR capacitors for the best performance. Ceramic capacitors with X5R or X7R dielectrics are highly recommended because of their low ESR and small temperature coefficients. Generally, a 10 μ F input capacitor is sufficient for most applications.

The input capacitor requires an adequate ripple current rating since it absorbs the input switching current. Estimate the RMS current in the input capacitor with Equation (3):

$$I_{C1} = I_{LOAD} \times \sqrt{\frac{V_{OUT}}{V_{IN}} \times \left(1 - \frac{V_{OUT}}{V_{IN}}\right)} \quad (3)$$

The worst-case occurs at $V_{IN} = 2V_{OUT}$, shown in Equation (4):

$$I_{C1} = \frac{I_{LOAD}}{2} \quad (4)$$

For simplification, choose an input capacitor with an RMS current rating greater than half of the maximum load current.

The input capacitor can be electrolytic, tantalum, or ceramic. When using electrolytic or tantalum capacitors, add a small, high-quality, 0.1 μ F, ceramic capacitor as close to the IC as possible. When using ceramic capacitors, ensure that they have enough capacitance to provide a sufficient charge to prevent excessive voltage ripple at the input. The input voltage ripple caused by the capacitance can be estimated with Equation (5):

$$\Delta V_{IN} = \frac{I_{LOAD}}{f_s \times C1} \times \frac{V_{OUT}}{V_{IN}} \times \left(1 - \frac{V_{OUT}}{V_{IN}}\right) \quad (5)$$

Selecting the Output Capacitor

The output capacitor (C2) stabilizes the DC output voltage. Low ESR ceramic capacitors are recommended to limit the output voltage ripple. Estimate the output voltage ripple with Equation (6):

$$\Delta V_{OUT} = \frac{V_{OUT}}{f_s \times L_1} \times \left(1 - \frac{V_{OUT}}{V_{IN}}\right) \times \left(R_{ESR} + \frac{1}{8 \times f_s \times C2}\right) \quad (6)$$

Where L_1 is the inductor value, and R_{ESR} is the equivalent series resistance (ESR) value of the output capacitor. The MPM3811 has an internal, co-packaged, 0.47 μ H power inductor.

When using ceramic capacitors, the capacitance dominates the impedance at the switching frequency and causes most of the output voltage ripple.

For simplification, the output voltage ripple can be estimated with Equation (7):

$$\Delta V_{OUT} = \frac{V_{OUT}}{8 \times f_s^2 \times L_1 \times C_2} \times \left(1 - \frac{V_{OUT}}{V_{IN}} \right) \quad (7)$$

For tantalum or electrolytic capacitors, the ESR dominates the impedance at the switching frequency. For simplification, the output ripple can be approximated with Equation (8):

$$\Delta V_{OUT} = \frac{V_{OUT}}{f_s \times L_1} \times \left(1 - \frac{V_{OUT}}{V_{IN}} \right) \times R_{ESR} \quad (8)$$

The characteristics of the output capacitor also affect the stability of the regulation system. Typically, a 10 μ F output capacitor is enough to meet most applications. Add a 22 μ F output capacitor to achieve a low output voltage ripple.

PCB Layout Guidelines

Efficient PCB layout of the switching power supplies is critical for stable operation. For the high-frequency switching converter, a poor layout design can result in poor line or load regulation and stability issues. For best results, refer to Figure 4 and Figure 5 and follow the guidelines below.

1. Place the high-current paths (GND and IN) very close to the device with short, direct, and wide traces.
2. Place the input capacitor as close to IN and GND as possible.
3. Place the external feedback resistors next to FB.

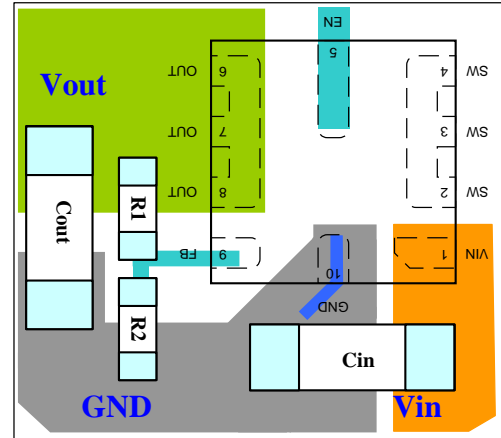

Figure 4: Single-Layer PCB Layout

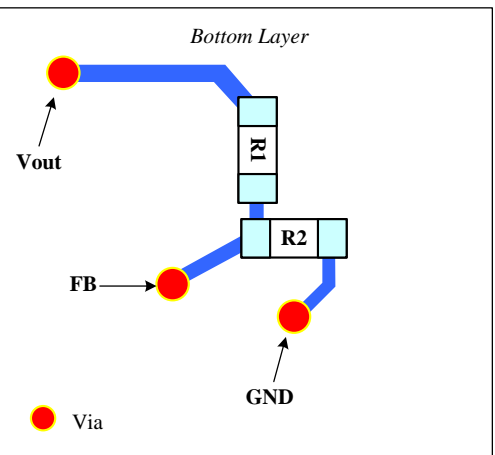
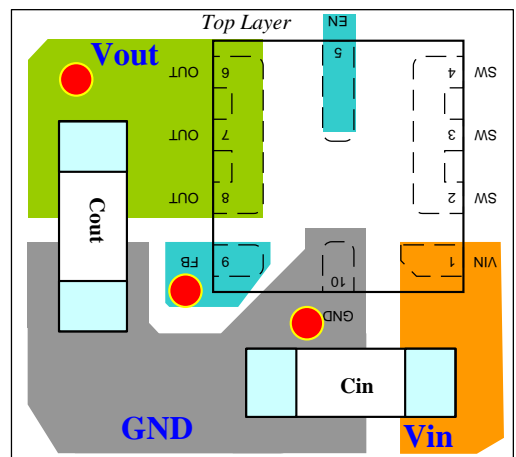

Figure 5: Double-Layer PCB Layout

TYPICAL APPLICATION CIRCUITS

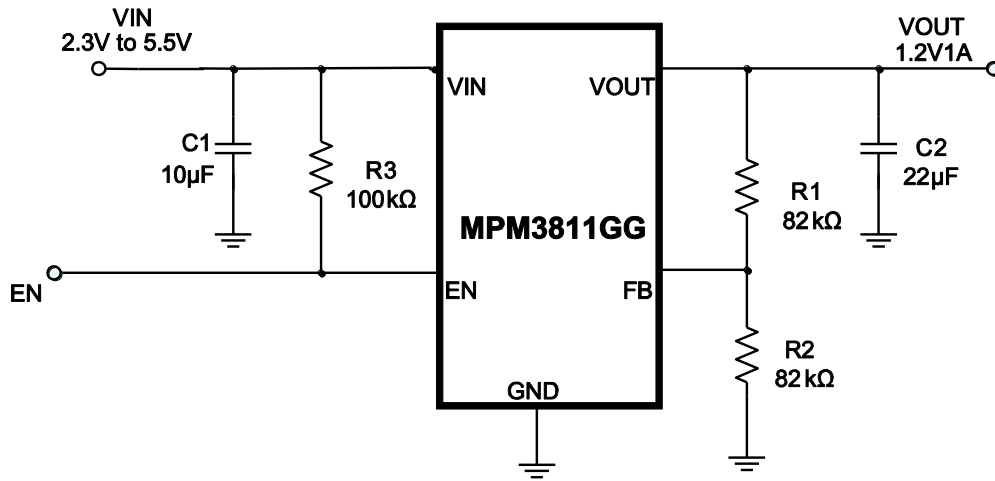

Figure 6: Typical Application Circuit for MPM3811GG

NOTE: $V_{IN} > V_{OUT}$ for application.

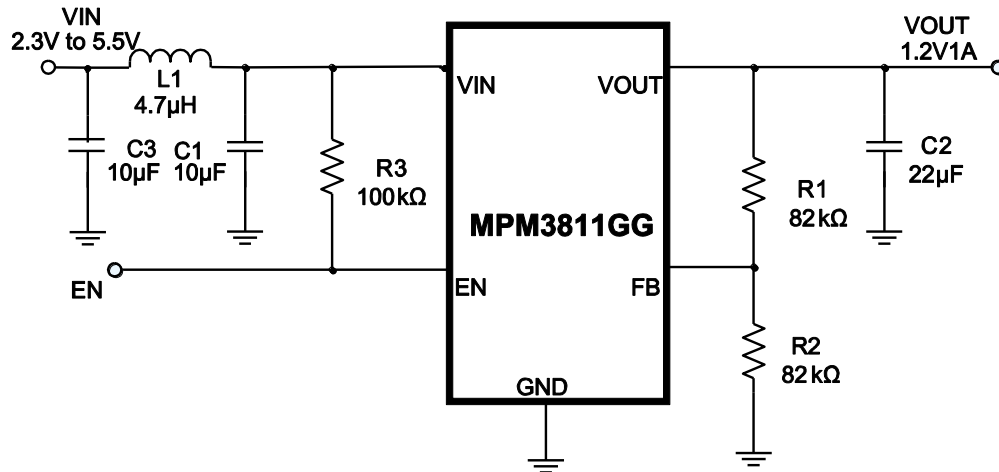
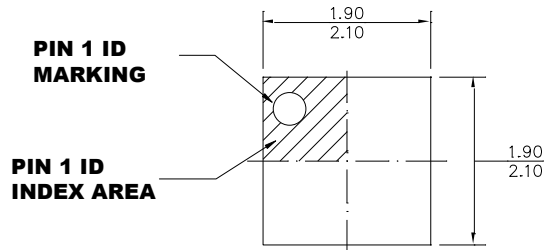

Figure 7: EMI Typical Application Circuit for EN55022 Class B

NOTE: $V_{IN} > V_{OUT}$ for application.

PACKAGE INFORMATION

QFN-10 (2mmx2mmx1.6mm)



TOP VIEW

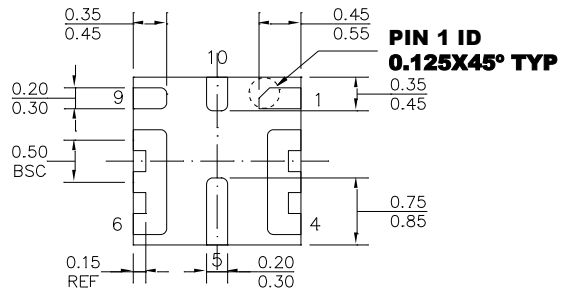

BOTTOM VIEW

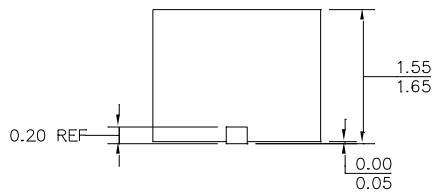

SIDE VIEW

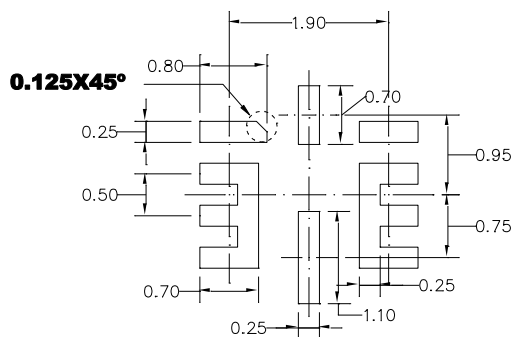

RECOMMENDED LAND PATTERN

NOTE:

- 1) ALL DIMENSIONS ARE IN MILLIMETERS.
- 2) LEAD COPLANARITY SHALL BE 0.10 MILLIMETERS MAX.
- 3) JEDEC REFERENCE IS MO-220.
- 4) DRAWING IS NOT TO SCALE.

NOTICE: The information in this document is subject to change without notice. Users should warrant and guarantee that third party Intellectual Property rights are not infringed upon when integrating MPS products into any application. MPS will not assume any legal responsibility for any said applications.