

Locating / Seating Pins • DIN 6321

22630.0045



Product Description

Cylindric locating pins for locating workpieces in toleranced holes and also to be used as stops and feet.
Flattened locating pin used to overcome differences in tolerances, between holes or to position an element in one direction only.
The bearing surface of the seating pin has no centre (picture 1).

Material

- Tool steel, hardened, ground

Drawing

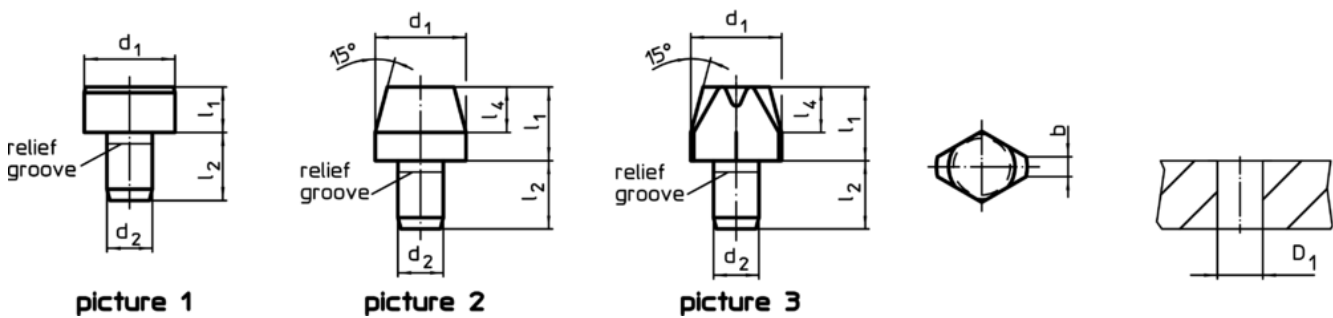

Order information

d ₁ g6	l ₁	Dimensions				Location hole D ₁ H7 [mm]	[g]	Art. No.
		b [mm]	d ₂ n6	l ₂	l ₄			
locating pin, flattened, DIN 6321, form C – picture 3								
10	18	2.5	6	9	6	6	8.9	22630.0045

Application example



Compliance

RoHS compliant

Compliant according to Directive 2011/65/EU and Directive 2015/863

Does not contain SVHC substances

No SVHC substances with more than 0.1% w/w contained - SVHC list [REACH] as of 10.06.2022

Does not contain Proposition 65 substances

No Proposition 65 substances included

<https://www.P65Warnings.ca.gov/>

Free from Conflict Minerals

This product does not contain any substances designated as "conflict minerals" such as tantalum, tin, gold or tungsten from the Democratic Republic of Congo or adjacent countries.