

# 690 Series



## Extruded Heat Sinks for TO Devices w/ Clip

- Wakefield-Vette's 690 series heat sinks are used for TO-126, 220, 247 Devices.
- Aluminum Extruded heat sink with integrated, robust holding feature.
- Easy installation for TO Devices.
- Optimal heat transfer between component and heat sink.
- Solderable retaining pin for PCB mounting.
- Material 6063-T5 Aluminum w/ Brass Pin, Black Anodized



Wakefield Part Number	Description	Length (mm)	Height (mm)	Width (mm)	Attachment Method	Package Cooled
692-25	HEATSINK, TO126, INTEGRATED CLIP, 25MM	25	27.94	10.92	Solder to PCB	TO126
692-50	HEATSINK, TO126, INTEGRATED CLIP, 50MM	50	27.94	10.92	Solder to PCB	TO126
692-75	HEATSINK, TO126, INTEGRATED CLIP, 75MM	75	27.94	10.92	Solder to PCB	TO126
692-100	HEATSINK, TO126, INTEGRATED CLIP, 100MM	100	27.94	10.92	Solder to PCB	TO126
693-25	HEATSINK, TO220, INTEGRATED CLIP, 25MM	25	35.05	22	Solder to PCB	TO220
693-50	HEATSINK, TO220, INTEGRATED CLIP, 50MM	50	35.05	22	Solder to PCB	TO220
693-75	HEATSINK, TO220, INTEGRATED CLIP, 75MM	75	35.05	22	Solder to PCB	TO220
693-100	HEATSINK, TO220, INTEGRATED CLIP, 100MM	100	35.05	22	Solder to PCB	TO220
694-25	HEATSINK, TO247, INTEGRATED CLIP, 25MM	25	35.05	22	Solder to PCB	TO247
694-50	HEATSINK, TO247, INTEGRATED CLIP, 50MM	50	35.05	22	Solder to PCB	TO247
694-75	HEATSINK, TO247, INTEGRATED CLIP, 75MM	75	35.05	22	Solder to PCB	TO247
694-100	HEATSINK, TO247, INTEGRATED CLIP, 100MM	100	35.05	22	Solder to PCB	TO247

## 692 Series

Wakefield Part Number	Description	Length (mm)	Height (mm)	Width (mm)	Attachment Method	Package Cooled
692-25	HEATSINK, TO126, INTEGRATED CLIP, 25MM	25	27.94	10.92	Solder to PCB	TO126
692-50	HEATSINK, TO126, INTEGRATED CLIP, 50MM	50	27.94	10.92	Solder to PCB	TO126
692-75	HEATSINK, TO126, INTEGRATED CLIP, 75MM	75	27.94	10.92	Solder to PCB	TO126
692-100	HEATSINK, TO126, INTEGRATED CLIP, 100MM	100	27.94	10.92	Solder to PCB	TO126

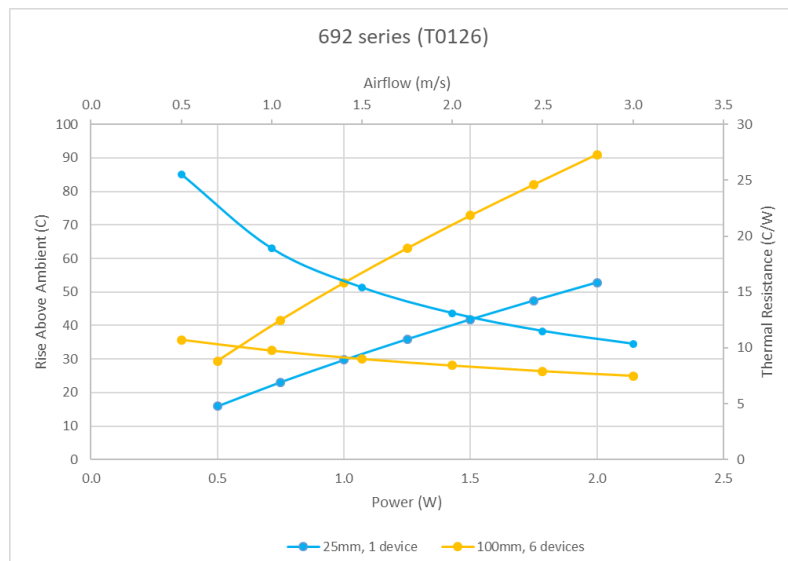
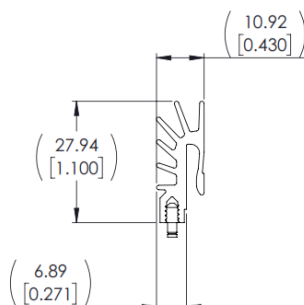
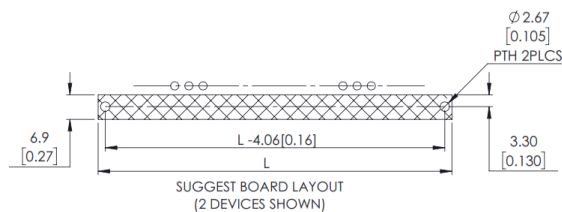

### 693 Series

Wakefield Part Number	Description	Length (mm)	Height (mm)	Width (mm)	Attachment Method	Package Cooled
693-25	HEATSINK, TO220, INTEGRATED CLIP, 25MM	25	35.05	22	Solder to PCB	TO220
693-50	HEATSINK, TO220, INTEGRATED CLIP, 50MM	50	35.05	22	Solder to PCB	TO220
693-75	HEATSINK, TO220, INTEGRATED CLIP, 75MM	75	35.05	22	Solder to PCB	TO220
693-100	HEATSINK, TO220, INTEGRATED CLIP, 100MM	100	35.05	22	Solder to PCB	TO220

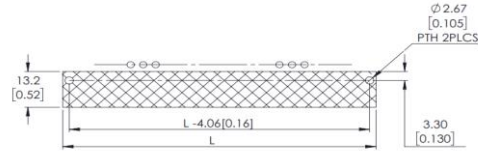
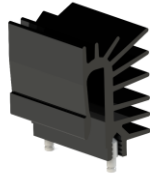

SUGGEST BOARD LAYOUT (2 DEVICES SHOWN)

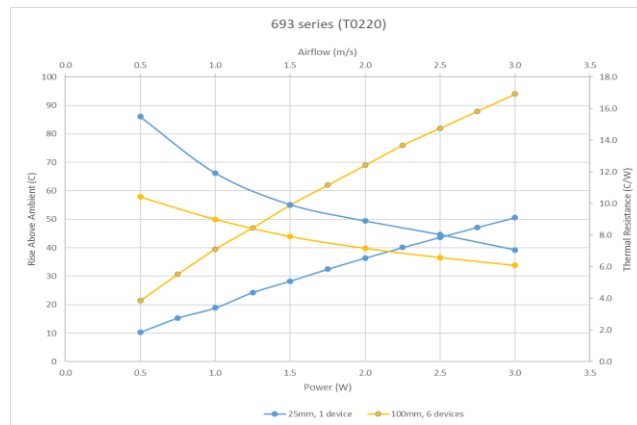
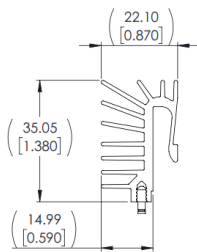

### 694 Series

Wakefield Part Number	Description	Length (mm)	Height (mm)	Width (mm)	Attachment Method	Package Cooled
694-25	HEATSINK, TO247, INTEGRATED CLIP, 25MM	25	35.05	22	Solder to PCB	TO247
694-50	HEATSINK, TO247, INTEGRATED CLIP, 50MM	50	35.05	22	Solder to PCB	TO247
694-75	HEATSINK, TO247, INTEGRATED CLIP, 75MM	75	35.05	22	Solder to PCB	TO247
694-100	HEATSINK, TO247, INTEGRATED CLIP, 100MM	100	35.05	22	Solder to PCB	TO247

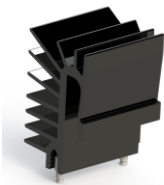

SUGGEST BOARD LAYOUT (2 DEVICES SHOWN)

