

REV.	DATE	ECR NO.	DESCRIPTION
NC	10/28/01	-	INITIAL RELEASE
A	02/15/09	-	UPDATE DRAWING FORMAT

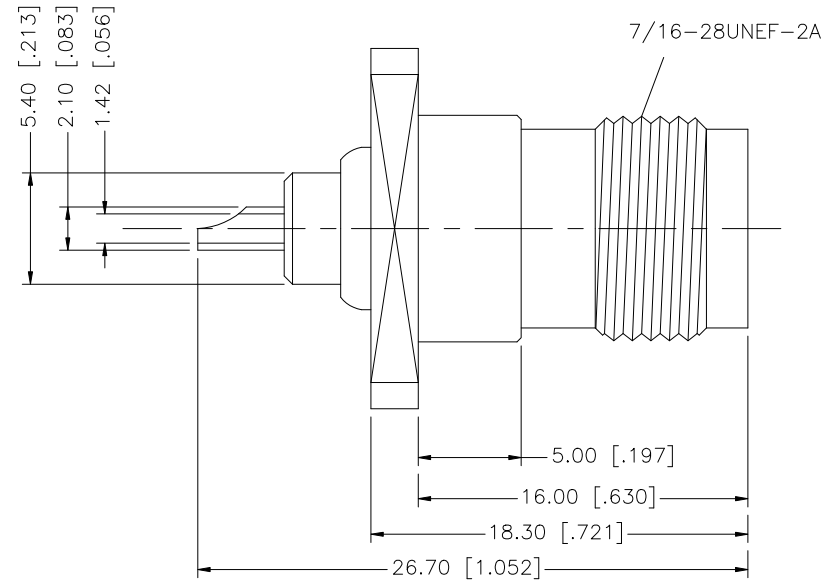
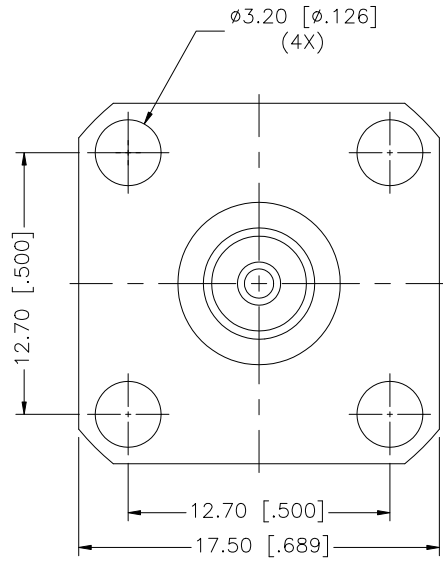

QTY	DESCRIPTION	MATERIAL	FINISH
1	BODY	BRASS	NICKEL
1	HOUSING	BRASS	NICKEL
1	INSULATOR	PTFE	NATURAL
1	CONTACT PIN	PHOS. BRONZE	GOLD

UNLESS OTHERWISE SPECIFIED DIMENSIONS ARE IN MILLIMETERS. DIMENSIONS IN [] ARE IN INCHES AND FOR CUSTOMER REFERENCE ONLY.

UNLESS OTHERWISE SPECIFIED TOLERANCES FOR MILLIMETERS ARE:
0.5 - 8mm ± 0.20mm
8 - 30mm ± 0.40mm
30 - 120mm ± 0.50mm

UNLESS OTHERWISE SPECIFIED TOLERANCES FOR INCHES ARE:
.020 - .315 = ± 0.007"
.315 - 1.180 = ± 0.015"
1.180 - 4.724 = ± 0.020"

DO NOT SCALE DRAWING

APPROVALS	DATE
DRAWN GRS	02/15/09
CHECKED	
ISSUED	
SHEET 1 OF 1	
CAD FILE	C:/122/122248.DWG

<h1>Amphenol Connex</h1>			
PART DESCRIPTION TNC PANEL JACK - 50 Ohms			
PART NO. 122248			
DWG. NO.	122248.DWG	REV. A	SCALE NA