



TAOGLAS®



Datasheet

Apex Black Right Angle TG.30 Wideband 5G/4G Antenna

Part No:
TG.30.8112

Features:

- 600-6000MHz
- Covers 5G/4G Bands
- Typical 50%+ Efficiency and 3dBi+ Peak Gain
- Dipole Terminal Antenna
- 90° termination with SMA(M) Connector
- RoHS and REACH Compliant

1. Introduction	3
2. Specifications	4
3. Antenna Characteristics	7
4. Radiation Patterns	9
5. Mechanical Drawing	75
6. Packaging	76
<hr/>	
Changelog	77

Taoglas makes no warranties based on the accuracy or completeness of the contents of this document and reserves the right to make changes to specifications and product descriptions at any time without notice. Taoglas reserves all rights to this document and the information contained herein. Reproduction, use or disclosure to third parties without express permission is strictly prohibited.



1. Introduction



The Apex TG.30 is a Wideband Dipole 5G/4G Antenna – is primarily designed for use with 5G/4G LTE modules, routers and devices that require the highest possible efficiency and peak gain to deliver best in class throughput on all major cellular bands worldwide between 600MHz and 6GHz.

This fixed 90 degree, connector mount, dipole antenna is primarily designed for use with 5G/4G LTE modules and devices that require the highest possible efficiency and peak gain in order to deliver best-in-class throughput.

Typical Applications include:

- Routers and Gateways
- Access Points
- Remote Monitoring

With very high efficiency on every cellular band globally it is an ideal solution for any device requiring high, reliable performance. It is also guaranteed to meet any type approval or carrier certification requirements from a RF standpoint.

It is an omni-directional antenna and the radiation patterns display this and are stable across all bands. It also has a quality robust UV resistant housing for use with wireless terminals.

This patented antenna is available in White and Black versions. The antenna blade can swivel 90 degrees from the connector accommodating different installation environments. It is also available with Straight and Right Angle connectors.

For further information please contact your regional Taoglas customer support team.

2. Specifications

5G/4G Electrical								
Band	Frequency (MHz)		Efficiency (%)	Average Gain (dB)	Peak Gain (dBi)	VSWR	Impedance	Polarization
5G NR/4G Band 5,8,12,13,14,17,18,20,26,27,28, 29,71	617~960	Freespace	57	-2.8	2.6	3 Max	50Ω	Linear
		Edge_30X30cm_GP	53	-3.1	2.8			
		Centre_30X30cm_GP	19	-7.7	1.4			
5G NR/4G Band 21,32,74,75,76	1427~1518	Freespace	50	-3.3	5.6			
		Edge_30X30cm_GP	66	-2.0	2.5			
		Centre_30X30cm_GP	67	-2.0	7.2			
4G/3G Band 1,2,3,4,9,23,25,35,39,66	1710~2200	Freespace	80	-1.0	4.3			
		30X30cm_GP	66	-1.8	3.0			
		Centre_30X30cm_GP	64	-1.9	7.8			
Wi-Fi 2400	2400~2500	Freespace	68	-1.7	4.2			
		Edge_30X30cm_GP	62	-2.1	3.9			
		Centre_30X30cm_GP	31	-5.1	3.1			
4G/3G Band 7,38,41	2490~2690	Freespace	69	-1.6	4.4			
		Edge_30X30cm_GP	50	-2.9	4.6			
		Centre_30X30cm_GP	56	-2.7	7.1			
5G NR/4G Band 22,42,43,48,77,78	3300~3800	Freespace	63	-2.2	6.5			
		Edge_30X30cm_GP	48	-3.7	5.5			
		Centre_30X30cm_GP	43	-4.2	6.8			
LTE5200/ Wi-Fi 5800	5150~5925	Freespace	66	-1.9	5.7			
		Edge_30X30cm_GP	42	-3.9	4.7			
		Centre_30X30cm_GP	35	-4.9	7.1			
Mechanical								
Casing	UV Resistant PC/ABS							
Flammability Rating	UL-94							
Connector	SMA Male							
Environmental								
Temperature Range	-40°C to 85°C							
Humidity	Non-condensing 65°C 95% RH							

5G/4G Bands			
Band Number	5GNR / FR1 / LTE / LTE-Advanced / WCDMA / HSPA / HSPA+ / TD-SCDMA		
	Uplink	Downlink	Covered
1	UL: 1920 to 1980	DL: 2110 to 2170	✓
2	UL: 1850 to 1910	DL: 1930 to 1990	✓
3	UL: 1710 to 1785	DL: 1805 to 1880	✓
4	UL: 1710 to 1755	DL: 2110 to 2155	✓
5	UL: 824 to 849	DL: 869 to 894	✓
7	UL: 2500 to 2570	DL: 2620 to 2690	✓
8	UL: 880 to 915	DL: 925 to 960	✓
9	UL: 1749.9 to 1784.9	DL: 1844.9 to 1879.9	✓
11	UL: 1427.9 to 1447.9	DL: 1475.9 to 1495.9	✓
12	UL: 699 to 716	DL: 729 to 746	✓
13	UL: 777 to 787	DL: 746 to 756	✓
14	UL: 788 to 798	DL: 758 to 768	✓
17	UL: 704 to 716	DL: 734 to 746	✓
18	UL: 815 to 830	DL: 860 to 875	✓
19	UL: 830 to 845	DL: 875 to 890	✓
20	UL: 832 to 862	DL: 791 to 821	✓
21	UL: 1447.9 to 1462.9	DL: 1495.9 to 1510.9	✓
22	UL: 3410 to 3490	DL: 3510 to 3590	✓
23	UL: 2000 to 2020	DL: 2180 to 2200	✓
24	UL: 1625.5 to 1660.5	DL: 1525 to 1559	✓
25	UL: 1850 to 1915	DL: 1930 to 1995	✓
26	UL: 814 to 849	DL: 859 to 894	✓
27	UL: 807 to 824	DL: 852 to 869	✓
28	UL: 703 to 748	DL: 758 to 803	✓
29	UL: -	DL: 717 to 728	✓
30	UL: 2305 to 2315	DL: 2350 to 2360	✓
31	UL: 452.5 to 457.5	DL: 462.5 to 467.5	✗
32	UL: -	DL: 1452 - 1496	✓
35		1850 to 1910	✓
38		2570 to 2620	✓
39		1880 to 1920	✓
40		2300 to 2400	✓
41		2496 to 2690	✓
42		3400 to 3600	✓
43		3600 to 3800	✓
48		3550 to 3700	✓
66	UL: 1710-1780	DL: 2110-2200	✓
71		617 to 698	✓
74/75/76		1427 to 1518	✓
78		3300 to 3800	✓
79		4400 to 5000	✗
85	698-716	728-746	✓

3. Antenna Characteristics

3.1 Return Loss

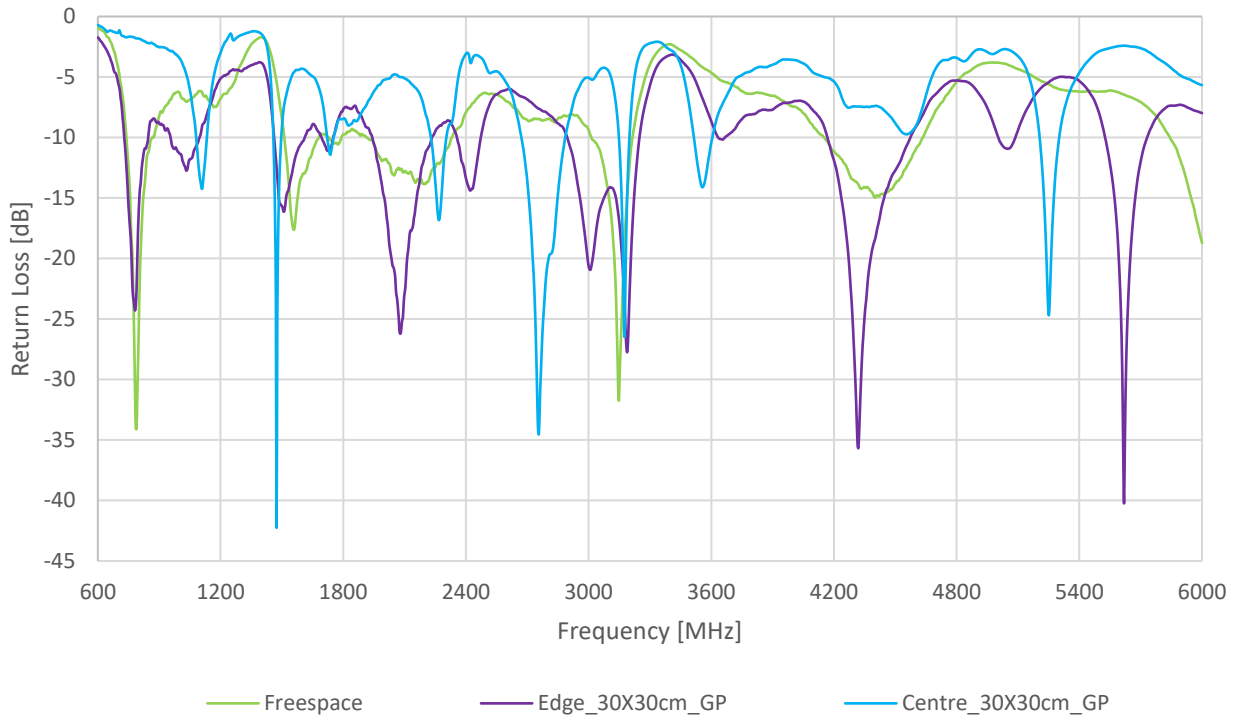

3.2 Efficiency

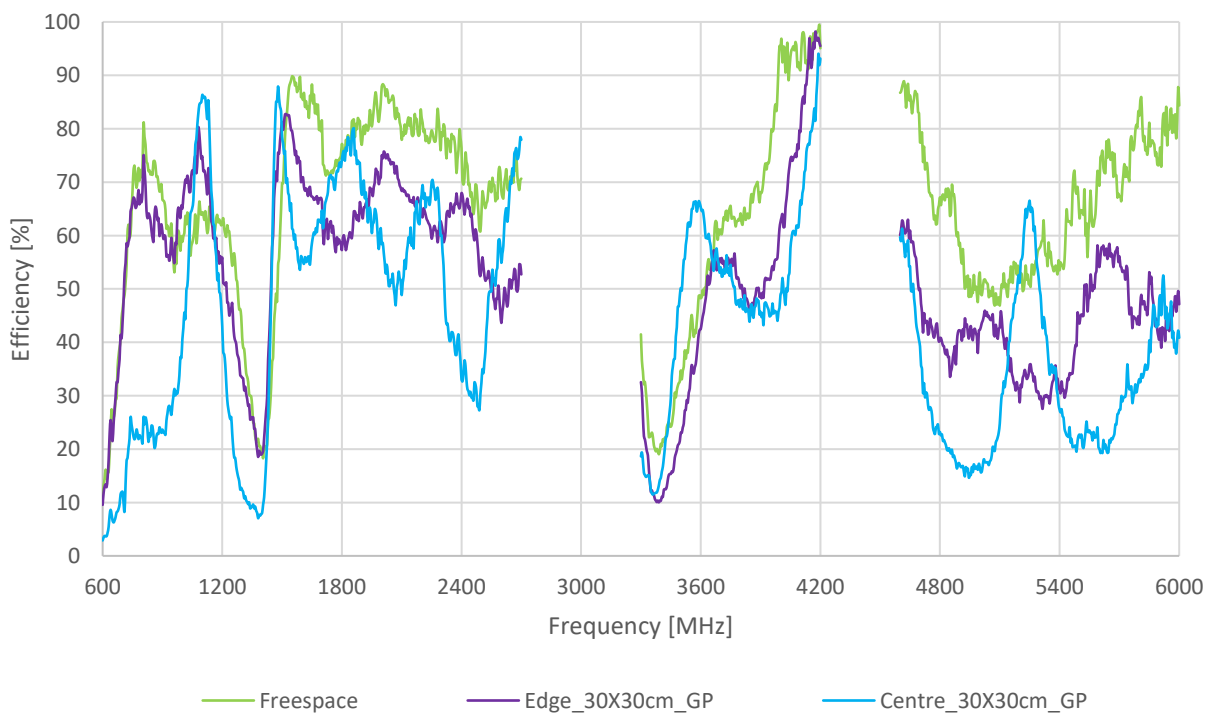

3.3 Average Gain

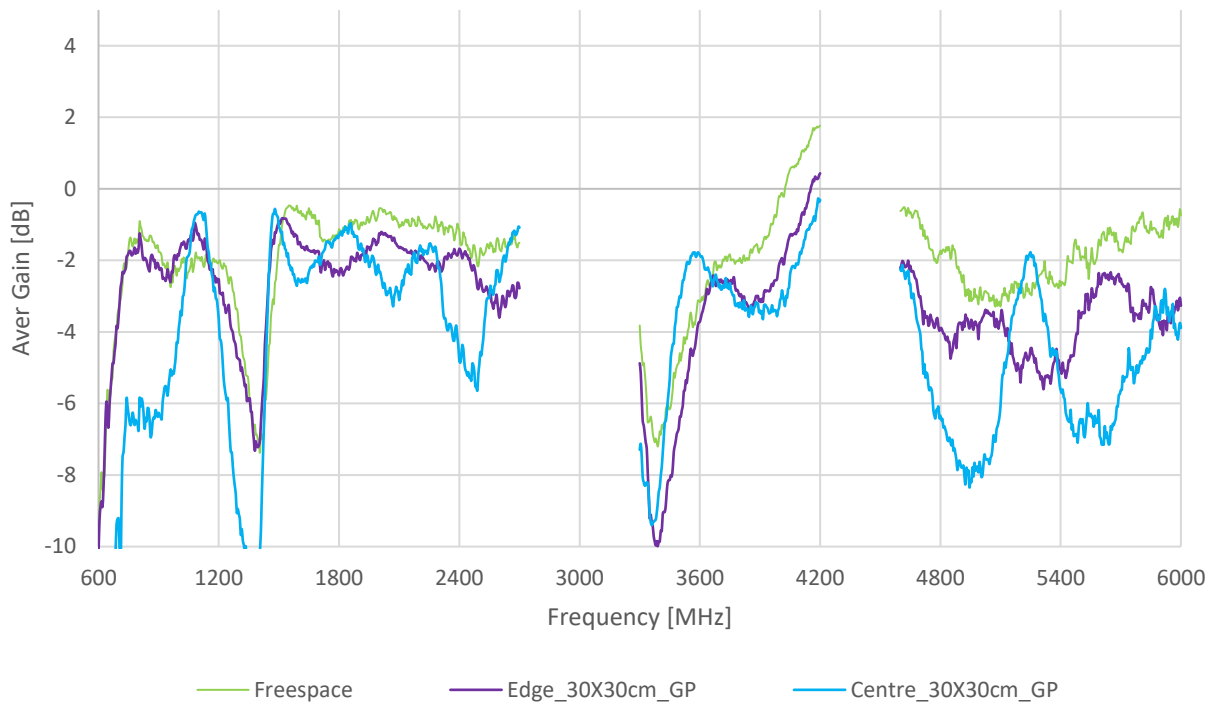

3.4 Peak Gain

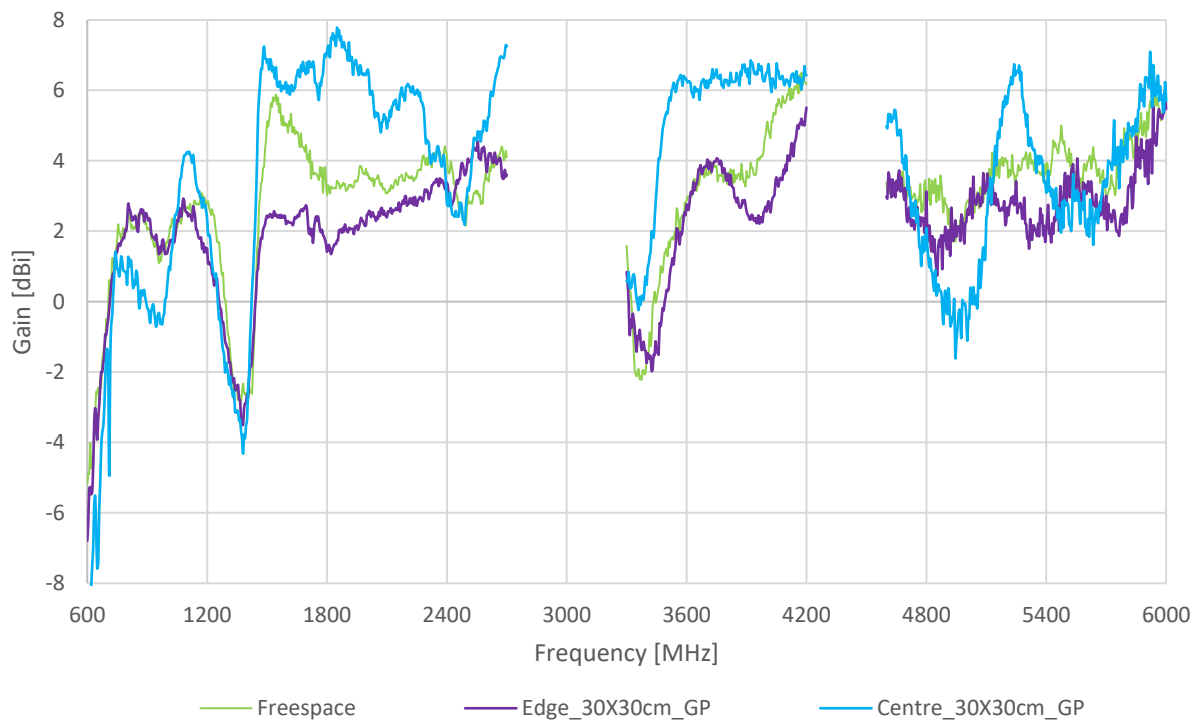

4. Radiation Patterns

4.1 Test Setup – Freespace

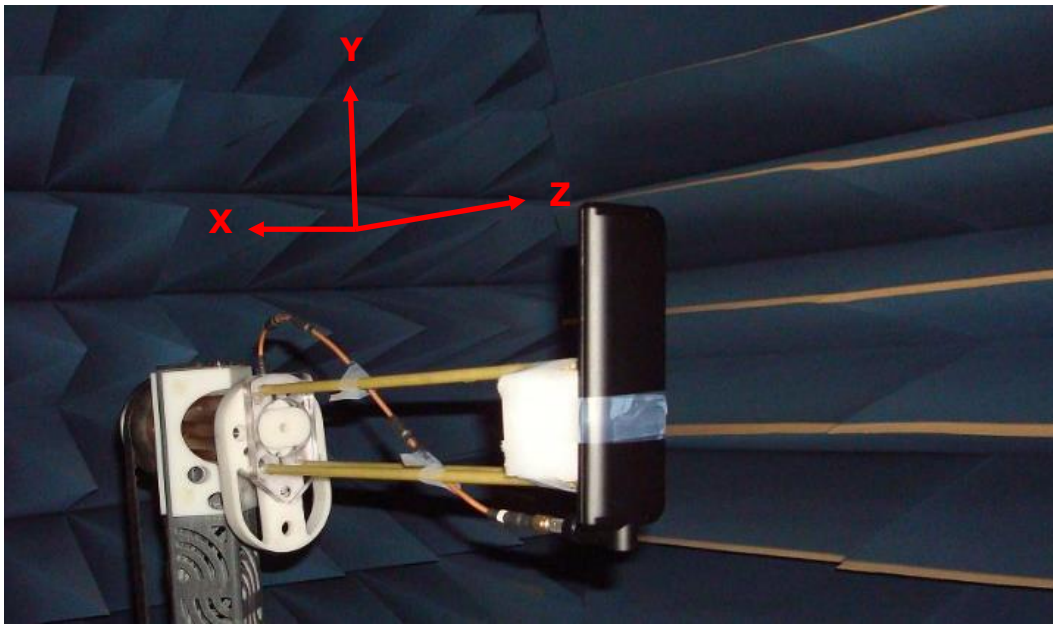

4.2 650MHz _Freespace 2D & 3D Radiation Patterns

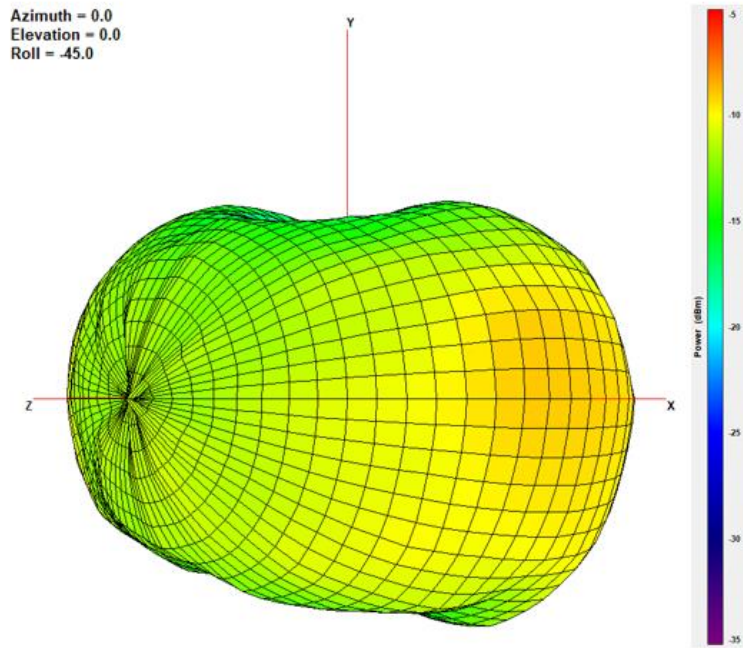

XY Plane

XZ Plane

YZ Plane

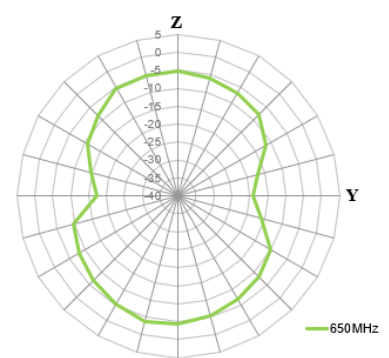
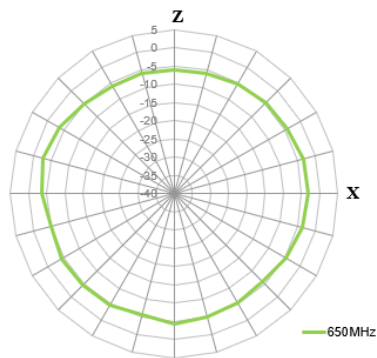
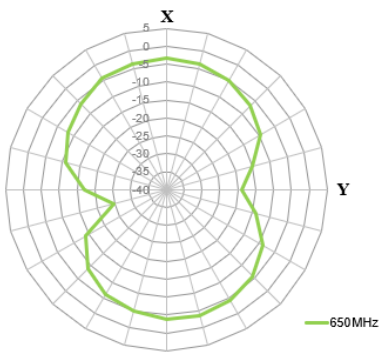

750MHz

Azimuth = 0.0
Elevation = 0.0
Roll = -45.0

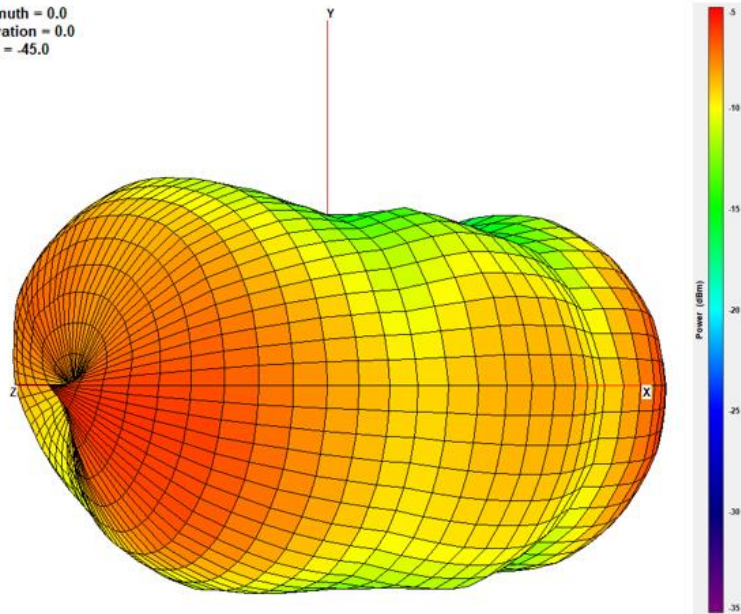

XY Plane

XZ Plane

YZ Plane

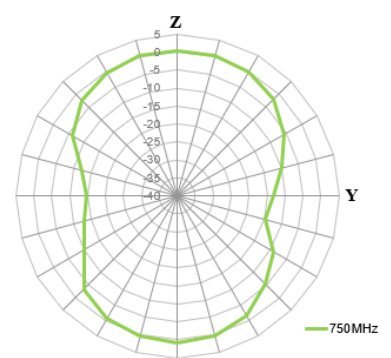
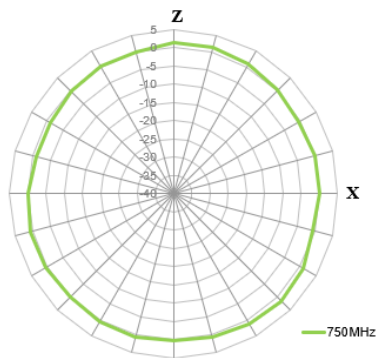
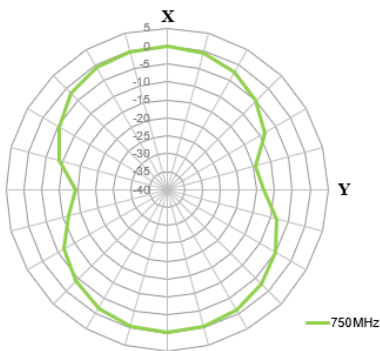

890MHz

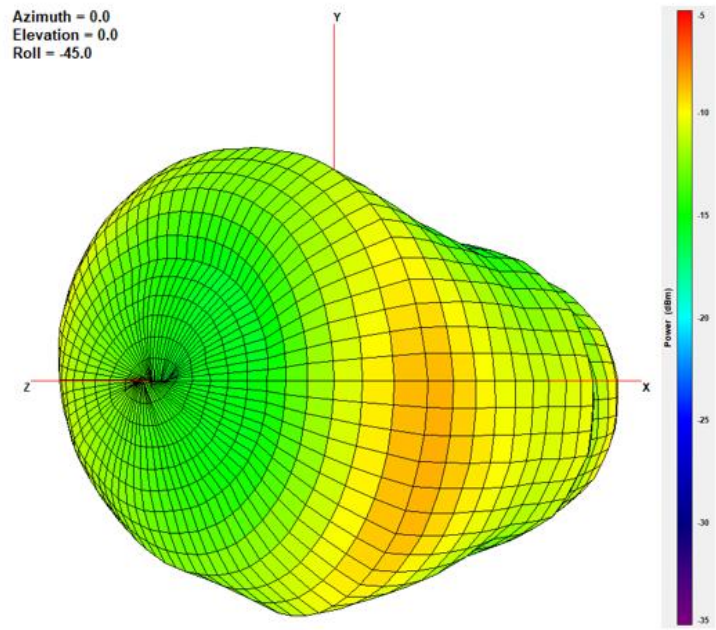

XY Plane

XZ Plane

YZ Plane

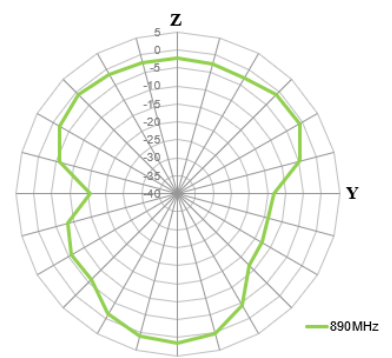
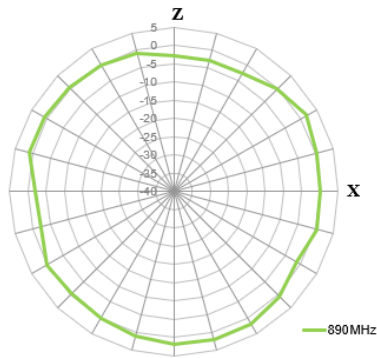
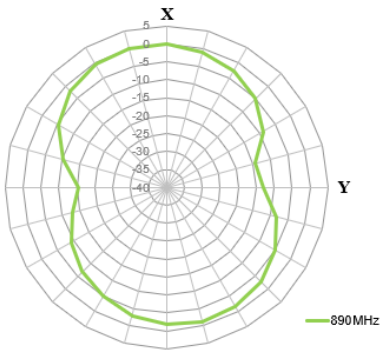

1470MHz

Azimuth = 0.0
Elevation = 0.0
Roll = -45.0

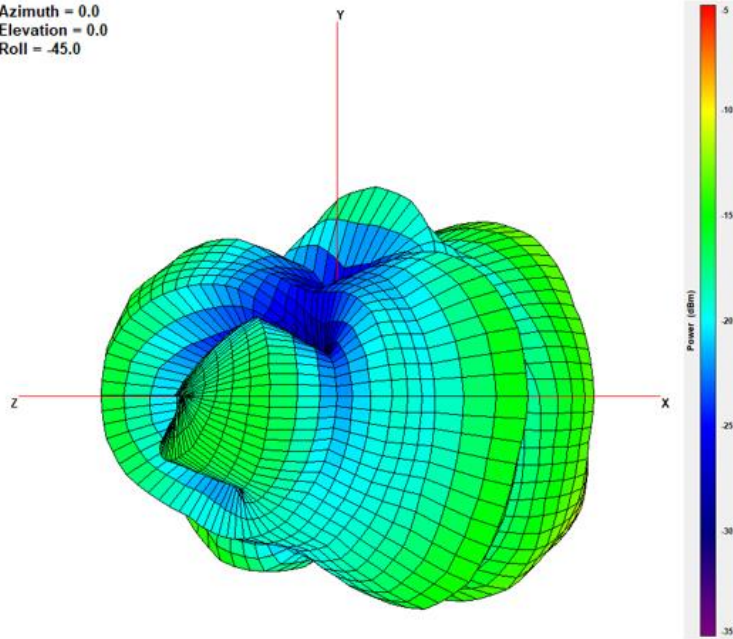

XY Plane

XZ Plane

YZ Plane

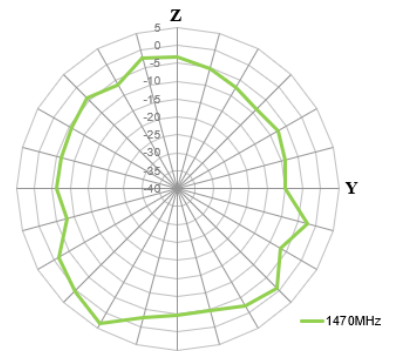
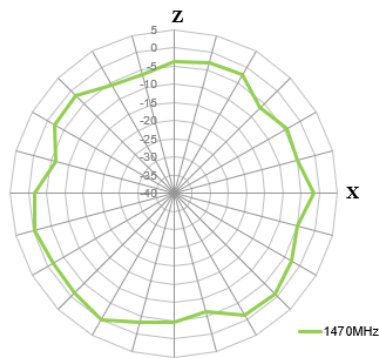
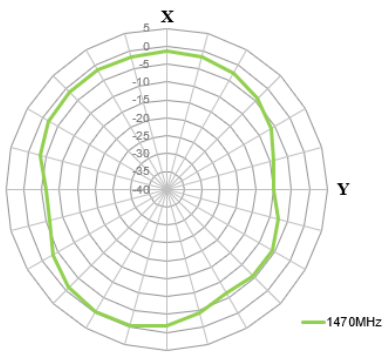

1805MHz

Azimuth = 0.0
Elevation = 0.0
Roll = -45.0

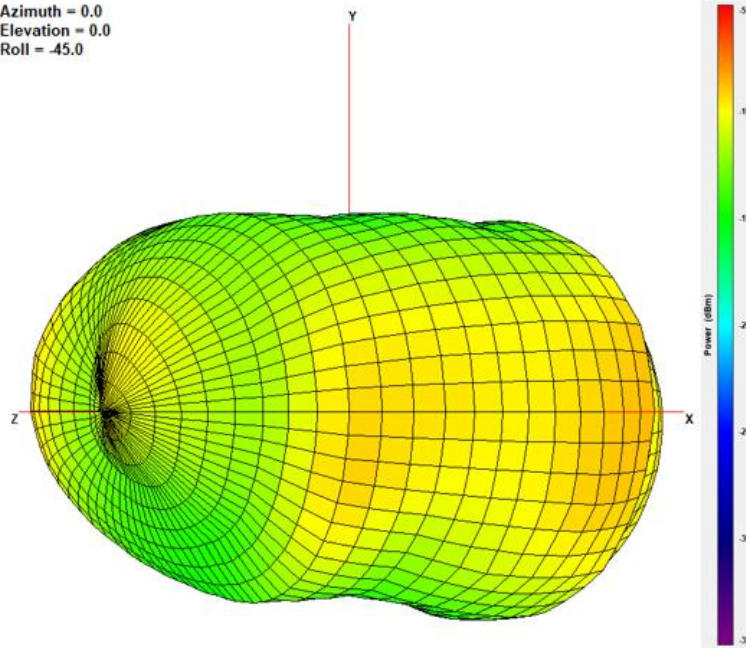

XY Plane

XZ Plane

YZ Plane

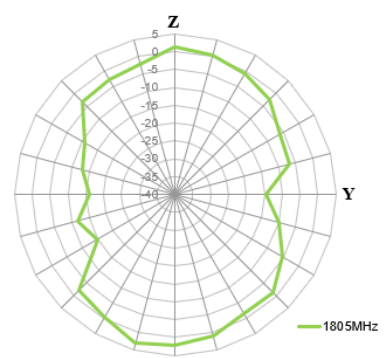
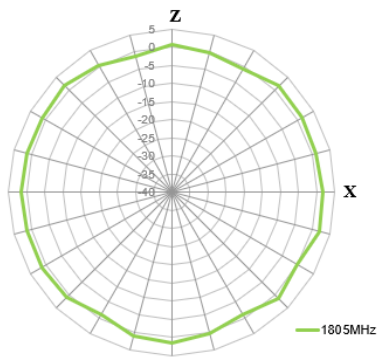
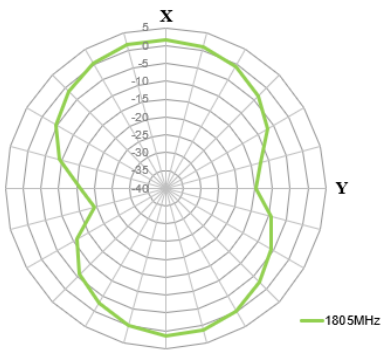

1920MHz

Azimuth = 0.0
Elevation = 0.0
Roll = -45.0

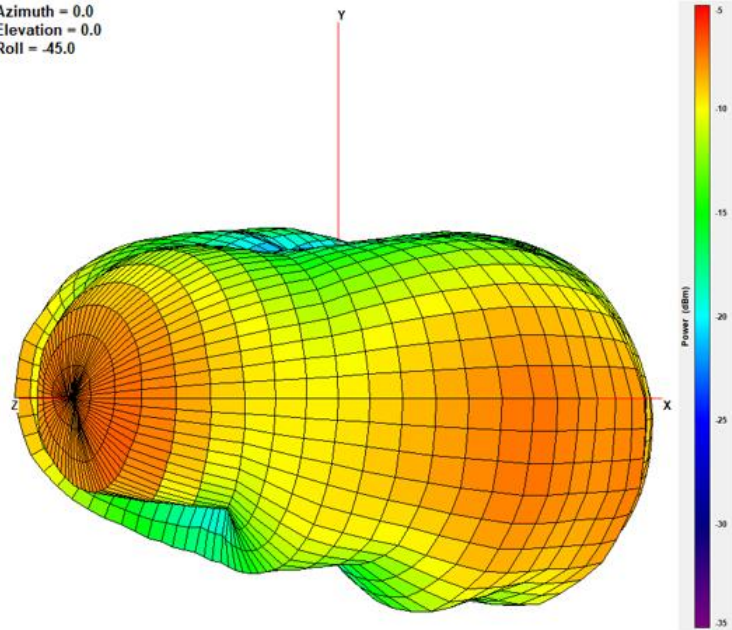

XY Plane

XZ Plane

YZ Plane

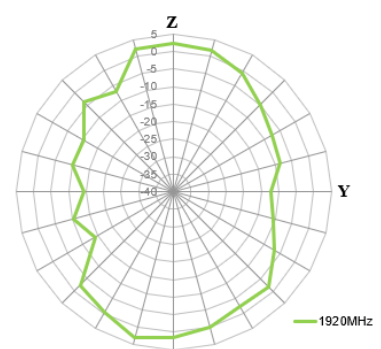
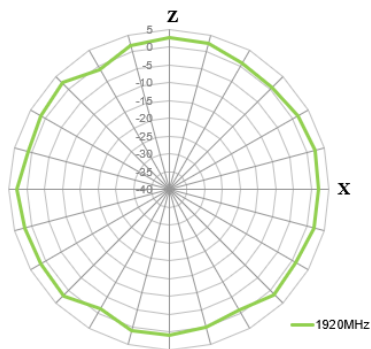
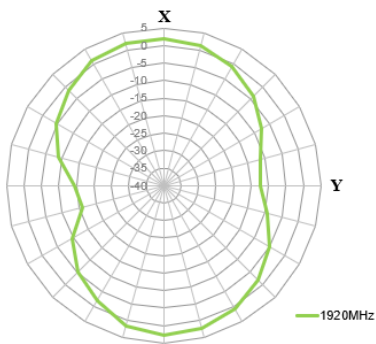

1990MHz

Azimuth = 0.0
Elevation = 0.0
Roll = -45.0

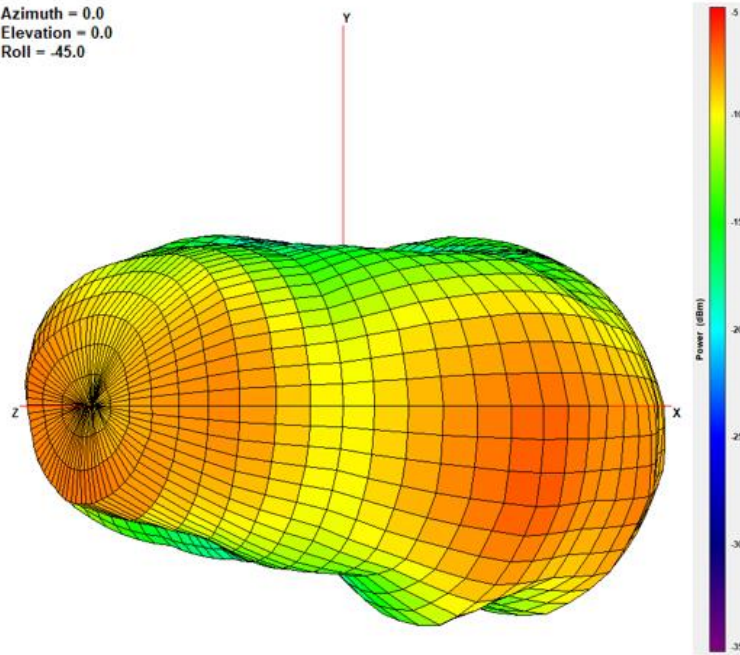

XY Plane

XZ Plane

YZ Plane

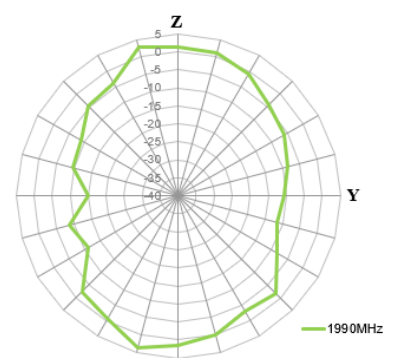
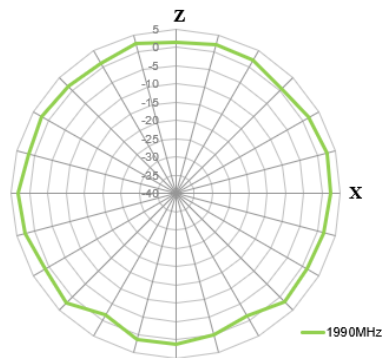
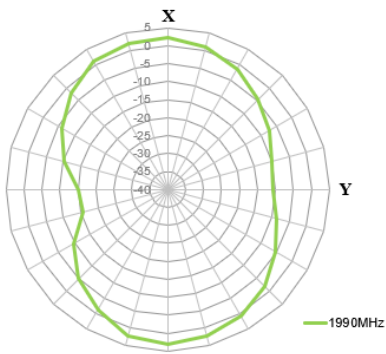

2595MHz

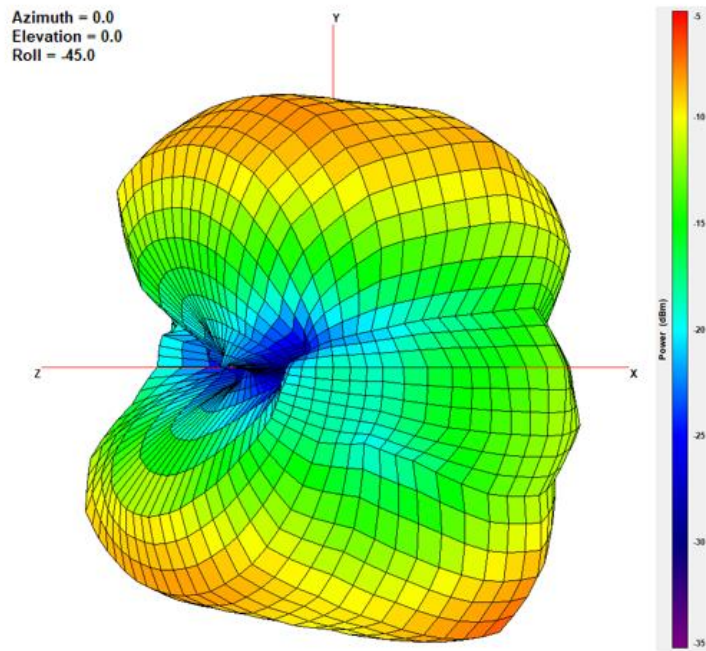

XY Plane

XZ Plane

YZ Plane

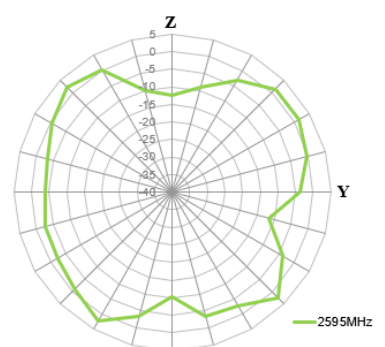
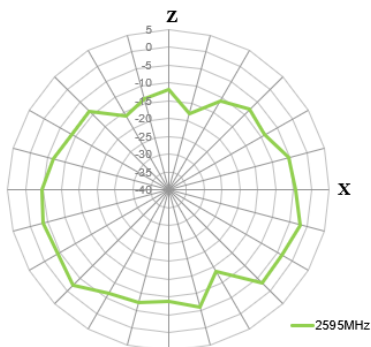
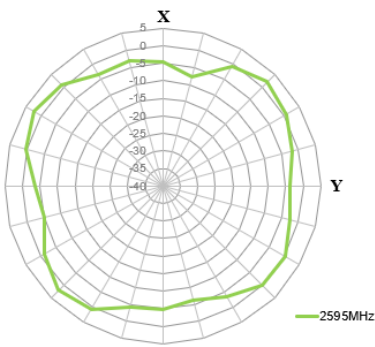

3550MHz

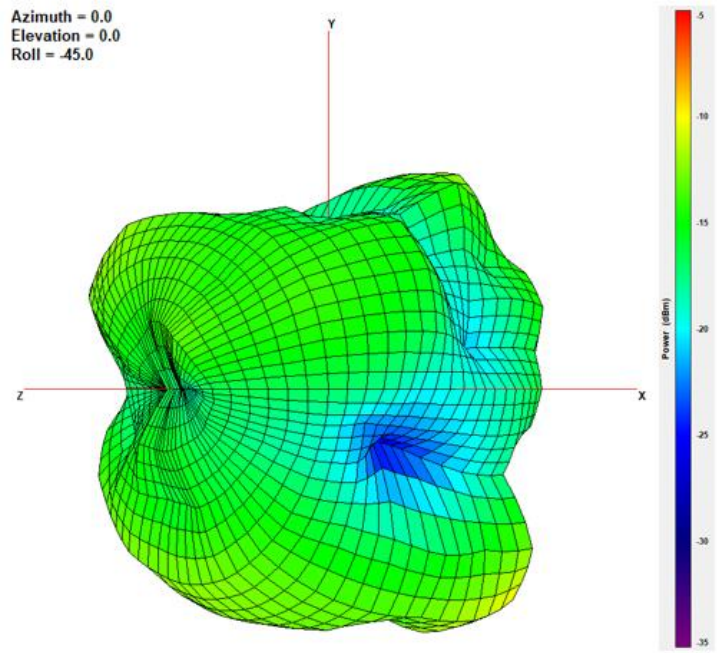

XY Plane

XZ Plane

YZ Plane

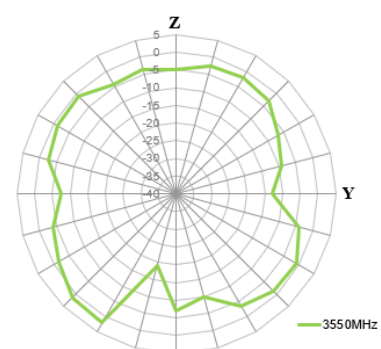
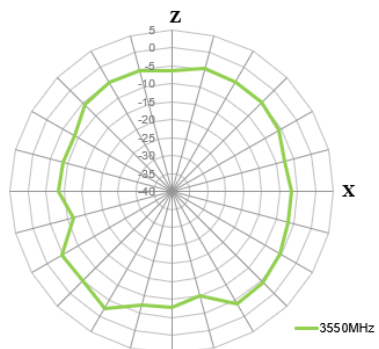
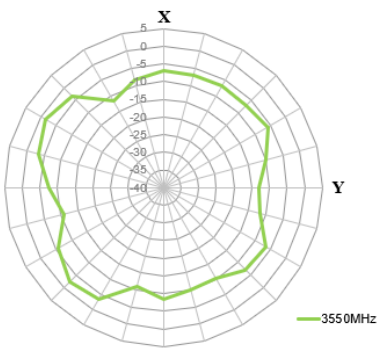

5530MHz

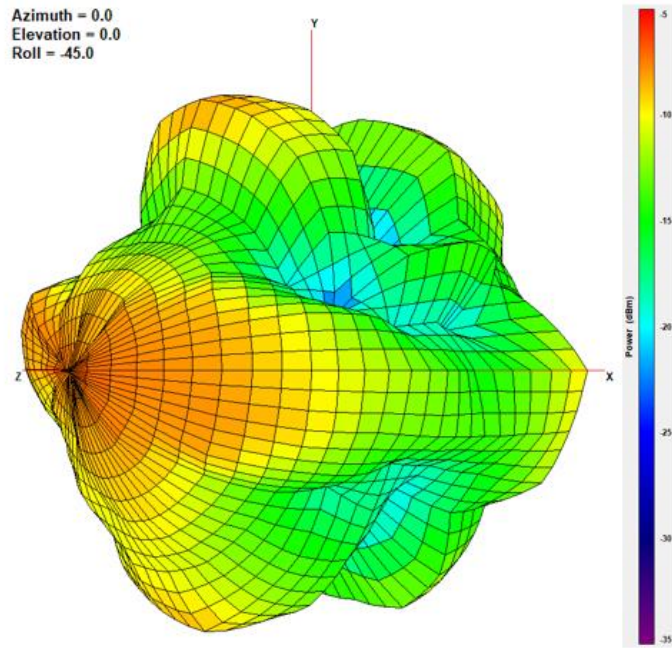

XY Plane

XZ Plane

YZ Plane

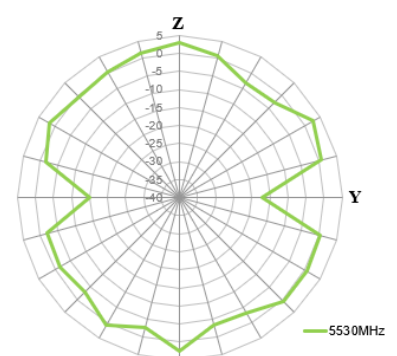
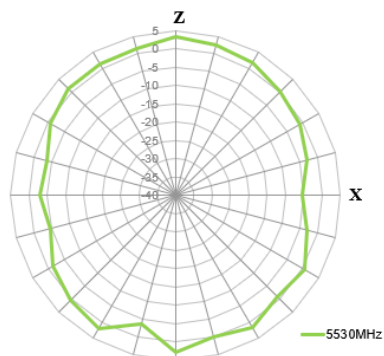
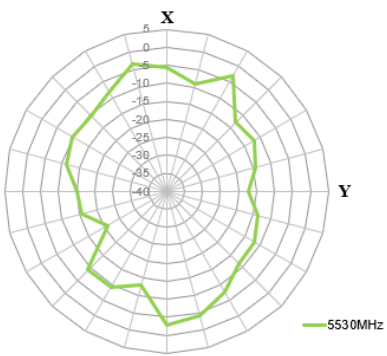

4.3 Test Setup –Edge_30X30cm_Ground plane

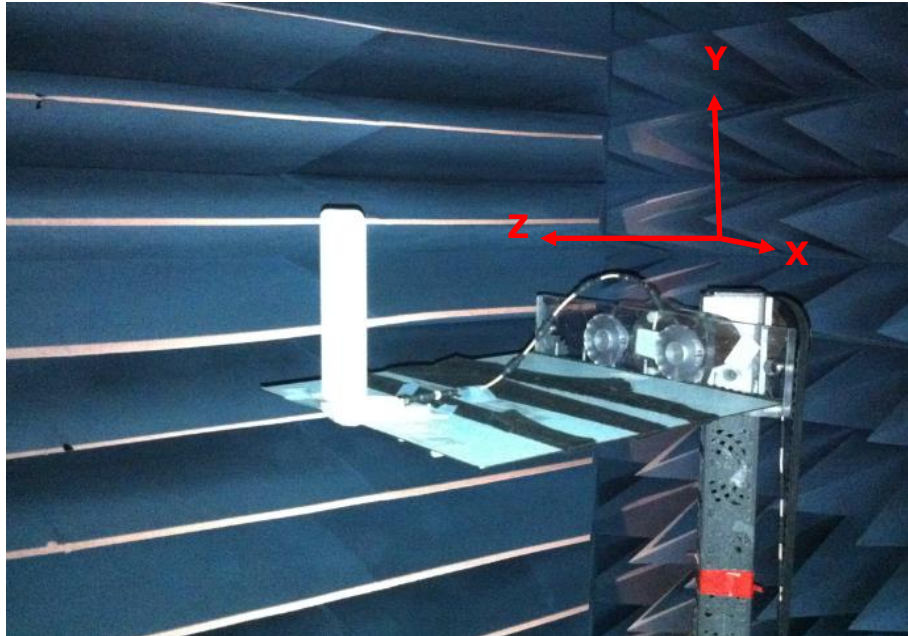

4.4 650MHz - Edge_30X30cm_Ground plane 2D & 3D Radiation Patterns

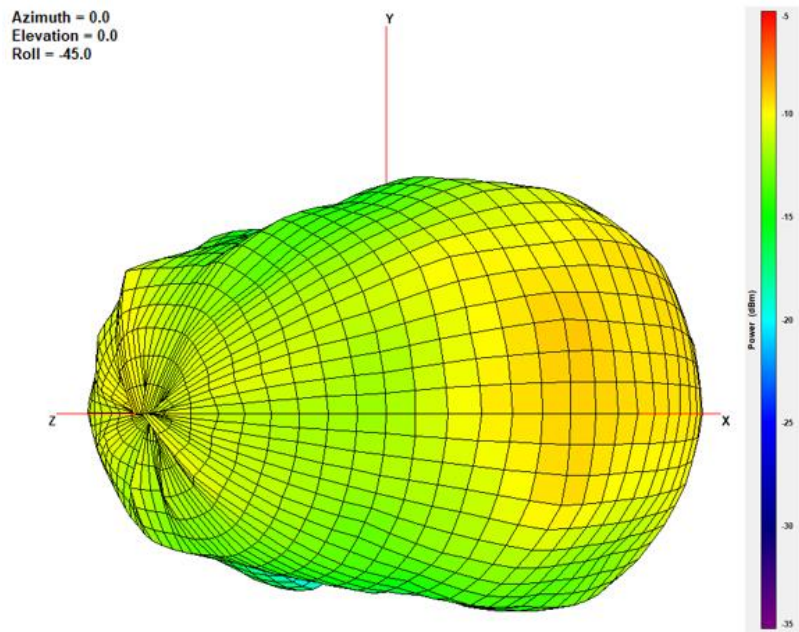

XY Plane

XZ Plane

YZ Plane

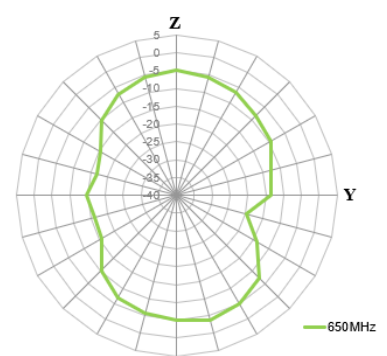
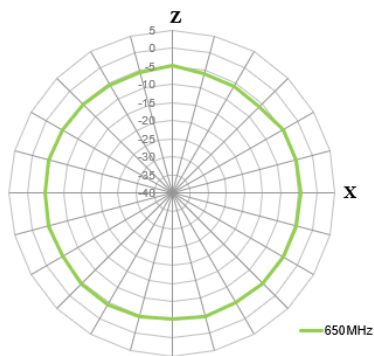
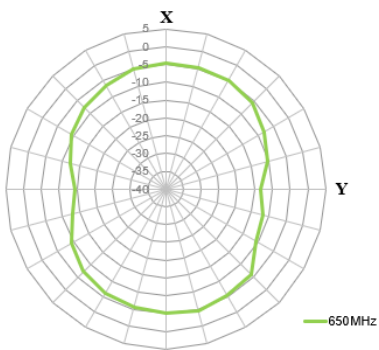

750MHz

Azimuth = 0.0
Elevation = 0.0
Roll = -45.0

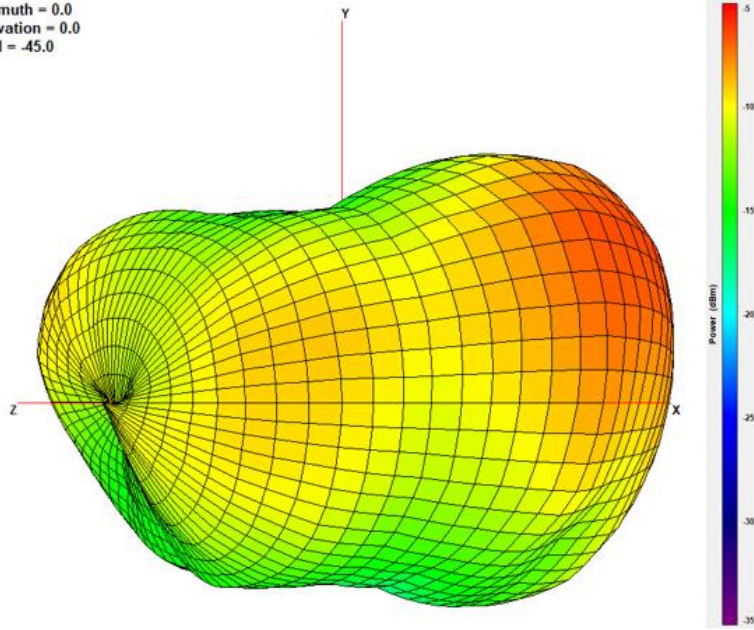

XY Plane

XZ Plane

YZ Plane

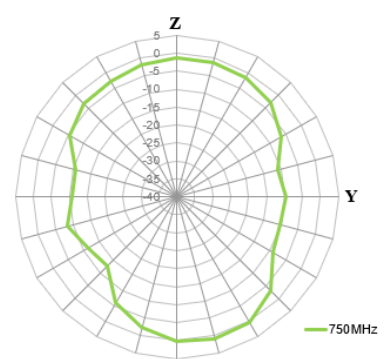
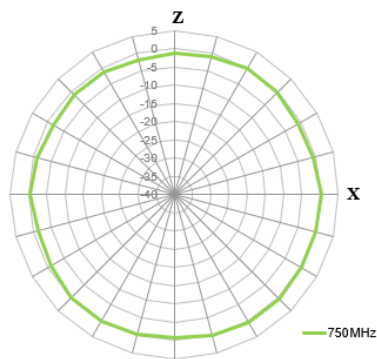
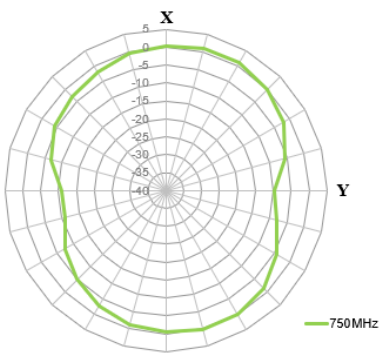

890MHz

Azimuth = 0.0
 Elevation = 0.0
 Roll = -45.0

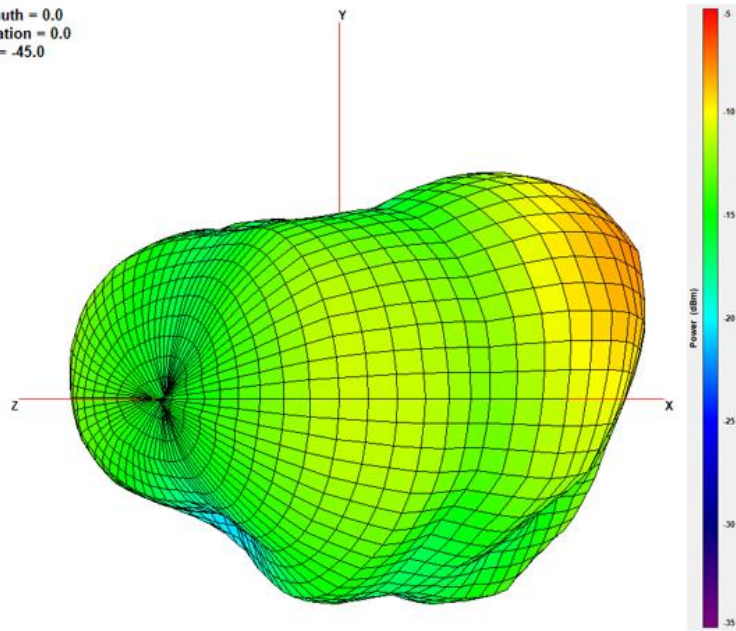

XY Plane

XZ Plane

YZ Plane

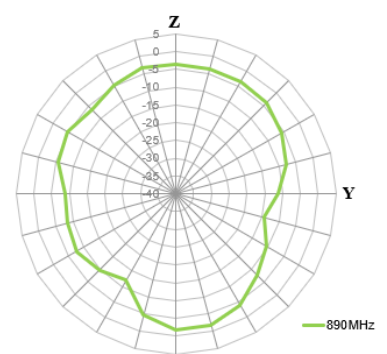
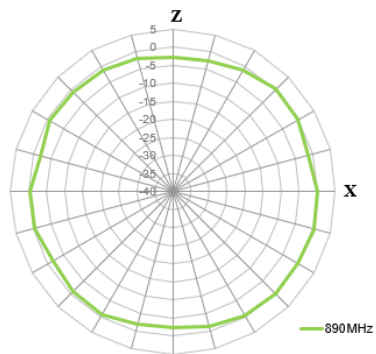
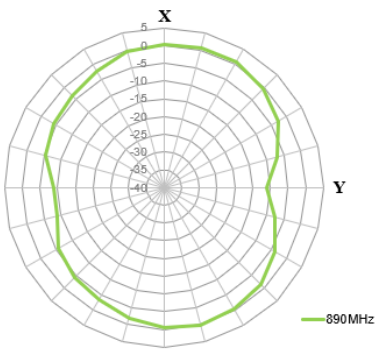

1470MHz

Azimuth = 0.0
 Elevation = 0.0
 Roll = -45.0

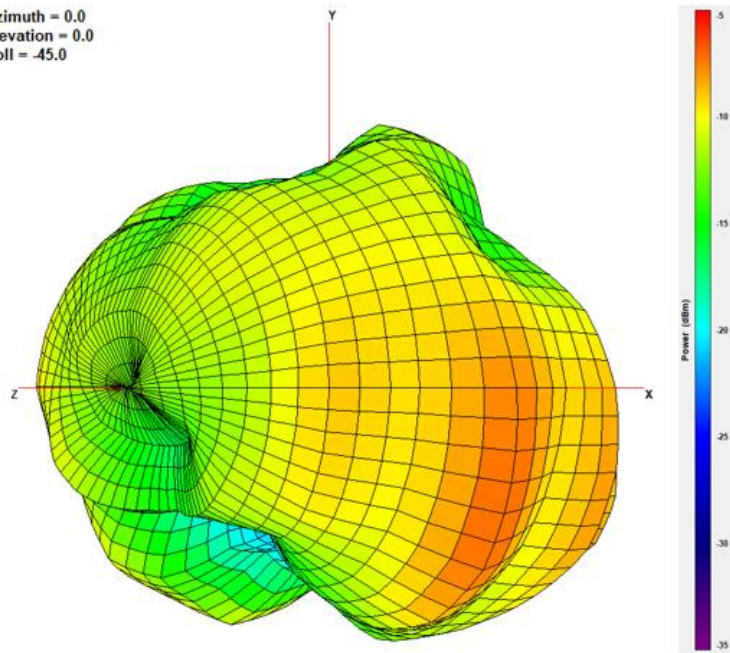

XY Plane

XZ Plane

YZ Plane

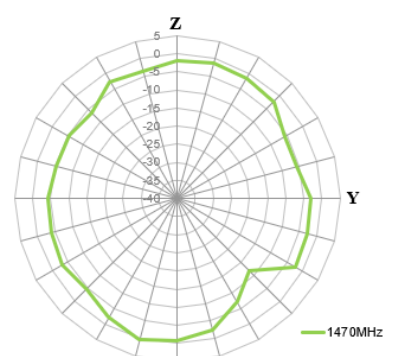
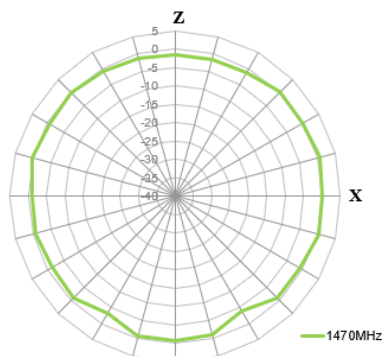
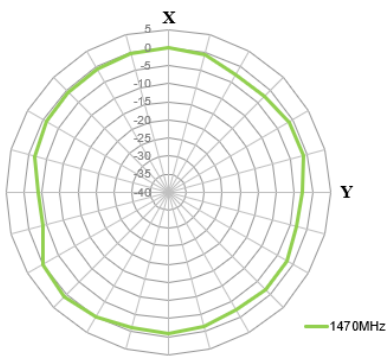

1805MHz

Azimuth = 0.0
Elevation = 0.0
Roll = -45.0

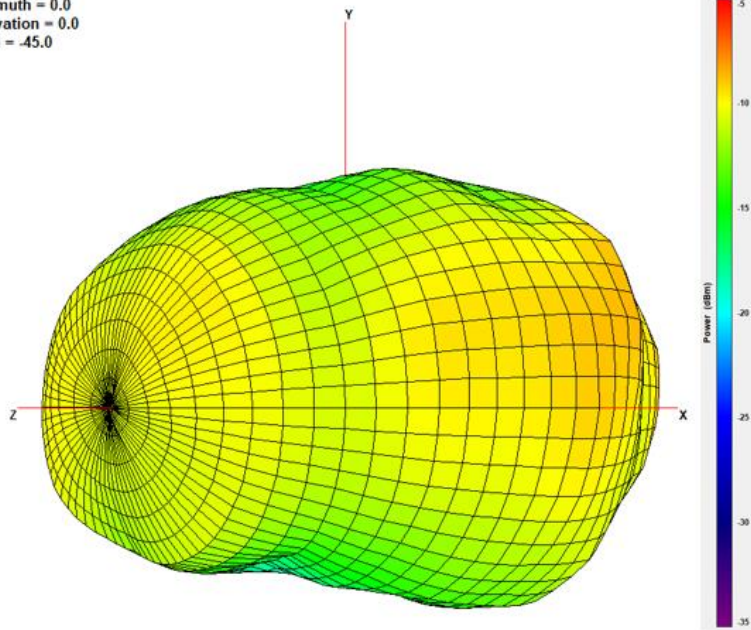

XY Plane

XZ Plane

YZ Plane

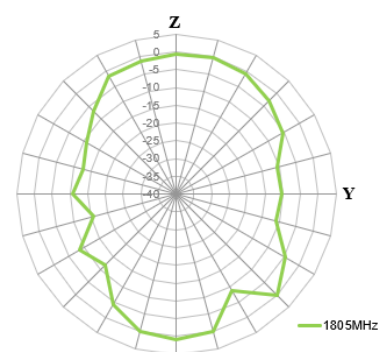
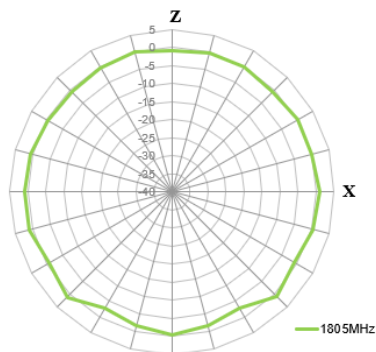
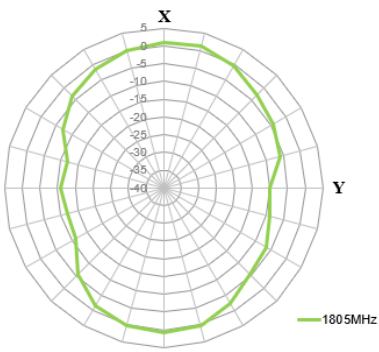

1920MHz

Azimuth = 0.0
Elevation = 0.0
Roll = -45.0

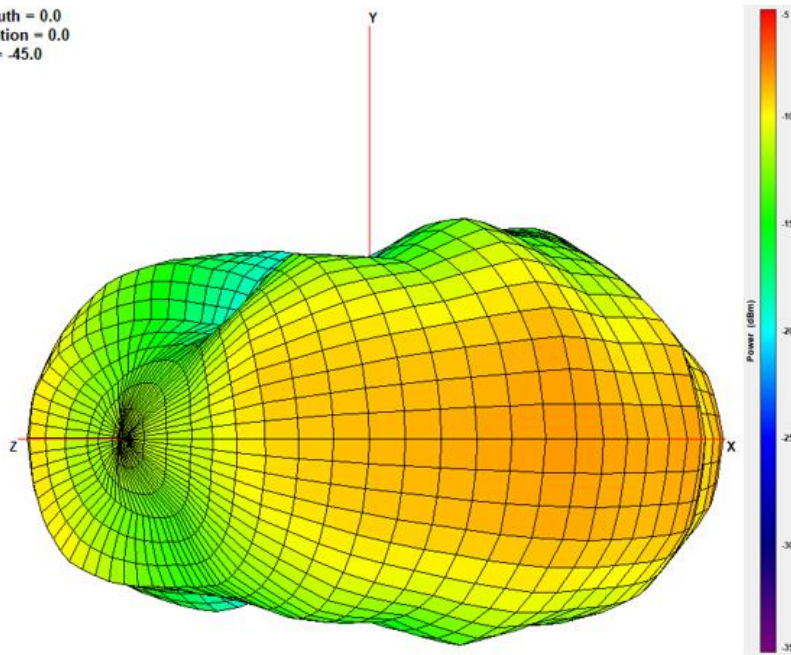

XY Plane

XZ Plane

YZ Plane

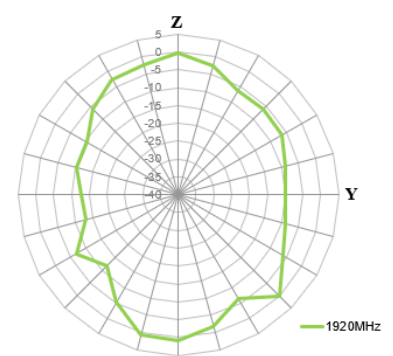
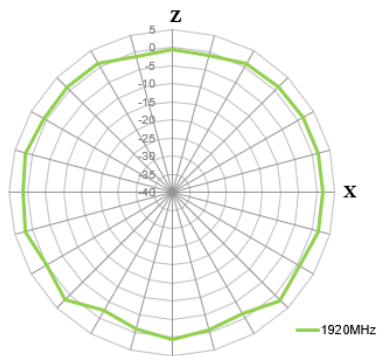
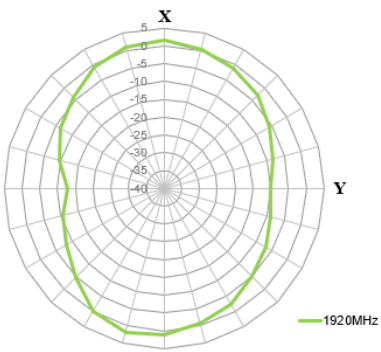

1990MHz

Azimuth = 0.0
Elevation = 0.0
Roll = -45.0

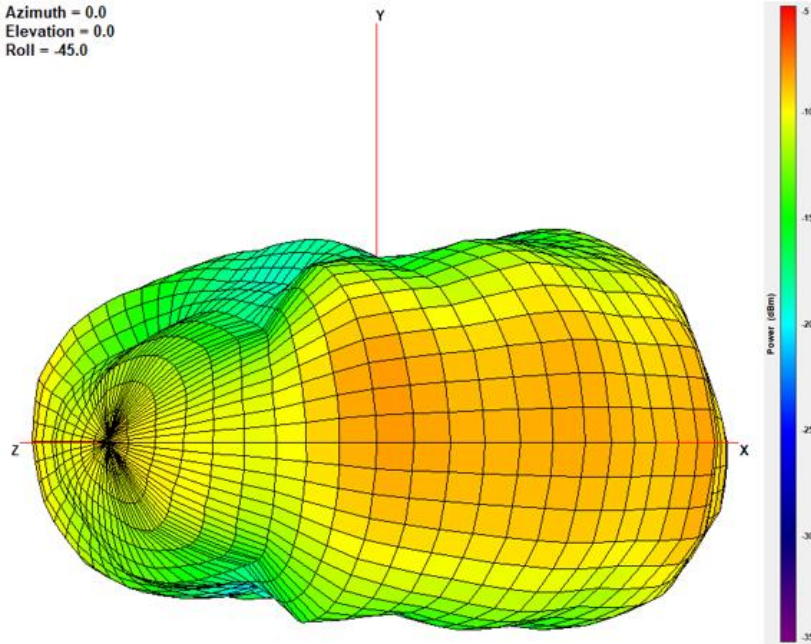

XY Plane

XZ Plane

YZ Plane

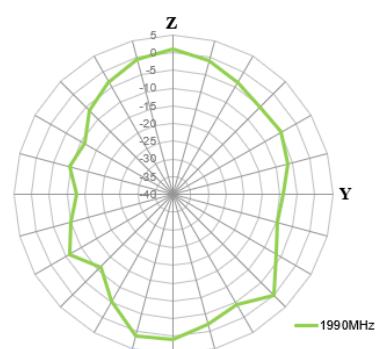
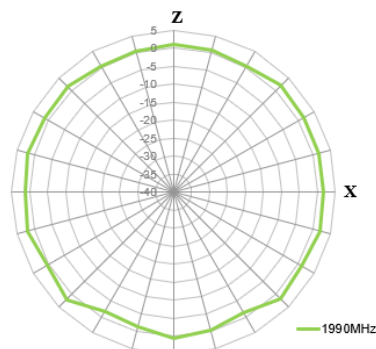
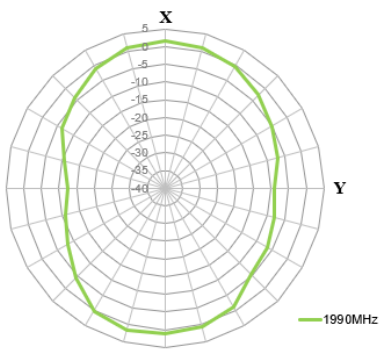

2595MHz

Azimuth = 0.0
Elevation = 0.0
Roll = -45.0

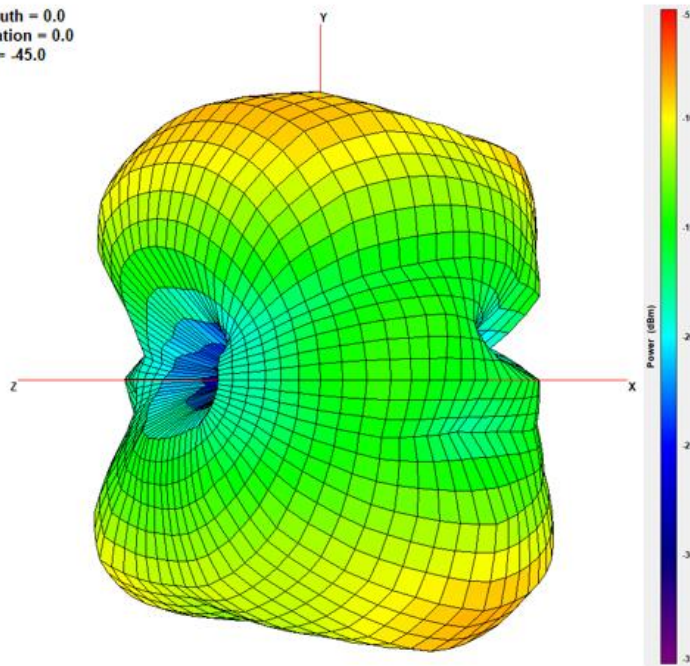

XY Plane

XZ Plane

YZ Plane

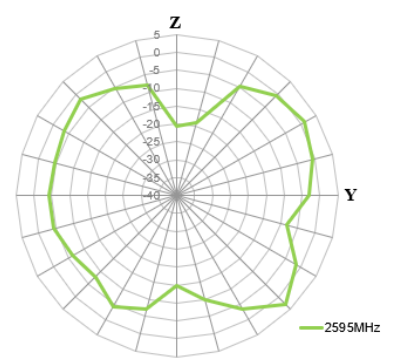
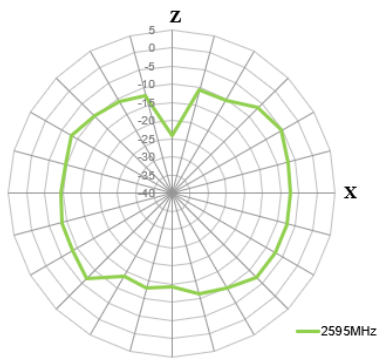
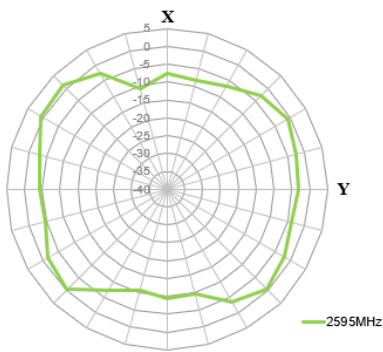

3550MHz

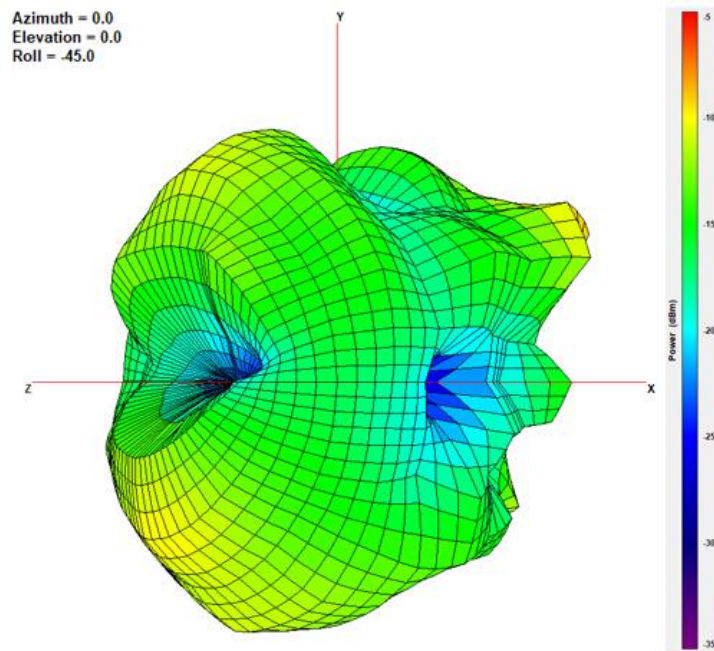

XY Plane

XZ Plane

YZ Plane

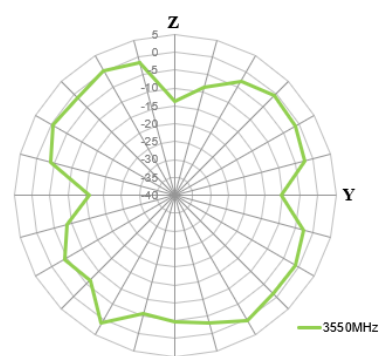
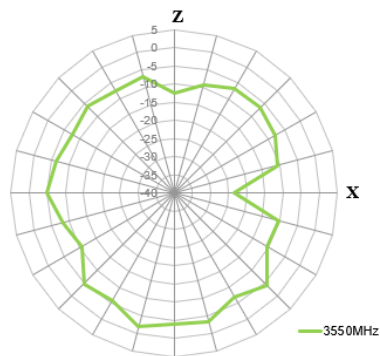
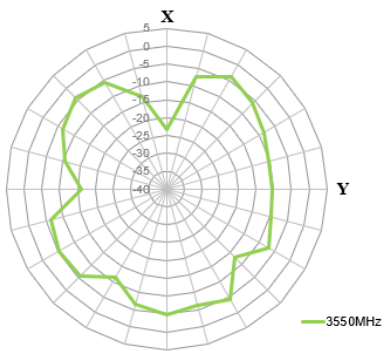

5530MHz

Azimuth = 0.0
Elevation = 0.0
Roll = -45.0

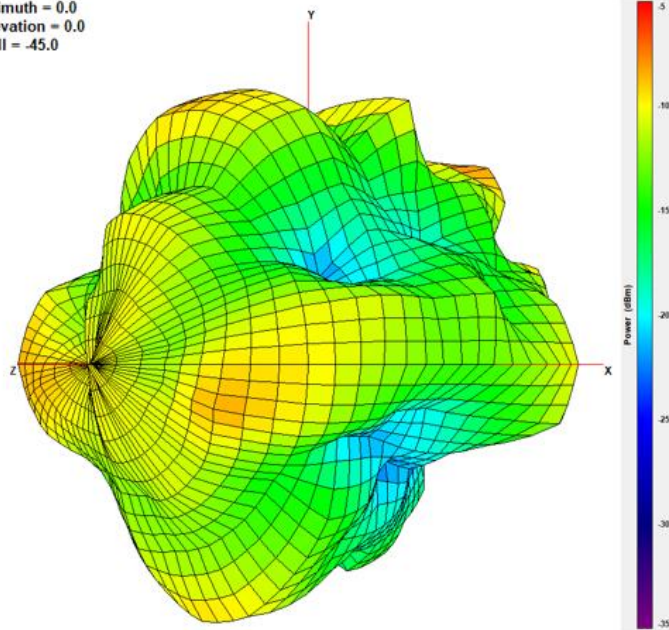

XY Plane

XZ Plane

YZ Plane

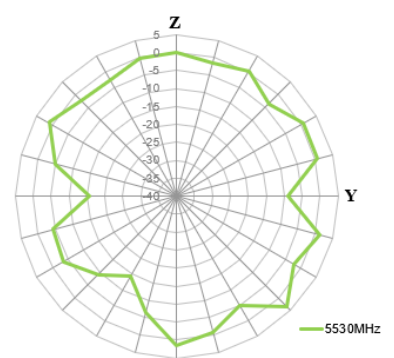
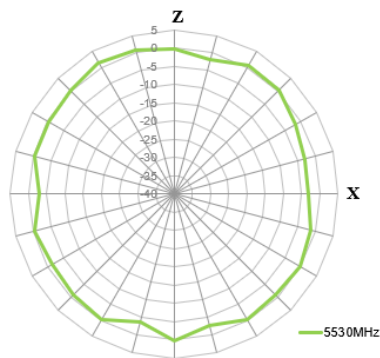
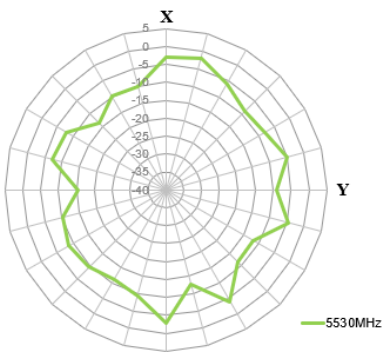

4.5 Test Setup – Centre_30X30cm_Ground plane

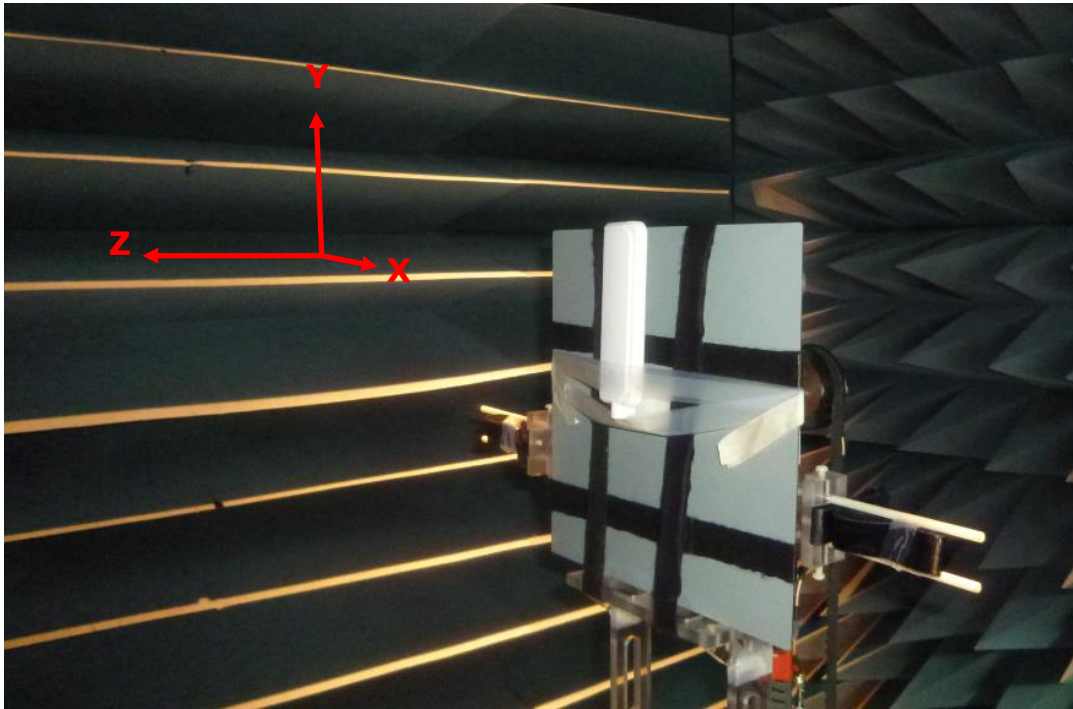

4.6 650MHz – Centre_30X30cm_Ground plane 2D & 3D Radiation Patterns

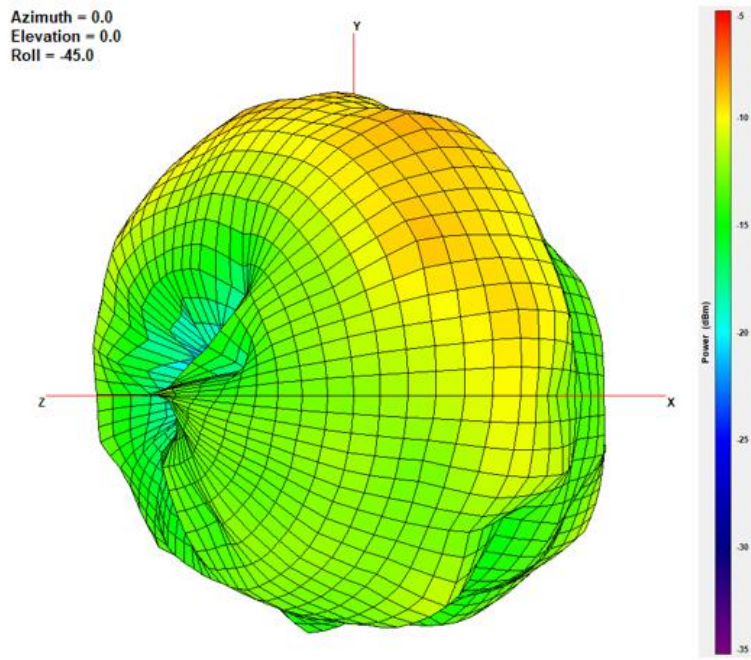

XY Plane XZ Plane YZ Plane

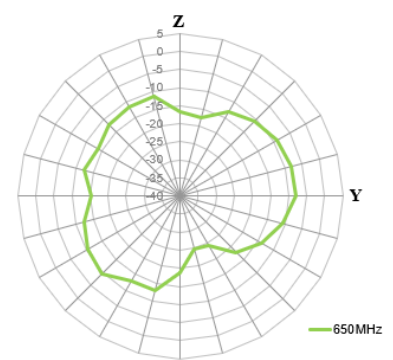
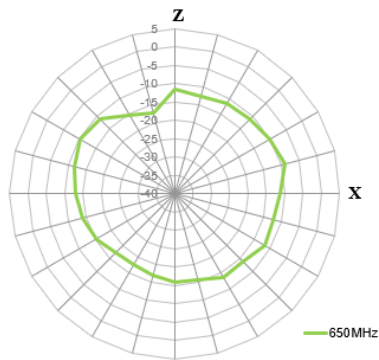
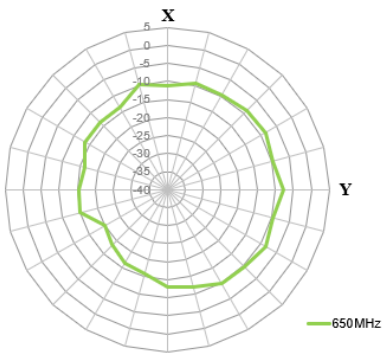

750MHz

Azimuth = 0.0
Elevation = 0.0
Roll = -45.0

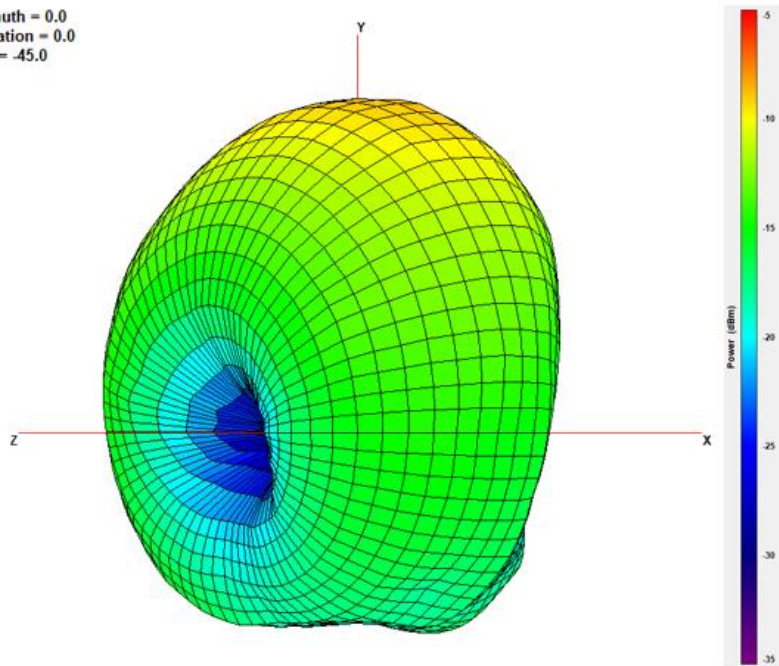

XY Plane

XZ Plane

YZ Plane

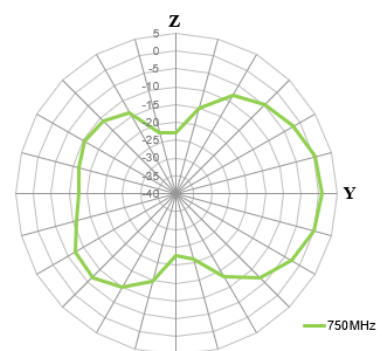
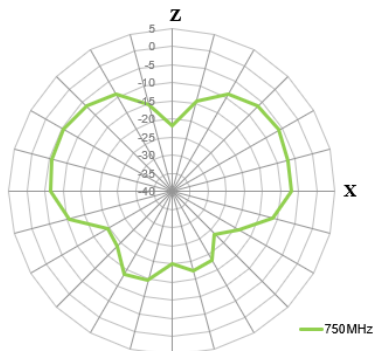
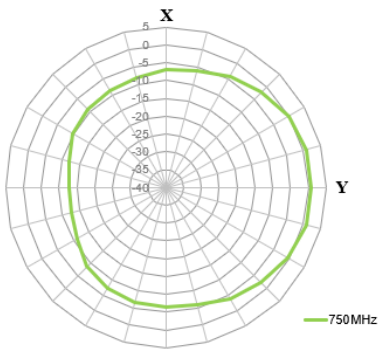

890MHz

Azimuth = 0.0
Elevation = 0.0
Roll = -45.0

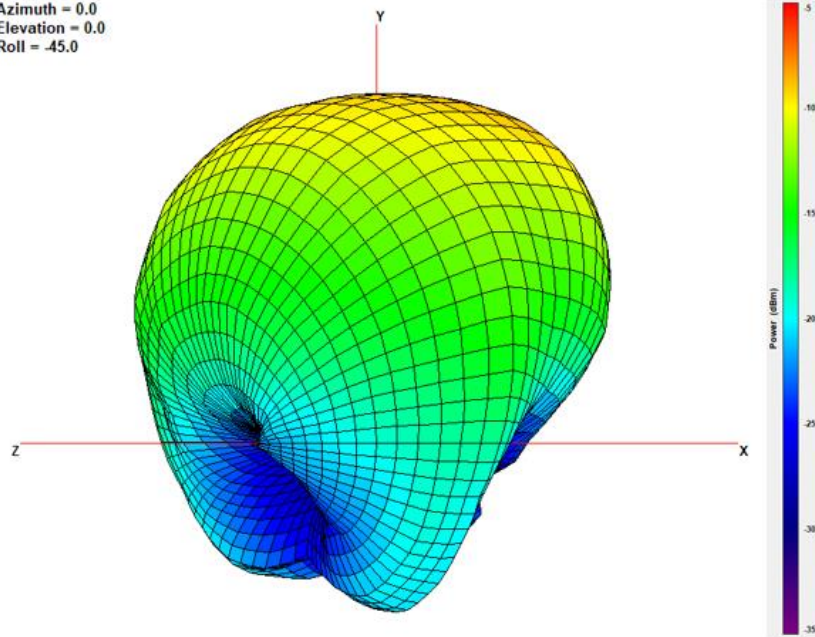

XY Plane

XZ Plane

YZ Plane

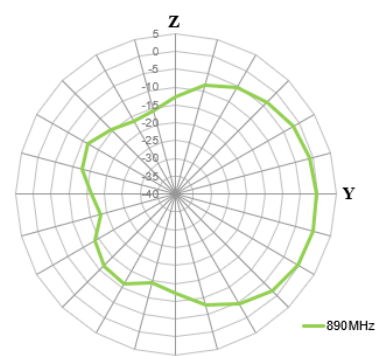
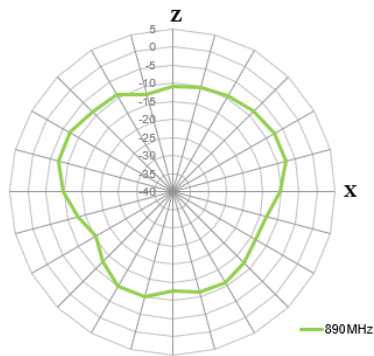
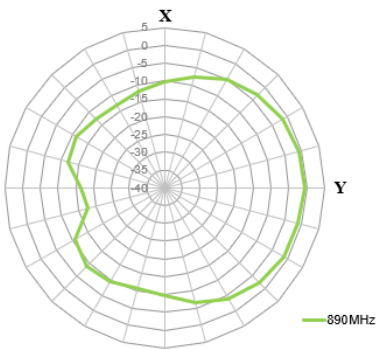

1470MHz

Azimuth = 0.0
Elevation = 0.0
Roll = -45.0

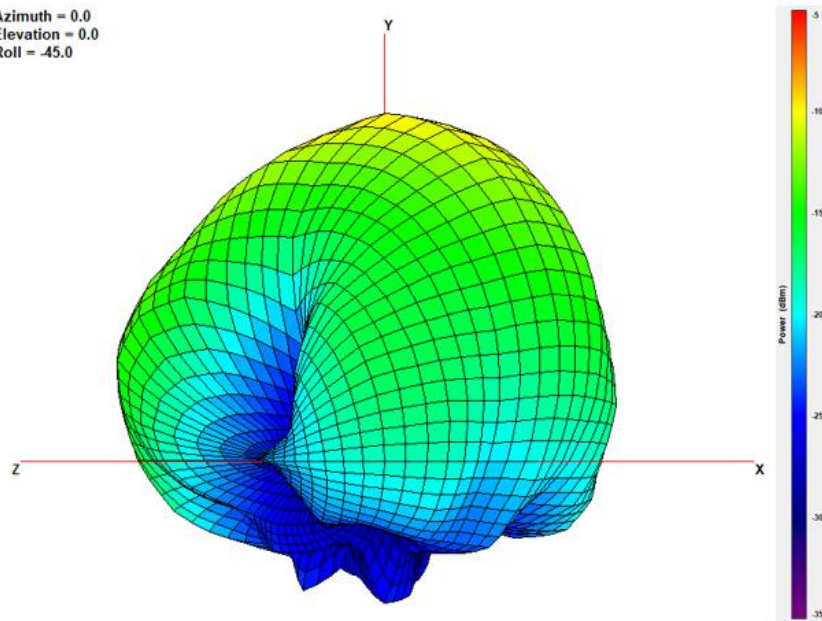

XY Plane

XZ Plane

YZ Plane

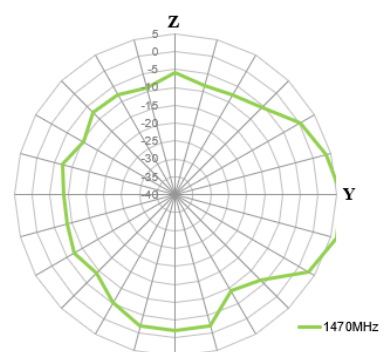
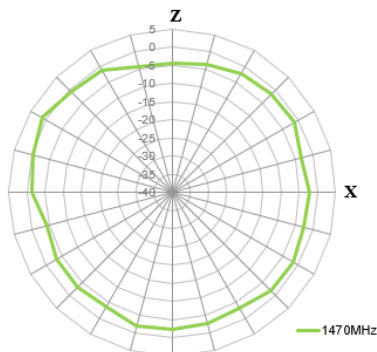
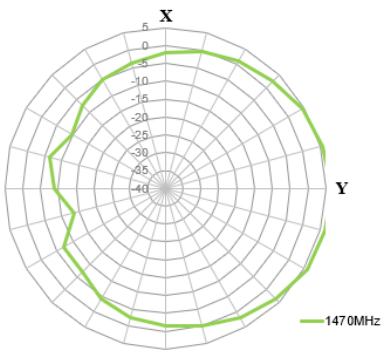

1805MHz

Azimuth = 0.0
Elevation = 0.0
Roll = -45.0

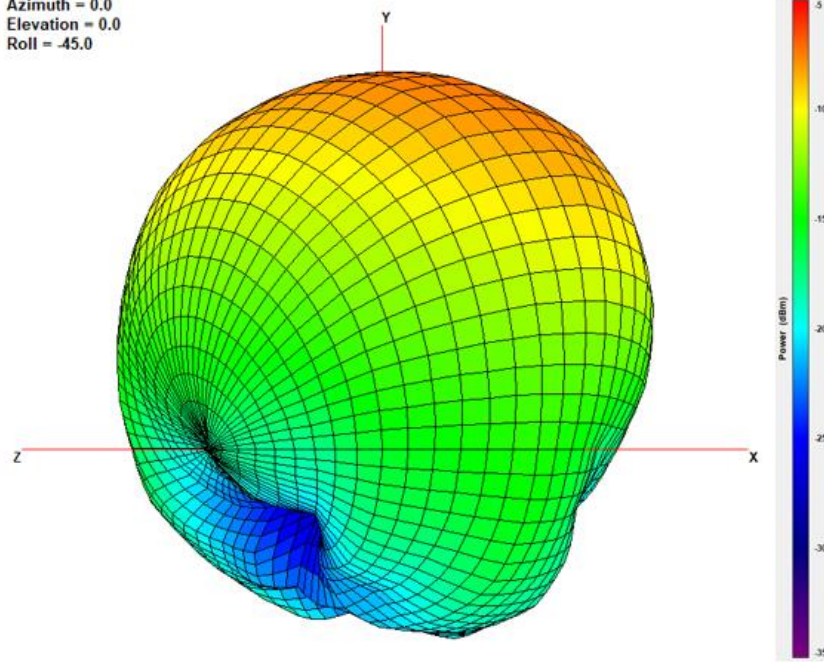

XY Plane

XZ Plane

YZ Plane

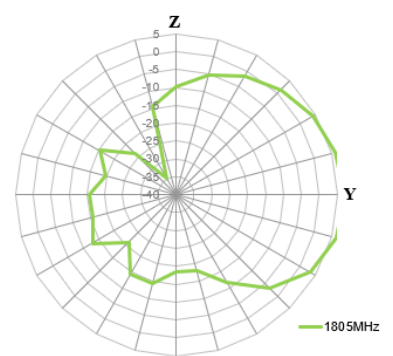
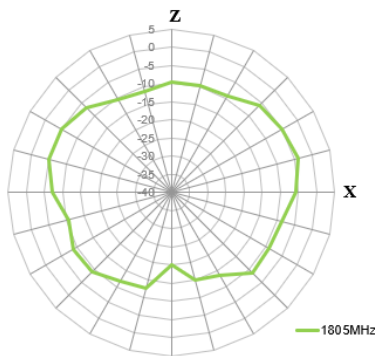
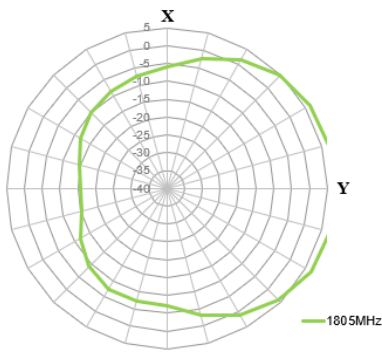

1920MHz

Azimuth = 0.0
Elevation = 0.0
Roll = -45.0

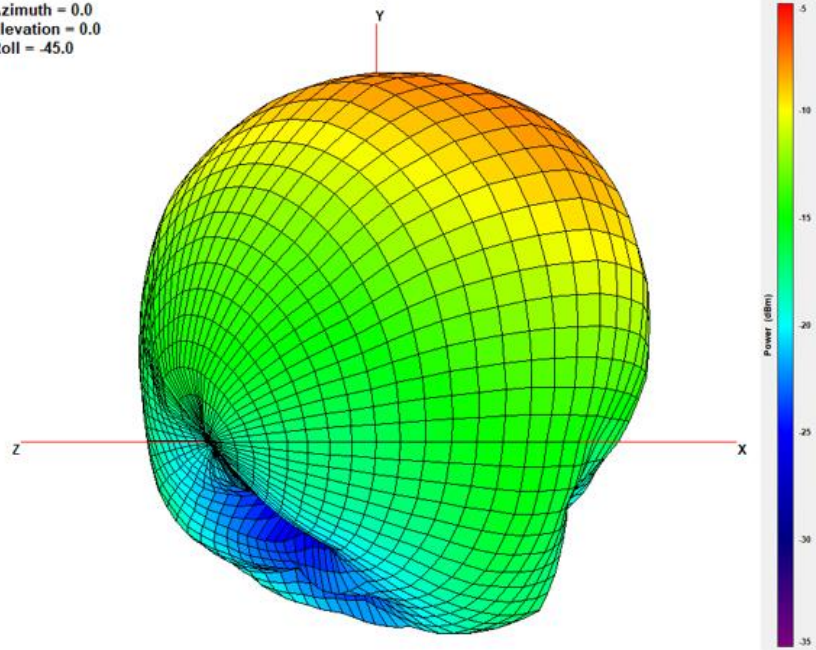

XY Plane

XZ Plane

YZ Plane

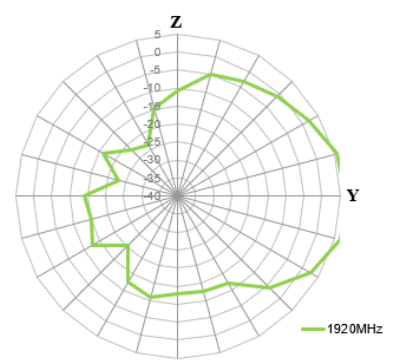
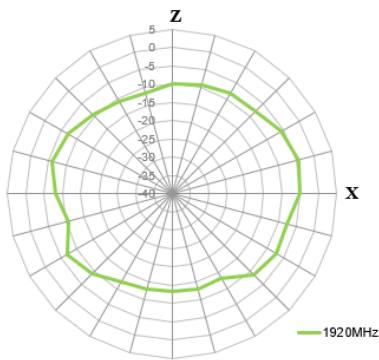
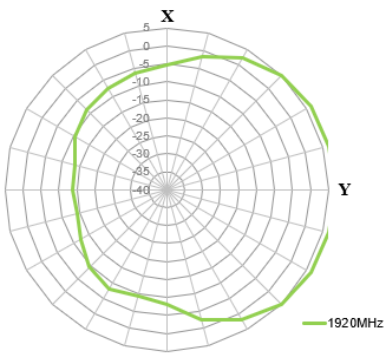

1990MHz

Azimuth = 0.0
Elevation = 0.0
Roll = -45.0

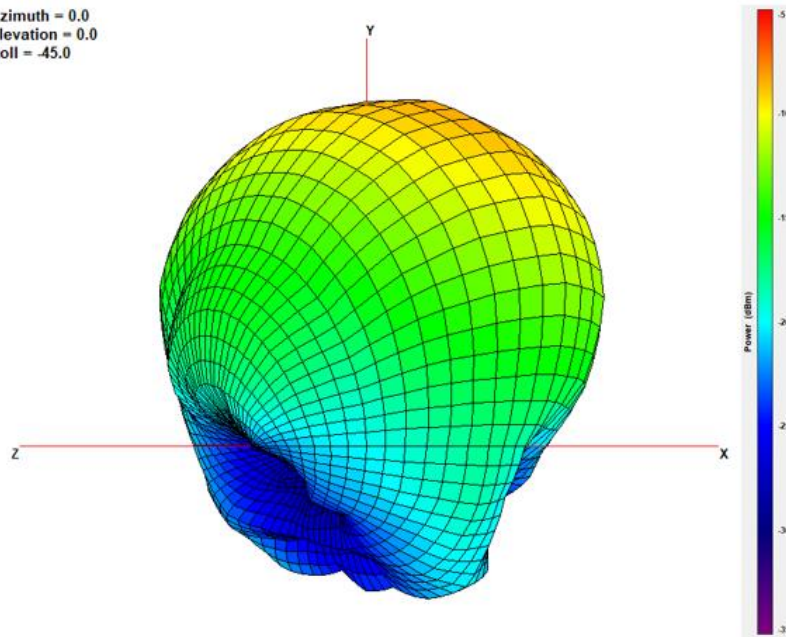

XY Plane

XZ Plane

YZ Plane

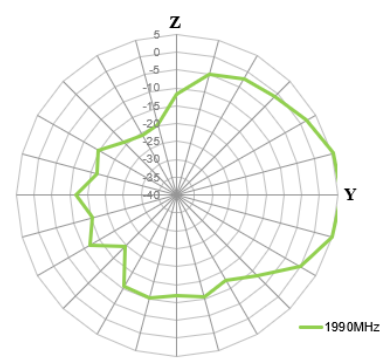
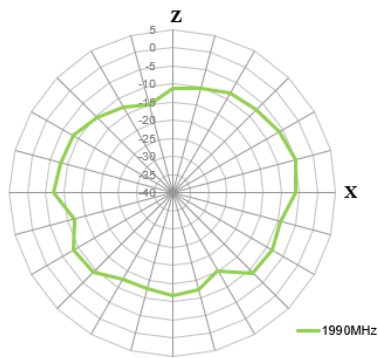
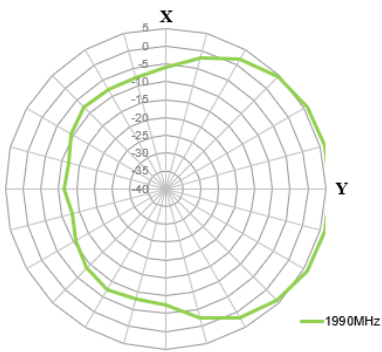

2595MHz

Azimuth = 0.0
Elevation = 0.0
Roll = -45.0

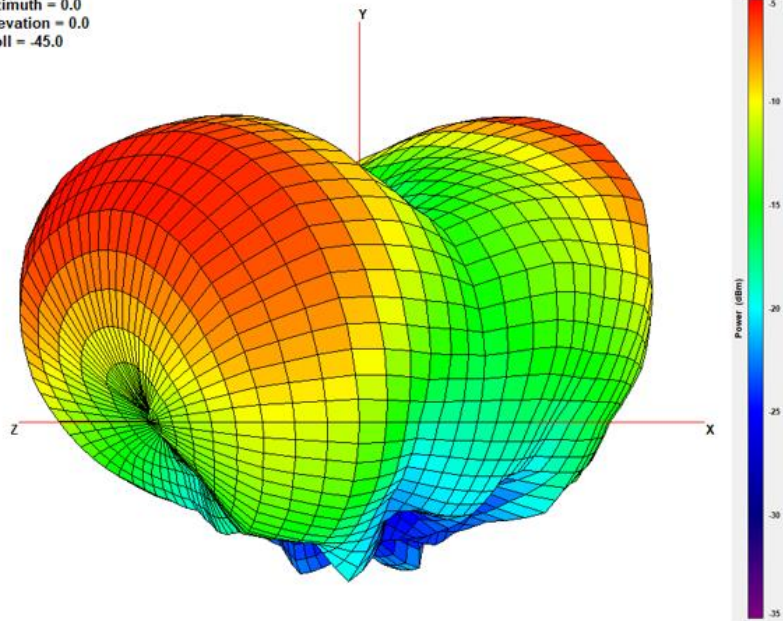

XY Plane

XZ Plane

YZ Plane

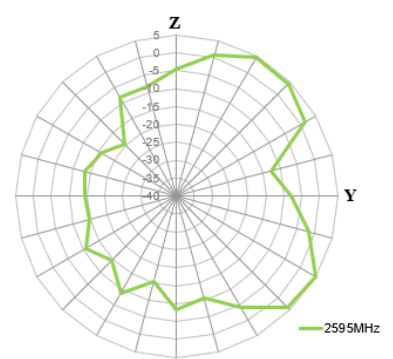
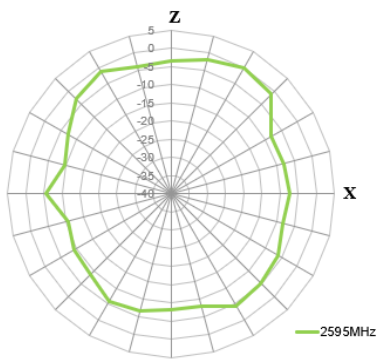
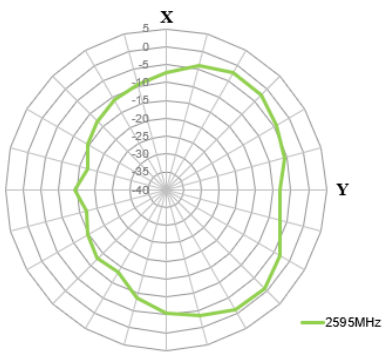

3550MHz

Azimuth = 0.0
Elevation = 0.0
Roll = -45.0

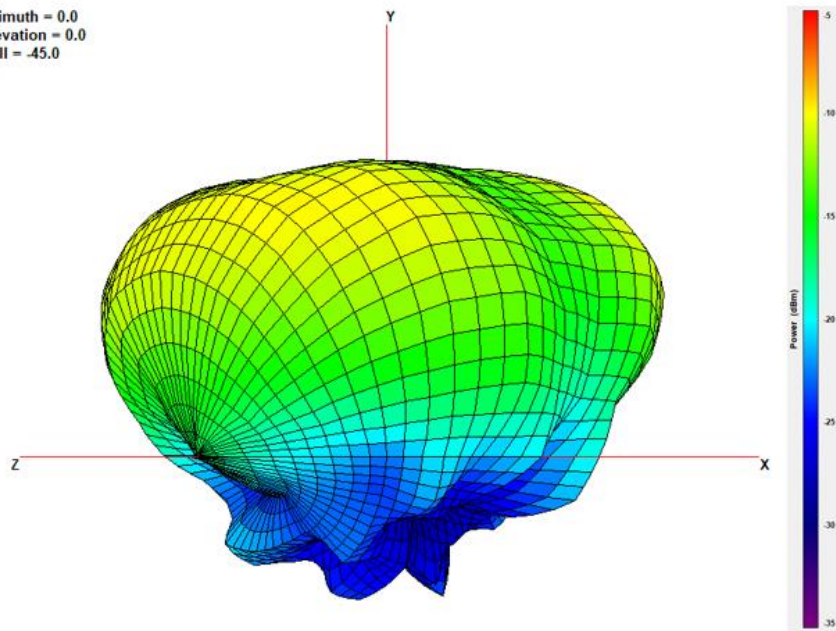

XY Plane

XZ Plane

YZ Plane

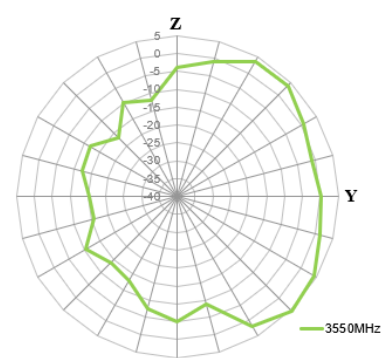
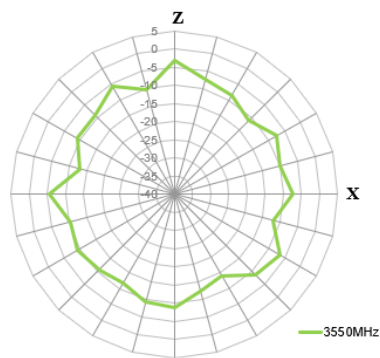
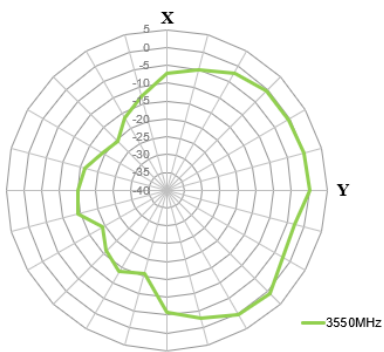

5530MHz

Azimuth = 0.0
Elevation = 0.0
Roll = -45.0

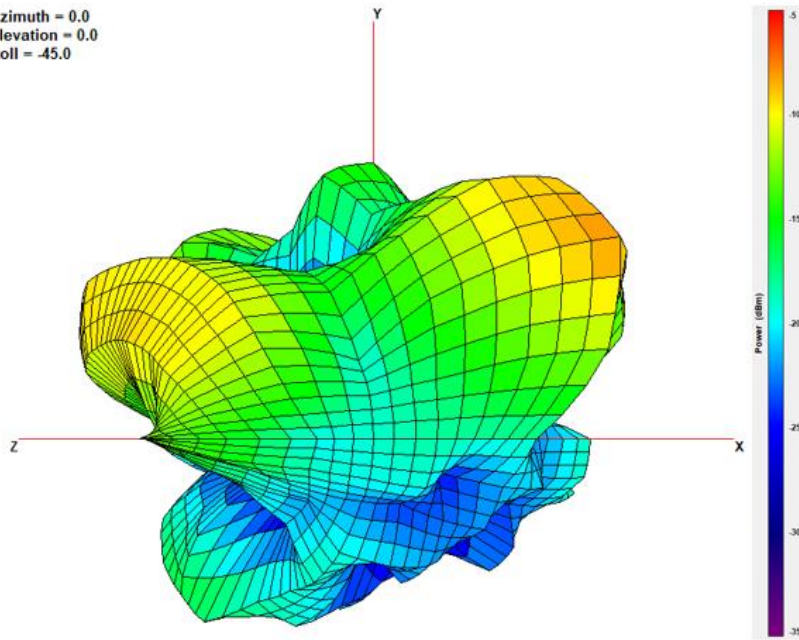

XY Plane

XZ Plane

YZ Plane

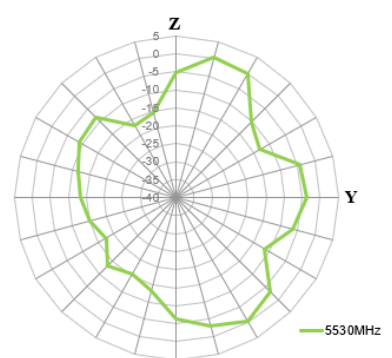
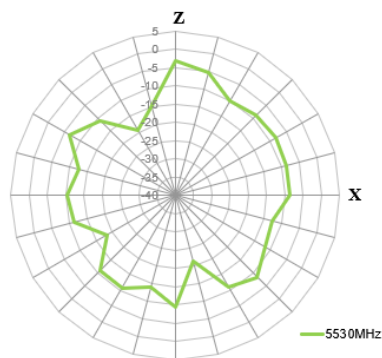
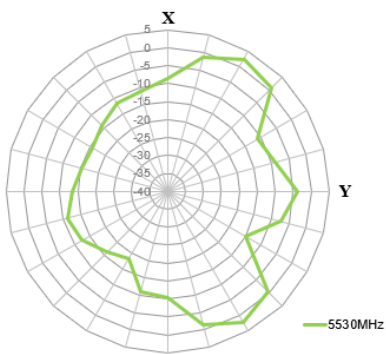

5. Mechanical Drawing (Units: mm)

Front View

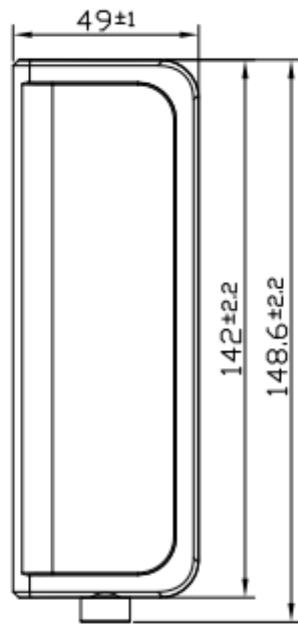

Side View

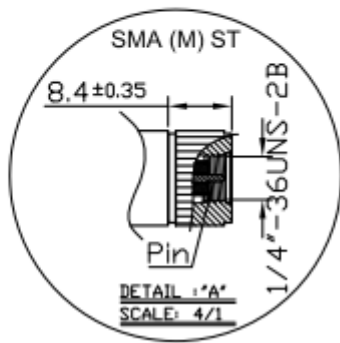
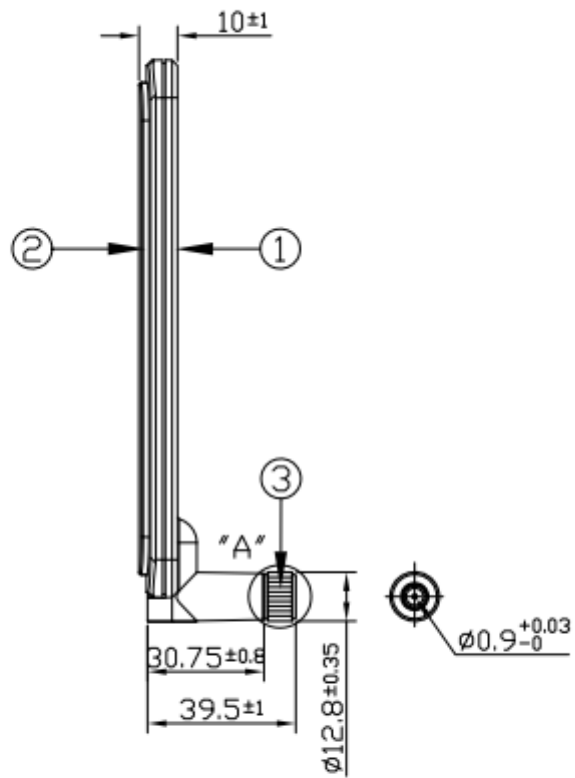

6. Packaging

1 pcs TG.30.8112 per PE Bag
 PE Bag Dimensions - 75*210mm
 Weight - 48g

50 PE Bags per Large PE Bag
 50 pcs TG.30.8112 per Large PE Bag
 Large PE Dimensions - 360*520mm
 Weight - 2.4kg

5 Large PE bags per carton
 250 pcs TG.30.8112 per carton
 Carton Dimensions - 430*380*280mm
 Weight - 12.4kg

Pallet Dimensions 1200mm*1000mm*1320mm
 12 Cartons per Pallet
 6 Cartons per layer
 2 Layers

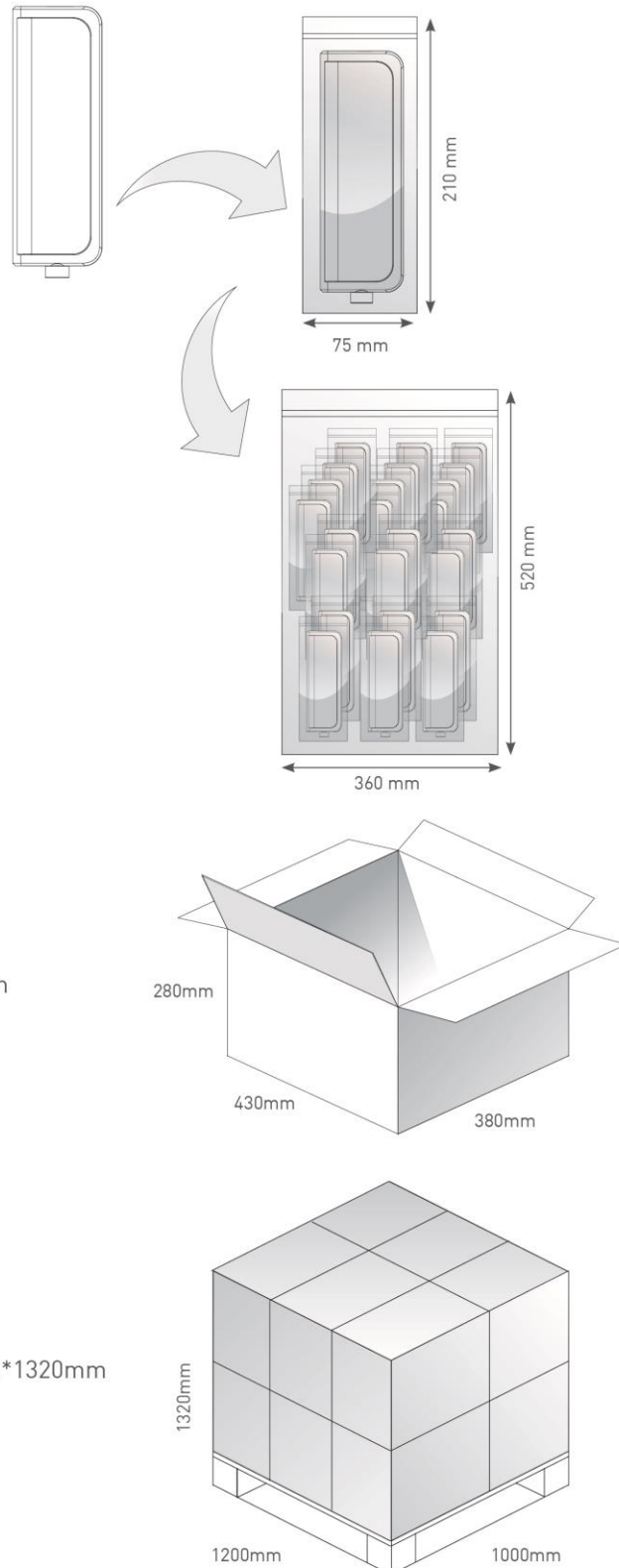

Changelog for the datasheet

SPE-12-8-120 - TG.30.8112

Revision: H (Current Version)

Date:	2022-05-05
Changes:	Full datasheet template update and show data 600-6000.
Changes Made by:	Gary West

Previous Revisions

Revision: G

Date:	2021-07-09
Changes:	Added IP Rating
Changes Made by:	Gary West

Revision: B

Date:	2012-09-27
Changes:	
Changes Made by:	Technical Writer

Revision: F

Date:	2018-11-30
Changes:	Removed IP rating
Changes Made by:	Jack Conroy

Revision: A (Original First Release)

Date:	2012-09-19
Notes:	
Author:	Technical Writer

Revision: E

Date:	2015-03-30
Changes:	Updated Spec with LTE table
Changes Made by:	Andy Mahoney

Revision: D

Date:	2017-01-13
Changes:	
Changes Made by:	Technical Writer

Revision: C

Date:	2012-10-04
Changes:	
Changes Made by:	Technical Writer



TAOGLAS®

www.taoglas.com

