

# EVC170

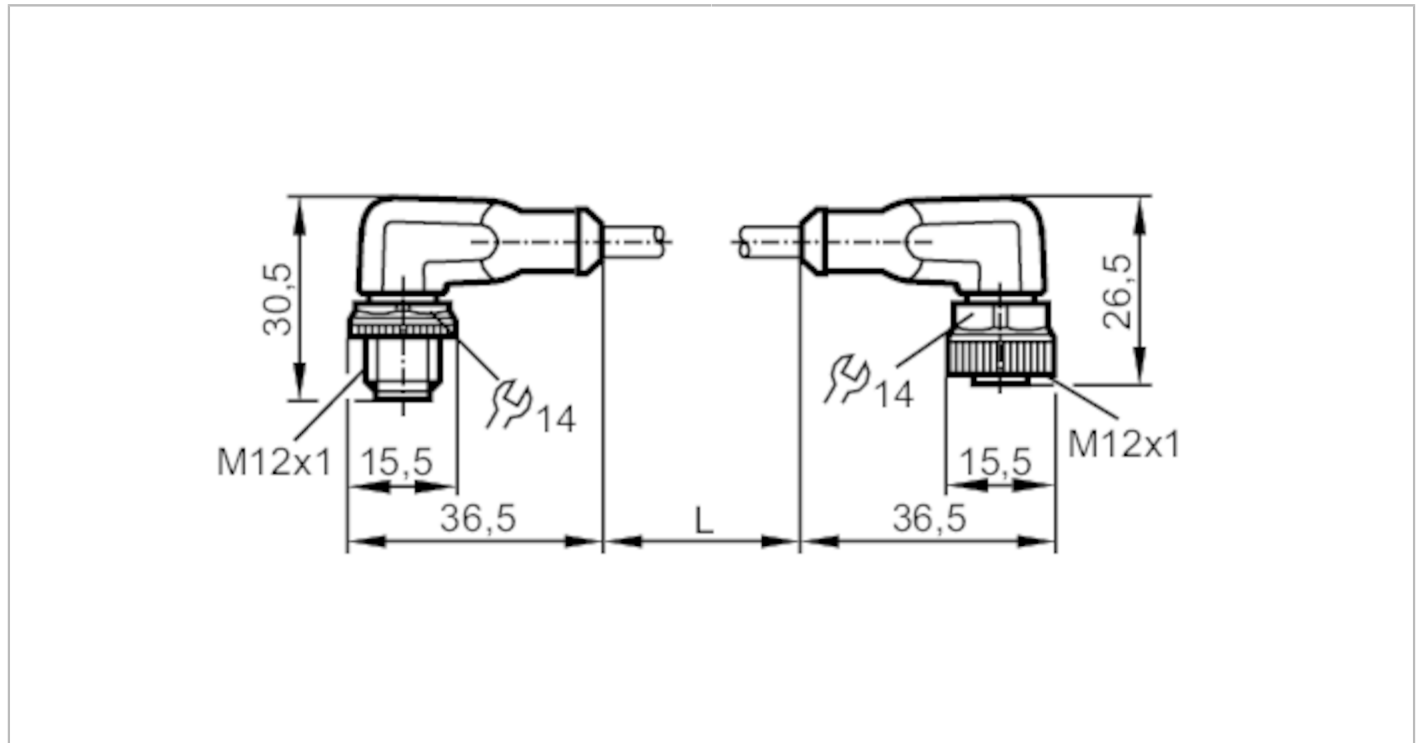

## Connection cable

VDOAH040MSS0004H04STAH040MSS



Application	
Special feature	Free from silicone; Halogen-free; Gold-plated contacts; Drag chain suitability
Free from silicone	yes
Electrical data	
Operating voltage [V]	< 250 AC / < 300 DC
Protection class	II
Max. current load total [A]	4
Operating conditions	
Ambient temperature [°C]	-25...90
Note on ambient temperature	cULus: ...75
Ambient temperature (moving) [°C]	-25...90
Note on ambient temperature (moving)	cULus: ...75
Protection	IP 65; IP 67; IP 68; IP 69K

# EVC170



## Connection cable

VDOAH040MSS0004H04STAH040MSS

Mechanical data		
Weight [g]	144.8	
Dimensions [mm]	30.5 x 15.5 x 36.5	
Materials	housing: TPU orange; Sealing: FKM	
Material nut	brass, nickel-plated / brass, nickel-plated	
Drag chain suitability	yes	
Drag chain suitability	bending radius for flexible use	min. 10 x cable diameter
	travel speed	max. 3.3 m/s for a horizontal travel length of 5 m and max. acceleration of 5 m/s <sup>2</sup>
	bending cycles	> 5 Mio.
	torsional strain	± 180 °/m

Remarks	
Notes	Please see the technical note under "Downloads"
Pack quantity	1 pcs.

### Electrical connection - plug

Connector: 1 x M12, angled; Locking: brass, nickel-plated; Contacts: gold-plated; Tightening torque: 0.6...1.5 Nm



### Electrical connection

Cable: 4 m, PUR, Halogen-free, black, Ø 4.3 mm; 4 x 0.34 mm<sup>2</sup> (42 x Ø 0.1 mm )

### Connection

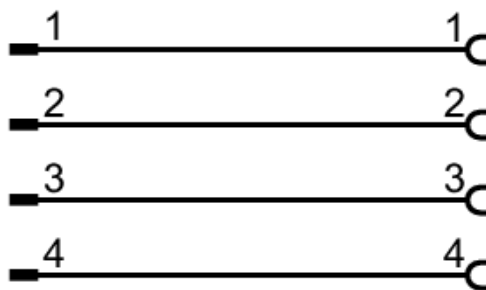

### Electrical connection - socket

Connector: 1 x M12, angled; Locking: brass, nickel-plated; Contacts: gold-plated; Tightening torque: 0.6...1.5 Nm

# EVC170



## Connection cable

VDOAH040MSS0004H04STAH040MSS

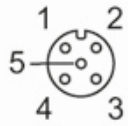

### Diagrams and graphs

characteristic line for derating

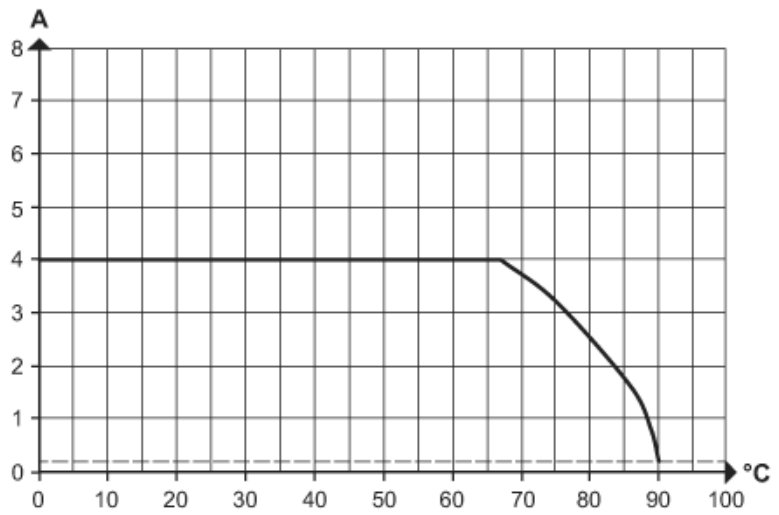

Derating  $I_{max} * 0.8$  (DIN EN 60512-5-2)

X Ambient temperature [°C]

Y Current [A]