

EVT235

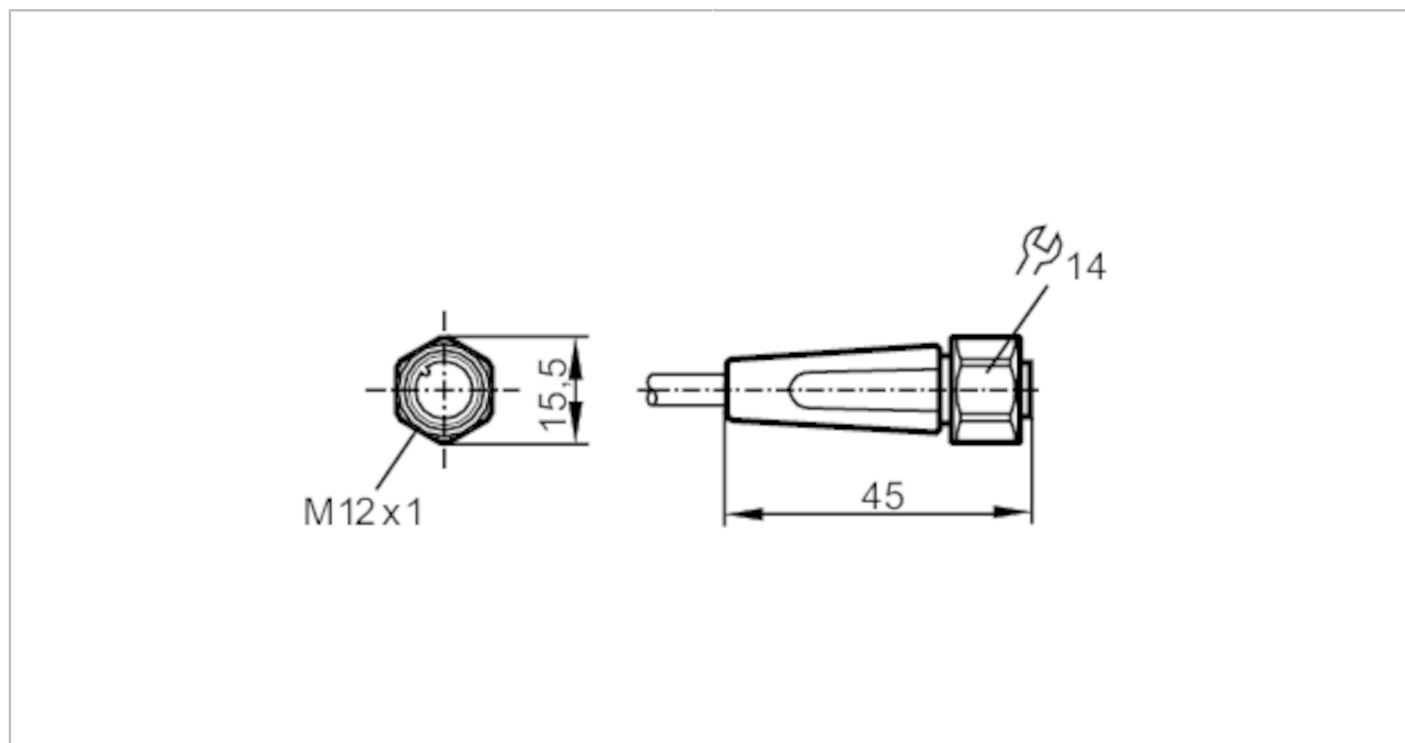

Connecting cable with socket

ADOGH050VAS0002E05



Application	
Special feature	Free from silicone; Gold-plated contacts; Drag chain suitability
Application	hygienic and wet areas in the food industry
Free from silicone	yes
Electrical data	
Operating voltage [V]	< 60 AC/DC
Protection class	II
Max. current load total [A]	4; (cULus: 3)
Operating conditions	
Ambient temperature [°C]	-25...100
Note on ambient temperature	cULus: ...50
Ambient temperature (moving) [°C]	5...100
Note on ambient temperature (moving)	cULus: ...50
Protection	IP 65; IP 67; IP 68; IP 69K

EVT235



Connecting cable with socket

ADOGH050VAS0002E05

Mechanical data		
Weight [g]	105.3	
Dimensions [mm]	15.5 x 15.5 x 45	
Materials	housing: PVC orange; Sealing: EPDM	
Material nut	stainless steel (1.4404 / 316L)	
Drag chain suitability	yes	
Drag chain suitability	bending radius for flexible use	min. 10 x cable diameter
	travel speed	max. 3.3 m/s for a horizontal travel length of 5 m and max. acceleration of 5 m/s ²
	bending cycles	> 1 Mio.
	torsional strain	± 180 °/m

Remarks	
Pack quantity	1 pcs.

Electrical connection	
Cable: 2 m, PVC, orange, Ø 5.1 mm; 5 x 0.34 mm ² (42 x Ø 0.1 mm)	

Electrical connection - socket	
Connector: 1 x M12, straight; Locking: stainless steel (1.4404 / 316L); Contacts: gold-plated; Tightening torque: 0.6...1.5 Nm	



EVT235



Connecting cable with socket

ADOGH050VAS0002E05

Connection

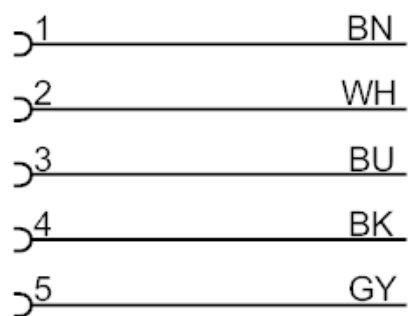

Core colours :

BK =	black
BN =	brown
BU =	blue
GY =	grey
WH =	white