

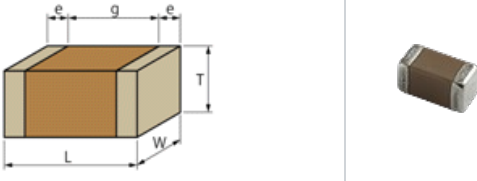

< List of part numbers with package codes >
GRM31A7U3A331JW31D , GRM31A7U3A331JW31J

Shape



L size	3.2 ±0.2mm
W size	1.6 ±0.2mm
T size	1.0 +0/-0.3mm
External terminal width e	0.3mm min.
Distance between external terminals g	1.5mm min.
Size code in inch(mm)	1206 (3216M)

References

Packaging	Specifications	Minimum quantity
D	φ180mm Paper taping	4000
J	φ330mm Paper taping	10000
Mass (typ.)		
1 piece		27.0mg

Specifications

Capacitance	330pF ±5%
Rated voltage	1000Vdc
Temperature characteristics (complied standard)	U2J(EIA)
Temperature coefficient	-750±120ppm/°C
Temperature range of temperature characteristics	25 to 125°C
Operating temperature range	-55 to 125°C

Attention

- 1.This datasheet is downloaded from the website of Murata Manufacturing Co., Ltd. Therefore, it's specifications are subject to change or our products in it may be discontinued without advance notice. Please check with our sales representatives or product engineers before ordering.
- 2.This datasheet has only typical specifications because there is no space for detailed specifications. Therefore, please review our product specifications or consult the approval sheet for product specifications before ordering.

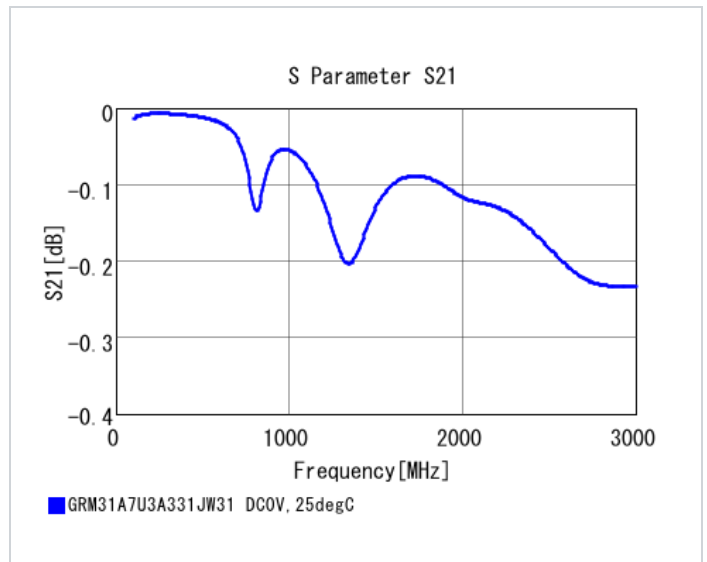
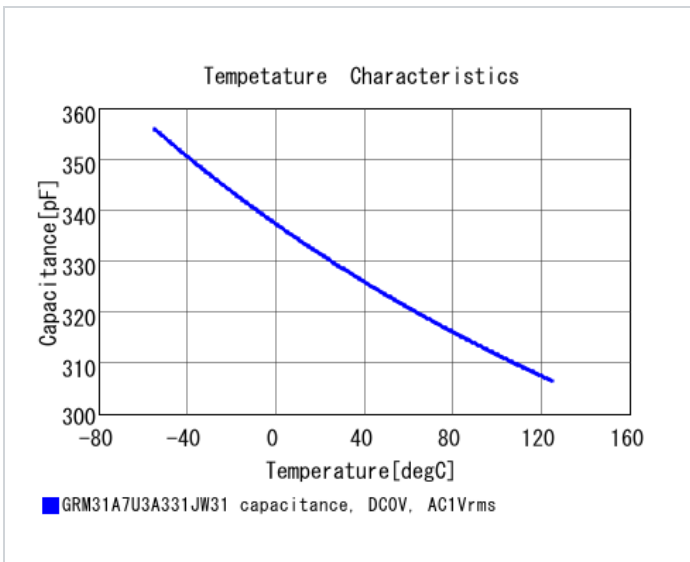
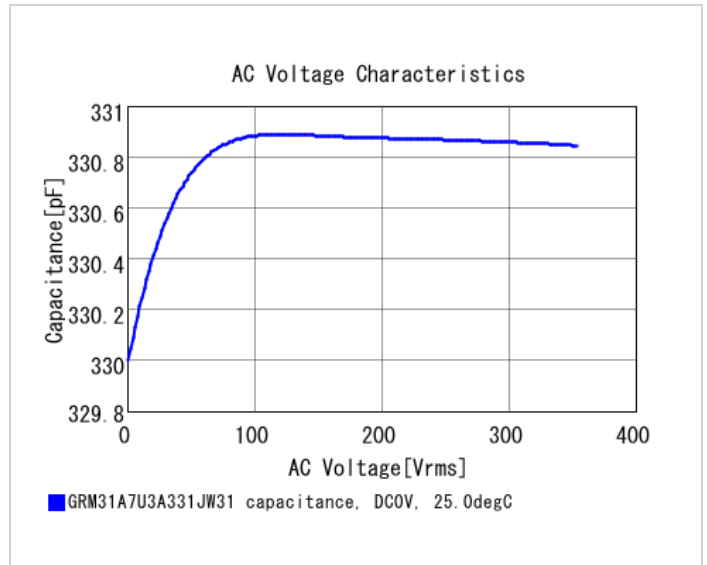
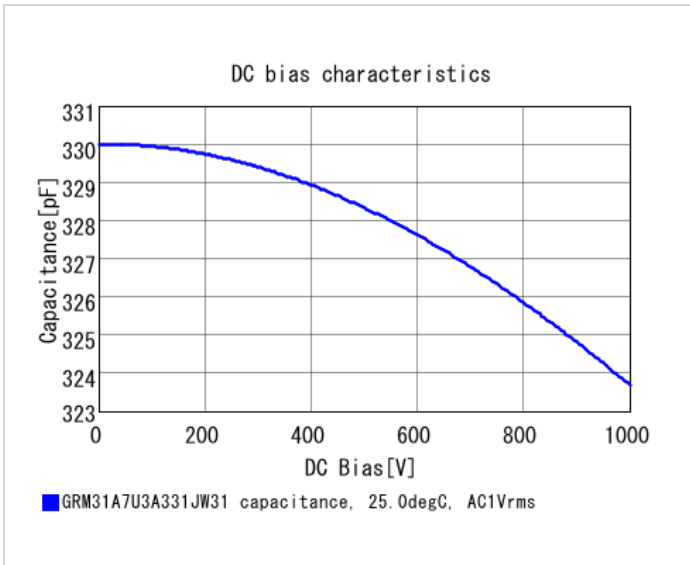
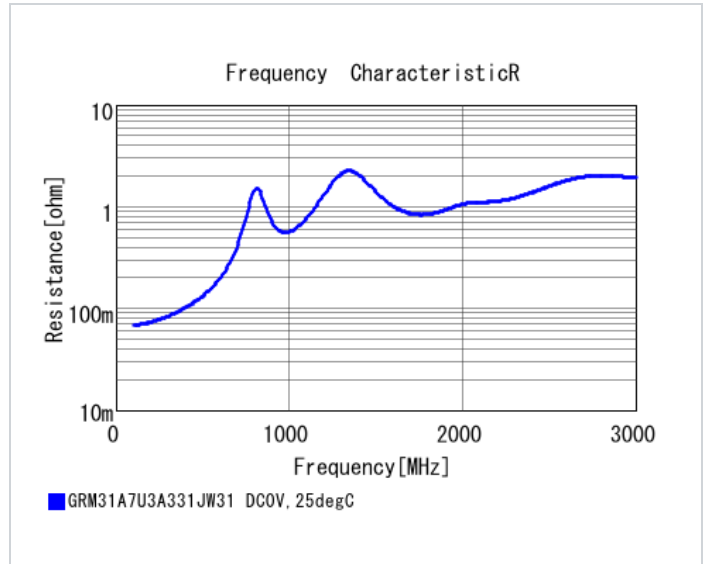
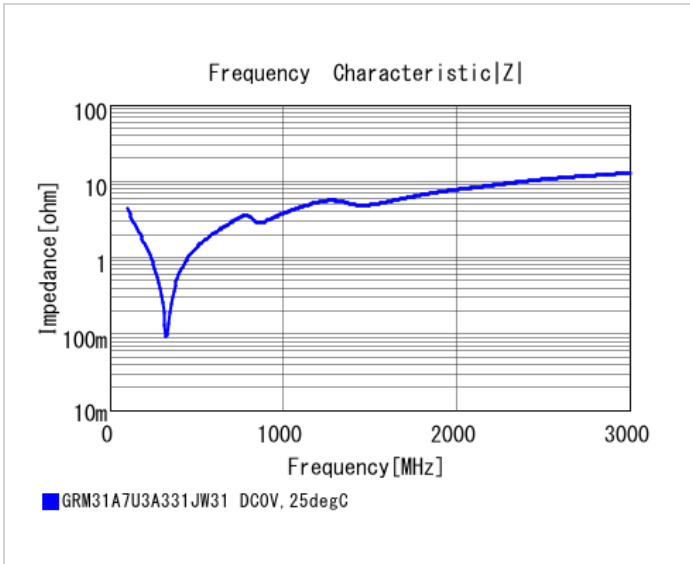

⚠ Attention

1.This datasheet is downloaded from the website of Murata Manufacturing Co., Ltd. Therefore, it's specifications are subject to change or our products in it may be discontinued without advance notice. Please check with our sales representatives or product engineers before ordering.

2.This datasheet has only typical specifications because there is no space for detailed specifications.

Therefore, please review our product specifications or consult the approval sheet for product specifications before ordering.