



Electrical • Data Com • HVAC • Plumbing • Telecom • Utility
Heavy Infrastructure • Steel and Concrete Construction

www.kleintools.com

WHAT'S NEW for 2019



Hybrid Pliers with Crimper
pg. 11



Stripper/Crimper/Cutter
pg. 25



Refrigeration Wrench Hex Adapter
pg. 84, 222



Multi-Nut Driver
pg. 67



Large Cable Strippers
pg. 24

Fish & Glow Rod Kit and Accessories
pg. 107-108



XXL Mobile Phone Holder
pg. 129, 144



24" Bubble Level with Adjustable Vial
pg. 100



Padded Leather, Quick Release Belts
pg. 149



Magnetic Wristband
pg. 129



Bolt Bag with Drain Holes
pg. 136



Lineman's Duffel Bag
pg. 159



9 qt. Cooler
pg. 127

Extended Reach Compression Crimper
pg. 174



Coax Pocket Continuity Tester
pg. 183



TRADESMAN PRO™ Tool Master Backpack
pg. 151



Compact Pass-Thru™ Crimper
pg. 176



VDV Installation Kits
pg. 180, 182



Clamp Meters
pg. 194



K-Type Thermocouples
pg. 199

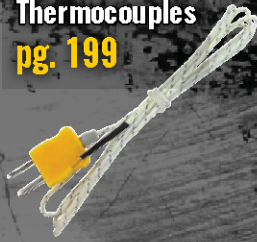

Fork Meter
pg. 196



Flexible Clamp Meter
pg. 196



Electronic Voltage Tester
pg. 201



USB Meters
pg. 204



20:1 Dual Laser Infrared Thermometer
pg. 207



Folding Jab Saw
pg. 235



Clamping Worklight
pg. 215



Dual IR/Probe Thermometer
pg. 206



Rechargeable Auto-Off Headlamp
pg. 214



Assisted-Open Pocket Knives
pg. 237



Vinyl Aerial Apron
pg. 254



Hybrid Plier Multi-Tool
pg. 241



Wire Pulling Grips
pg. 275-276



Battery-Operated Tools with 4 AMP Batteries
pg. 282-284



Vinyl Load Rated Bucket
pg. 250



Aviation Snips with Wire Cutters
pg. 217



Sheet Metal Tools
pg. 218-219



Klein Pliers	Pages 5-22	Test & Measurement Tools	Pages 193-211
Strippers, Cutters & Crimpers	Pages 23-29	Illumination	Pages 212-215
Cable & Bolt Cutters	Pages 30-36	Sheet Metal Tools/HVAC	Pages 216-223
Insulated Tools	Pages 37-47	Holemaking Products & Accessories	Pages 224-231
Screwdrivers, Nut Drivers & Accessories	Pages 48-73	Saws & Blades	Pages 232-235
Wrenches	Pages 74-88	Knives & Cutting Tools	Pages 236-248
Hex-Key Wrenches	Pages 89-96	Lineman Buckets & Accessories	Pages 249-254
Levels & Measuring Tools	Pages 97-102	Block & Tackle	Pages 255-259
Wire Pulling and Conduit Tools	Pages 103-115	Wire Pulling Grips	Pages 260-280
Personal Protective Equipment & Safety Products	Pages 116-125	Battery-Operated Tools	Pages 281-284
Jobsite Accessories	Pages 126-129	Hammers, Chisels & Punches	Pages 285-290
Tool Pouches, Carriers, Belts & Suspenders	Pages 130-149	Steel & Concrete Construction/Work@Height Tools	Pages 291-296
Tool Bags & Storage	Pages 150-166	Warnings & Warranty	Pages 297-298
Tool Kits	Pages 167-171	Alphabetical & Numeric Indexes	Pages 299-320
Voice/Data/Video Tools, Test Tools, Kits & Connectors	Pages 172-192		

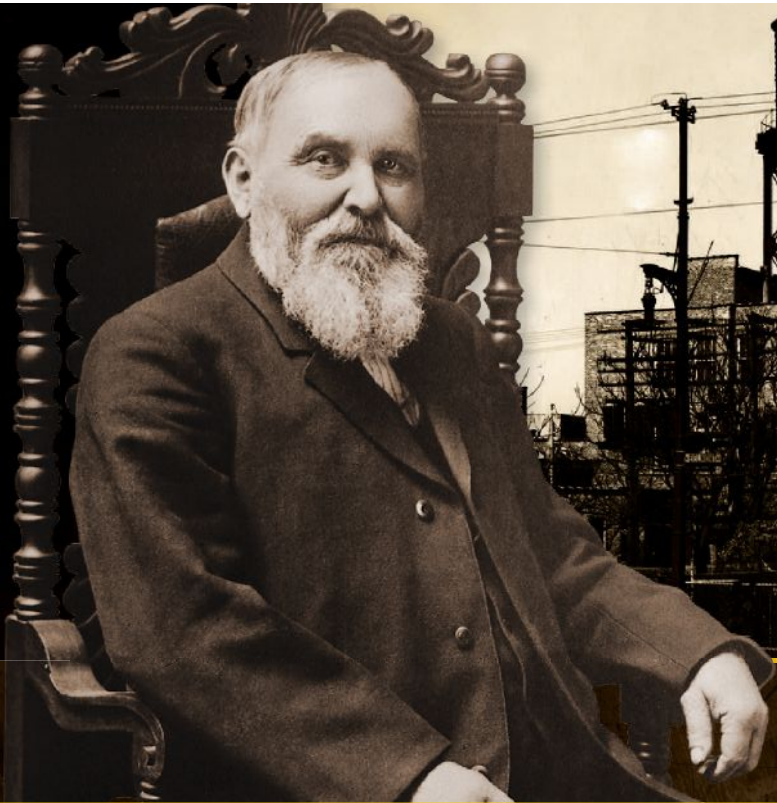

COMPANY HISTORY



Klein Tools was founded in 1857 by an industrious German immigrant, Mathias Klein, who began in the hand tool business when a broken side-cutting pliers was brought to his forge shop by a telegraph

lineman. Mathias repaired the pliers by forging and finishing a new half for the tool and riveting it to the old half. Soon the lineman returned because the other original half of the pliers had broken and needed replacement. Mathias forged and finished the second half of the pliers and riveted it to the other replacement half – creating the first complete Klein pliers.

To this day, Klein Tools is proudly owned and managed by the Klein family. Over 160 years of hard work and dedication has earned Klein the reputation of supplying only the finest quality products for users of professional hand tools, Test and Measurement and occupational protective equipment.

Klein Tools continues to expand domestically and internationally to provide quality products to professionals all over the world.

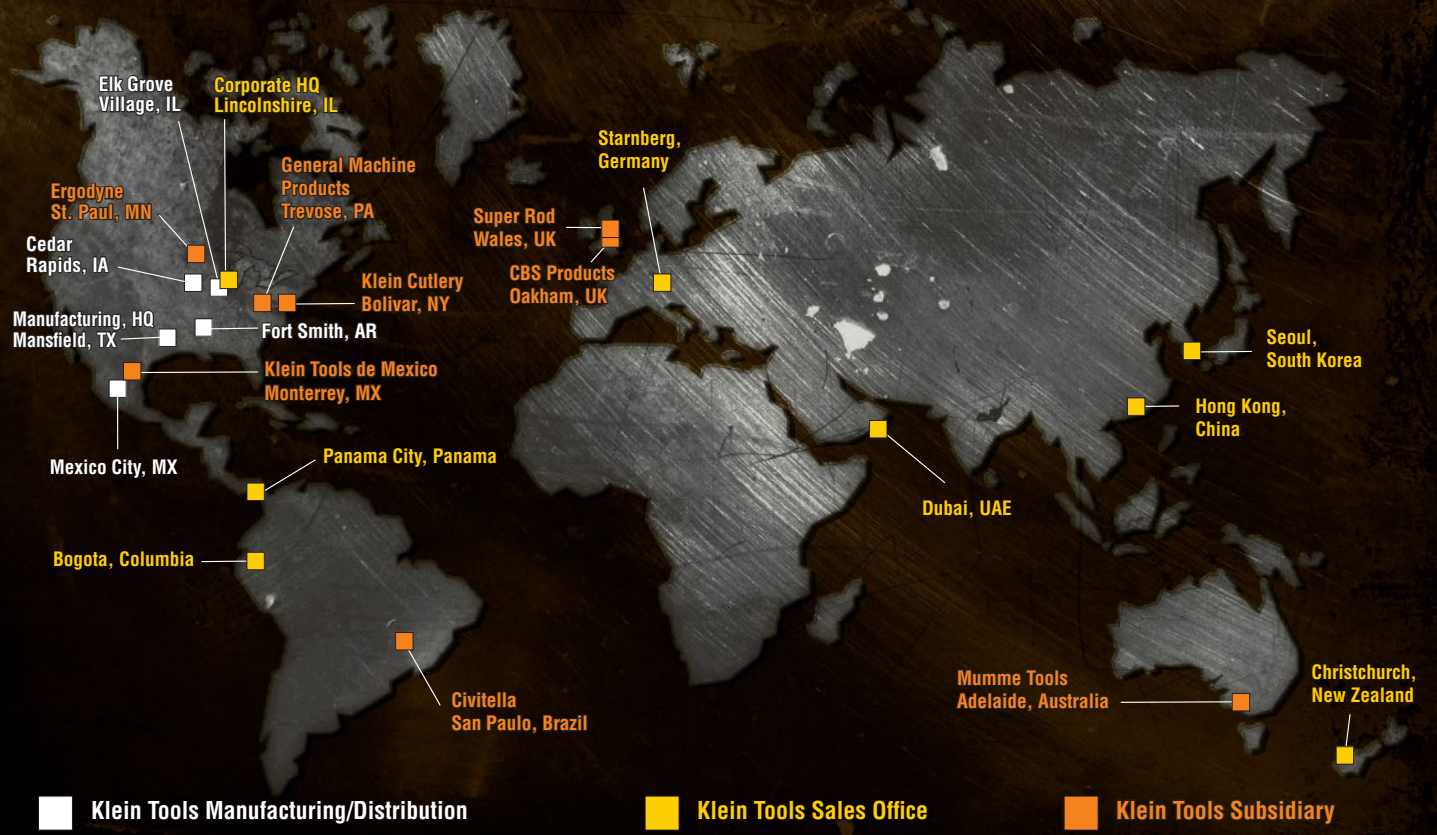



COMMITTED TO AMERICAN MANUFACTURING

FOR OVER 160 YEARS

Klein Tools has remained dedicated to professional tradesmen worldwide, with a commitment to manufacturing the world's finest hand tools right here in America.

These days, it can be hard to find companies that make products you can count on. But that's exactly what you'll get from Klein Tools. We don't just make great products, we make great products that stand up to the demands of the professionals who use them everyday. Because our standards are as high as yours, we demand that every one of our hand tools delivers all the performance, durability and precision that you need to get the job done right. And by using only the highest quality materials, superior workmanship, and keeping our manufacturing as close to home as we can, we're able to uphold those rigorous standards.

Klein isn't just the name of our company, it's also our family name, so we have to be proud of everything we make. And since we're an American company that's been family-owned and family-run, since 1857, you know you can count on us to be here tomorrow.

Just pick up a Klein tool and you'll know what all the professionals know... when you buy a Klein, it'll never let you down.

That's why we're the #1 choice of professional electricians in the U.S.



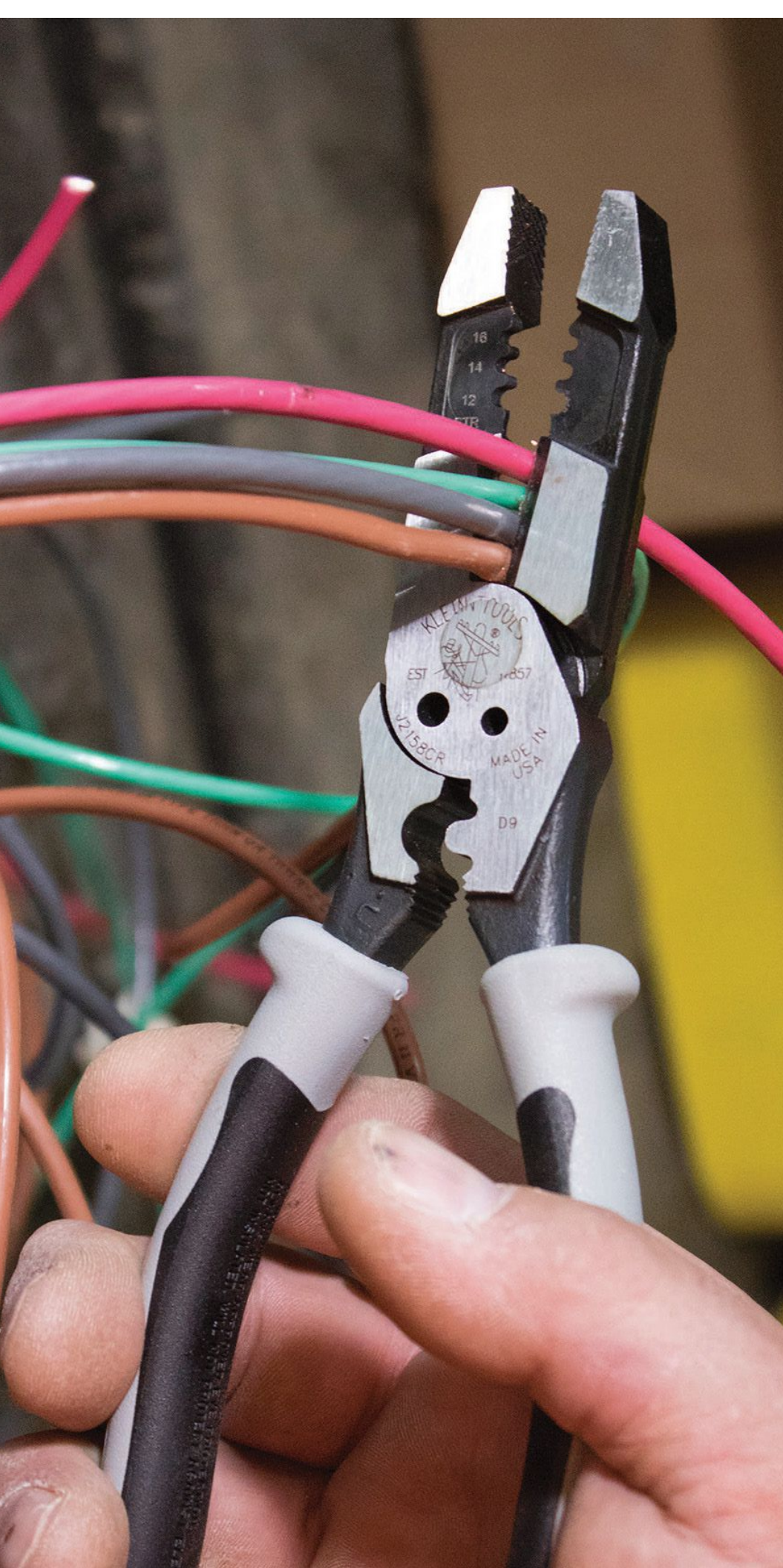

Klein Pliers

Klein specializes in the making of the world's finest pliers... pliers that professionals have trusted for more than 160 years. Klein pliers feel right and work right. They are job-matched for every kind of work you do; designed and built with exceptional quality standards in a tradition that dates back to 1857.

For Professionals...
Since 1857™

Introduction – Pliers

Klein Quality

Klein pliers are made of the finest U.S. steel alloy. Forged, precision machined, hardened, and carefully tempered for maximum strength, Klein pliers provide exceptional performance and durability.

All pliers mating surfaces and dimensions are precision machined and hot riveted for uniformly smooth opening and closing action. Cutting knives are manufactured for long-lasting edges and are designed to perfectly align and meet according to the way each is used.

Side-cutting and long-nose pliers with side cutters have knives that meet at the hinge first and then meet at least one-half of the knife length. Diagonal-cutting pliers meet at the tip first and then meet at least one-half of the knife length.

These precise knife-closing designs increase knife life and facilitate resharpening.

Klein pliers are individually adjusted to meet performance standards far exceeding application requirements – ensuring that nothing less than outstanding quality ever carries the Klein name.

Using Pliers

A professional knows all the rules about using pliers, but a review of the following points may help you recall any you may have forgotten.

- 1. Never use pliers to do another tool's job.** Pliers should not be used as a hammer or pry tool or a wrench. Using pliers instead of the proper tools risks damaging the work, damaging yourself, and losing time.
- 2. Never push pliers beyond their capacity.** Bending stiff wire with light pliers or the tip of needle-nose pliers can spring or break them. Use a stronger, blunt-nose pliers. When you need greater leverage, use pliers with greater leverage. Don't extend the length of the pliers handles. Bolts should be cut with a bolt cutter, and large cable with a cable cutter.
- 3. Never expose pliers to excessive heat.** Direct flame on metal can ruin the tool. Cutting pliers are especially vulnerable to high, direct heat.
- 4. Never cut hardened wire with ordinary pliers.** Pliers should not be used for cutting hardened wire unless they are specifically recommended for this use.
- 5. Never rock pliers from side to side when cutting wire...and never bend the wire back and forth against the cutting knives.** Either practice can dull or nick the cutting

edges. Cut wire at a right angle only. If it won't cut readily, the knives may need sharpening, or you may need pliers with greater leverage.

6. Never cut any wire or metal unless your eyes are protected. Goggles or other protective devices are an absolute must. Don't take shortcuts. Operate safely...the professional way.

7. Never cut any wire or metal unless your fellow workers' eyes are also protected. The wire that doesn't get you may get someone else. Think about the "other guy" as well as yourself.

8. Never depend on plastic-dipped handles to insulate you from electricity. Plastic-dipped and Journeyman™ handles are intended for comfort and a firmer grip only. They are not intended for protection against electric shock. Never use any pliers or cutting tools on live electrical circuits. Only use insulated tools that are marked with the official international 1000-volt rating symbol if there is any chance that the tool will make contact with an energized source.

Pliers Catalog Number Prefixes/Suffixes

"D" (Prefix) – Indicates the pliers have plastic-dipped handles for comfort, NOT for protection against electrical shock.

"HD" (Prefix) – Indicates the pliers have heavy-duty plastic-dipped handles to provide an extra level of user comfort, NOT for protection against electrical shock.

"J" (Prefix) – Indicates the pliers have state-of-the-art dual material molded Journeyman™ handles for a softer, more comfortable grip on the outer surface and a harder, more durable grip on the inner surface and handle ends, NOT for protection against electrical shock.

"C" (Suffix) – Indicates the pliers have a coil spring in the handles for self-opening action.

Pliers Cutting Edges

Knife-edge descriptions refer to the angle of the outside cutting edges of the knives when fully closed.

Standard Cutting Edges

Cuts hard wire. Found on all Klein side-cutters, long-nose, and on most diagonal-cutting pliers.



Semi-Flush Cutting Edges

Closely cuts medium wire. Found on select diagonal-cutting pliers.

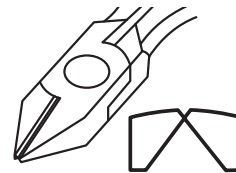

Full-Flush Cutting Edges

Close, flat cutting of soft wire only. Found on select diagonal-cutting pliers.

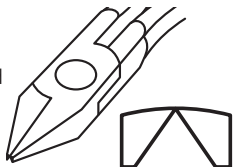



Introduction – Pliers

Pliers Dimensions

All Klein pliers are listed with necessary dimensions in both inches and millimeters. The following drawings of six basic types of pliers are keyed by letter to the dimensions given for each pliers listed. All dimensions are subject to commercial tolerances.

- | | |
|---------------------------|----------------------------|
| A – Overall Length | D – Jaw Thickness |
| B – Jaw Length | E – Knife Length |
| C – Jaw Width | F – Point Thickness |

1. Side-Cutting Pliers

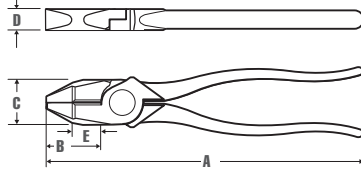

3. End Cutting Pliers

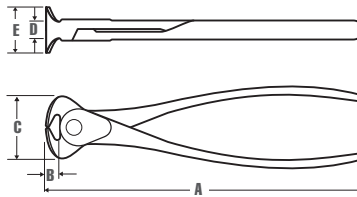

5. Flat-Nose and Duck-Bill Pliers

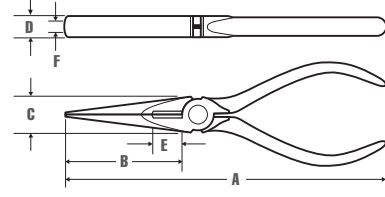

2. Diagonal-Cutting Pliers

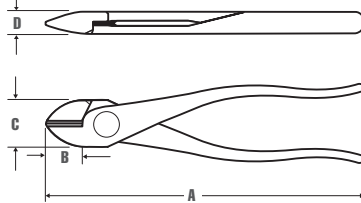

4. Long-Nose Pliers

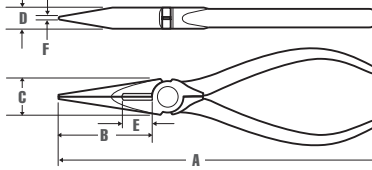

6. Curved-Nose Pliers

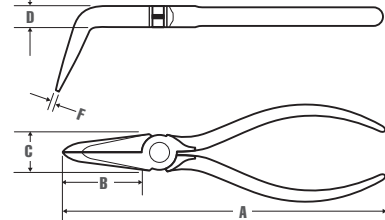

Pliers dimensions shown are accurate within accepted commercial tolerances, which allow slight variations that normally result from forging and grinding operations.

JOURNEYMAN™



State-of-the-art dual material molding process

Innovative dual material grips are more comfortable and last longer than other handles.



Hard, black material
for toughness and durability

Contoured thumb area
for additional comfort
and positive feel

Soft material on outer surface
for comfort and a firm grip

US Patent: D468988

AVAILABLE ON KLEIN SIDE-CUTTING PLIERS | DIAGONAL-CUTTING PLIERS | LONG-NOSE PLIERS | SNIPS

See page 297 for additional information on warnings.



High Leverage Side-Cutting Pliers

Rivet is closer to cutting edge

46% GREATER cutting and gripping power than other pliers designs



FORGED STEEL

from Klein's US-made, proprietary blend

Unique handle tempering helps absorb the "snap" when cutting wire

Hot-riveted joint ensures smooth action and no handle wobble

Induction hardened cutting knives for long life

Sure-gripping cross-hatched knurled jaws

Precision-hardened plier head for on-the-job toughness

Lineman's Pliers

Includes core high-leverage side-cutting features plus:

- Combination polished and black-oxide finish
- New England nose (Cat. No. J20008 has New England Tapered nose; Cat. No. D213-9 has Square nose)
- Glow in the dark grips are easily spotted in dark or low lit areas (Cat. No. D2000-9NEGLW)



D213-9NE



SPLIT TETHER RING FOR USE WITH TETHER D213-9NETT



Plain

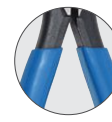

Plastic-Dipped



JOURNEYMAN™ Dual-Material



Heavy, Plastic-Dipped

Refer to the insulated section for insulated pliers.

Cat. No.	Overall Length	Jaw Length	Jaw Width	Jaw Thickness	Knife Length	Handle Color	Handle Finish	Weight
213-9NE	9.25" (235 mm)	1.594" (40.5 mm)	1.25" (31.8 mm)	5/8" (15.9 mm)	0.781" (19.8 mm)	Black	Plain	1.1 lb (0.5 kg)
D213-9	9.375" (238.1 mm)	1.594" (40.5 mm)	1.25" (31.8 mm)	1-19/32" (40.5 mm)	0.781" (19.8 mm)	Dark Blue	Plastic-Dipped	1.1 lb (0.5 kg)
D213-8NE	8.688" (220.7 mm)	1.438" (36.5 mm)	1.188" (30.2 mm)	5/8" (15.9 mm)	0.719" (18.3 mm)	Dark Blue	Plastic-Dipped	0.90 lb (0.41 kg)
D213-9NE	9.375" (238.1 mm)	1.594" (40.5 mm)	1.25" (31.8 mm)	5/8" (15.9 mm)	0.781" (19.8 mm)	Dark Blue	Plastic Dipped	1.1 lb (0.5 kg)
D213-9NETT	9.375" (238.1 mm)	1.594" (40.5 mm)	1.25" (31.8 mm)	1-19/32" (40.5 mm)	0.781" (19.8 mm)	Dark Blue	Plastic Dipped	1.1 lb (0.5 kg)
HD213-9NE	9.5" (241.3 mm)	1.594" (40.5 mm)	1.25" (31.8 mm)	5/8" (15.9 mm)	0.781" (19.8 mm)	Light Red	Heavy Plastic-Dipped	1.2 lb (0.5 kg)
J2138NE	8.813" (223.9 mm)	1.438" (36.5 mm)	1.188" (30.2 mm)	5/8" (15.9 mm)	0.719" (18.3 mm)	Dark Blue/Black	Journeyman	0.97 lb (0.44 kg)
J213-9NE	9.5" (241.3 mm)	1.594" (40.5 mm)	1.25" (31.8 mm)	5/8" (15.9 mm)	0.781" (19.8 mm)	Dark Blue/Black	Journeyman	1.1 lb (0.5 kg)
Pliers with heavy-duty cutting knives designed to cut ACSR, screws, nails and most hardened wire								
D2000-7	7.875" (200 mm)	1.281" (32.5 mm)	1.031" (26.2 mm)	1/2" (12.7 mm)	0.75" (19.1 mm)	Light Blue	Plastic-Dipped	0.66 lb (0.30 kg)
D2000-8	8.688" (220.7 mm)	1.438" (36.5 mm)	1.109" (28.2 mm)	5/8" (15.9 mm)	0.75" (19.1 mm)	Light Blue	Plastic-Dipped	0.85 lb (0.39 kg)
D2000-9NE	9.375" (238.1 mm)	1.594" (40.5 mm)	1.25" (31.8 mm)	5/8" (15.9 mm)	0.781" (19.8 mm)	Light Blue	Plastic-Dipped	1.1 lb (0.5 kg)
D20009NEGLW	9.375" (238.1 mm)	1.594" (40.5 mm)	1.25" (31.8 mm)	5/8" (15.9 mm)	0.781" (19.8 mm)	Glow in the Dark	Plastic-Dipped	1.1 lb (0.5 kg)
HD2000-9NE	9.5" (241.3 mm)	1.594" (40.5 mm)	1.25" (31.8 mm)	5/8" (15.9 mm)	0.781" (19.8 mm)	Light Red	Heavy Plastic-Dipped	1.2 lb (0.5 kg)
J20008	8.813" (223.9 mm)	1.438" (36.5 mm)	1.109" (28.2 mm)	5/8" (15.9 mm)	0.75" (19.1 mm)	Light Blue/Black	Journeyman	0.93 lb (0.42 kg)
J2000-9NE	9.5" (241.3 mm)	1.594" (40.5 mm)	1.25" (31.8 mm)	5/8" (15.9 mm)	0.781" (19.8 mm)	Light Blue/Black	Journeyman	1.1 lb (0.5 kg)





High-Leverage Side-Cutting Pliers

Fish Tape Pulling Pliers

Includes core high-leverage side-cutting features plus:

- Easily pulls 1/8" or 1/4" flat steel fish tape without damaging the tape
- Crimps non-insulated connectors, lugs, and terminals (Cat. No. J2000-9NECRTP)



D213-9NETP



Plastic-Dipped



JOURNEYMAN™
Dual-Material

Cat. No.	Overall Length	Jaw Length	Jaw Width	Jaw Thickness	Knife Length	Handle Color	Handle Finish	Weight
D213-9NETP	9.375" (238.1 mm)	1.594" (40.5 mm)	1.25" (31.8 mm)	5/8" (15.9 mm)	0.781" (19.8 mm)	Dark Blue	Plastic-Dipped	1.1 lb (0.5 kg)
J213-9NETP	9.5" (241.3 mm)	1.594" (40.5 mm)	1.25" (31.8 mm)	5/8" (15.9 mm)	0.781" (19.8 mm)	Dark Blue/Black	Journeyman	1.1 lb (0.5 kg)
Pliers with heavy-duty cutting knives designed to cut ACSR, screws, nails and most hardened wire								
D2000-9NETP	9.375" (238.1 mm)	1.594" (40.5 mm)	1.25" (31.8 mm)	5/8" (15.9 mm)	0.781" (19.8 mm)	Light Blue	Plastic-Dipped	1.1 lb (0.5 kg)
J2000-9NETP	9.5" (241.3 mm)	1.594" (40.5 mm)	1.25" (31.8 mm)	5/8" (15.9 mm)	0.781" (19.8 mm)	Light Blue/Black	Journeyman	1.1 lb (0.5 kg)
J2000-9NECRTP	9.5" (241.3 mm)	1.594" (40.5 mm)	1.25" (31.8 mm)	1-19/32" (40.5 mm)	0.781" (19.8 mm)	Blue/Black	Journeyman	1.1 lb (0.5 kg)

Bolt-Thread Holding Pliers

Includes core high-leverage side-cutting features plus:

- Hinge opening holds and cleans 5/8" pole line and hardware bolts or threaded rods



D213-9NETH



Plastic-Dipped



Heavy,
Plastic-Dipped

Cat. No.	Overall Length	Jaw Length	Jaw Width	Jaw Thickness	Knife Length	Handle Color	Handle Finish	Weight
D213-9NETH	9.375" (238.1 mm)	1.594" (40.5 mm)	1.25" (31.8 mm)	5/8" (15.9 mm)	0.781" (19.8 mm)	Dark Blue	Plastic-Dipped	1.1 lb (0.5 kg)
HD213-9NETH	9.5" (241.3 mm)	1.594" (40.5 mm)	1.25" (31.8 mm)	5/8" (15.9 mm)	0.781" (19.8 mm)	Light Red	Heavy Plastic-Dipped	1.2 lb (0.5 kg)
Pliers with heavy-duty cutting knives designed to cut ACSR, screws, nails and most hardened wire								
D2000-9NETH	9.375" (238.1 mm)	1.594" (40.5 mm)	1.25" (31.8 mm)	5/8" (15.9 mm)	0.781" (19.8 mm)	Light Blue	Plastic-Dipped	1.2 lb (0.5 kg)

Connector Crimping Pliers

Includes core high-leverage side-cutting features plus:

- Crimps non-insulated connectors, lugs and terminals
- Cleanly strips 10-12 AWG solid wire and 12-14 AWG stranded wire (Cat. No. J2139NECRN)



D213-9NECR



Plastic-Dipped



JOURNEYMAN™
Dual-Material



WIRE STRIPPING HEAD
J213-9NECRN

Cat. No.	Overall Length	Jaw Length	Jaw Width	Jaw Thickness	Knife Length	Handle Color	Handle Finish	Weight
D213-9NE-CR	9.375" (238.1 mm)	1.594" (40.5 mm)	1.25" (31.8 mm)	5/8" (15.9 mm)	0.781" (19.8 mm)	Yellow	Plastic-Dipped	1.0 lb (0.5 kg)
J213-9NECR	9.5" (241.3 mm)	1.594" (40.5 mm)	1.25" (31.8 mm)	5/8" (15.9 mm)	0.781" (19.8 mm)	Yellow/Black	Journeyman	1.1 lb (0.5 kg)
J2139NECRN	9.5" (241.3 mm)	1.594" (40.5 mm)	1.25" (31.8 mm)	5/8" (15.9 mm)	0.781" (19.8 mm)	Yellow/Black	Journeyman	1.1 lb (0.5 kg)
Pliers with heavy-duty cutting knives designed to cut ACSR, screws, nails and most hardened wire								
D2000-9NECR	9.375" (238.1 mm)	1.594" (40.5 mm)	1.25" (31.8 mm)	5/8" (15.9 mm)	0.781" (19.8 mm)	Light Blue	Plastic-Dipped	1.1 lb (0.5 kg)
J2000-9NECR	9.5" (241.3 mm)	1.594" (40.5 mm)	1.25" (31.8 mm)	5/8" (15.9 mm)	0.781" (19.8 mm)	Light Blue/Black	Journeyman	1.1 lb (0.5 kg)



Side-Cutting Pliers

Side-Cutting Pliers

- J20017NE features Journeyman™ Series dual-material handles

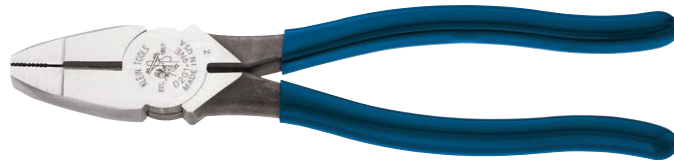

D201-9NE



Plastic-Dipped



JOURNEYMAN™ Dual-Material

Cat. No.	Overall Length	Jaw Length	Jaw Width	Jaw Thickness	Knife Length	Handle Color	Handle Finish	Weight
D201-8	8.688" (220.7 mm)	1.438" (36.5 mm)	1.219" (31 mm)	5/8" (15.9 mm)	0.719" (18.3 mm)	Dark Blue	Plastic-Dipped	0.93 lb (0.42 kg)
D201-7NE	7.438" (188.9 mm)	1.281" (32.5 mm)	1.063" (27 mm)	1/2" (12.7 mm)	0.625" (15.9 mm)	Dark Blue	Plastic-Dipped	0.55 lb (0.25 kg)
D201-8NE	8.688" (220.7 mm)	1.438" (36.5 mm)	1.188" (30.2 mm)	5/8" (15.9 mm)	0.719" (18.3 mm)	Dark Blue	Plastic-Dipped	0.92 lb (0.42 kg)
J20017NE	7.563" (192.1 mm)	1.281" (32.5 mm)	1.063" (27 mm)	1-9/32" (32.5 mm)	0.625" (15.9 mm)	Light Blue/Black	Journeyman	0.61 lb (0.28 kg)

Ironworker's Pliers

- Twists and cuts soft annealed rebar tie wire
- High-leverage design. Rivet is closer to the cutting edge for 46% greater cutting and gripping power than other pliers designs (Cat. Nos. 213-9ST, D213-9ST and D20009ST)
- Hook bend handle
- Spring-loaded action for self-opening
- Heavy-duty knurled jaws (Cat. Nos. D201-7CSTA, D213-9STT, 213-9ST, D213-9ST and D2000-9ST)



SPLIT TETHER RING FOR USE WITH TETHER
D201-7CSTT
D213-9STT



D201-7CSTA

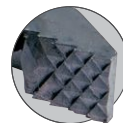

DEEPER CHANNELS ON KNURL
D201-7CSTA



Plain

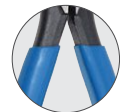

Plastic-Dipped

Cat. No.	Overall Length	Jaw Length	Jaw Width	Jaw Thickness	Knife Length	Handle Color	Handle Finish	Weight
201-7CST	9.125" (231.8 mm)	1.281" (32.5 mm)	1.156" (29.4 mm)	1/2" (12.7 mm)	0.625" (15.9 mm)	Black	Plain	0.65 lb (0.29 kg)
D201-7CST	9.25" (235 mm)	1.281" (32.5 mm)	1.156" (29.4 mm)	1/2" (12.7 mm)	0.625" (15.9 mm)	Blue	Plastic	0.75 lb (0.34 kg)
D201-7CSTA	9.25" (235 mm)	1.281" (32.5 mm)	1.156" (29.4 mm)	1-9/32" (32.5 mm)	0.625" (15.9 mm)	Red	Plastic	0.75 lb (0.34 kg)
D201-7CSTT	9" (228.6 mm)	1.5" (38.1 mm)	1.25" (31.8 mm)	1-1/2" (38.1 mm)	0.625" (15.9 mm)	Blue	Plastic	0.68 lb (0.31 kg)
213-9ST	9.25" (235 mm)	1.594" (40.5 mm)	1.25" (31.8 mm)	5/8" (15.9 mm)	0.781" (19.8 mm)	Black	Plain	1.0 lb (0.5 kg)
D213-9ST	9.375" (238.1 mm)	1.594" (40.5 mm)	1.25" (31.8 mm)	5/8" (15.9 mm)	0.781" (19.8 mm)	Blue	Plastic	1.1 lb (0.5 kg)
D213-9STT	9.375" (238.1 mm)	2" (50.8 mm)	1.25" (31.8 mm)	2" (50.8 mm)	0.781" (19.8 mm)	Blue	Plastic	1.1 lb (0.5 kg)

Pliers with heavy-duty cutting knives designed to cut ACSR, screws, nails and most hardened wire

D2000-7CST	9.25" (235 mm)	1.281" (32.5 mm)	1.156" (29.4 mm)	1/2" (12.7 mm)	0.625" (15.9 mm)	Blue	Plastic	0.70 lb (0.32 kg)
D2000-9ST	9.375" (238.1 mm)	1.594" (40.5 mm)	1.25" (31.8 mm)	5/8" (15.9 mm)	0.781" (19.8 mm)	Blue	Plastic Dipped	1.1 lb (0.5 kg)





Multifunction Pliers

Hybrid Pliers with Crimper

- Multi-purpose tool saves time and lessens the tool count
- Strips 10-14 AWG solid and 12-16 AWG stranded wire with 6-32 and 8-32 bolt shearing
- Crimps non-insulated connectors, lugs and terminals
- High-leverage design for more cutting power
- Wide knurled head easily grabs and twists wires



J215-8CR



	Cat. No.	Overall Length	Jaw Length	Jaw Width	Jaw Thickness	Knife Length	Handle Color	Handle Finish	Weight
NEW	J215-8CR	8" (203.2 mm)	2" (50.8 mm)	0.5" (12.7 mm)	0.5" (12.7 mm)	0.75" (19.05 mm)	Gray/Black	Journeyman	.062 lb (.028 kg)

High-Leverage Combination Pliers

- Crimps non-insulated connectors, lugs and terminals
- High-leverage design. Rivet is closer to the cutting edge for 46% greater cutting and gripping power than other pliers designs
- Toothed pipe-grip for greater gripping power



12098



Plastic-Dipped

JOURNEYMAN™
Dual-Material

Refer to the insulated section for insulated pliers.

	Cat. No.	Overall Length	Jaw Length	Jaw Width	Jaw Thickness	Knife Length	Handle Color	Handle Finish	Weight
	12098	8.625" (219.1 mm)	1.781" (45.2 mm)	1.031" (26.2 mm)	17/32" (13.5 mm)	0.75" (19.1 mm)	Dark Blue	Plastic-Dipped	0.72 lb (0.33 kg)
	J12098	8.75" (222.3 mm)	1.781" (45.2 mm)	1.031" (26.2 mm)	17/32" (13.5 mm)	0.75" (19.1 mm)	Dark Blue/Black	Journeyman	0.82 lb (0.37 kg)



High Leverage Diagonal-Cutting Pliers

Rivet is closer to cutting edge

36% GREATER

cutting and gripping power than other pliers designs



FORGED STEEL

from Klein's US-made, proprietary blend



Hot-riveted joint ensures smooth action and no handle wobble

Induction hardened cutting knives for long life

Short jaws and beveled cutting edges permit close cutting of wire

Diagonal-Cutting Pliers

Includes core high-leverage diagonal-cutting features plus:

- Glow in the dark grips are easily spotted in dark or low lit areas (Cat. Nos. Cat. No. D2000-28GLW and D248-8GLW)



SPLIT TETHER RING FOR USE WITH TETHER D228-8TT



D2000-28



Plastic-Dipped



JOURNEYMAN™ Dual-Material

Refer to the insulated section for insulated pliers.

Cat. No.	Overall Length	Jaw Length	Jaw Width	Jaw Thickness	Cutting Knives	Handle Color	Handle Finish	Weight
D228-7	7.125" (181 mm)	0.813" (20.7 mm)	1.188" (30.2 mm)	13/16" (20.6 mm)	Standard	Red	Plastic Dipped	0.54 lb (0.24 kg)
D228-8	8.063" (204.8 mm)	0.813" (20.7 mm)	1.188" (30.2 mm)	13/16" (20.6 mm)	Standard	Red	Plastic Dipped	0.60 lb (0.27 kg)
D228-8TT	8" (203.2 mm)	1" (25.4 mm)	1.25" (31.8 mm)	1" (25.4 mm)	Standard	Red	Plastic Dipped	0.68 lb (0.31 kg)
J228-8	8.125" (206.4 mm)	0.813" (20.7 mm)	1.188" (30.2 mm)	13/16" (20.6 mm)	Standard	Red/Black	Journeyman	0.67 lb (0.30 kg)
Pliers with heavy-duty cutting knives designed to cut ACSR, screws, nails and most hardened wire								
D2000-28	8.063" (204.8 mm)	0.813" (20.7 mm)	1.188" (30.2 mm)	13/16" (20.6 mm)	Standard	Light Blue	Plastic Dipped	0.60 lb (0.27 kg)
D2000-28GLW	8.063" (204.8 mm)	0.813" (20.7 mm)	1.188" (30.2 mm)	13/16" (20.6 mm)	Standard	Glow in the Dark	Plastic Dipped	0.60 lb (0.27 kg)
J2000-28	8.125" (206.4 mm)	0.813" (20.7 mm)	1.188" (30.2 mm)	13/16" (20.6 mm)	Standard	Light Blue/Black	Journeyman	0.67 lb (0.30 kg)

Heavy-Duty Diagonal-Cutting Pliers

Includes core high-leverage diagonal-cutting features plus:

- Extra-long cutting blades provide greater cutting ability
- Beefier, more reinforced head lasts longer than standard diagonal-cutters
- 2000 series heavy-duty cutting knives cut ACSR, screws, nails and most hardened wire
- Angled blade design for easier access to cut screws and bolts
- High-leverage design has 46% more cutting power
- Dual-material handles provide better grip and added comfort



J2000-59

Cat. No.	Overall Length	Jaw Length	Jaw Width	Jaw Thickness	Cutting Knives	Handle Color	Handle Finish	Weight
J2000-59	9" (228.6 mm)	1.25" (31.8 mm)	1.203" (30.6 mm)	5/8" (15.9 mm)	Standard	Blue/Black	Journeyman	1.0 lb (0.5 kg)





High-Leverage Diagonal-Cutting Pliers

Angled Head Diagonal Cutting Pliers

Includes core high-leverage diagonal-cutting features plus:

- Angled head design for easy work in confined spaces
- Glow in the dark grips are easily spotted in dark or low lit areas (Cat. No. D248-8GLW)

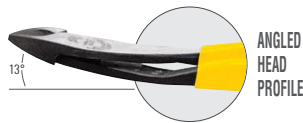

D2000-49



Plastic-Dipped



JOURNEYMAN™
Dual-Material

Refer to the insulated section for insulated pliers.

Cat. No.	Overall Length	Jaw Length	Jaw Width	Jaw Thickness	Cutting Knives	Handle Color	Handle Finish	Weight
D238-8	8.063" (204.8 mm)	0.813" (20.7 mm)	1.188" (30.2 mm)	13/16" (20.6 mm)	Semi-Flush	Red	Plastic-Dipped	0.59 lb (0.27 kg)
D248-8	8.063" (204.8 mm)	0.813" (20.7 mm)	1.188" (30.2 mm)	13/16" (20.6 mm)	Standard	Red	Plastic-Dipped	0.60 lb (0.27 kg)
D248-8-GLW	8.063" (204.8 mm)	0.813" (20.7 mm)	1.188" (30.2 mm)	13/16" (20.6 mm)	Standard	Glow in the Dark	Plastic-Dipped	0.60 lb (0.27 kg)
J248-8	8.125" (206.4 mm)	0.813" (20.7 mm)	1.188" (30.2 mm)	13/16" (20.6 mm)	Standard	Red/Black	Journeyman	0.61 lb (0.28 kg)
Pliers with heavy-duty cutting knives designed to cut ACSR, screws, nails and most hardened wire								
D2000-48	8" (203.2 mm)	0.813" (20.7 mm)	1.188" (30.2 mm)	13/16" (20.6 mm)	Standard	Blue	Plastic Dipped	0.60 lb (0.27 kg)
D2000-49	9" (228.6 mm)	0.813" (20.7 mm)	1.25" (31.8 mm)	13/16" (20.6 mm)	Standard	Yellow	Plastic Dipped	0.64 lb (0.29 kg)
J2000-48	8.125" (206.4 mm)	0.813" (20.7 mm)	1.188" (30.2 mm)	13/16" (20.6 mm)	Standard	Light Blue/Black	Journeyman	0.61 lb (0.28 kg)

Ironworker's Diagonal-Cutting Pliers

Includes core high-leverage diagonal-cutting features plus:

- Angled head design for easy working in confined spaces
- Hooked handle for improved grip



SPLIT TETHER RING
FOR USE WITH TETHER
D248-9STT



ANGLED
HEAD
PROFILE



D248-9STT

Cat. No.	Overall Length	Jaw Length	Jaw Width	Jaw Thickness	Cutting Knives	Handle Color	Handle Finish	Weight
D248-9ST	9.188" (233.4 mm)	0.813" (20.7 mm)	1.188" (30.2 mm)	13/16" (20.6 mm)	Standard	Red	Plastic Dipped	0.68 lb (0.31 kg)
D248-9STT	9" (228.6 mm)	1" (25.4 mm)	1.25" (31.8 mm)	1" (25.4 mm)	Standard	Red	Plastic Dipped	0.68 lb (0.31 kg)

Diagonal-Cutting Pliers with Stripping Holes

Includes core high-leverage diagonal-cutting features plus:

- Cleanly strips 12-14 AWG solid wire



D243-8

Cat. No.	Overall Length	Jaw Length	Jaw Width	Jaw Thickness	Cutting Knives	Handle Color	Handle Finish	Weight
D243-8	8.063" (204.8 mm)	0.813" (20.7 mm)	1.188" (30.2 mm)	13/16" (20.6 mm)	Standard	Red	Plastic-Dipped	0.60 lb (0.27 kg)

See page 297 for additional information on warnings.



Diagonal-Cutting Pliers

Heavy-Duty Diagonal-Cutting Pliers - Tapered Nose

- Heavier design for all-purpose use
- Tapered nose for easy working in confined areas



D220-7

Cat. No.	Overall Length	Jaw Length	Jaw Width	Jaw Thickness	Cutting Knives	Handle Color	Handle Finish	Weight
D220-7	7.688" (195.3 mm)	1" (25.4 mm)	0.969" (24.6 mm)	1" (25.4 mm)	Standard	Red	Plastic-Dipped	0.54 lb (0.24 kg)
D252-6	6.125" (155.6 mm)	0.813" (20.7 mm)	0.75" (19.1 mm)	13/16" (20.6 mm)	Standard	Red	Plastic-Dipped	0.38 lb (0.17 kg)
Bell System Type "W" Notches - Slits insulation cleanly								
D252-6SW	6.125" (155.6 mm)	0.813" (20.7 mm)	0.75" (19.1 mm)	13/16" (20.6 mm)	Standard	Red	Plastic-Dipped	0.33 lb (0.15 kg)

Standard Diagonal-Cutting Pliers

- Tapered nose for easy working in confined areas and close tip cutting
- Trims plastic or printed circuit boards (Cat. D210-6C)
- Cleanly strips 16 AWG solid wire (Cat. No. D240-6)



D245-5

Cat. No.	Overall Length	Jaw Length	Jaw Width	Jaw Thickness	Cutting Knives	Handle Color	Handle Finish	Weight
D202-6	6.125" (155.6 mm)	0.813" (20.7 mm)	0.688" (17.5 mm)	13/16" (20.6 mm)	Standard	Red	Plastic-Dipped	0.29 lb (0.13 kg)
D202-6C	6.125" (155.6 mm)	0.813" (20.7 mm)	0.688" (17.5 mm)	13/16" (20.6 mm)	Standard	Red	Plastic-Dipped	0.31 lb (0.14 kg)
D245-5	5.063" (128.6 mm)	0.688" (17.5 mm)	0.563" (14.3 mm)	11/16" (17.5 mm)	Standard	Red	Plastic-Dipped	0.20 lb (0.09 kg)
D210-6C	6.125" (155.6 mm)	0.813" (20.7 mm)	0.688" (17.5 mm)	13/16" (20.6 mm)	Semi-Flush	Red	Plastic-Dipped	0.29 lb (0.13 kg)
D240-6	6.125" (155.6 mm)	0.813" (20.7 mm)	0.688" (17.5 mm)	13/16" (20.6 mm)	Standard	Red	Plastic-Dipped	0.30 lb (0.14 kg)
Bell-System Type "W" & "V" Notches - For quick insulation slitting								
D528V	5.813" (147.7 mm)	0.813" (20.7 mm)	0.563" (14.3 mm)	13/16" (20.6 mm)	Standard	Red	Plastic-Dipped	0.20 lb (0.09 kg)
Telephone Type D-6 "V" Notches - For quick insulation slitting and includes .030" and .045" stripping holes								
72192	6.125" (155.6 mm)	0.813" (20.7 mm)	0.75" (19.1 mm)	13/16" (20.6 mm)	Standard	Red	Plastic-Dipped	0.33 lb (0.15 kg)

Electronics Diagonal-Cutting Pliers

Midget Diagonal-Cutting Pliers

- Sharp pointed nose for precise tip cutting
- Tapered nose for easy working in confined areas and close tip cutting (Cat No. D295-4C, D257-4 & D257-4C)
- Spring-loaded for self-opening action (Not available on Cat. No. D257-4)
- Narrow jaw and hinge for delicate work in tight areas (Cat. No. D259-4C & D244-5C)
- Miniature jaw for close-quarter work with maximum visibility (Cat. No. D295-4C)



D257-4C



Tapered Nose Standard Jaw Tapered Nose Mini Jaw Pointed Nose Standard Jaw Pointed Nose Narrow Jaw Pointed Nose Extra Narrow Jaw

Cat. No.	Overall Length	Jaw Length	Jaw Width	Jaw Thickness	Cutting Knives	Handle Color	Handle Finish	Weight
D209-4C	4.25" (108 mm)	0.5" (12.7 mm)	0.438" (11.1 mm)	1/2" (12.7 mm)	Semi-Flush	Light Blue	Plastic-Dipped	0.13 lb (0.06 kg)
D209-5C	5.063" (128.6 mm)	0.688" (17.5 mm)	0.563" (14.3 mm)	11/16" (17.5 mm)	Semi-Flush	Light Blue	Plastic-Dipped	0.19 lb (0.09 kg)
D244-5C	5.063" (128.6 mm)	0.688" (17.5 mm)	0.5" (12.7 mm)	11/16" (17.5 mm)	Flush	Light Blue	Plastic-Dipped	0.18 lb (0.08 kg)
D259-4C	4.25" (108 mm)	0.5" (12.7 mm)	0.406" (10.3 mm)	1/2" (12.7 mm)	Flush	Light Blue	Plastic-Dipped	0.12 lb (0.05 kg)
D257-4	4.25" (108 mm)	0.5" (12.7 mm)	0.438" (11.1 mm)	1/2" (12.7 mm)	Semi-Flush	Light Blue	Plastic-Dipped	0.12 lb (0.05 kg)
D257-4C	4.25" (108 mm)	0.5" (12.7 mm)	0.438" (11.1 mm)	1/2" (12.7 mm)	Semi-Flush	Light Blue	Plastic-Dipped	0.12 lb (0.05 kg)
D295-4C	4.25" (108 mm)	0.5" (12.7 mm)	0.375" (9.5 mm)	1/2" (12.7 mm)	Flush	Light Blue	Plastic-Dipped	0.11 lb (0.05 kg)





Electronics Diagonal-Cutting Pliers

Midget Diagonal-Cutting Pliers - Nickel Ribbon Wire Cutters

- Designed to cut nickel ribbon wire
- Nose tip is only 1/32" (0.8 mm) for precise work in confined areas
- Cutting knife tip is 3/16" (5 mm) long for precise cutting
- Spring-loaded action for self-opening



D230-4C

Cat. No.	Overall Length	Jaw Length	Jaw Width	Jaw Thickness	Cutting Knives	Handle Color	Handle Finish	Weight
D230-4C	4.25" (108 mm)	0.5" (12.7 mm)	0.438" (11.1 mm)	1/2" (12.7 mm)	Semi-Flush	Light Blue	Plastic-Dipped	0.12 lb (0.05 kg)

Precision Flush Cutter

- Shears wire up to 16 AWG producing a flat, flush cut
- Shear cutting greatly reduces cutting effort and minimizes fly-off
- Molded flared grips for greater tool control
- Steel return spring for increased comfort during repetitive cutting
- Ultra slim profile increases access in confined areas
- Heat treated for increased durability



D275-5

Cat. No.	Overall Length	Jaw Length	Jaw Width	Jaw Thickness	Cutting Knives	Handle Color	Handle Finish	Weight
D275-5	5" (127.0 mm)	0.45" (11.4 mm)	0.26" (6.6 mm)	0.086" (2.2 mm)	Flush	Red	Plastic	0.11 lb (0.05 kg)

Diagonal-Cutting Specialty Pliers

Plastic-Cutting Pliers

Includes core diagonal-cutting features plus:

- Precisely cuts injection mold sprues, gates and other plastic
- Adjustable 1/16" hollow-head screw keeps knife-edges from damaging each other (not designed for use on metal)
- Spring-loaded for self-opening action



D227-7C

Cat. No.	Overall Length	Jaw Length	Jaw Width	Jaw Thickness	Cutting Knives	Handle Color	Handle Finish	Weight
D227-7C	7.688" (195.3 mm)	1" (25.4 mm)	0.969" (24.6 mm)	1" (25.4 mm)	Flush	Red	Plastic-Dipped	0.55 lb (0.25 kg)



Side-Cutting Long-Nose Pliers



FORGED STEEL
from Klein's US-made, proprietary blend

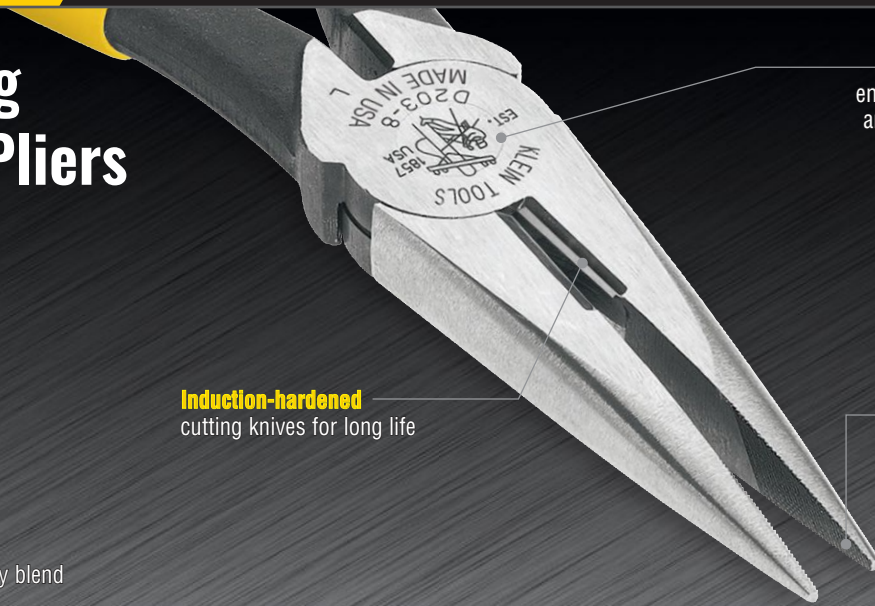

Hot-riveted joint
ensures smooth action and no handle wobble

Induction-hardened
cutting knives for long life

Slim head design
for working in confined areas

All-Purpose Pliers

Includes core features plus:

- Strips 8-16 AWG solid and 10-18 AWG stranded wire (Cat. No. J206-8C)
- Strips 10-18 AWG solid and 12-20 AWG stranded wire and crimps non-insulated connectors, lugs and terminals (Cat. No. J207-8CR)
- Knurled jaw for grabbing and looping wire
- 6-32 and 8-32 screw shearing



J206-8C



CRIMPING FEATURE
J207-8CR

Cat. No.	Overall Length	Jaw Length	Jaw Width	Jaw Thickness	Point Diameter	Knife Length	Handle Color	Handle Finish	Weight
J206-8C	8.625" (219.1 mm)	2.188" (55.6 mm)	1" (25.4 mm)	1/2" (12.7 mm)	1/8" (3.18 mm)	0.5" (12.7 mm)	Yellow/Black	Journeyman	0.60 lb (0.27 kg)
J207-8CR	8.625" (219.1 mm)	2.188" (55.6 mm)	1" (25.4 mm)	1/2" (12.7 mm)	1/8" (3.18 mm)	0.5" (12.7 mm)	Yellow/Black	Journeyman	0.60 lb (0.27 kg)

Heavy-Duty Side-Cutting Long-Nose Pliers

Includes core long-nose features plus:

- Heavier design for greater cutting power
- Extended handles provide added reach and greater leverage
- Glow in the dark grips are easily spotted in dark or low lit areas (Cat. No. D2303-8GLW)

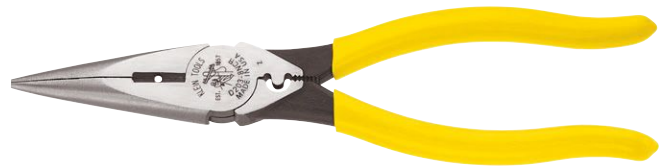

D203-8NCR

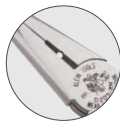

12 AWG WIRE STRIPPING
D203-8N
J203-8N



12 AWG WIRE STRIPPING AND CRIMPING
D203-8NCR



Plastic-Dipped



JOURNEYMAN™
Dual-Material

Refer to the insulated section for insulated pliers.

Cat. No.	Overall Length	Jaw Length	Jaw Width	Jaw Thickness	Point Diameter	Knife Length	Handle Color	Handle Finish	Weight
D203-8	8.438" (214.3 mm)	2.313" (58.8 mm)	1" (25.4 mm)	1/2" (12.7 mm)	1/8" (3.18 mm)	0.625" (15.9 mm)	Yellow	Plastic-Dipped	0.60 lb (0.27 kg)
D203-8-GLW	8.438" (214.3 mm)	2.313" (58.8 mm)	1" (25.4 mm)	1/2" (12.7 mm)	1/8" (3.18 mm)	0.625" (15.9 mm)	Glow in the Dark	Plastic-Dipped	0.60 lb (0.27 kg)
J203-8	8.563" (217.5 mm)	2.313" (58.8 mm)	1" (25.4 mm)	1/2" (12.7 mm)	1/8" (3.18 mm)	0.625" (15.9 mm)	Yellow/Black	Journeyman	0.63 lb (0.29 kg)
D203-8N	8.438" (214.3 mm)	2.313" (58.8 mm)	1" (25.4 mm)	1/2" (12.7 mm)	1/8" (3.18 mm)	0.625" (15.9 mm)	Yellow	Plastic-Dipped	0.59 lb (0.27 kg)
J203-8N	8.563" (217.5 mm)	2.313" (58.8 mm)	1" (25.4 mm)	1/2" (12.7 mm)	1/8" (3.18 mm)	0.625" (15.9 mm)	Yellow/Black	Journeyman	0.64 lb (0.29 kg)
D203-8NCR	8.438" (214.3 mm)	2.313" (58.8 mm)	1" (25.4 mm)	1/2" (12.7 mm)	1/8" (3.18 mm)	0.625" (15.9 mm)	Yellow	Plastic-Dipped	0.61 lb (0.28 kg)





Side-Cutting Long-Nose Pliers

Side-Cutting Long-Nose Pliers

Includes core long-nose features plus:

- Knurled jaws for grabbing and looping wire
- Curved handles provide greater tool control
- Spring-loaded action for self-opening (Cat. Nos. D203-6C, D203-7C)



19 & 22 AWG
WIRE STRIPPING
D203-6H2

Refer to the insulated section for insulated pliers.



D203-6C



Plastic-Dipped



JOURNEYMAN™
Dual-Material

Cat. No.	Overall Length	Jaw Length	Jaw Width	Jaw Thickness	Point Diameter	Knife Length	Handle Color	Handle Finish	Weight
D203-6	6.625" (168.3 mm)	1.875" (47.6 mm)	0.688" (17.5 mm)	3/8" (9.5 mm)	3/32" (2.38 mm)	0.5" (12.7 mm)	Yellow	Plastic-Dipped	0.27 lb (0.12 kg)
D203-6C	6.625" (168.3 mm)	1.875" (47.6 mm)	0.688" (17.5 mm)	3/8" (9.5 mm)	3/32" (2.38 mm)	0.5" (12.7 mm)	Yellow	Plastic-Dipped	0.27 lb (0.12 kg)
D203-7	7.188" (182.6 mm)	2.438" (61.9 mm)	0.688" (17.5 mm)	3/8" (9.5 mm)	3/32" (2.38 mm)	0.5" (12.7 mm)	Yellow	Plastic-Dipped	0.29 lb (0.13 kg)
D203-7C	7.188" (182.6 mm)	2.438" (61.9 mm)	0.688" (17.5 mm)	3/8" (9.5 mm)	3/32" (2.38 mm)	0.5" (12.7 mm)	Yellow	Plastic-Dipped	0.29 lb (0.13 kg)
J203-6	6.75" (171.5 mm)	1.875" (47.6 mm)	0.688" (17.5 mm)	3/8" (9.5 mm)	3/32" (2.4 mm)	0.5" (12.7 mm)	Yellow/Black	Journeyman	0.30 lb (0.14 kg)
J203-7	7.313" (185.8 mm)	2.438" (61.9 mm)	0.688" (17.5 mm)	3/8" (9.5 mm)	3/32" (2.4 mm)	0.5" (12.7 mm)	Yellow/Black	Journeyman	0.33 lb (0.15 kg)
D203-6H2	6.625" (168.3 mm)	1.875" (47.6 mm)	0.688" (17.5 mm)	3/8" (9.5 mm)	3/32" (2.4 mm)	0.5" (12.7 mm)	Yellow	Plastic-Dipped	0.26 lb (0.12 kg)

Long-Nose Pliers

Long-Nose Pliers

- Knurled jaws for grabbing and looping wire
- Curved handles provide greater tool control
- Spring-loaded action for self-opening (Cat. No. D301-6C)



D301-6

Cat. No.	Overall Length	Jaw Length	Jaw Width	Jaw Thickness	Point Diameter	Handle Color	Handle Finish	Weight
D301-6	6.625" (168.3 mm)	1.875" (47.6 mm)	0.688" (17.5 mm)	3/8" (9.5 mm)	3/32" (2.38 mm)	Yellow	Plastic-Dipped	0.29 lb (0.13 kg)
D301-6C	6.625" (168.3 mm)	1.875" (47.6 mm)	0.688" (17.5 mm)	3/8" (9.5 mm)	3/32" (2.38 mm)	Yellow	Plastic-Dipped	0.28 lb (0.13 kg)

Slim Long-Nose Pliers

- Longer nose and handles for deeper reach into work
- Spring-loaded for self-opening action
- Curved handles provide greater tool control



D307-5 1/2C

Cat. No.	Overall Length	Jaw Length	Jaw Width	Jaw Thickness	Point Diameter	Handle Color	Handle Finish	Weight
D307-51/2C	5.625" (142.9 mm)	1.688" (42.9 mm)	0.5" (12.7 mm)	5/16" (7.9 mm)	1/32" (.79 mm)	Yellow	Plastic-Dipped	0.15 lb (0.07 kg)
D327-51/2C	5.625" (142.9 mm)	1.688" (42.9 mm)	0.5" (12.7 mm)	5/16" (7.9 mm)	1/16" (1.58 mm)	Dark Blue	Plastic-Dipped	0.15 lb (0.07 kg)

See page 297 for additional information on warnings.



Electronics Long-Nose Pliers

Midget Slim Long-Nose Pliers

- Lightweight, slim-nose pliers for precision subminiature assembly work
- Knurled jaws for grabbing and looping wire
- Curved handles provide greater tool control
- Spring-loaded action for self-opening



D322-4 1/2C

Cat. No.	Overall Length	Jaw Length	Jaw Width	Jaw Thickness	Point Diameter	Handle Color	Handle Finish	Weight
D321-41/2C	4.813" (122.3 mm)	1.063" (27 mm)	0.438" (11.1 mm)	1/4" (6.4 mm)	1/32" x 1/16" (.79 mm x 1.58 mm)	Light Blue	Plastic-Dipped	0.13 lb (0.06 kg)
D322-41/2C	4.813" (122.3 mm)	1.063" (27 mm)	0.438" (11.1 mm)	1/4" (6.4 mm)	1/32" x 1/16" (.79 mm x 1.58 mm)	Light Blue	Plastic-Dipped	0.13 lb (0.06 kg)

Long Needle-Nose Pliers

- Designed for accurate work in hard-to-reach areas
- Knurled jaws for grabbing and looping wire
- Spring-loaded for self-opening action
- Curved handles provide greater tool control
- Extra-slim hinge for extremely close quarter work (Cat. No. D355-51/2C)

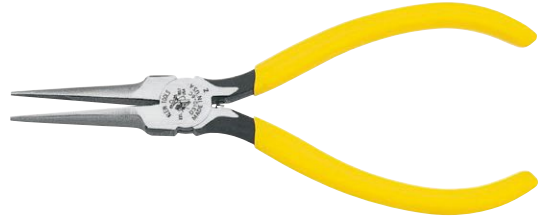

D310-6C

Cat. No.	Overall Length	Jaw Length	Jaw Width	Jaw Thickness	Point Diameter	Handle Color	Handle Finish	Weight
D310-6C	6.625" (168.3 mm)	1.875" (47.6 mm)	0.688" (17.5 mm)	3/8" (9.5 mm)	1/16" (1.58 mm)	Yellow	Plastic-Dipped	0.27 lb (0.12 kg)
D318-51/2C	5.625" (142.9 mm)	1.688" (42.9 mm)	0.5" (12.7 mm)	5/16" (7.9 mm)	1/16" (1.58 mm)	Yellow	Plastic-Dipped	0.13 lb (0.06 kg)
D335-51/2C	5.625" (142.9 mm)	1.688" (42.9 mm)	0.469" (11.9 mm)	1/4" (6.4 mm)	1/16" (1.58 mm)	Light Blue	Plastic-Dipped	0.13 lb (0.06 kg)

Curved Long-Nose Pliers

- 70° bent nose for maximum work visibility in confined areas
- Knurled jaws for grabbing and looping wire
- Curved handles provide greater tool control



D302-6

Cat. No.	Overall Length	Jaw Length	Jaw Width	Jaw Thickness	Point Diameter	Handle Color	Handle Finish	Weight
D302-6	6.375" (161.9 mm)	1.5" (38.1 mm)	0.688" (17.5 mm)	3/8" (9.5 mm)	3/32" (2.38 mm)	Yellow	Plastic Dipped	0.30 lb (0.14 kg)

Midget Curved Chain-Nose Pliers

- 60° bent nose for maximum work visibility in confined areas
- Easily bends and forms fine wire
- Polished inside jaws and radiused jaw edges prevent nicking wire
- Spring-loaded for self-opening action
- Curved handles provide greater tool control



D320-4 1/2C

Cat. No.	Overall Length	Jaw Length	Jaw Width	Jaw Thickness	Point Diameter	Handle Color	Handle Finish	Weight
D320-41/2C	4.75" (120.7 mm)	1" (25.4 mm)	0.406" (10.3 mm)	1/4" (6.4 mm)	1/16" (1.58 mm)	Light Blue	Plastic-Dipped	0.13 lb (0.06 kg)





Telecom Pliers

Long-Nose Pliers - Connector Crimping

- Crimps UR/UY/UG insulation displacement connectors (IDC) - Scotchlok® type connectors
- Cleanly strips 23-24 AWG wire
- Grooved jaws for wire wrapping, looping and twisting
- Hot-riveted joint ensures smooth action and no handle wobble
- Induction-hardened cutting surface for long life



VDV026-049

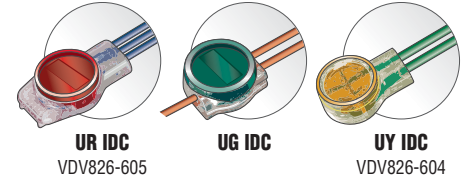

UR IDC
VDV826-605

UG IDC

UY IDC
VDV826-604

Cat. No.	Overall Length	Jaw Length	Jaw Width	Jaw Thickness	Point Diameter	Knife Length	Handle Color	Handle Finish	Weight
VDV026-049	6.8" (173 mm)	2" (51 mm)	0.7" (18 mm)	0.4 (10 mm)	0.095" x 0.125" (2.41 mm x 3.17 mm)	0.44" (11 mm)	Yellow	Plastic Dipped	0.28 lb (0.13 kg)

Scotchlok® is a registered trademark of 3M Corporation

Connector Crimping Pliers

- Crimps and seats UR/UY/UG insulation displacement connectors (IDC) - Scotchlok® type connectors
- Curved handles for greater control
- Induction-hardened side-cutting knives for long life
- Spring-loaded action for self-opening (Cat. No. D234-6C)



D234-6

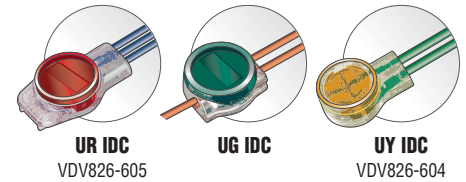

UR IDC
VDV826-605

UG IDC

UY IDC
VDV826-604

Cat. No.	Overall Length	Jaw Length	Jaw Width	Jaw Thickness	Knife Length	Handle Color	Handle Finish	Weight
D234-6	5.813" (147.7 mm)	1.094" (27.8 mm)	0.688" (17.5 mm)	3/8" (9.5 mm)	0.5" (12.7 mm)	Yellow	Plastic Dipped	0.25 lb (0.11 kg)
D234-6C	5.813" (147.7 mm)	1.094" (27.8 mm)	0.688" (17.5 mm)	3/8" (9.5 mm)	0.5" (12.7 mm)	Yellow	Plastic Dipped	0.25 lb (0.11 kg)

Scotchlok® is a registered trademark of 3M.

Standard Long-Nose Pliers - Switchboard Work

- Cleanly strips 19 & 22 AWG wire
- Induction-hardened, long-lasting cutting knives
- Knurled jaws for sure wrapping and looping
- Curved handles provide greater tool control



D203-6H2

Cat. No.	Overall Length	Jaw Length	Jaw Width	Jaw Thickness	Point Diameter	Knife Length	Handle Color	Handle Finish	Weight
D203-6H2	6.625" (168.3 mm)	1.875" (47.6 mm)	0.688" (17.5 mm)	3/8" (9.5 mm)	3/32" (2.4 mm)	0.5" (12.7 mm)	Yellow	Plastic-Dipped	0.26 lb (0.12 kg)

See page 297 for additional information on warnings.



Telecom Long-Nose Pliers

Long-Nose Telephone Work Pliers-Type L1

- Knurled jaw tips for greater gripping power
- Induction-hardened side-cutting knives for long life
- Convenient 0.030" stripping hole
- Curved handles provide greater tool control



71980

Cat. No.	Overall Length	Jaw Length	Jaw Width	Jaw Thickness	Point Diameter	Knife Length	Handle Color	Handle Finish	Weight
71980	6.625" (168.3 mm)	1.875" (47.6 mm)	0.688" (17.5 mm)	3/8" (9.5 mm)	1/16" x 3/32" (1.6 mm x 2.4 mm)	0.5" (12.7 mm)	Yellow	Plastic-Dipped	0.25 lb (0.11 kg)

Long-Nose Telephone Work Pliers - Stripping

- Cleanly strips 22 to 24 AWG wire
- Convenient insulation crushing slot
- Curved handles provide greater tool control



D2291

Cat. No.	Overall Length	Jaw Length	Jaw Width	Jaw Thickness	Point Diameter	Handle Color	Handle Finish	Weight
D2291	6" (152.4 mm)	1.25" (31.8 mm)	0.688" (17.5 mm)	3/8" (9.5 mm)	1/16" x 3/32" (1.6 mm x 2.4 mm)	Yellow	Plastic-Dipped	0.25 lb (0.11 kg)

Specialty Pliers

Conduit Locknut and Reaming Pliers

- Tightens 1/2" (13 mm) and 3/4" (19 mm) EMT or 1/2" (13 mm) rigid locknuts
- Fits liquid tight fittings and caps
- Reams and deburrs both inside and outside of conduit
- Knurled jaws at nose tip pull wire or fish tape
- Machined nose fits snugly into locknut wings



D333-8

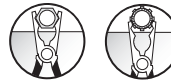

Cat. No.	Overall Length	Jaw Length	Jaw Width	Jaw Thickness	Point Diameter	Handle Color	Handle Finish	Weight
D333-8	7.75" (196.9 mm)	1.625" (41.3 mm)	0.938" (23.8 mm)	1/2" (12.7 mm)	3/16" (4.8 mm)	Yellow	Plastic-Dipped	0.55 lb (0.25 kg)

End-Cutting Pliers

- Wide throat clearance for clean, even cutting of wire or nails at close range
- High-leverage design provides greater cutting power at the knives than other plier designs
- Extended handles for longer reach and increased leverage



D232-8

Cat. No.	Overall Length	Jaw Length	Jaw Width	Jaw Thickness	Knife Length	Handle Color	Handle Finish	Weight
D232-8	8.5" (215.9 mm)	0.375" (9.5 mm)	1.188" (30.2 mm)	3/8" (9.5 mm)	1.188" (30.2 mm)	Red	Plastic-Dipped	0.71 lb (0.32 kg)





Pump Pliers

Klaw™ Pump Pliers

- Compact, narrow design for easy work in small or hard to reach spaces
- Gripping surfaces with specially hardened teeth for reduced wear and positive gripping
- Extended grips for added comfort
- **Quick-Adjust Pump Pliers:** Push button and quick ratchet feature allows for fast and easy adjustment to any position. (Cat. Nos. D504-10B, D504-12B)



D504-10



Cat. No.	Overall Length	Jaw Capacity	Handle Color	Handle Finish	Weight
Quick-Adjust Klaw™ Pump Pliers					
D504-10B	10.125" (257.2 mm)	2-1/8" (54.0 mm)	Yellow	Plastic-Dipped	0.79 lb (0.36 kg)
D504-12B	12.5" (317.5 mm)	2-3/4" (69.9 mm)	Yellow	Plastic-Dipped	1.2 lb (0.5 kg)
Classic Klaw™ Pump Pliers					
D504-7	7.375" (187.3 mm)	1-3/8" (34.9 mm)	Yellow	Plastic-Dipped	0.34 lb (0.15 kg)
D504-10	9.875" (250.8 mm)	2-1/8" (54.0 mm)	Yellow	Plastic-Dipped	0.81 lb (0.37 kg)
D504-12	12" (304.8 mm)	2-3/4" (69.9 mm)	Yellow	Plastic-Dipped	1.4 lb (0.6 kg)

Pump Pliers

- Secure tongue and groove design for non-slip grip - even with heavy pressure
- Wide range of versatile jaw positions
- Quick adjust rivet allows one handed, fast and easy adjustment of plier jaws
- TT Series feature split tether ring for securing tool when working at height



D502-6



**SPLIT TETHER RING
FOR USE WITH TETHER**
D502-6TT
D502-10TT
D502-12TT



Plastic-Dipped



JOURNEYMAN™
Dual-Material

Cat. No.	Overall Length	Jaw Capacity	Handle Color	Handle Finish	Weight
D502-6	6.5" (165.1 mm)	7/8" (22.2 mm)	Yellow	Plastic-Dipped	0.41 lb (0.19 kg)
D502-6TT	8" (203.2 mm)	7/8" (22.2 mm)	Yellow	Plastic-Dipped	0.41 lb (0.19 kg)
D502-10	10" (254.0 mm)	1-3/4" (44.5 mm)	Yellow	Plastic-Dipped	0.97 lb (0.44 kg)
D502-10TT	11.25" (285.8 mm)	1-3/4" (44.5 mm)	Yellow	Plastic Dipped	0.95 lb (0.43 kg)
D502-12	12.25" (311.2 mm)	2-3/8" (60.3 mm)	Yellow	Plastic-Dipped	1.4 lb (0.6 kg)
D502-12TT	13" (330.2 mm)	2-3/8" (60.3 mm)	Yellow	Plastic Dipped	1.4 lb (0.6 kg)
D502-16	16.25" (412.8 mm)	4-1/4" (108.0 mm)	Yellow	Plastic-Dipped	3.2 lb (1.5 kg)
J502-10	10.25" (260.4 mm)	1-3/4" (44.5 mm)	Yellow/Black	Journeyman	1.0 lb (0.5 kg)



Slip-Joint Pliers

Slip-Joint Pliers

- Shear-type cutter for precision wire cutting
- Two versatile jaw positions
- Serrated jaws provide sure-gripping power
- Nickel-chrome plated for long life



D511-6

Cat. No.	Overall Length	Jaw Length	Jaw Width	Jaw Thickness	Handle Color	Handle Finish	Weight
D511-6	6.563" (166.7 mm)	1.188" (30.2 mm)	1.188" (30.2 mm)	3/8" (9.5 mm)	Blue	Plastic-Dipped	0.39 lb (0.18 kg)
D511-8	8.063" (204.8 mm)	1.375" (34.9 mm)	1.25" (31.8 mm)	7/16" (11.1 mm)	Blue	Plastic-Dipped	0.62 lb (0.28 kg)
D511-10	9.875" (250.8 mm)	1.75" (44.5 mm)	1.375" (34.9 mm)	15/32" (11.9 mm)	Blue	Plastic-Dipped	0.83 lb (0.38 kg)

Slip-Joint Pliers - Hose Clamp

- Quickly installs and removes spring-tension hose clamps
- Grips with either end or side of jaws for work in confined areas
- Nickel-chrome plated for long life



D514-8

Cat. No.	Overall Length	Jaw Length	Jaw Width	Jaw Thickness	Handle Color	Handle Finish	Weight
D514-8	8.063" (204.8 mm)	1.375" (34.9 mm)	1.25" (31.8 mm)	7/16" (11.1 mm)	Blue	Plastic-Dipped	0.61 lb (0.28 kg)

Pliers Handles

Replacement Klein-Koat™ Pliers Handles

- Plastic material for slip-resistant grip and comfort



70

Cat. No.	Size to Fit Pliers	Color	Weight
60	6" (152.4 mm) Long	Red	0.80 oz (22.7 g)
70	7" (177.8 mm) Long	Red	0.10 lb (0.05 kg)
89	8" to 9" (203.2 to 228.6 mm) Long	Red	0.10 lb (0.05 kg)





Strippers, Cutters and Crimpers

Manufactured with the needs of the professional tool user in mind, Klein strippers, cutters, and crimpers are designed to get jobs done with precision and quality.

For Professionals...
Since 1857™

Cable Strippers

Large Cable Strippers

- Effectively removes cable insulation
- Quicker and safer than using a knife
- Clover design features 4 different wire sizes in one tool
- Ensures precise cuts every time



21050

	Cat. No.	Cable Size	Strip Dimensions	Weight
NEW	21050	MTW/THHN/THWN-2	350 MCM, 500 MCM, 600 MCM, 750 MCM	1.2 lb (0.5 kg)
NEW	21051	MTW/THHN/THWN-2	2/0, 3/0, 4/0, 250 MCM	1.1 lb (0.5 kg)

Heavy-Duty Forged Wire Strippers

KLEIN-KURVE™
comfort grip handles
for reduced hand fatigue

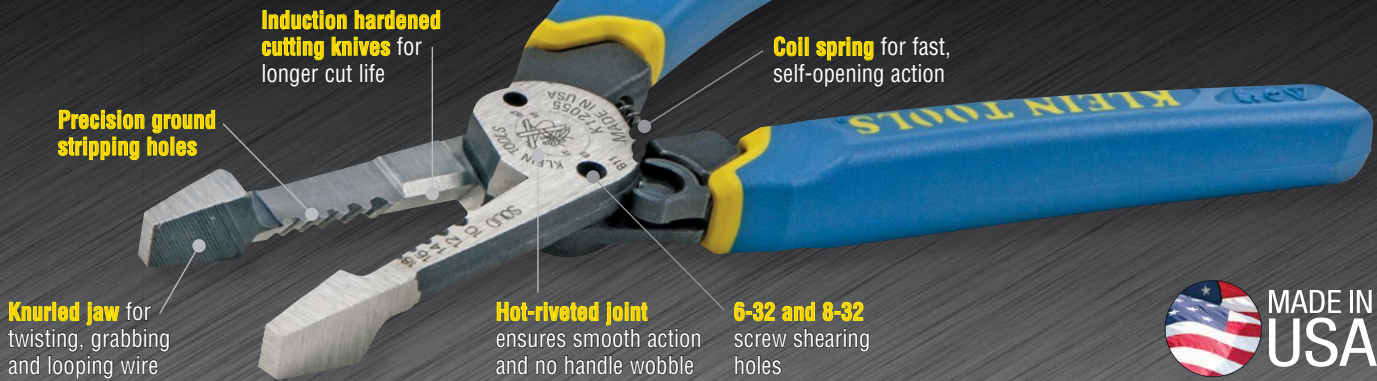

Heavy-Duty Wire Strippers

Includes core features plus:

- The durability of a plier with the sharpness and precision of a wire stripper
- Robust forged steel makes this 4 times stronger than traditional wire strippers
- Twist up to three wires at a time



K12054

Cat. No.	Strips and Cuts	Screw Shearing	Overall Length	Handle Color	Weight
K12054	8-16 AWG Solid (10-1.5 mm ²); 10-18 AWG Stranded (6-1.0 mm ²)	6-32 and 8-32	8" (203 mm)	Blue/White	0.63 lb (0.29 kg)
K12055	10-18 AWG Solid (6.0-1.0 mm ²); 12-20 AWG Stranded (4.0-0.50 mm ²)	6-32 and 8-32	8" (203 mm)	Blue/Yellow	0.63 lb (0.29 kg)





Wire Strippers/Cutters

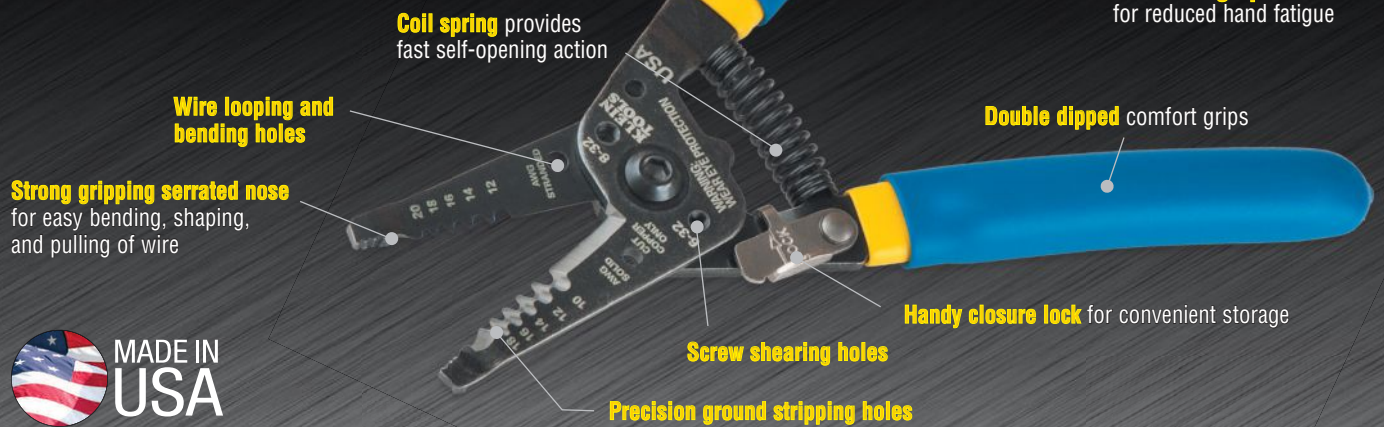

Klein-Kurve™ Wire Strippers/Cutters

Includes core features plus:

- Easy-to-read markings
- Precision shear-type blades
- Narrow nose fits into tight places
- Glow in the dark grips to easily locate your tool in dark or low lit areas (Cat. No. 11054GLW)



11054

Cat. No.	Strips and Cuts	Screw Shearing	Overall Length	Handle Color	Weight
11053	6-12 AWG Stranded (16.0-4.0 mm ²)	6-32 and 8-32	7.125" (181 mm)	Blue/Red	0.34 lb (0.15 kg)
11054	8-16 AWG Solid (10.0-1.5 mm ²); 10-18 AWG Stranded (6.0-1.0 mm ²)	6-32 and 8-32	7.125" (181 mm)	Blue/White	0.34 lb (0.15 kg)
11054GLW	8-16 AWG Solid (10.0-1.5 mm ²); 10-18 AWG Stranded (6.0-1.0 mm ²)	6-32 and 8-32	7.125" (181 mm)	Glow in the Dark	0.34 lb (0.15 kg)
11055	10-18 AWG Solid (6.0-1.0 mm ²); 12-20 AWG Stranded (4.0-0.50 mm ²)	6-32 and 8-32	7.125" (181 mm)	Blue/Yellow	0.34 lb (0.15 kg)
11057	20-30 AWG Solid (0.50-0.05 mm ²); 22-32 AWG Stranded (0.35-0.03 mm ²)	6-32 and 8-32	7.125" (181 mm)	Blue/Red	0.32 lb (0.15 kg)
K1412	NM-B Cable 12/2 and 14/2; 12-14 AWG Solid (4.0-2.5 mm ²); 14-16 AWG Stranded (2.5-1.5 mm ²)	6-32 and 8-32	7.75" (196.9 mm)	Yellow/White	0.41 lb (0.19 kg)
K1412CAN	NMD-90 Cable 12/2 and 14/2; 12-14 AWG Solid (4.0-2.5 mm ²); 14-16 AWG Stranded (2.5-1.5 mm ²)	6-32 and 8-32	7.75" (196.9 mm)	Yellow/White	0.41 lb (0.19 kg)

Klein-Kurve™ Wire Strippers/Crimpers/Cutters

Includes core features plus:

- Crimps insulated and non-insulated connectors
- Tip designed to grab, pull and bend the smallest of wires
- Reinforced head reduces flex
- Optimized for ideal leverage when stripping and crimping
- Precision shear-type cutting blades for easier cutting
- Do no use to cut steel wire



1019

Cat. No.	Strips and Cuts	Screw Shearing	Crimping Capacity	Overall Length	Handle Color	Weight
1009	10-20 AWG Solid (6.0-0.50 mm ²); 12-22 AWG Stranded (4.0-0.35 mm ²)	6-32 and 8-32	10-22 AWG (6.0-0.35 mm ²)	7.75" (196.9 mm)	Gray/Yellow	0.34 lb (0.15 kg)
NEW 1019	10-26 AWG Solid (6.0-0.14 mm ²); 12-28 AWG Stranded (4.0-0.10 mm ²)	6-32 and 8-32	10-22 AWG (6.0-0.35 mm ²) Insulated and Non-insulated Terminals; B-Connectors; Scotchlok® IDC Connectors	7.75" (196.9 mm)	Gray/Red	0.34 lb (0.15 kg)

See page 297 for additional information on warnings.



Wire Strippers/ Cutters

Textured handles provide a firm, comfortable grip

Spring loaded for self-opening action

Black-oxide finish resists corrosion

Easy-to-read wire gauge markings on both sides for stripping in either direction

Wire looping and bending holes

Precision-ground stripping holes for easy removal of insulation



Wire Strippers/Cutters

Includes core features plus:

- Narrow nose fits into tight places
- Cat. Nos. 1011 and 1011M strip six standard wire sizes without nicking wire
- Cat. No. 11048 strips two wires in a single motion
- Do not use for cutting steel wire or screws



DUAL-WIRE STRIPPER
11048



11045

Cat. No.	Strips and Cuts	Overall Length	Handle Color	Weight
11045	10-18 AWG Solid (6.0-1.0 mm ²)	6.25" (158.8 mm)	Yellow	0.27 lb (0.12 kg)
11046	16-26 AWG Stranded (1.5-0.14 mm ²)	6.25" (158.8 mm)	Red	0.27 lb (0.12 kg)
11047	22-30 AWG Solid (0.35-0.05 mm ²)	6.25" (158.8 mm)	Yellow	0.27 lb (0.12 kg)
11049	8-16 AWG Stranded (6 mm ² -1.0 mm ²)	6.25" (158.8 mm)	Red	0.27 lb (0.12 kg)
11048	10, 12, 14 AWG Solid (4.0 mm ² , 2.5 mm ² , 1.5 mm ²)	6.25" (158.8 mm)	Yellow	0.27 lb (0.12 kg)
1011	10-20 AWG Solid (6.0-0.50 mm ²); 12-22 AWG Stranded (4.0-0.35 mm ²)	6.125" (155.6 mm)	Blue	0.23 lb (0.10 kg)
1011M	0.15 to 4.0 mm ² Stranded Wire	6.125" (155.6 mm)	Blue	0.23 lb (0.10 kg)

Adjustable Wire Stripper/Cutters

- Cuts and strips solid and stranded wire
- Handy, light, compact tools for stripping insulation
- Adjustable dial for wire size adjustment prevents nicked wire (Cat. No. 74007)
- Adjustable slide stop with set screw for repeated stripping work (Cat. No. 1003, 1004)
- Convenient hole for looping or bending wire (Cat. No. 1003, 1004)
- Black-oxide finish with plastic-dipped handles



74007

Cat. No.	Strips and Cuts	Hold-Open Spring	Overall Length	Handle Color	Weight
74007	12-24 AWG Solid and Stranded (4.0-0.25 mm ²)	Yes	5.125" (130.2 mm)	Yellow	0.15 lb (0.07 kg)
1004	12-26 AWG Solid and Stranded (4.0- 0.14 mm ²)	Yes	5" (127.0 mm)	Yellow	0.18 lb (0.08 kg)
1003	12-26 AWG Solid and Stranded (4.0- 0.14 mm ²)	No	5" (127.0 mm)	Yellow	0.14 lb (0.06 kg)





Wire Strippers/Cutters

Katapult™ Adjustable Wire Stripper/Cutter

- Cuts and strips up to 22 AWG wire with ease
- Compound action wire stripping: grip and strip via single action squeezing motion
- Precision machined stripping holes easily remove jacket insulation without damaging the wire
- Removes up to 1" (24 mm) in length of the insulation layer (jacket layer) in a single step
- Tension loaded wire-grip gently holds the cable in place while retaining the cable geometry
- Additional cutting blades available

KATAPULT™



11063W

Cat. No.	Strips and Cuts	Hold-Open Spring	Overall Length	Handle Color	Weight
11063W	8-20 AWG Solid (10.0- 0.50 mm ²); 10-22 AWG Stranded (6.0- 0.35 mm ²)	Yes	6.594" (167.5 mm)	Blue/ Black	0.75 lb (0.34 kg)

Cat. No.	Application	Weight
Replacement Blades		
VDV110-046	RG6 Coaxial Cable	0.16 oz (4.5 g)
11082	10 AWG Max Wire (6.0 mm ²)	0.16 oz (4.5 g)
11073	8-22 AWG (10.0 -0.35 mm ²)	0.16 oz (4.5 g)
11074	16-26 AWG (1.5-0.14 mm ²)	0.16 oz (4.5 g)
Wire Stop/Gauge		
11081	Adjustable Wire Stop/Gauge	0.16 oz (4.5 g)

Self-Adjusting Wire Stripper/Cutter

- Stripping head adjusts to strip 10-20 AWG Solid, 12-22 Stranded and 12/2 and 14/2 Romex® wire
- Adjustable stopper to control the length of the core strip
- Convenient wire cutter in handle
- Tensioning thumb wheel allows for precise stripping of smaller gauge wires
- Grooved grips are designed for added comfort



11061

Cat. No.	Strips and Cuts	Hold-Open Spring	Overall Length	Handle Color	Weight
11061	10-20 AWG Solid (6.0- 0.50 mm ²); 12-22 AWG Stranded (4.0- 0.35 mm ²); 12/2 and 14/2 Romex® Wire	No	8.25" (209.6 mm)	Blue/Black	0.79 lb (0.36 kg)

Romex® is a registered trademark of Southwire Company.

NM Cable Ripper

- Easy-to-use cable ripper
- Slit the outer jacket of Romex® cable (all sizes) and other nonmetallic (type NM) sheathed cable
- Measure conductor wire gauge



74017

Cat. No.	Measures Wire Gage	Overall Length	Weight
74017	8-14 AWG (10.0-2.5 mm ²)	4" (101.6 mm)	1.3 oz (37 g)

Romex® is a registered trademark of Southwire Company.

See page 297 for additional information on warnings.



Combination Wire-Stripping and Crimping Tools

Multi-Purpose 6-in-1 Tool

- Easily cuts and strips 8-22 AWG Solid and 10-26 AWG Stranded wire
- Crimps 10-22 AWG insulated terminals
- Cleanly shears bolts
- Gauges wire sizes
- Measures stud sizes

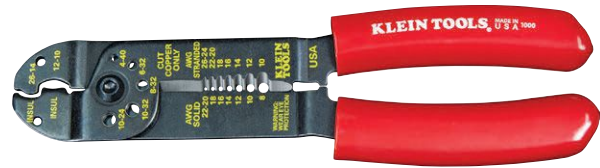

1000

Cat. No.	Strips and Cuts	Screw Shearing	Crimping Capacity	Overall Length	Handle Color	Weight
1000	8-22 AWG Solid (6.0 mm ² -0.34 mm ²), 10-26 AWG Stranded (4.0 mm ² -1.0 mm ²)	4-40, 6-32, 8-32, 10-24, 10-32	10-22 AWG (6.0- 0.35 mm ²)	7.75" (196.9 mm)	Red	0.44 lb (0.20 kg)

Multi-Purpose Electrician's Tool

- Cuts and strips 8-22 AWG Solid and 10-26 AWG Stranded wire
- Crimps 10-22 AWG insulated and non-insulated terminals
- Two wire cutters double the utility of this tool
- Cleanly shears bolts
- Pivot nut adjusts tension
- Wire-looping holes near tip

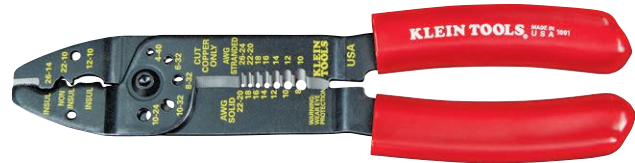

1001

Cat. No.	Strips and Cuts	Screw Shearing	Crimping Capacity	Overall Length	Handle Color	Weight
1001	8-22 AWG Solid (6.0 mm ² -0.34 mm ²), 10-26 AWG Stranded (4.0 mm ² -1.0 mm ²)	4-40, 6-32, 8-32, 10-24, 10-32	10-22 AWG (6.0- 0.35 mm ²)	8.5" (215.9 mm)	Red	0.47 lb (0.21 kg)

Multi-Purpose Long-Nose Tool

- Easily cuts and strips 10-20 AWG Solid and 12-22 Stranded wire
- Crimps 10-22 AWG insulated and non-insulated terminals and 7-8 mm ignition terminals
- Cleanly shears bolts
- Cutters and strippers are in front of the pivot for maximum ease-of-use in reaching into tight places
- Narrow, serrated pliers nose to pull, loop, and bend wire



1010

Cat. No.	Strips and Cuts	Screw Shearing	Crimping Capacity	Overall Length	Handle Color	Weight
1010	10-20 AWG Solid (6.0- 0.50 mm ²); 12-22 AWG Stranded (4.0- 0.35 mm ²)	4-40, 5-40, 6-32, 8-32, 10-32, 10-24	10-22 AWG (6.0- 0.35 mm ²)	8.25" (209.6 mm)	Blue	0.43 lb (0.20 kg)



Crimping Tools

Crimping/Cutting Tools

- Cut and crimp 10-22 AWG wire
- Tapered nose design for working in confined areas
- Specially hardened wire cutter in nose
- Hot-riveted joint for smooth action and no handle wobble

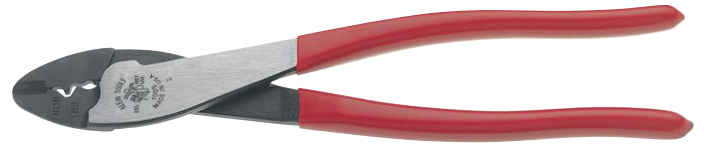

1005



Plastic-Dipped



JOURNEYMAN™
Dual-Material

See Insulated Tools section for insulated crimping/cutting tools.

Cat. No.	Crimps	Handle Color	Handle Finish	Overall Length	Weight
1005	10-22 AWG (6.0-0.35 mm ²) Insulated and Non-Insulated terminals	Red	Plastic-Dipped	9.75" (247.7 mm)	0.80 lb (0.36 kg)
1006	10-22 AWG (6.0-0.35 mm ²) Non-Insulated terminals	Black	Plastic-Dipped	9.75" (247.7 mm)	0.85 lb (0.39 kg)
Journeyman™ Series – Dual-material handles for better grip					
J1005	10-22 AWG (6.0-0.35 mm ²) Insulated and Non-Insulated terminals	Red/Black	Journeyman™	9.75" (247.7 mm)	0.84 lb (0.38 kg)

Large Crimp Tool-Compound-Action

- Ultra-comfortable hand grips for easy use
- All-in-one, integral crimp nest. No removable parts or rotating dies
- High-leverage handles and compound-action mechanism for superior mechanical advantage
- Adjustment screw allows user to control crimp depth



2006

Cat. No.	Handle Finish	Crimps	Overall Length	Handle Color	Weight
2006	Molded Grips	#6-4/0 AWG Battery Lugs and Terminals	19.5" (495.3 mm)	Red	3.8 lb (1.7 kg)

Ratcheting Crimpers - Insulated Terminals

- Cat. No. T1715 full cycle ratcheting crimper crimps insulated terminals in wire sizes 22-16 (front cavity), 16-14 (middle cavity), and 12-10 (rear cavity)
- Cat. No. T1710 compound-action tool crimps 10-22 AWG insulated terminals to meet or exceed MIL-SPEC pull-out tests and features a special locator to quickly position terminal to double crimp
- Built-in ratchet with safety release assures uniform crimps every time
- Compound lever-action of narrow span handles puts more crimping power into each squeeze



T1715



T1710

Cat. No.	Cable Size	Weight
T1715	22-16 AWG (0.35-1.5 mm ²); 16-14 AWG (1.5-2.5 mm ²); 12-10 AWG (4.0-6.0 mm ²)	1.1 lb (0.5 kg)
T1710	10-22 AWG (6.0-0.35 mm ²)	1.1 lb (0.5 kg)

See page 297 for additional information on warnings.



Cable and Bolt Cutters

Klein exceeds the highest standards to create superior cable and bolt cutters, offering greater cutting power, clean and precise cuts, as well as long life. Klein cable and bolt cutters are a cut above the rest.



For Professionals...
Since 1857™



Plastic-dipped handles for comfort and ease of identification

FORGED STEEL from Klein's US-made, proprietary blend

Cable Cutters

Hot-riveted joint ensures smooth action and no handle wobble

Through-hardened (not case-hardened) for longer-lasting cutting surfaces

Beveled jaw tips provide proper mating and shearing action, which protects leading jaw edges



High-Leverage Cable Cutters

Includes core cable cutter features plus:

- High-leverage design for exceptional cutting capability
- Precision, one-hand shearing action
- Cable-gripping shear-type jaws
- Perfect for working in confined spaces
- Fits in most tool pouches/belts



63050



Plastic-Dipped JOURNEYMAN™ Dual-Material

Refer to the insulated section for insulated cable cutters.

Cat. No.	Cutting Capacity	Handle Color	Handle Finish	Overall Length	Weight
63050	4/0 Aluminum, 2/0 Soft Copper, 100-Pair 24 AWG Communications Cable	Red	Plastic-Dipped	9.39" (238.5 mm)	0.90 lb (0.41 kg)
J63050	4/0 Aluminum, 2/0 Soft Copper, 100-Pair 24 AWG Communications Cable	Red/Black	Journeyman	9.563" (242.9 mm)	0.98 lb (0.44 kg)

Cable Cutters - Coaxial

Includes core cable cutter features plus:

- Cable-gripping jaws quickly score jacket and insulation, and easily cut through copper inner conductor
- Blades cleanly cut aluminum and copper coaxial cable without compression and frayed ends
- Forged body with heat-treated and precision-ground steel blade withstands frequent cutting
- Hot-riveted design requires no adjustment while maintaining a smooth, precise operation
- Compact, lightweight design fits perfectly in any professional's tool pouch
- When cutting drop wire with an inner steel conductor, we recommend our 2000 Series cutting pliers



63028



63030

Cat. No.	Cutting Capacity	Handle Color	Handle Finish	Overall Length	Weight
63028	3/4" (19.1 mm)	Yellow	Plastic-Dipped	8.25" (209.6 mm)	0.80 lb (0.36 kg)
63030	1" (25.4 mm)	Blue	Plastic-Dipped	8.25" (209.6 mm)	0.83 lb (0.38 kg)

See page 297 for additional information on warnings.



WARNING: Do NOT cut steel or ACSR.

Cable Cutters

Compact Cable Cutter

Includes core cable cutter features plus:

- Precise, one-hand shearing action cuts 24 AWG copper, aluminum multi-strand cable and wire, and 100-pair telephone cable
- Special shear angle cuts cleanly without compression to cable geometry for telecom cable work
- Heat-treated, high-carbon steel shearing edges for long life
- Forged body with 3/8" (10 mm) case-hardened rivet



63055

⚠ WARNING: Do NOT cut steel or ACSR.

Cat. No.	Cutting Capacity	Handle Color	Handle Finish	Overall Length	Weight
63055	24 AWG Copper, Aluminum Multi-Strand Cable and Wire, and 100-Pair Telephone Cable	Red	Plastic-Dipped	8" (203.2 mm)	0.65 lb (0.29 kg)

All-Purpose Shears and BX Cutter

Includes core cable cutter features plus:

- Handle cavity is designed to restore BX cable to original shape after cutting
- Stripping notch for added convenience
- High-leverage, shear-type design for one-hand operation
- Lightweight and compact



1104

⚠ WARNING: Do NOT cut steel or ACSR.

Cat. No.	Cutting Capacity	Handle Color	Handle Finish	Overall Length	Weight
1104	Cuts BX Cable, Sheet Metal, Steel Strapping and Bundling Wire	Red	Plastic Dipped	7.625" (193.7 mm)	0.60 lb (0.27 kg)

Heavy-Duty Cable Shears

- Cuts ACSR, steel, and most hardened wire
- Heavy-duty, tempered steel blades
- Blades grip cable and cut easily at center of jaws
- Lock keeps handles closed for easy storage
- Comfortable, plastic-coated handles for steady grip
- Hardened steel, precision cutting blades for long service life
- Unique triangular jaws cleanly cut cable without compression or frayed ends



63016

Cat. No.	Cutting Capacity	Handle Color	Handle Finish	Overall Length	Weight
63016	Up to 1/4" (6.4 mm) Copper and Mild Steel Strands, up to 3/16" (4.8 mm) Aircraft Cable, Wire Rope, Aluminum and Copper Rods, up to 5/32" (4 mm) for Steel and Iron Rods	Blue	Plastic-Dipped	7.5" (190.5 mm)	0.65 lb (0.29 kg)

Multi-Cable Cutter

- Hardened steel precision-ground cutting blades for long life
- Copper curved cutter cleanly cuts round copper cable without compression or frayed ends
- Double-dipped grips for comfort
- Coil spring provides fast self-opening action
- Holes for looping and bending wire
- Convenient lock for storage also prevents accidental locking and loosening over time

KLEIN-KURVE™



63020

Cat. No.	Cutting Capacity	Screw Shearing	Handle Color	Overall Length	Weight
63020	Up to 12 AWG Solid and Stranded Copper Wire, Up to 0.032" (.081 mm) Diameter Stainless Steel, Up to 1/2" (12.7 mm) Multi-conductor Cable, Coaxial Cable RG-6 Quad, RG-59 and RG-62	6-32 & 8-32	Red	7" (177.8 mm)	0.44 lb (0.20 kg)



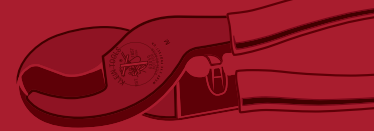

Cable Cutters

Utility Cable and Rope Cutters

- Forged steel with black-oxide finish for long life
- Shear-type hook jaws grab and hold cable while shear-cutting action makes clean cuts
- Beveled tips for positive mating
- Hinge bolt with pin-set nut for proper blade tension
- Cat. No. 63035SC cuts wire up to 9/32" (7 mm) and Stoffel® container seals
- Cat. No. 63035 is not designed to cut steel or ACSR



Cat. No.	Cutting Capacity	Handle Color	Overall Length	Weight
63035	MCM Cable 350 Copper, 350 Aluminum	Red	16.25" (412.8 mm)	1.7 lb (0.8 kg)
63035SC	9/32" (7.1 mm) Wire Rope and Cables	Red	18" (457.2 mm)	2.0 lb (0.9 kg)

Stoffel® is a registered trademark of Stoffel Seals Corporation.

Standard and Communication Cable Cutters

- Lightweight, yet efficient shear-type cable cutters
- Replaceable hook-jaw blades grab and hold cable while shear-cutting action makes clean cuts
- Exceptionally strong fiberglass handles with heavy vinyl grips for comfort and slip resistance
- Heavy-duty pins in head serve as blade-stops
- Jaws are forged tool steel with black-oxide finish for long life
- Beveled tips assure positive mating, and hinge on a rugged bolt with a pin-set nut to maintain proper blade tension
- Makes a clean, even cut for ease in fitting lugs and terminals
- Cat. No. 63041TH includes rubber sleeves
- Cat. No. 63047 cuts lead or rubber-covered communications cable



WARNING: Do NOT cut steel or ACSR.

Cat. No.	Soft Cable Maximum Capacity	MCM Cable Maximum Capacity	Replacement Blade	Overall Length	Weight
63041	1-3/8" (34.9 mm) Diameter	MCM 500 Copper, 750 Aluminum	63081	25.5" (647.7 mm)	5.3 lb (2.4 kg)
63041TH	1-3/8" (34.9 mm) Diameter	MCM 500 Copper, 750 Aluminum	63081	25.5" (647.7 mm)	5.3 lb (2.4 kg)
63045	1-3/4" (44.5 mm) Diameter	1000 Copper, 1200 Aluminum	63090	32" (812.8 mm)	8.0 lb (3.6 kg)
63047	Up to 2-1/4" (57.2 mm) Diameter	900-Pair Soft Copper and Aluminum	63110	37" (939.8 mm)	8.6 lb (3.9 kg)

See page 297 for additional information on warnings.



Cable Cutters

Ratcheting Cable Cutters

- Reduced hand force for easier cutting
- Patented two-step ratchet mechanism requires fewer strokes per cut
- Quick release lever opens blades easily in every cutting position to allow removal of the cable before completion of cut
- Hardened steel cutting blades for lasting strength and sharpness
- Locking lever keeps handles closed for easy transport; fits in a toolbox or bag

⚠WARNING: Do NOT cut steel or ACSR.



63601

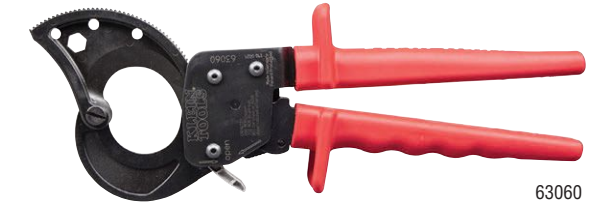

63060

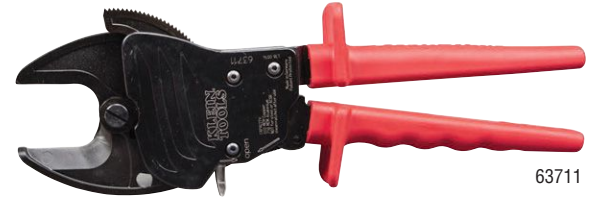

63711



63750

Replacement parts available

(blades, handles, springs, pawl sets and release plates).

Go to www.kleintools.com or call 800-553-4676 for a full listing of replacement parts.

Cat. No.	MCM Maximum Cable Capacity (Aluminum)	MCM Maximum Cable Capacity (Copper)	MCM Maximum Cable Capacity (Communication Cable)	Overall Length	Handle Color	Weight
63060	750 MCM (380 mm ²)	600 MCM (300 mm ²)	1-1/8" (28.6 mm)	10.25" (260.4 mm)	Red	1.3 lb (0.6 kg)
63711	750 MCM (400 mm ²)	600 MCM (300 mm ²)	1-1/8" (28.6 mm)	11.5" (292.1 mm)	Red	2.0 lb (0.9 kg)
63750	1000 MCM (500 mm ²), Frequent Use: 750 MCM (400 mm ²)	1000 MCM (500 mm ²), Frequent Use: 750 MCM (400 mm ²)	2-1/16" (52.4 mm)	12.125" (308 mm)	Red	1.8 lb (0.8 kg)
63601	1000 MCM (500 mm ²)	600 MCM (300 mm ²)	2-1/16" (52.4 mm)	10.25" (260.4 mm)	Red	2.7 lb (1.2 kg)

ACSR Ratcheting Cable Cutter

- High-leverage ratcheting mechanism for easier cutting
- Quick-release lever opens blades easily in every cutting position. (Allows removal of the cable before completion of cut)
- Hardened steel cutting blades for long lasting strength and sharpness
- Tools can be locked when not in use
- Cat. No. 63800ACSR features cutting inserts with screws

Replacement parts available

(blades, handles, springs, pawl sets and release plates).

Go to www.kleintools.com or call 800-553-4676 for a full listing of replacement parts.

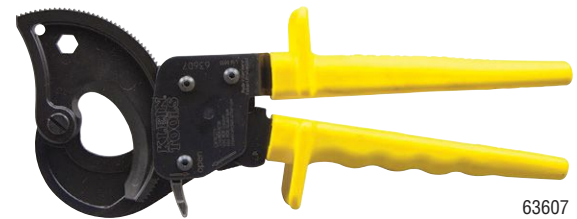

63607

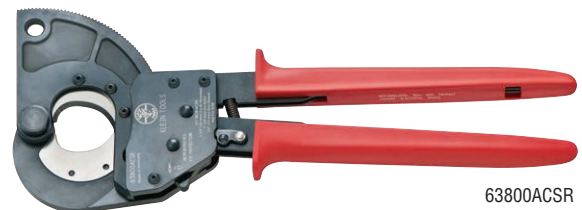

63800ACSR

Cat. No.	MCM Maximum Cable Capacity (ACSR)	MCM Maximum Cable Capacity (Aluminum)	MCM Maximum Cable Capacity (Copper)	MCM Maximum Cable Capacity (Guy Strand)	Handle Color	Overall Length	Weight
63607	336 MCM (170 mm ²)	600 MCM (300 mm ²)	400 MCM (185 mm ²)	—	Yellow	10.25" (260.4 mm)	1.5 lb (0.7 kg)
63800ACSR	477 MCM (273 mm ²)	1-1/4" (31.8 mm)	1" (25.4 mm)	1/2" (12.7 mm)	Red	13.75" (349.3 mm)	3.2 lb (1.5 kg)



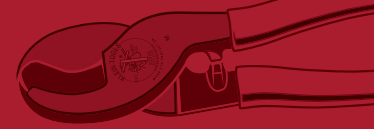

Cable Cutters

Ratcheting ACSR Cable Cutter - Heavy-Duty



- Ratchet-action design provides maximum leverage with minimum effort for heavy-duty use
- Forged, heat-treated, shear-type blades, plus 24" (610 mm) long fiberglass handles with heavy duty grips for comfort and slip resistance
- Blade-advance knob for fast rotation of the blade to engage the cable or other material being cut
- Quick-release mechanism allows for removal of the cable or rod before completion of the cut, if desired
- Not designed for cutting EHS guy strand or reinforcement rod
- Cuts steel and ACSR

63700

Cat. No.	Soft Cable Maximum Capacity	Steel Cable Maximum Capacity	Handle Color	Overall Length	Weight
63700	2-1/4" (57.2 mm) Diameter, 750 MCM (1-3/8" [34.9 mm]) Diameter, Copper or Aluminum	1-1/4" (31.8 mm) Diameter ACSR, ACAR, 7/16" (11.1 mm) Diameter Common Guy Strand, 5/8" (15.9 mm) Diameter Steel Wire Rope, 1/2" (12.7 mm) Diameter Steel Rod (C.R.S. SOFT)	Yellow	28" (711.2 mm)	14.0 lb (6.4 kg)

Cable Tools

Cable Benders

- Forged, one-piece steel construction for exceptional strength and durability
- Head is angled 22° for ease in bending cable in tight, hard-to-access places
- Corrosion-resistant, black-oxide finish with heavy-duty double-dipped plastic handle
- It is recommended that two benders be used for easier bends



50400

Cat. No.	Tool Opening	Maximum Cable Capacity	Overall Length	Weight
50400	7/8" (22.2 mm)	350 MCM	12" (304.8 mm)	0.90 lb (0.41 kg)
50402	1-1/64" (25.8 mm)	500 MCM	14.5" (368.3 mm)	1.6 lb (0.7 kg)

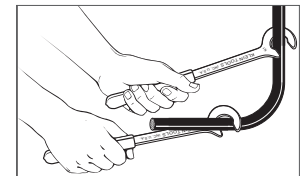

2 benders are recommended for easier bends



Bolt Cutters

Heavy-Duty Ratcheting Bolt Cutter

- Spring-loaded cable retention hook snaps onto the cable in one hands-free motion and keeps strands between cutting blades
- Long handles provide leverage when cutting
- Lockplate reinforcement prevents jaw bolts from loosening or turning, keeps jaws in correct alignment
- Up to HRC Rockwell C31, Rockwell C42



63RBCHD

EASY AS



OPEN

movable handle to full extension to open cutting jaws



SNAP

cable between cutting jaws



CUT

cable using ratcheting handle

Cat. No.	Cutting Capacity	Overall Length	Weight
63RBCHD	5/8" (15.9 mm) Ground Rod, 1/2" (12.7 mm) Rebar, 7/16" (11.1 mm) Grade 8 Bolts, 1/2" (12.7 mm) Grade 5 Bolts, 1/2" (12.7 mm) Utility-Grade Guy Strand, 3/8" (9.5 mm) EHS	31" (787.4 mm)	10.0 lb (4.5 kg)

Bolt Cutters - Steel and Fiberglass Handle

- All-purpose, center-cut jaws
- Forged, alloy tool steel jaws are precision ground for sure, efficient cutting and long life
- Lock plate reinforcement prevents jaw bolts from loosening or turning, keeping jaws in correct alignment
- NOT for cutting cable



63314

63118

Cat. No.	Soft & Medium Cutting Max Capacity	Hard Material Cutting Max Capacity	Handle Material	Replacement Blade	Overall Length	Weight
63314	5/16" (7.9 mm)	3/16" (4.8 mm)	Steel	63814	14" (355.6 mm)	3.2 lb (1.4 kg)
63318	3/8" (9.5 mm)	1/4" (6.4 mm)	Steel	63818	18" (457.2 mm)	3.6 lb (1.6 kg)
63324	7/16" (11.1 mm)	5/16" (7.9 mm)	Steel	63824	24" (609.6 mm)	6.3 lb (2.9 kg)
63330	1/2" (12.7 mm)	3/8" (9.5 mm)	Steel	63831	30" (762.0 mm)	10.2 lb (4.6 kg)
63336	9/16" (14.3 mm)	7/16" (11.1 mm)	Steel	63836	36" (914.4 mm)	14.3 lb (6.5 kg)
63342	11/16" (17.5 mm)	1/2" (12.7 mm)	Steel	63842	42" (106.7 cm)	19.2 lb (8.7 kg)
63118	3/8" (9.5 mm)	1/4" (6.4 mm)	Fiberglass	63918	18.25" (463.6 mm)	3.7 lb (1.7 kg)
63124	7/16" (11.1 mm)	5/16" (7.9 mm)	Fiberglass	63924	24.5" (622.3 mm)	6.1 lb (2.8 kg)
63130	1/2" (12.7 mm)	3/8" (9.5 mm)	Fiberglass	63930	30.5" (774.7 mm)	9.5 lb (4.3 kg)
63136	1/2" (12.7 mm)	3/8" (9.5 mm)	Fiberglass		36.5" (927.1 mm)	13.0 lb (5.9 kg)

* Up to Brinell 300, Rockwell C31., ** Up to Brinell 400, Rockwell C42.





Insulated Tools

Klein insulated tools combine excellent functionality along with reduction of risk of injury where a tool might make contact with an energized source with voltage up to 1000 volts.

 **1000 V**

For Professionals...
Since 1857™

Electrician's Insulated Tools (EINS)

 **1000 V**



Durable, three component molded insulation provides protection against electric shock

Multi-color, sleek design with small thumb guards for ease of handling and storage

A flame retardant, impact-resistant, multi-color outer coating



Induction hardened cutting knives for long life

Hot-riveted joint ensures smooth action and no handle wobble



MADE IN USA

Thick, exceptionally tough, high-dielectric white inner coating is bonded to the tool

FORGED STEEL
from Klein's US-made, proprietary blend

Insulated Tools (INS)

 **1000 V**

Integral guards help prevent hand contact with conductive parts



A flame retardant, impact-resistant, bright orange outer coating

All Klein insulated tools comply with ASTM F-1505 and IEC 60900 standards for insulated tools and are clearly marked with the official international 1000-volt rating symbol. Not all tools with plastic coatings or plastic handles provide protection against electrical shock. Only use those tools that are marked with the official international 1000-volt rating symbol, as shown, if there is any chance that the tool will make contact with an energized source.

Klein's Classic Lineman's insulated tools feature large, bright orange handles making the tool comfortable to use all day and easy to identify in the field. The Electrician's line of insulated tools (EINS) provides a multi-color, sleeker design than the Classic Lineman's insulated tools. EINS tools have passed VDE third party testing certification to the IEC 60900 standard. This line of tools provides the everyday protection the electrician needs in a compact, lightweight design.

Product numbers with the INS and EINS suffix contain these warnings below and must be understood.

▲WARNING: Only use tools that are marked with the official international 1000-volt rating symbol shown below, if there is any chance that the tools will make contact with an energized source.

 **1000 V**

▲WARNING: Wear approved eye protection. Always inspect your tools before use. Do not use if orange coating cracks, breaks or becomes damaged. Destroy tool if white layer shows through orange layer.

▲WARNING: Do NOT touch uninsulated portion of the tool or any conductive object when either might contact an energized source.

▲WARNING: Whenever possible, always de-energize lines and equipment prior to working on or around them. Klein insulated tools are designed only to reduce the chance of injury where the tool may make contact with an energized source.

▲WARNING: Because moisture, films, or other surface contaminants are conductive, Klein insulated tools must be kept clean, dry, and free of any surface contaminants.





Insulated Pliers

Insulated High-Leverage Side-Cutting Pliers

Includes core insulated features plus:

- High-leverage design provides 46% greater cutting and gripping power than other plier designs
- Streamlined design with sure-gripping, cross-hatched knurled jaws
- Crimping die behind hinge for superior leverage crimping non-insulated connectors, lugs and terminals (Cat. No. D213-9NE-CR-INS)



213-9NE-EINS



CRIMPING FEATURE
D213-9NE-CR-INS



EINS – Orange/Gray



INS – Orange

Cat. No.	Overall Length	Jaw Length	Jaw Width	Jaw Thickness	Knife Length	Handle Color	Handle Finish	Weight
2138NEEINS	8.813" (223.9 mm)	1.438" (36.5 mm)	1.109" (28.2 mm)	5/8" (15.9 mm)	0.75" (19.1 mm)	Orange/Gray	3-Layer	1.0 lb (0.5 kg)
2139NEEINS	9.625" (244.5 mm)	1.594" (40.5 mm)	1.313" (33.4 mm)	5/8" (15.9 mm)	0.781" (19.8 mm)	Orange/Gray	3-Layer	1.3 lb (0.6 kg)
D213-9NE-INS	9.625" (244.5 mm)	1.594" (40.5 mm)	1.313" (33.4 mm)	5/8" (15.9 mm)	0.781" (19.8 mm)	Orange	2-Layer	1.3 lb (0.6 kg)
D213-9NE-CR-INS	9.625" (244.5 mm)	1.594" (40.5 mm)	1.313" (33.4 mm)	5/8" (15.9 mm)	0.781" (19.8 mm)	Orange	2-Layer	1.3 lb (0.6 kg)
Pliers with heavy-duty cutting knives design to cut ACSR, screws, nails and most hardened wire								
20009NEEINS	9.625" (244.5 mm)	1.594" (40.5 mm)	1.313" (33.4 mm)	5/8" (15.9 mm)	0.781" (19.8 mm)	Orange/Gray	3-Layer	1.3 lb (0.6 kg)
D2000-9NE-INS	9.625" (244.5 mm)	1.594" (40.5 mm)	1.313" (33.4 mm)	5/8" (15.9 mm)	0.781" (19.8 mm)	Orange	2-Layer	1.3 lb (0.6 kg)

Insulated High-Leverage Diagonal Cutting Pliers

Includes core insulated features plus:

- High-leverage design. Rivet is closer to the cutting edge for 36% greater cutting power than other pliers designs
- 13° angled head for easier work in confined spaces (Cat. Nos. 2000-48-EINS, D248-8-INS, and D2000-48-INS)



2000-28-EINS



EINS – Orange/Gray



INS – Orange

Cat. No.	Overall Length	Jaw Length	Jaw Width	Jaw Thickness	Cutting Knives	Handle Color	Handle Finish	Weight
D228-8-INS	8.25" (209.6 mm)	0.813" (20.7 mm)	1.188" (30.2 mm)	13/16" (20.6 mm)	Standard	Orange	2-Layer	0.70 lb (0.32 kg)
D248-8-INS	8.25" (209.6 mm)	0.813" (20.7 mm)	1.188" (30.2 mm)	13/16" (20.6 mm)	Standard	Orange	2-Layer	0.70 lb (0.32 kg)
Pliers with heavy-duty cutting knives design to cut ACSR, screws, nails and most hardened wire								
200028EINS	8.25" (209.6 mm)	0.813" (20.7 mm)	1.188" (30.2 mm)	13/16" (20.6 mm)	Standard	Orange/Gray	3-Layer	0.70 lb (0.32 kg)
D2000-28-INS	8.25" (209.6 mm)	0.813" (20.7 mm)	1.188" (30.2 mm)	13/16" (20.6 mm)	Standard	Orange	2-Layer	0.70 lb (0.32 kg)
200048EINS	8.25" (209.6 mm)	0.813" (20.7 mm)	1.188" (30.2 mm)	13/16" (20.6 mm)	Standard	Orange/Gray	3-Layer	0.70 lb (0.32 kg)
D2000-48-INS	8.25" (209.6 mm)	0.813" (20.7 mm)	1.188" (30.2 mm)	13/16" (20.6 mm)	Standard	Orange	2-Layer	0.70 lb (0.32 kg)

Insulated Heavy-Duty Diagonal-Cutting Pliers - Tapered Nose

Includes core insulated features plus:

- Heavy-duty tapered nose design for working in confined areas
- One-inch deep jaws easily reach into confined spaces



D220-7-INS

Cat. No.	Overall Length	Jaw Length	Jaw Width	Jaw Thickness	Cutting Knives	Handle Color	Handle Finish	Weight
D220-7-INS	7.875" (200 mm)	1" (25.4 mm)	0.969" (24.6 mm)	1" (25.4 mm)	Standard	Orange	2-Layer	0.70 lb (0.32 kg)

See page 297 for additional information on warnings.



Insulated Pliers

Insulated Long-Nose Pliers - Side-Cutting

Includes core insulated features plus:

- Knurled jaws for sure wrapping and looping
- Curved handles provide greater tool control (Cat. Nos. 203-6-EINS, D203-6-INS, 203-7-EINS, and D203-7-INS)
- Extended handles provide added reach and leverage (Cat. Nos. D203-8-INS and D203-8N-INS)
- Heavier design for easier, more comfortable cutting and extended handle for added reach and leverage (Cat. No. 203-8-EINS)
- Skinning hole for No. 12 AWG wire (Cat. No. D203-8N-INS)



203-8-EINS

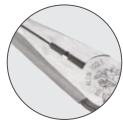

12 AWG SKINNING HOLE
D203-8N-INS



EINS – Orange/Gray INS – Orange

Cat. No.	Overall Length	Jaw Length	Jaw Width	Jaw Thickness	Point Diameter	Knife Length	Handle Color	Handle Finish	Weight
2036EINS	6.875" (174.6 mm)	1.938" (49.2 mm)	0.688" (17.5 mm)	3/8" (9.5 mm)	.094" (2.4 mm)	0.5" (12.7 mm)	Orange/Gray	3-Layer	0.30 lb (0.14 kg)
D203-6-INS	6.875" (174.6 mm)	1.938" (49.2 mm)	0.688" (17.5 mm)	3/8" (9.5 mm)	.094" (2.4 mm)	0.5" (12.7 mm)	Orange	2-Layer	0.30 lb (0.14 kg)
2037EINS	7.375" (187.3 mm)	2.438" (61.9 mm)	0.688" (17.5 mm)	3/8" (9.5 mm)	.094" (2.4 mm)	0.5" (12.7 mm)	Orange/Gray	3-Layer	0.30 lb (0.14 kg)
D203-7-INS	7.375" (187.3 mm)	2.438" (61.9 mm)	0.688" (17.5 mm)	3/8" (9.5 mm)	.094" (2.4 mm)	0.5" (12.7 mm)	Orange	2-Layer	0.30 lb (0.14 kg)
2038EINS	8.875" (225.4 mm)	2.313" (58.8 mm)	1" (25.4 mm)	1/2" (12.7 mm)	0.125" (3.2 mm)	0.625" (15.9 mm)	Orange/Gray	3-Layer	0.70 lb (0.32 kg)
D203-8-INS	8.875" (225.4 mm)	2.313" (58.8 mm)	1" (25.4 mm)	1/2" (12.7 mm)	0.125" (3.2 mm)	0.625" (15.9 mm)	Orange	2-Layer	0.70 lb (0.32 kg)
D203-8N-INS	8.875" (225.4 mm)	2.313" (58.8 mm)	1" (25.4 mm)	1/2" (12.7 mm)	0.125" (3.2 mm)	0.625" (15.9 mm)	Orange	2-Layer	0.70 lb (0.32 kg)

Insulated Combination Pliers

Includes core insulated features plus:

- Crimping die behind hinge for superior leverage crimping non-insulated connectors, lugs and terminals
- Toothed pipe-grip for greater power



12098-EINS



EINS – Orange/Gray INS – Orange

Cat. No.	Overall Length	Jaw Length	Jaw Width	Jaw Thickness	Knife Length	Handle Color	Handle Finish	Weight
12098EINS	8.875" (225.4 mm)	1.781" (45.2 mm)	1.031" (26.2 mm)	17/32" (13.5 mm)	0.75" (19.1 mm)	Orange/Gray	3-Layer	1.0 lb (0.5 kg)
12098-INS	8.875" (225.4 mm)	1.781" (45.2 mm)	1.031" (26.2 mm)	17/32" (13.5 mm)	0.75" (19.1 mm)	Orange	2-Layer	1.0 lb (0.5 kg)

Insulated Pump Pliers

Includes core insulated features plus:

- Secure tongue and groove design for non-slip grip - even with heavy pressure



502-10-EINS



EINS – Orange/Gray INS – Orange

Cat. No.	Overall Length	Jaw Capacity	Handle Color	Handle Finish	Weight
502-10-EINS	10.25" (260.4 mm)	1-3/4" (44.5 mm)	Orange/Gray	3-Layer	1.0 lb (0.5 kg)
D502-10-INS	10.25" (260.4 mm)	1-3/4" (44.5 mm)	Orange	2-Layer	1.0 lb (0.5 kg)





Insulated Crimping/Cutting/Stripping Tools

Insulated Crimping/Cutting Tool

Includes core insulated features plus:

- Tapered nose design for working in confined spaces
- Crimping dies marked for insulated and non-insulated solderless terminals and connectors
- Accommodates wire from No. 10 to 22 AWG
- Wire cutter in nose



1005-INS

Cat. No.	Crimps	Overall Length	Handle Color	Handle Finish	Weight
1005-INS	10-22 AWG	9.75" (247.7 mm)	Orange	2-Layer	1.0 lb (0.5 kg)

Insulated Wire Stripper/Cutters

Includes core insulated features plus:

- Cuts, strips, loops and gauges wire
- Spring-loaded for self-opening
- Compact, lightweight wire-stripping and cutting tool
- Narrow serrated nose fits into tight places for easy bending, shaping and pulling of wire
- Cat. Nos. 11054-EINS and 11055-INS cleanly shear 6-32 and 8-32 screws
- Do not use for cutting steel wire or bolts
- Hardened spring steel with precision-ground stripping holes for easy removal of insulation



EINS - Orange/Gray



INS - Orange

11054-EINS

Cat. No.	Strips and Cuts	Screw Shearing	Overall Length	Handle Color	Weight
Straight Handle					
11045-INS	10, 12, 14, 16, 18 Solid AWG (4.0 mm ² , 2.5 mm ² , 1.5 mm ² , 1.0 mm ² , 0.75 mm ²)	—	7" (177.8 mm)	Orange	0.60 lb (0.27 kg)
11049-INS	8, 10, 12, 14, 16 Stranded AWG (6.0 mm ² , 4.0 mm ² , 2.5 mm ² , 1.5 mm ² , 1.0 mm ²)	—	7" (177.8 mm)	Orange	0.60 lb (0.27 kg)
Klein-Kurve™ comfort grip handles					
11054EINS	8-16 AWG Solid (8.4 mm ² -1.3 mm ²), 10-18 AWG Stranded (5.3 mm ² -0.82 mm ²)	6-32 and 8-32	8" (203.2 mm)	Orange/Gray	0.50 lb (0.23 kg)
11055-INS	10, 12, 14, 16, 18 AWG Solid (4.0 mm ² , 2.5 mm ² , 1.5 mm ² , 1.0 mm ² , 0.75 mm ²) 12, 14, 16, 18, 20 AWG Stranded (2.5 mm ² , 1.5 mm ² , 1.0 mm ² , 0.82 mm ² , 0.50 mm ²)	6-32 and 8-32	8" (203.2 mm)	Orange	0.75 lb (0.34 kg)

Insulated High-Leverage Cable Cutter

Includes core insulated features plus:

- High-leverage design for exceptional cutting capability
- Cable-gripping shear-type jaws
- Precision, one-hand shearing action
- Perfect for working in confined spaces
- Do NOT use to cut steel or ACSR



EINS - Orange/Gray



INS - Orange

63050-EINS

Cat. No.	Cutting Capacity	Overall Length	Handle Color	Weight
63050-EINS	4/0 Aluminum, 2/0 Soft Copper, 100-Pair 24 AWG Communications Cable	9.625" (244.5 mm)	Orange/Black	1.0 lb (0.5 kg)
63050-INS	4/0 Aluminum, 2/0 Soft Copper, 100-Pair 24 AWG Communications Cable	9.625" (244.5 mm)	Orange	1.0 lb (0.5 kg)

Insulated Lineman's Skinning Knife

Includes core insulated features plus:

- Large molded, comfort grip handle with measuring marks to help measure stripping length of wire
- Tough, tempered steel blade provides maximum sharpness and durability to withstand frequent cable scoring
- Notch on back of blade for scraping or removing insulation



1571-INS

Cat. No.	Special Features	Blade Length	Overall Length	Blade Material	Handle Color	Weight
1571INS	Measuring Marks on Handle	2.375" (60.3 mm)	8.75" (222.3 mm)	1095 Steel	Orange	5.6 oz (159 g)

See page 297 for additional information on warnings.



Insulated Screwdrivers and Nut Drivers



Klein insulated tools meet or exceed the IEC 60900 and ASTM F1505 standards, for insulated tools, and are clearly marked with the official 1000-volt rating symbol

Thick, exceptionally tough, high-dielectric white inner coating is bonded to the tool

Bright orange outer coating is flame and impact resistant



FORGED STEEL

from Klein's US-made, proprietary blend

Durable, two layer, molded insulation

Cushion-Grip handles for greater torque and comfort

Tip-Ident® quickly identifies nut driver size



⚠WARNING: Only use tools that are marked with the official international 1000-volt rating symbol shown below, if there is any chance that the tools will make contact with an energized source.



⚠WARNING: Wear approved eye protection. Always inspect your tools before use. Do not use if orange coating cracks, breaks or becomes damaged. Destroy tool if white layer shows through orange layer.

Product numbers with the INS suffix contain these warnings and must be understood.

⚠WARNING: Do NOT touch uninsulated portion of the tool or any conductive object when either might contact an energized source.

⚠WARNING: Whenever possible, always de-energize lines and equipment prior to working on or around them. Klein insulated tools are designed only to reduce the chance of injury where the tool may make contact with an energized source.

⚠WARNING: Because moisture, films, or other surface contaminants are conductive, Klein insulated tools must be kept clean, dry, and free of any surface contaminants.

Insulated Screwdrivers - Round-Shank

Includes core insulated screwdriver features plus:

- Klein's profilated Phillips provides a more consistent geometric symmetry than conventional Phillips screwdrivers
- Square-Recess tips are perfect for electrical, telephone and work in recessed holes and other tight spaces



603-7-INS



Cat. No.	Tip Type	Shank Type	Shank Length	Overall Length	Weight
6334INS	#1 Phillips	Round	4" (101.6 mm)	7.75" (196.9 mm)	2.1 oz (60 g)
603-4-INS	#2 Phillips	Round	4" (101.6 mm)	8.313" (211.2 mm)	3.2 oz (91 g)
6037INS	#2 Phillips	Round	7" (177.8 mm)	11.313" (287.4 mm)	4.0 oz (113 g)
6337INS	#3 Phillips	Round	7" (177.8 mm)	12.375" (314.3 mm)	6.4 oz (181 g)
607-3-INS	3/32" (2.4 mm) Cabinet Tip	Round	3" (76.2 mm)	6.75" (171.5 mm)	1.9 oz (54 g)
612-4-INS	1/8" (3.2 mm) Cabinet Tip	Round	4" (101.6 mm)	7.75" (196.9 mm)	2.1 oz (60 g)
601-4-INS	3/16" (4.8 mm) Cabinet Tip	Round	4" (101.6 mm)	7.75" (196.9 mm)	2.1 oz (60 g)
601-7-INS	3/16" (4.8 mm) Cabinet Tip	Round	7" (177.8 mm)	10.75" (273.1 mm)	2.7 oz (77 g)
602-4-INS	1/4" (6.4 mm) Cabinet Tip	Round	4" (101.6 mm)	8.313" (211.2 mm)	3.2 oz (91 g)
605-7-INS	1/4" (6.4 mm) Cabinet Tip	Round	7" (177.8 mm)	11.313" (287.4 mm)	4.0 oz (113 g)
602-7-INS	5/16" (7.9 mm) Cabinet Tip	Round	7" (177.8 mm)	12.375" (314.3 mm)	6.4 oz (181 g)
602-8-INS	3/8" (9.5 mm) Cabinet Tip	Round	8" (203.2 mm)	13.375" (339.7 mm)	8 oz (227 g)
661-4-INS	#1 Square	Round	4" (101.6 mm)	8.313" (211.2 mm)	3.2 oz (91 g)
661-7-INS	#1 Square	Round	7" (177.8 mm)	11.313" (287.4 mm)	3.2 oz (91 g)
662-4-INS	#2 Square	Round	4" (101.6 mm)	8.313" (211.2 mm)	3.2 oz (91 g)
662-7-INS	#2 Square	Round	7" (177.8 mm)	11.313" (287.4 mm)	3.2 oz (91 g)





Insulated Screwdriver Sets

2-Piece Insulated 4" (102 mm) Screwdriver Set - Round Shanks

Includes core insulated screwdriver features plus:

- Includes one 1/4" (6 mm) cabinet-tip and one #2 Phillips



33532-INS

Cat. No.	Set Contains	Weight		
33532-INS		0.60 lb (0.27 kg)		
Cat. No.	Tip Type	Shank Type	Shank Length	Overall Length
602-4-INS	1/4" (6.4 mm) Cabinet Tip	Round	4" (101.6 mm)	8.313" (211.2 mm)
603-4-INS	#2 Phillips	Round	4" (101.6 mm)	8.313" (211.2 mm)

9-Piece Insulated Cushion-Grip Screwdriver Set

Includes core insulated screwdriver features plus:

- Features three sizes of each tip style: cabinet, keystone, and Phillips
- Highly durable, black nylon case features: nylon-zipper closure, polypropylene handles, custom-fitted tool pockets; extra pocket is provided for storage of papers or other items
- Overall dimensions: 15-1/2" W x 11" D x 2-1/2" H (394 mm x 279 mm x 64 mm)
- Replacement case (Cat. No. 33538) available



33528

Cat. No.	Set Contains	Weight		
33528		5.4 lb (2.5 kg)		
Cat. No.	Tip Type	Shank Type	Shank Length	Overall Length
601-4-INS	3/16" (4.8 mm) Cabinet Tip	Round	4" (101.6 mm)	7.75" (196.9 mm)
601-7-INS	3/16" (4.8 mm) Cabinet Tip	Round	7" (177.8 mm)	10.75" (273.1 mm)
612-4-INS	1/8" (3.2 mm) Cabinet Tip	Round	4" (101.6 mm)	7.75" (196.9 mm)
602-4-INS	1/4" (6.4 mm) Cabinet Tip	Round	4" (101.6 mm)	8.313" (211.2 mm)
602-7-INS	5/16" (7.9 mm) Cabinet Tip	Round	7" (177.8 mm)	12.375" (314.3 mm)
602-8-INS	3/8" (9.5 mm) Cabinet Tip	Round	8" (203.2 mm)	13.375" (339.7 mm)
6334INS	#1 Phillips	Round	4" (101.6 mm)	7.75" (196.9 mm)
603-4-INS	#2 Phillips	Round	4" (101.6 mm)	8.313" (211.2 mm)
6337INS	#3 Phillips	Round	7" (177.8 mm)	12.375" (314.3 mm)
33538	Heavy-Duty Polyester Case			

See page 297 for additional information on warnings.



Insulated Nut Drivers

6" (152 mm) Insulated Hollow-Shaft Nut Drivers

Includes core insulated nut driver features plus:

- Slimmer molded insulation with increased durability



646-5/8-INS



Cat. No.	Nut Driver Sizes	Shaft Length	Color Code	Overall Length	Weight
646-3/16-INS	3/16"	6" (152.4 mm)	Black	9.75" (247.7 mm)	0.15 lb (0.07 kg)
646-1/4-INS	1/4"	6" (152.4 mm)	Red	9.75" (247.7 mm)	0.20 lb (0.09 kg)
646-5/16-INS	5/16"	6" (152.4 mm)	Yellow	9.75" (247.7 mm)	0.20 lb (0.09 kg)
646-11/32-INS	11/32"	6" (152.4 mm)	Green	9.75" (247.7 mm)	0.20 lb (0.09 kg)
646-3/8-INS	3/8"	6" (152.4 mm)	Blue	10.313" (262 mm)	0.25 lb (0.11 kg)
646-7/16-INS	7/16"	6" (152.4 mm)	Brown	10.313" (262 mm)	0.25 lb (0.11 kg)
646-1/2-INS	1/2"	6" (152.4 mm)	Red	11.375" (288.9 mm)	0.35 lb (0.16 kg)
646-9/16-INS	9/16"	6" (152.4 mm)	Orange	11.375" (288.9 mm)	0.40 lb (0.18 kg)
646-5/8-INS	5/8"	6" (152.4 mm)	Yellow	11.375" (288.9 mm)	0.40 lb (0.18 kg)

3/16" magnetic nut driver does not have hollow shaft

Insulated Nut Driver Sets

9-Piece Insulated Cushion-Grip Hollow-Shaft Nut Driver Set - 6" (152 mm) Shafts

Includes core insulated nut driver features plus:

- Features assortment of popular sized nut drivers
- Highly durable, black nylon case features: nylon-zipper closure, polypropylene handles, custom-fitted tool pockets; extra pocket is provided for storage of papers or other items
- Overall case dimensions are: 15" W x 12-3/4" L x 3-1/2" D (381 mm x 324 mm x 89 mm)
- Replacement case available Cat. No. 33534



33524



Cat. No.	Set Contains	Weight		
33524		6.0 lb (2.7 kg)		
Cat. No.	Nut Driver Sizes	Shaft Length	Color Code	Overall Length
646-3/16-INS	3/16"	6" (152.4 mm)	Black	9.75" (247.7 mm)
646-1/4-INS	1/4"	6" (152.4 mm)	Red	9.75" (247.7 mm)
646-5/16-INS	5/16"	6" (152.4 mm)	Yellow	9.75" (247.7 mm)
646-11/32-INS	11/32"	6" (152.4 mm)	Green	9.75" (247.7 mm)
646-3/8-INS	3/8"	6" (152.4 mm)	Blue	10.313" (262 mm)
646-7/16-INS	7/16"	6" (152.4 mm)	Brown	10.313" (262 mm)
646-1/2-INS	1/2"	6" (152.4 mm)	Red	11.375" (288.9 mm)
646-9/16-INS	9/16"	6" (152.4 mm)	Orange	11.375" (288.9 mm)
646-5/8-INS	5/8"	6" (152.4 mm)	Yellow	11.375" (288.9 mm)
33534	Heavy-Duty Polyester Case			

3/16" magnetic nut driver does not have hollow shaft





Insulated Tool Kits

Utility Insulated 13-Piece Tool Kit

- Cuts ACSR, screws, nails, and most hardened wire (Cat. No. D2000-9NE-INS, D2000-28-INS, D2000-48-INS)
- The custom case includes two pallets with custom-fitted pockets for each tool, piano-hinged case cover has both a combination lock and two key-locked latches for security, storage space behind the pallets to keep important papers and accessory items
- Inside dimensions: 17-3/4" W x 14-1/4" D x 8" H (451 mm x 362 mm x 203 mm)
- Overall dimensions: 18-7/8" W x 15-3/8" D x 8-1/4" H (79 mm x 391 mm x 210 mm)
- Replacement case (Cat. No. 33535) available



33525

Cat. No.	Kit Contains	Weight
33525	13 Piece Insulated Utility Tool Kit	20.1 lb (9.1 kg)
Cat. No.	Description	
D2000-9NE-INS	Side Cutting Pliers, Heavy Duty Insulated, 9"	
D2000-28-INS	Diagonal-Cutting Pliers, Insulated, 8"	
D2000-48-INS	Insulated Pliers, 8" Diagonal Cutters	
D203-8-INS	Long Nose Cutting Pliers, Insulated, 8"	
602-4-INS	1/4" Cabinet Tip Insulated Screwdriver, 4"	
602-7-INS	Insulated Screwdriver, 5/16" Cabinet, 7"	
602-8-INS	Insulated Screwdriver, 3/8" Cabinet, 8"	
6334INS	Insulated Screwdriver, #1 Phillips Tip, 4"	
603-4-INS	Insulated Screwdriver, #2 Phillips Tip, 4"	
6337INS	Insulated Screwdriver, #3 Phillips, 7" Shank	
63050-INS	Cable Cutter, Insulated, High Leverage	
D502-10-INS	10" Pump Pliers, Insulated	
1571INS	Lineman's Skinning Knife, Insulated	
33535	Case for Utility Tool Kit 33525	

See individual tool listing for more details

Utility Insulated 13-Piece Tool Kit with Roll-up Case

- Cuts ACSR, screws, nails, and most hardened wire (Cat. No. D2000-9NE-INS, D2000-28-INS, D2000-48-INS)
- The light, compact, soft roll-up carry case provides protective storage with custom-fitted pockets for each tool
- Kit includes a padded, adjustable shoulder strap
- Case dimensions: Opened 24-1/2" x 24-1/2" (622 mm x 622 mm), Closed 24-1/2" x 5-1/2" (622 mm x 140 mm)



33525SC

Cat. No.	Kit Contains	Weight
33525SC	Insulated Utility Tool Kit 13 Piece	9.8 lb (4.4 kg)
Cat. No.	Description	
D2000-9NE-INS	Side Cutting Pliers, Heavy Duty Insulated, 9"	
D2000-28-INS	Diagonal-Cutting Pliers, Insulated, 8"	
D2000-48-INS	Insulated Pliers, 8" Diagonal Cutters	
D203-8-INS	Long Nose Cutting Pliers, Insulated, 8"	
602-4-INS	1/4" Cabinet Tip Insulated Screwdriver, 4"	
602-7-INS	Insulated Screwdriver, 5/16" Cabinet, 7"	
602-8-INS	Insulated Screwdriver, 3/8" Cabinet, 8"	
6334INS	Insulated Screwdriver, #1 Phillips Tip, 4"	
603-4-INS	Insulated Screwdriver, #2 Phillips Tip, 4"	
6337INS	Insulated Screwdriver, #3 Phillips, 7" Shank	
63050-INS	Cable Cutter, Insulated, High Leverage	
D502-10-INS	10" Pump Pliers, Insulated	
1571INS	Lineman's Skinning Knife, Insulated	
33535SC	Case for Utility Tool Kit 33525SC	

See individual tool listing for more details

See page 297 for additional information on warnings.



Insulated Tool Kits

General-Purpose Insulated 22-Piece Tool Kit

- Cat. No. D2000-9NE-INS, D2000-28-INS, D2000-48-INS cuts ACSR, screws, nails, and most hardened wire
- Case includes three pallets with custom-fitted pockets for each tool, piano-hinged cover has both a combination lock and two key-locked latches for security, storage space behind the pallets to keep important papers and accessory items
- Inside dimensions: 7-3/4" W x 14-1/4" D x 8" H (197 mm x 362 mm x 203 mm)
- Overall dimensions: 18-7/8" W x 15-3/8" D x 8-1/4" H (479 mm x 391 mm x 210 mm)
- Replacement case (Cat. No. 33537) available



Cat. No.	Kit Contains	Weight
33527	General Purpose Insulated Tool Kit 22-Piece	24.3 lb (11.0 kg)
Cat. No.	Description	
D2000-9NE-INS	Side Cutting Pliers, Heavy Duty Insulated, 9"	
12098-INS	Insulated Universal Combination Pliers, 8"	
D2000-28-INS	Diagonal-Cutting Pliers, Insulated, 8"	
D2000-48-INS	Insulated Pliers, 8" Diagonal Cutters	
D203-8N-INS	Long Nose Cutting Pliers, Insulated 8" Skinner	
D220-7-INS	Insulated Pliers, Diagonal Cutters, 7"	
D203-6-INS	Long Nose Cutting Pliers, Insulated, 6"	
D203-7-INS	Long Nose Side Cutting Pliers, Insulated, 7"	
601-4-INS	Insulated Screwdriver, 3/16" Cabinet, 4"	
601-7-INS	Insulated Screwdriver, 3/16" Cabinet, 7"	
612-4-INS	Insulated 1/8" Slotted Screwdriver, 4"	
602-4-INS	1/4" Cabinet Tip Insulated Screwdriver, 4"	
602-7-INS	Insulated Screwdriver, 5/16" Cabinet, 7"	
602-8-INS	Insulated Screwdriver, 3/8" Cabinet, 8"	
6334INS	Insulated Screwdriver, #1 Phillips Tip, 4"	
603-4-INS	Insulated Screwdriver, #2 Phillips Tip, 4"	
6337INS	Insulated Screwdriver, #3 Phillips, 7" Shank	
D502-10-INS	10" Pump Pliers, Insulated	
11045-INS	Insulated Wire Stripper and Cutter	
63050-INS	Cable Cutter, Insulated, High Leverage	
1571INS	Lineman's Skinning Knife, Insulated	
1005-INS	Insulated Crimping/Cutting Tool	
33537	Case for Insulated Tool Kit 33527	

See individual tool listing for more details.

33527





Insulated Tool Kits

Premium Insulated 8-Piece Tool Kit

- Cat. No. D2000-9NE-INS and D2000-48-INS cut ACSR, screws, nails and most hardened wire
- Highly durable, black nylon case features: nylon-zipper closure, polypropylene handles, custom-fitted tool pockets
- Overall case dimensions are: 15-1/2" W x 11" D x 2-1/2" H (394 mm x 279 mm x 64 mm)
- Replacement case (Cat. No. 33536) available

Cat. No.	Kit Contains	Weight
33529	8 Piece Premium Insulated Tool Kit	6.9 lb (3.1 kg)
Cat. No.	Description	
D2000-9NE-INS	Side Cutting Pliers, Heavy Duty Insulated, 9"	
D2000-48-INS	Insulated Pliers, 8" Diagonal Cutters	
D203-8N-INS	Long Nose Cutting Pliers, Insulated 8" Skinner	
601-6-INS	Insulated 3/16" Cabinet - 6" Screwdriver	
602-4-INS	1/4" Cabinet Tip Insulated Screwdriver, 4"	
603-4-INS	Insulated Screwdriver, #2 Phillips Tip, 4"	
63050-INS	Cable Cutter, Insulated, High Leverage	
11055-INS	Insulated Klein-Kurve® Wire Stripper/Cutter	
33536	Case for Insulated Tool Kit 33529	

See individual tool listing for more details.



33529

Basic Insulated 8-Piece Tool Kit

- Highly durable, black nylon case features: nylon-zipper closure, polypropylene handles, custom-fitted tool pockets
- Overall case dimensions are: 15-1/2" W x 11" D x 2-1/2" H (394 mm x 279 mm x 64 mm)
- Replacement case (Cat. No. 33536) available

Cat. No.	Kit Contains	Weight
33526	Basic Insulated Tool Kit, 1000-Volt, 8-Piece	6.9 lb (3.1 kg)
Cat. No.	Description	
D213-9NE-INS	Side Cutting Pliers, New England Insulated, 9"	
D228-8-INS	8" Insulated Pliers, Diagonal Cutters	
D203-8N-INS	Long Nose Cutting Pliers, Insulated 8" Skinner	
601-6-INS	Insulated 3/16" Cabinet - 6" Screwdriver	
602-4-INS	1/4" Cabinet Tip Insulated Screwdriver, 4"	
603-4-INS	Insulated Screwdriver, #2 Phillips Tip, 4"	
63050-INS	Cable Cutter, Insulated, High Leverage	
11045-INS	Insulated Wire Stripper and Cutter	
33536	Case for Insulated Tool Kit 33529	

See individual tool listing for more details.



33526



Screwdrivers, Nut Drivers and Accessories

Offering a variety of tip types, hex sizes, shaft lengths, and handle designs, Klein has the screwdrivers and nut drivers professionals demand to get the job done with comfort and ease.



For Professionals...
Since 1857™

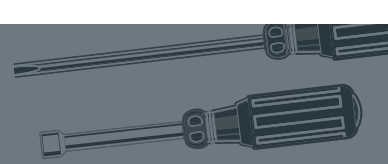

Introduction

Extra-quality features have made the Klein name famous for hand tools – features that assure greater convenience, comfort and efficiency in use, plus exceptional strength and durability.

All Klein drivers are made of the highest quality tempered steel and carefully heat-treated for maximum strength. Shafts have integral flanges that provide an extra-strong, torque-proof anchor in the handle. Strong, durable black tips are forged and precision ground with square edges to fit screw openings securely. They resist slip-page and provide positive turning action.

Cushion-Grip screwdrivers feature super-comfortable, sure-grip handles on top-quality blades for the professional. All Klein screwdrivers meet or exceed applicable ANSI and MIL specifications.

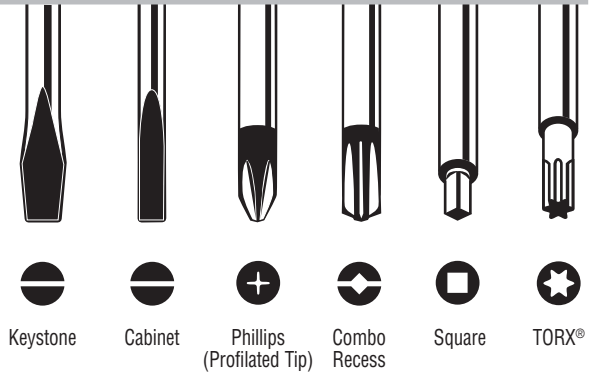

Using Screwdrivers and Nut Drivers

The size of the screw or nut and the type of opening it has determines which driver to use. Here are a few tips on how to use a driver that can be of benefit, because screwdrivers are the most often misused and abused hand tools of all.

1. Never use a driver to do another tool's job.

Using a driver as a pry bar, scraper, or a chisel can ruin the tool, spoil the work and cause injury.

2. Never push a driver beyond its capacity.

Make a pilot hole for the screw for easier driving. Use square-shank drivers for heavy work.

3. Never expose a driver to excessive heat.

Direct flame can draw the temper from the metal, weakening and possibly warping it, making it unsafe and inefficient to use.

4. Never use a driver at an angle to the screw.

Always keep the shank perpendicular to the screw head. Driving at an angle or using a point that is too small can spoil the screw or slip and damage the work.

5. Never depend on a driver's handle or covered blade to insulate you from electricity.

Plastic and Cushion-Grip handles are intended only to provide a firm, comfortable grip. Insulated blades are intended only as a protective measure against shorting out components. Only use insulated tools that are marked with the official international 1000-volt rating symbol if there is any chance that the tool will make contact with an energized source.

6. Discard damaged or worn drivers.

TORX® is a registered trademark of Acument Intellectual Properties, LLC.

MAGNETIZER

Quickly **magnetize** and **demagnetize** screwdriver tips and bits using powerful rare-earth magnets

To magnetize screwdriver:

Insert screwdriver shaft fully into magnetizing slot; avoid rotating shaft while drawing out slowly

To demagnetize screwdriver:

Insert shaft fully into smallest demagnetizing slot that fits; avoid rotating shaft while drawing out slowly



Cat. No.	Overall Length	Overall Height	Overall Width	Weight
MAG2	2.203" (56 mm)	0.703" (17.9 mm)	1.094" (27.8 mm)	1.1 oz (32 g)

Fits these drivers

- #3 Phillips
- 1/4" Keystone (round or square shank)
- 5/16" Cabinet
- #2 Phillips Insulated
- 1/4" Cabinet Insulated
- Most precision screwdrivers



See page 297 for additional information on warnings.



Cushion-Grip Screwdrivers

Meets or exceeds applicable ASME / ANSI specifications

Tip-Ident® quickly identifies the type of screwdriver and tip orientation

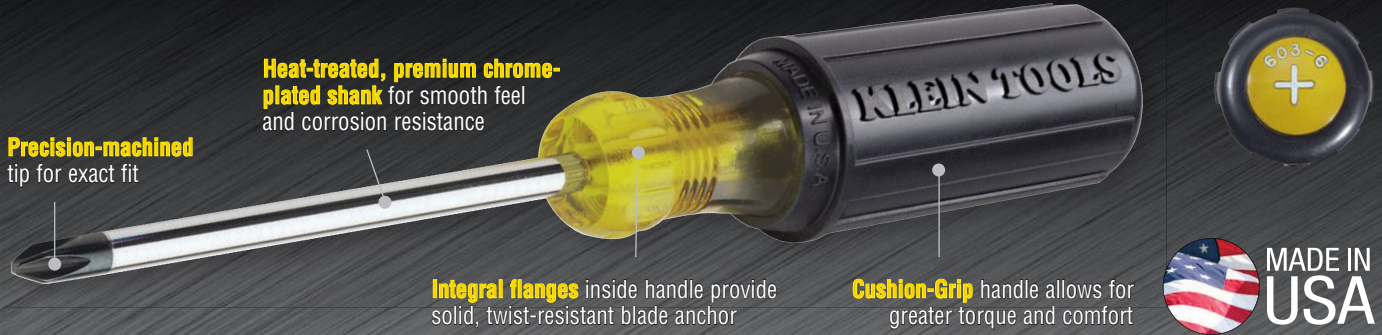

Color-Coded Cushion-Grip Screwdrivers

Includes core Cushion-Grip screwdriver features plus:

- Color-coded handle ends for quick and easy identification
- TORX® tip drive cuts slippage, saves fasteners and transmits more torque to the work

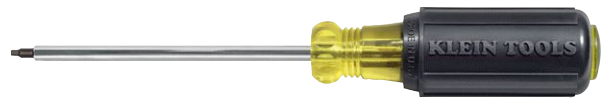

660

Cat. No.	Tip Type	Shank Type	Shank Length	Color Code	Overall Length	Weight
660	#0 Square-Recess	Round	4" (101.6 mm)	Yellow	7.75" (196.9 mm)	0.20 lb (0.09 kg)
661	#1 Square-Recess	Round	4" (101.6 mm)	Green	7.75" (196.9 mm)	0.20 lb (0.09 kg)
662	#2 Square-Recess	Round	4" (101.6 mm)	Red	8.25" (209.6 mm)	0.30 lb (0.14 kg)
663	#3 Square-Recess	Round	4" (101.6 mm)	Black	8.25" (209.6 mm)	0.30 lb (0.14 kg)
665	#1 Square-Recess	Round	8" (203.2 mm)	Green	11.75" (298.5 mm)	0.30 lb (0.14 kg)
666	#2 Square-Recess	Round	8" (203.2 mm)	Red	12.25" (311.2 mm)	0.40 lb (0.18 kg)
667	#3 Square-Recess	Round	8" (203.2 mm)	Black	12.25" (311.2 mm)	0.40 lb (0.18 kg)
668	#1 Square-Recess	Round	1.5" (38.1 mm)	Green	3.438" (87.3 mm)	0.15 lb (0.07 kg)
19542	T15 TORX®	Round	4" (101.6 mm)	Yellow	8.313" (211.2 mm)	0.20 lb (0.09 kg)
19543	T20 TORX®	Round	4" (101.6 mm)	Green	8.313" (211.2 mm)	0.25 lb (0.11 kg)
19544	T25 TORX®	Round	4" (101.6 mm)	Blue	8.313" (211.2 mm)	0.25 lb (0.11 kg)
19545	T27 TORX®	Round	4" (101.6 mm)	Brown	8.313" (211.2 mm)	0.25 lb (0.11 kg)
19546	T30 TORX®	Round	4" (101.6 mm)	Red	8.313" (211.2 mm)	0.25 lb (0.11 kg)

TORX® is a registered trademark of Acument Intellectual Properties, LLC.

Cat. No.	Set Contains	Weight
19555	TORX® Cushion-Grip Screwdriver Set 5-Piece	1.2 lb (0.5 kg)

Cat. No.	Description
19542	T15 TORX® Screwdriver, Round Shank, Cushion Grip
19543	T20 TORX® Screwdriver, Round Shank, Cushion Grip
19544	T25 TORX® Screwdriver Round Shank, Cushion Grip
19545	T27 TORX® Screwdriver, Round Shank, Cushion Grip
19546	T30 TORX® Screwdriver, Round Shank, Cushion Grip

Cat. No.	Set Contains	Weight
85664	4 Piece Square Recess Screwdriver Set	1.5 lb (0.7 kg)

Cat. No.	Description
660	#0 Square Recess Screwdriver 4" Shank
661	Screwdriver, #1 Square Recess Tip, 4" Shank
662	#2 Square Screwdriver with 4" Round Shank
663	#3 Square Recess Screwdriver, 4" Round Shank

Miniature Screwdrivers



608-6

Cat. No.	Tip Type	Shank Type	Shank Length	Overall Length	Weight
604-3	#0 Phillips	Round	3" (76.2 mm)	5.75" (146.1 mm)	0.6 oz (17 g)
606-2	1/16" (1.59 mm) Keystone	Round	2" (50.8 mm)	4.75" (120.7 mm)	0.5 oz (14 g)
607-3	3/32" (2.4 mm) Cabinet	Round	3" (76.2 mm)	5.75" (146.1 mm)	0.6 oz (17 g)
607-4	3/32" (2.4 mm) Cabinet	Round	4" (101.6 mm)	6.75" (171.5 mm)	0.6 oz (17 g)
608-2	1/8" (3.2 mm) Cabinet	Round	2" (50.8 mm)	4.75" (120.7 mm)	0.5 oz (14 g)
608-3	1/8" (3.2 mm) Cabinet	Round	3" (76.2 mm)	5.75" (146.1 mm)	0.6 oz (17 g)
608-4	1/8" (3.2 mm) Cabinet	Round	4" (101.6 mm)	6.75" (171.5 mm)	0.8 oz (23 g)
608-6	1/8" (3.2 mm) Cabinet	Round	6" (152.4 mm)	8.75" (222.3 mm)	0.8 oz (23 g)
608-8	1/8" (3.2 mm) Cabinet	Round	8" (203.2 mm)	10.75" (273.1 mm)	0.8 oz (23 g)
608-10	1/8" (3.2 mm) Cabinet	Round	10" (254.0 mm)	12.75" (323.9 mm)	0.8 oz (23 g)

Cat. No.	Set Contains	Weight
85484	Mini Cushion-Grip Screwdriver Set 4 Piece	0.14 lb (0.06 kg)

Cat. No.	Description
604-3	#0 Phillips Mini Screwdriver, 3", Cushion Grip
606-2	1/16" Keystone Tip Mini Screwdriver, 2"
607-3	Mini Screwdriver, 3/32" Cabinet Tip, 3"
608-3	Mini Screwdriver, 1/8" Cabinet, 3" Shank



Cushion-Grip Screwdrivers

Cushion-Grip Screwdrivers

Includes core Cushion-Grip screwdriver features plus:

- Narrow cabinet-tip permits blade access where space is limited
- Precision machined combo-tip designed for combination head screws
- Precision machined Phillips tip provides a more consistent geometric symmetry than conventional Phillips screwdrivers to accurately fit and torque without slippage
- Heavy-duty square shank and hex bolster allows wrench-assisted turning
- Bolster reinforces shank for hard use



Cat. No.	Tip Type	Shank Type	Shank Length	Overall Length	Weight
600-1	5/16" (7.9 mm) Cabinet	Round	1.5" (38.1 mm)	3.438" (87.3 mm)	1.6 oz (45 g)
601-3	3/16" (4.8 mm) Cabinet	Round	3" (76.2 mm)	6.75" (171.5 mm)	1.6 oz (45 g)
601-4	3/16" (4.8 mm) Cabinet	Round	4" (101.6 mm)	7.75" (196.9 mm)	2.4 oz (68 g)
601-6	3/16" (4.8 mm) Cabinet	Round	6" (152.4 mm)	9.75" (247.7 mm)	2.4 oz (68 g)
601-8	3/16" (4.8 mm) Cabinet	Round	8" (203.2 mm)	11.75" (298.5 mm)	3.2 oz (91 g)
601-10	3/16" (4.8 mm) Cabinet	Round	10" (254.0 mm)	13.75" (349.3 mm)	3.2 oz (91 g)
7314	#1 Combo	Round	4" (101.6 mm)	8.344" (211.9 mm)	4.8 oz (136 g)
7324	#2 Combo	Round	4" (101.6 mm)	8.344" (211.9 mm)	4.8 oz (136 g)
603-1	#2 Phillips	Round	1.5" (38.1 mm)	3.438" (87.3 mm)	1.6 oz (45 g)
603-3	#1 Phillips	Round	3" (76.2 mm)	6.75" (171.5 mm)	2.4 oz (68 g)
603-4	#2 Phillips	Round	4" (101.6 mm)	8.25" (209.6 mm)	4.0 oz (113 g)
603-6	#3 Phillips	Round	6" (152.4 mm)	11" (279.4 mm)	5.6 oz (159 g)
603-7	#2 Phillips	Round	7" (177.8 mm)	11.313" (287.4 mm)	4.8 oz (136 g)
603-10	#2 Phillips	Round	10" (254.0 mm)	14.313" (363.6 mm)	5.6 oz (159 g)
Heavy Duty					
605-4	1/4" (6.4 mm) Cabinet	Round	4" (101.6 mm)	8.344" (211.9 mm)	4.0 oz (113 g)
605-6	1/4" (6.4 mm) Cabinet	Round	6" (152.4 mm)	10.344" (262.7 mm)	4.8 oz (136 g)
605-8	1/4" (6.4 mm) Cabinet	Round	8" (203.2 mm)	12.344" (313.5 mm)	4.8 oz (136 g)
605-10	1/4" (6.4 mm) Cabinet	Round	10" (254.0 mm)	14.344" (364.3 mm)	5.6 oz (159 g)
Heavy Duty with Bolster					
600-4	1/4" (6.4 mm) Keystone	Square	4" (101.6 mm)	8.344" (211.9 mm)	4.0 oz (113 g)
600-6	5/16" (7.9 mm) Keystone	Square	6" (152.4 mm)	10.938" (277.8 mm)	6.4 oz (181 g)
600-8	3/8" (9.52 mm) Keystone	Square	8" (203.2 mm)	13.438" (341.3 mm)	10.4 oz (295 g)
600-12	1/2" (12.7 mm) Keystone	Square	12" (304.8 mm)	17.438" (442.9 mm)	12.8 oz (363 g)
Heavy Duty with Hex Bolster					
602-3	7/32" (5.6 mm) Keystone	Round	3" (76.2 mm)	6.75" (171.5 mm)	2.4 oz (68 g)
602-4	1/4" (6.4 mm) Keystone	Round	4" (101.6 mm)	8.344" (211.9 mm)	4.0 oz (113 g)
602-6	5/16" (7.9 mm) Keystone	Round	6" (152.4 mm)	10.938" (277.8 mm)	5.6 oz (159 g)
602-8	3/8" (9.52 mm) Keystone	Round	8" (203.2 mm)	13.438" (341.3 mm)	8.8 oz (249 g)
602-10	3/8" (9.52 mm) Keystone	Round	10" (254.0 mm)	15.438" (392.1 mm)	9.6 oz (272 g)
602-12	3/8" (9.52 mm) Keystone	Round	12" (304.8 mm)	17.438" (442.9 mm)	10.4 oz (295 g)

Cat. No.	Set Contains	Weight
85078	8 Piece Cushion-Grip Screwdriver Set	1.7 lb (0.8 kg)

Cat. No.	Description
600-4	1/4" Screwdriver Heavy Duty Square Shank
602-6	5/16" Keystone Tip Screwdriver, 6" Length
600-1	5/16" Cabinet Tip Screwdriver 1-1/2"
601-3	3/16" Cabinet Tip Screwdriver 3"
603-3	#1 Phillips Screwdriver, 3" Round Shank
603-1	Stubby Screwdriver, #2 Phillips, 1-1/2" Shank
603-4	#2 Phillips Screwdriver 4" Round Shank
603-6	#3 Phillips Screwdriver 6" Round Shank

Cat. No.	Set Contains	Weight
85076	7 Piece Cushion-Grip Screwdriver Set	1.5 lb (0.7 kg)

Cat. No.	Description
600-4	1/4" Screwdriver Heavy Duty Square Shank
602-6	5/16" Keystone Tip Screwdriver, 6" Length
601-3	3/16" Cabinet Tip Screwdriver 3"
601-6	3/16" Cabinet Tip Screwdriver 6"
605-4	1/4" Cabinet Tip Screwdriver 4" Shank
603-3	#1 Phillips Screwdriver, 3" Round Shank
603-4	#2 Phillips Screwdriver 4" Round Shank

Cat. No.	Set Contains	Weight
85074	Screwdriver Set, Cushion Grip, 6-Piece	1.5 lb (0.7 kg)

Cat. No.	Description
600-4	1/4" Screwdriver Heavy Duty Square Shank
600-6	5/16" Keystone Screwdriver 6" SQ Shank
601-3	3/16" Cabinet Tip Screwdriver 3"
603-3	#1 Phillips Screwdriver, 3" Round Shank
603-4	#2 Phillips Screwdriver 4" Round Shank
603-6	#3 Phillips Screwdriver 6" Round Shank

Cat. No.	Set Contains	Weight
85075	Cushion-Grip Screwdriver Set, 5-Piece	1.3 lb (0.6 kg)

Cat. No.	Description
602-6	5/16" Keystone Tip Screwdriver, 6" Length
600-4	1/4" Screwdriver Heavy Duty Square Shank
601-6	3/16" Cabinet Tip Screwdriver 6"
605-6	1/4" Cabinet Tip Screwdriver, Heavy Duty, 6"
603-4	#2 Phillips Screwdriver 4" Round Shank

Cat. No.	Set Contains	Weight
85105	4 Piece Cushion-Grip Screwdriver Set	1.5 lb (0.7 kg)

Cat. No.	Description
600-6	5/16" Keystone Screwdriver 6" SQ Shank
600-4	1/4" Screwdriver Heavy Duty Square Shank
601-6	3/16" Cabinet Tip Screwdriver 6"
603-4	#2 Phillips Screwdriver 4" Round Shank

Cat. No.	Set Contains	Weight
85071	Stubby Screwdriver Set, Cushion Grip, 2-Piece	0.30 lb (0.14 kg)

Cat. No.	Description
600-1	5/16" Cabinet Tip Screwdriver 1-1/2"
603-1	Stubby Screwdriver, #2 Phillips, 1-1/2" Shank

Cat. No.	Set Contains	Weight
32378	Combo Tip Driver Set 4"	1.5 lb (0.7 kg)

Cat. No.	Description
7314	#1 Combo-Tip Driver, 4" Fixed Blade
7324	#2 Combo Tip Driver, 4" Fixed Blade

Cat. No.	Set Contains	Weight
85072	Long Blade Screwdriver Set, 10", 2-Piece	0.70 lb (0.32 kg)

Cat. No.	Description
603-10	#2 Phillips Screwdriver 10" Round Shank
605-10	1/4" Cabinet Tip Screwdriver, 10" Shank

See page 297 for additional information on warnings.



Cushion-Grip Screwdrivers

Demolition Screwdrivers

Includes core Cushion-Grip screwdriver features plus:

- Engineered, manufactured and tested for prying, chiseling and punching
- Plated metal strike cap to protect handle from hammer blows
- Heat treated metal shaft runs complete length of handle to metal strike cap to transfer metal strike force



602-7DD



Cat. No.	Tip Type	Shank Type	Shank Length	Overall Length	Weight
602-4DD	1/4" (6.4 mm) Cabinet	Round	4" (101.6 mm)	9" (228.6 mm)	5.9 oz (167 g)
602-7DD	5/16" (7.9 mm) Keystone	Round	7" (177.8 mm)	12.375" (314.3 mm)	9.0 oz (255 g)
6034DD	#2 Phillips	Round	4" (101.6 mm)	9" (228.6 mm)	5.9 oz (167 g)

Cat. No.	Set Contains	Weight
32008	Demolition Driver Set	0.70 lb (0.32 kg)

Cat. No.	Description
602-4DD	1/4" Keystone Demolition Driver, 4" Shank
6034DD	#2 Phillips Demolition Driver, 4" Shank

Electronics Screwdrivers

Includes core Cushion-Grip screwdriver features plus:

- Rotating cap for optimum and precise control



614-6



Cat. No.	Tip Type	Shank Type	Shank Length	Overall Length	Weight
613-3	#0 Phillips	Round	3" (76.2 mm)	6.5" (165.1 mm)	0.8 oz (23 g)
614-2	1/16" (1.59 mm) Cabinet	Round	2" (50.8 mm)	5.5" (139.7 mm)	0.8 oz (23 g)
614-3	3/32" (2.4 mm) Cabinet	Round	3" (76.2 mm)	6.5" (165.1 mm)	0.8 oz (23 g)
614-4	1/8" (3.2 mm) Cabinet	Round	4" (101.6 mm)	7.5" (190.5 mm)	0.8 oz (23 g)
614-6	1/8" (3.2 mm) Cabinet	Round	6" (152.4 mm)	9.5" (241.3 mm)	0.8 oz (23 g)

Cat. No.	Set Contains	Weight
85614	5 Piece Electronics Screwdriver Set	0.80 lb (0.36 kg)

Cat. No.	Description
614-2	1/16" Slotted Electronics Screwdriver, 2"
614-3	3/32" Slotted Electronics Screwdriver, 3"
614-4	1/8" Cabinet Electronics Screwdriver, 4"
614-6	1/8" Cabinet Electronics Screwdriver, 6"
613-3	#0 Phillips Electronics Screwdriver, 3"

Coated Screwdrivers

Includes core Cushion-Grip screwdriver features plus:

- Plastic coated for circuit protection only. NOT INSULATED
- Special plastic coating resists cutting, cracking and chipping
- Thin coating permits use in confined areas



620-4

Cat. No.	Tip Type	Shank Type	Shank Length	Overall Length	Weight
620-3	3/16" (4.8 mm) Cabinet	Round	3" (76.2 mm)	6.75" (171.5 mm)	2.4 oz (68 g)
620-4	1/4" (6.4 mm) Cabinet	Round	4" (101.6 mm)	8.344" (211.9 mm)	3.2 oz (91 g)
620-6	5/16" (7.9 mm) Cabinet	Round	6" (152.4 mm)	10.938" (277.8 mm)	6.4 oz (181 g)
620-8	3/8" (9.52 mm) Cabinet	Round	8" (203.2 mm)	13.438" (341.3 mm)	9.6 oz (272 g)
621-6	3/16" (4.8 mm) Cabinet	Round	6" (152.4 mm)	9.75" (247.7 mm)	3.2 oz (91 g)
621-8	3/16" (4.8 mm) Cabinet	Round	8" (203.2 mm)	11.75" (298.5 mm)	3.2 oz (91 g)

2-in-1 Rapi-Driv®

- Interchangeable bit holder allows quick switching between tip styles and works with other standard size bits
- Crank-action handle allows you to spin screws fast with one hand
- Blast finish bit provides firm grip on fasteners to reduce cam out



67100



Cat. No.	Phillips Bits	Slotted Bits	Shank Length	Handle Color	Overall Length	Weight
67100	#2	3/16" (4.8 mm)	6" (152.4 mm)	Black	9.75" (247.7 mm)	0.26 lb (0.12 kg)

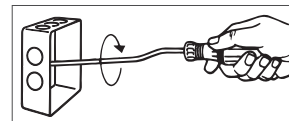

Cushion-Grip Screwdrivers

Rapi-Driv® Screwdrivers

- Crank-action handle spins screws fast with one hand
- Saves time and effort, especially on long-threaded screws in switch plates, light fixtures, etc.



670-6

Cat. No.	Tip Type	Shank Type	Shank Length	Overall Length	Weight
670-3	3/16" (4.8 mm) Cabinet	Round Rapi-Driv®	4" (101.6 mm)	7.75" (196.9 mm)	2.4 oz (68 g)
670-6	3/16" (4.8 mm) Cabinet	Round Rapi-Driv®	6" (152.4 mm)	9.75" (247.7 mm)	3.2 oz (91 g)
671-6	1/4" (6.4 mm) Cabinet	Round Rapi-Driv®	6" (152.4 mm)	9.75" (247.7 mm)	3.2 oz (91 g)
682-6	#2 Phillips	Round Rapi-Driv®	6" (152.4 mm)	9.75" (247.7 mm)	4.0 oz (113 g)

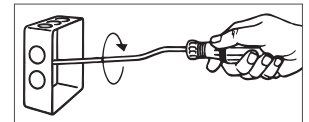

7-Piece Multiple-Application Screwdriver Set

- Specialty set for a wide variety of applications



Cat. No.	Set Contains	Weight
85077	Multi Application Screwdriver Set, 7-Piece	1.7 lb (0.8 kg)

Cat. No.	Tip Type	Shank Type	Shank Length	Overall Length
600-4	1/4" (6.4 mm) Keystone	Square	4" (101.6 mm)	8.344" (211.9 mm)
602-6	5/16" (7.9 mm) Keystone	Round	6" (152.4 mm)	10.938" (277.8 mm)
601-6	3/16" (4.8 mm) Cabinet	Round	6" (152.4 mm)	9.75" (247.7 mm)
605-6	1/4" (6.4 mm) Cabinet	Round	6" (152.4 mm)	10.344" (262.7 mm)
670-6	3/16" (4.8 mm) Cabinet	Round Rapi-Driv®	6" (152.4 mm)	9.75" (247.7 mm)
K36	1/4" (6.4 mm) Slotted	Round	6" (152.4 mm)	9.75" (247.7 mm)
603-4	#2 Phillips	Round	4" (101.6 mm)	8.25" (209.6 mm)



85077

Adjustable-Length Screwdriver Set

- Removable shank adjusts within 4" to 8" (102-208 mm) range for numerous length combinations
- Blades feature two tips for multiple screwdrivers in one tool
- Proprietary system securely holds blade - as durable as a traditional Klein fixed blade screwdriver
- Press down to extend or lengthen the shank
- Push up to retract or shorten the shank
- Components sold separately



32751



US Patent: 6,561,523

Cat. No.	Type	Tip Size	Shank Length	Overall Length	Weight
32751	Adjustable-Length Screwdriver	#2 Phillips, 1/4" (6.4 mm) Slotted	4" to 8" (101.6 to 203.2 mm)	13.375" (339.7 mm)	0.70 lb (0.32 kg)
32708	Adjustable-Length Screwdriver	#1, #2 Square	4" to 8" (101.6 to 203.2 mm)	13.375" (339.7 mm)	0.10 lb (0.05 kg)
32709	Replacement Blade	#1, #2 Square	7.75" (196.9 mm)	9" (228.6 mm)	0.10 lb (0.05 kg)
32713	Replacement Blade	#1 Phillips, 3/16" (4.8 mm) Slotted	7.75" (196.9 mm)	9" (228.6 mm)	0.10 lb (0.05 kg)
32618	Replacement Blade	#2 Phillips, 1/4" (6.4 mm) Slotted	4" to 8" (101.6 to 203.2 mm)	9.125" (231.8 mm)	0.25 lb (0.11 kg)
32619	Screwdriver Handle	—	—	5.375" (136.5 mm)	0.20 lb (0.09 kg)

Cat. No.	Set Contains	Weight
32715	Adjustable-Length Replacement Blade Set 3-Pack	0.10 lb (0.05 kg)

Cat. No.	Description
32713	Adjustable-Length Blade, #1 PH, 3/16" Slotted
32618	Adj Screwdriver Blade #2 Phillips 1/4" Slotted
32709	Adjustable-Length Screwdriver Blade, Square #1, #2

See page 297 for additional information on warnings.



Specialty Cushion-Grip Screwdrivers

2-in-1 Hex Slide Driver/Nut Driver

- Unique, patented tip switches from 1/4" size to 5/16" size
- Magnetic regardless of which driver is selected
- Twist the thumb nut to lock tip setting
- U.S. Patent 7,654,175 B2



65129



Cat. No.	Type	Tip Size	Shank Length	Overall Length	Weight
65129	Hex Driver	1/4", 5/16"	6" (152.4 mm)	10.25" (260.4 mm)	0.50 lb (0.23 kg)
65131	Hex Driver	1/4", 5/16"	1.5" (38.1 mm)	3.359" (85.3 mm)	0.18 lb (0.08 kg)

2-in-1 Hex Head Screwdriver

- 1/4" and 5/16" six-point hex nut driver
- Powerful magnets for maximum fastener retention
- Solid build quality; feels like a conventional nut driver
- Color coded bands for easy identification
- Wrench-assist to help remove stubborn fasteners



65064



Cat. No.	Type	Tip Size	Shank Length	Overall Length	Weight
65064	Hex Driver	1/4" and 5/16"	3.625" (92.1 mm)	8" (203.2 mm)	0.10 lb (0.05 kg)

Screw-Holding Screwdrivers

- Starts and drives screws with one hand when working in hard-to-reach spaces



32215



Cat. No.	Tip Type	Shank Type	Shank Length	Overall Length	Weight
32215	1/4" (6.4 mm) Cabinet	Round	7" (177.8 mm)	11.25" (285.8 mm)	5.1 oz (145 g)
32216	#2 Phillips	Round	7" (177.8 mm)	11.25" (285.8 mm)	5.1 oz (145 g)

Terminal Block Screwdriver

Includes core Cushion-Grip screwdriver features plus:

- Provides exact fit for terminal block screws
- Tip is up to 19% stronger than competitors and provides 76% higher torque value than the required ASME B107 Standard



612-4



Cat. No.	Tip Type	Shank Type	Shank Length	Overall Length	Weight
612-4	1/8" (3.2 mm) Cabinet	Round	4" (101.6 mm)	7.75" (196.9 mm)	2.4 oz (68 g)

Specialty Cushion-Grip Screwdrivers

Wire Bending Screwdrivers

Includes core Cushion-Grip screwdriver features plus:

- Metal stud offers a convenient and easy way to bend, loop and connect solid wire when installing outlets and switches



605-6B



Cat. No.	Bends	Tip Type	Tip Size	Shank Type	Shank Length	Overall Length	Weight
605-4B	AWG Gauges Nos. 10, 12, 14	Cabinet	1/4" (6.4 mm)	Round	4" (101.6 mm)	8.344" (211.9 mm)	0.25 lb (0.11 kg)
605-6B	AWG Gauges Nos. 10, 12, 14	Cabinet	1/4" (6.4 mm)	Round	6" (152.4 mm)	10.344" (262.7 mm)	0.30 lb (0.14 kg)
603-4B	AWG Gauges Nos. 10, 12, 14	Phillips	#2	Round	4" (101.6 mm)	8.313" (211.2 mm)	0.25 lb (0.11 kg)

Multi-Bit Cushion-Grip Screwdrivers/Nut Drivers

15-in-1 Screwdriver/Nut Drivers

- Includes 14 different screwdriver tips plus a 1/4" (6.4 mm) nut driver
- Internal storage for screwdriver bits



INTERNAL STORAGE
in handle



32290



Cat. No.	Description	Nut Driver Sizes	Phillips Bits	Slotted Bits	Square Bits	Hex Bits	Combo Bits	Torx® Bits	Other Bits	Shank Length	Handle Color	Overall Length	Weight
32290	Multi-Bit Screwdriver with Storage 15-Piece	1/4"	#0, #1, #2, #3	4 mm, 6 mm	#1, #2	—	#1, #2	#10, #15, #20, #25	—	4" (101.6 mm)	Black	8.5" (215.9 mm)	0.50 lb (0.23 kg)
32291	Tamperproof Multi-Bit Screwdriver Set 15-Piece	1/4"	—	—	—	Pins: 1/8", 9/64", 5/32", 3/16"	—	Pins: #10, #15, #20, #25, #27, #30	Spanners: #6, #8, #10, #12	4" (101.6 mm)	Black	8.5" (215.9 mm)	0.50 lb (0.23 kg)
32292	HVAC Multi-Bit Screwdriver, 15-in-1 15-Piece	1/4"	#0, #1, #2, #3	4 mm, 6 mm	#1, #2	—	—	#10, #15, #20, #25	Schrader® Valve Insertion/ Core Removal	4" (101.6 mm)	Black	8.5" (215.9 mm)	0.50 lb (0.23 kg)

Schrader® is a registered trademark of Schrader-Bridgeport International, Inc. TORX® is a registered trademark of Acument Intellectual Properties, LLC.

11-in-1 Combo-Tip Screwdriver/Nut Driver

- Precision machined tip designed for combination head screws



32505



Cat. No.	Nut Driver Sizes	Phillips Bits	Slotted Bits	Square Bits	Combo Bits	Shank Length	Handle Color	Overall Length	Weight
32505	1/4", 5/16" 3/8"	#1, #2	1/4" (6.4 mm), 5/16" (7.9 mm)	#1, #2	#1, #2	4" (101.6 mm)	Yellow/Black	7.25" (184.2 mm)	0.50 lb (0.23 kg)

See page 297 for additional information on warnings.



Additional and replacement bits can be found on page 60

Multi-Bit Cushion-Grip Screwdrivers/Nut Drivers

11-in-1 Screwdriver/Nut Driver with Schrader® Valve Removal/Installation Bit

- Great for HVAC and other industrial applications
- Includes unique style bit for installation/removal of common TR-4 Schrader® valves and aggressive thread extractor tip for backing out broken cores



32527



Cat. No.	Nut Driver Sizes	Phillips Bits	Slotted Bits	Square Bits	Other Bits	Shank Length	Handle Color	Overall Length	Weight
32527	3/8", 5/16", 1/4"	#1, #2	1/4" (6.4 mm), 3/16" (4.8 mm)	#1, #2	Schrader® Valve Insertion/Core Removal	3" (76.2 mm)	Yellow/Black	7.75" (196.9 mm)	0.44 lb (0.20 kg)

Schrader® is a registered trademark of Schrader International, Inc.

8-in-1 HVAC Slide Driver™ Screwdriver/Nut Driver

- Unique, patented head slides back and forth to switch from 1/4" to 5/16" magnetic hex-head screwdriver
- Thumb nut locks tip setting
- Features a specialty bit for installation/removal of common TR-4 Schrader® valves
- Includes 1/4" and 3/8" hollow nut drivers, as well as #2 Phillips, 1/8" (3 mm) and 1/4" (6 mm) slotted screwdriver tips
- Great for HVAC applications including thermostat installation and control work
- U.S. patent 7,654,175 B2



32596

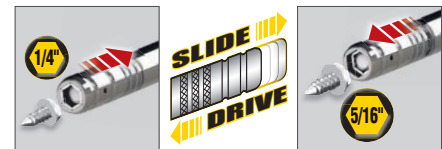

Cat. No.	Nut Driver Sizes	Phillips Bits	Slotted Bits	Other Bits	Shank Length	Handle Color	Overall Length	Weight
32596	1/4" Magnetic, 5/16" Magnetic, 1/4", 3/8"	#2	1/8" (3.2 mm), 1/4" (6.4 mm)	Schrader® Valve Insertion/ Core Removal	3.25" (82.6 mm)	Yellow/Black	7.5" (190.5 mm)	0.50 lb (0.2 kg)

Schrader® is a registered trademark of Schrader-Bridgeport International, Inc.

4-in-1 Electronics Precision Screwdrivers

- Four different tips in one tool
- Rotating cap for optimum and precise control



32581



Cat. No.	Phillips Bits	Slotted Bits	TORX® Bits	Shank Length	Handle Color	Overall Length	Weight
32581	#0, #00	1/8" (3.2 mm), 3/32" (2.4 mm)	—	2.797" (71 mm)	Yellow/Black	6.5" (165.1 mm)	1.1 oz (31 g)
32585	—	—	T7, T8, T10, T15	2.797" (71 mm)	Yellow/Black	6.5" (165.1 mm)	1.1 oz (31 g)

TORX® is a registered trademark of Acument Intellectual Properties, LLC.

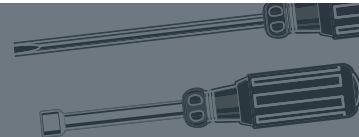

Multi-Bit Cushion-Grip Screwdrivers/Nut Drivers

Ratcheting Multi-Bit Screwdriver/Nut Driver

- High torque 3-way ratcheting mechanism, forward, reverse and locked positions for tough applications
- Interchangeable shaft holds six universal tips; converts to three nut driver sizes and one hex driver
- Strong, heat-treated nut drivers for improved torque



32558



Cat. No.	Nut Driver Sizes	Phillips Bits	Slotted Bits	Square Bits	Hex Bits	Shank Length	Handle Color	Overall Length	Weight
32558	1/4", 5/16", 3/8"	#1, #2	1/4" (6.4 mm), 3/16" (4.8 mm)	#1, #2	3/8"	2.953" (75 mm)	Yellow/Black	7.891" (200.4 mm)	0.48 lb (0.22 kg)

6-in-1 Ratcheting Stubby Screwdrivers

- Ratcheting mechanism allows user to work faster with more efficiency



32593



Cat. No.	Nut Driver Sizes	Phillips Bits	Slotted Bits	Square Bits	Shank Length	Handle Color	Overall Length	Weight
32593	1/4", 5/16"	#1, #2	1/4" (6.4 mm), 3/16" (4.8 mm)	—	1.297" (32.9 mm)	Yellow/Black	3.5" (88.9 mm)	0.10 lb (0.05 kg)
32594	1/4", 5/16"	#2	3/16" (4.8 mm)	#1, #2	1.297" (32.9 mm)	Yellow/Black	3.5" (88.9 mm)	0.10 lb (0.05 kg)

Heavy-Duty Multi-Bit Screwdriver/Nut Driver

- Superior torque for tough applications
- Interchangeable shaft holds six universal tips; converts to three nut driver sizes and one hex driver
- Strong, heat-treated nut drivers for improved torque



32557



Cat. No.	Nut Driver Sizes	Phillips Bits	Slotted Bits	Square Bits	Hex Bits	Shank Length	Handle Color	Overall Length	Weight
32557	1/4", 5/16", 3/8"	#1, #2	1/4" (6.4 mm), 3/16" (4.8 mm)	#1, #2	3/8"	2.953" (75 mm)	Yellow/Black	7.891" (200.4 mm)	0.48 lb (0.22 kg)

See page 297 for additional information on warnings.



Additional and replacement bits can be found on page 60

Multi-Bit Cushion-Grip Screwdrivers/Nut Drivers

Multi-Bit Screwdriver/Nut Drivers

- Integrated screwdriver/nut driver shaft holds popular tips and converts nut driver sizes



32476



Cat. No.	Nut Driver Sizes	Phillips Bits	Slotted Bits	Square Bits	TORX® Bits	Shank Length	Handle Color	Overall Length	Weight
32476	5/16"	#1, #2	1/4" (6.4 mm), 3/16" (4.8 mm)	—	—	4" (101.6 mm)	Yellow/Black	7.75" (196.9 mm)	0.48 lb (0.22 kg)
32477	5/16", 1/4"	#1, #2	1/4" (6.4 mm), 3/16" (4.8 mm)	#1, #2	T10, T15	4" (101.6 mm)	Yellow/Black	7.75" (196.9 mm)	0.50 lb (0.23 kg)
32500	3/8", 5/16", 1/4"	#1, #2	1/4" (6.4 mm), 3/16" (4.8 mm)	#1, #2	T10, T15	3" (76.2 mm)	Yellow/Black	7.25" (184.2 mm)	0.50 lb (0.23 kg)

TORX® is a registered trademark of Acument Intellectual Properties, LLC

Stubby Multi-Bit Screwdriver/Nut Driver

- Compact design features standard 1-1/4" (32 mm) shaft allowing easy access to tight work spaces
- Shaft holds four universal tips and converts to two nut driver sizes



32561



Cat. No.	Nut Driver Sizes	Phillips Bits	Slotted Bits	Square Bits	Shank Length	Handle Color	Overall Length	Weight
32561	1/4", 5/16"	#1, #2	3/16" (4.8 mm), 1/4" (6.4 mm)	—	1.266" (32.2 mm)	Yellow/Black	3.406" (86.5 mm)	0.16 lb (0.07 kg)
32562	1/4", 5/16"	#2	3/16" (4.8 mm)	#1, #2	1.266" (32.2 mm)	Yellow/Black	3.406" (86.5 mm)	0.16 lb (0.07 kg)

Extended-Reach Multi-Bit Screwdrivers/Nut Drivers

- Interchangeable shaft holds four universal tips and converts to two nut driver sizes
- Extended shafts and blades provide 39% longer reach
- Small diameter shaft for comfortable grip and quick, easy turning



32559



Cat. No.	Nut Driver Sizes	Phillips Bits	Slotted Bits	Square Bits	Shank Length	Handle Color	Overall Length	Weight
32559	1/4", 5/16"	#1, #2	1/4" (6.4 mm), 3/16" (4.8 mm)	—	4.109" (104.4 mm)	Yellow/Black	9.109" (231.4 mm)	0.41 lb (0.19 kg)
32560	1/4", 5/16"	#2	1/4" (6.4 mm)	#1, #2	4.109" (104.4 mm)	Yellow/Black	9.109" (231.4 mm)	0.41 lb (0.19 kg)

Multi-Bit Screwdrivers/Nut Drivers

10-in-1 Folding Screwdriver/Nut Driver

10-FOLD™



- Conveniently folds up for easy storage or to fit into your pocket
- Each driver arm contains four interchangeable bit styles and two nut drivers
- Unfold each driver arm up to a full 180° for straight on driving power, or at 90° for extra leverage on stubborn fasteners
- Quick release button easily unlocks a fully extended driver arm

32534
Schrader®



32535
Standard



32536
TORX®



32537
Tamperproof TORX®



32538
Standard Hex



32539
Metric Hex



Cat. No.	Nut Driver Sizes	Phillips Bits	Slotted Bits	Square Bits	Hex Bits	TORX® Bits	Other Bits	Handle Color	Weight
32534	5/16", 1/4"	#1, #2	1/4" (6.4 mm), 3/16" (4.8 mm)	#1, #2	—	—	Schrader® Valve Insertion/ Core Removal	Blue	0.37 lb (0.17 kg)
32535	5/16", 1/4"	#1, #2	1/4" (6.4 mm), 3/16" (4.8 mm)	#1, #2	—	T10, T15	—	Black	0.37 lb (0.17 kg)
32536	5/16", 1/4"	—	—	—	—	T6, T7, T8, T10, T15, T20, T25, T27	—	Green	0.37 lb (0.17 kg)
32537	5/16", 1/4"	—	—	—	—	T7, T8, T9, T10, T15, T20, T25, T27	—	Green	0.37 lb (0.17 kg)
32538	5/16", 1/4"	—	—	—	1/16", 5/64", 3/32", 7/64", 1/8", 9/64", 5/32", 3/16"	—	—	Red	0.37 lb (0.17 kg)
32539	5/16", 1/4"	—	—	—	0.9 mm, 1.3 mm, 1.5 mm, 2 mm, 2.5 mm, 3 mm, 4 mm, 5 mm	—	—	Blue	0.37 lb (0.17 kg)

Schrader® is a registered trademark of Schrader-Bridgeport International, Inc., TORX® is a registered trademark of Acument Intellectual Properties, LLC.

Magnetic Screwdriver Bit Sets

Non-Ratcheting Magnetic Screwdriver with 32-Piece Tamperproof Bit Set

- Sturdy bit and screw holding magnet allows for screws to fit securely in place for easy use
- Durable PVC black block allows for easy storage of standard 1/4" bits
- Includes complete tamperproof bit set in block



TAMPERPROOF BIT SET INCLUDED WITH SET, ALSO SOLD SEPARATELY 32525



STANDARD BIT SET SOLD SEPARATELY 32526

Cat. No.	Nut Driver Sizes	Phillips Bits	Slotted Bits	Square Bits	Hex Bits	TORX® Bits	Other Bits	Shank Length	Handle Color	Overall Length	Weight
32510	1/4"	—	—	—	3/32", 7/64", 1/8", 9/64", 5/32", 3/16", 2 mm, 2.5 mm, 3 mm, 4 mm, 5 mm	T7, T8, T10, T15, T20, T25, T27, T30, T40	Spanner: 4, 6, 8, 10; Tri-Wing®: 1, 2; TORQ-SET®: 6, 8, 10	3.5" (88.9 mm)	Yellow/Black	8" (203.2 mm)	0.71 lb (0.32 kg)

Replacement Bits

Cat. No.	Nut Driver Sizes	Phillips Bits	Slotted Bits	Square Bits	Hex Bits	TORX® Bits	Other Bits	Shank Length	Handle Color	Overall Length	Weight
32526	—	#0, #1, #2, #3	3-4, 5-6, 6-8, 8-10, 10-12, 12-14 Screw Sizes	#1, #2, #3	2mm, 3/32", 7/64", 1/8", 9/64", 4mm, 3/16"	T6, T7, T8, T10, T15, T20, T25	Clutch: 5/32" (4 mm), 3/16" (4.8 mm)	—	—	1" (25.4 mm)	0.43 lb (0.20 kg)
32525	—	—	—	—	5/64" (2 mm), 3/32" (2.4 mm), 7/64" (2.8 mm), 1/8" (3.2 mm), 9/64" (3.6 mm), 5/32" (4.0 mm), 3/16" (4.8 mm), 2 mm, 2.5 mm, 3 mm, 4 mm, 5 mm	T7, T8, T10, T15, T20, T25, T27, T30, T40	Spanner: 4, 6, 8, 10; Tri-Wing®: 1, 2, 3, 4	—	—	1" (25.4 mm)	0.43 lb (0.20 kg)

TORX® is a registered trademark of Acument Intellectual Properties, LLC. TORQ-SET® and Tri-Wing® are registered trademarks of Phillips Screw Co.

See page 297 for additional information on warnings.



Additional and replacement bits can be found on page 60

Multi-Bit Screwdriver/Nut Driver Replacement Parts and Bits

Replacement Parts for Multi-Bit Screwdriver/Nut Drivers

- Precision-machined tips for exact fit into fastener



32398



32396



32397



32484



32478



32784



32781



13105

Cat. No.	Tip Type	For Use With	Package Quantity
32392	—	Heavy Duty (32557) and Ratcheting (32558)	1 Piece
32394	—	Heavy Duty (32557) and Ratcheting (32558)	2 Piece
32395	—	Extended Reach Drivers (32559 and 32560)	1 Piece
32396	—	Stubby Drivers (32561 and 32562)	1 Piece
32397	#2 Phillips; #1 Square	Heavy Duty (32557) and Ratcheting (32558)	2 Bits
32398	#1 Phillips; 1/4" (6.4 mm) Slotted	Heavy Duty (32557), Ratcheting (32558) and Stubby (32561)	2 Bits
32399	#2 Square; 3/16" (4.8 mm) Slotted	Heavy Duty (32557) and Ratcheting (32558)	2 Bits
32400	#1, #2 Phillips	Extended Reach (32559)	2 Bits
32401	3/16" (4.8 mm), 1/4" 6.4 mm) Slotted	Extended Reach (32559)	2 Bits
32410	#2 Square; #2 Phillips	Stubby Driver (32560)	2 Bits
32411	#1 Square; 1/4" (6.4 mm) Slotted	Stubby Driver (32560)	2 Bits
32412	#2 Phillips; 3/16" (4.8 mm) Slotted	Stubby Driver (32561)	2 Bits
32478	#1 Phillips; 3/16" (4.8 mm) Slotted	5-in-1 (32476)	1 Bit
32479	#2 Phillips; 9/32" (7.1 mm) Slotted	5-in-1 (32476)	1 Bit
32482	#1 Phillips; 3/16" (4.8 mm) Slotted	10-in-1, 11-in-1 and 10-Fold™	2 Bits
32483	#2 Phillips; 1/4" (6.4 mm) Slotted	10-in-1, 11-in-1 and 10-Fold™	2 Bits
32484	#1, #2 Square	10-in-1, 11-in-1 and 10-Fold™	2 Bits
67101	#2 Phillips; 3/16" (4.8 mm) Slotted	2-in-1 Rapi-Driv®, 10-in-1, 11-in-1 and 10-Fold	2 Bits
32540	TT7, TT8 TORX®	10-in-1, 11-in-1 and 10-Fold™ Multi-bit Drivers	2 Bits
32541	TT9, TT10 TORX®	10-in-1, 11-in-1 and 10-Fold™ Multi-bit Drivers	2 Bits
32542	TT15, TT20 TORX®	10-in-1, 11-in-1 and 10-Fold™ Multi-bit Drivers	2 Bits
32543	TT25, TT27 TORX®	10-in-1, 11-in-1 and 10-Fold™ Multi-bit Drivers	2 Bits
32544	T6, T7 TORX®	10-in-1, 11-in-1 and 10-Fold™ Multi-bit Drivers	2 Bits
32485	T10 and T15 TORX®	10-in-1, 11-in-1 and 10-Fold™	2 Bits
32545	T8, T10 TORX®	10-in-1, 11-in-1 and 10-Fold™ Multi-bit Drivers	2 Bits
32546	T25, T27 TORX®	10-in-1, 11-in-1 and 10-Fold™ Multi-bit Drivers	2 Bits
32547	3/32", 7/64" Hex	10-in-1, 11-in-1 and 10-Fold™ Multi-bit Drivers	2 Bits
32548	5/32", 3/16" Hex	10-in-1, 11-in-1 and 10-Fold™ Multi-bit Drivers	2 Bits
32549	1/6", 5/64" Hex	10-in-1, 11-in-1 and 10-Fold™ Multi-bit Drivers	2 Bits
32550	1/8", 9/64" Hex	10-in-1, 11-in-1 and 10-Fold™ Multi-bit Drivers	2 Bits
32551	0.9 mm, 1.3 mm Hex	10-in-1, 11-in-1 and 10-Fold™ Multi-bit Drivers	2 Bits
32552	1.5 mm, 2.0 mm Hex	10-in-1, 11-in-1 and 10-Fold™ Multi-bit Drivers	2 Bits
32553	2.5 mm, 3.0 mm Hex	10-in-1, 11-in-1 and 10-Fold™ Multi-bit Drivers	2 Bits
32554	4.0 mm, 5.0 mm Hex	10-in-1, 11-in-1 and 10-Fold™ Multi-bit Drivers	2 Bits
32752	#1, #2 Combo	Combo-Tip Multi-Tool (32505)	2 Bits
32528	Schrader® Valve Core Tool	All Klein Tools 2-in-1, 10-in-1, 11-in-1 and 10-Fold Screwdrivers	1 Bit
32770	#1, #2 Phillips	15-in-1 Screwdrivers (32290, 32291, 32292)	1 Bit
32771	#0, #3 Phillips	15-in-1 Screwdrivers (32290, 32291, 32292)	1 Bit
32772	#1, #2 Square	15-in-1 Screwdrivers (32290, 32291, 32292)	1 Bit
32773	T10, T15 TORX®	15-in-1 Screwdrivers (32290, 32291, 32292)	1 Bit
32774	T20, T25 TORX®	15-in-1 Screwdrivers (32290, 32291, 32292)	1 Bit
32775	4 mm, 6 mm Slotted	15-in-1 Screwdrivers (32290, 32291, 32292)	1 Bit
32776	#1, #2 Combo	15-in-1 Screwdrivers (32290, 32291, 32292)	1 Bit
32777	6, 8 Spanner	15-in-1 Screwdrivers (32290, 32291, 32292)	1 Bit
32778	10, 12 Spanner	15-in-1 Screwdrivers (32290, 32291, 32292)	1 Bit
32779	1/8, 9/64 Hex Pin	15-in-1 Screwdrivers (32290, 32291, 32292)	1 Bit
32780	5/32, 3/16 Hex Pin	15-in-1 Screwdrivers (32290, 32291, 32292)	1 Bit
32781	10, 15 Tamperproof	15-in-1 Tamperproof Screwdriver (32291)	1 Bit
32782	20, 25 Tamperproof	15-in-1 Tamperproof Screwdriver (32291)	1 Bit
32783	27, 30 Tamperproof	15-in-1 Tamperproof Screwdriver (32291)	1 Bit
32784	Schrader® Valve Core Tool	15-in-1 HVAC Screwdriver (32292)	1 Bit
13391	#0 Phillips; 3/32" (2.4 mm) Slotted	4-in-1 Electronics Screwdriver (32581, 32585)	2 Bits
13392	#00 Phillips; 1/8" (3.2 mm) Slotted	4-in-1 Electronics Screwdriver (32581, 32585)	2 Bits
13104	T7, T10 Tamperproof TORX®	4-in-1 Electronics Screwdrivers (32581, 32585)	2 Bits
13105	T8, T15 TORX®	4-in-1 Electronics Screwdrivers (32581, 32585)	2 Bits
13231	Schrader® Valve Core Tool; 1/8" (3.2 mm) Slotted	HVAC 8-in-1 Slide Driver™ Screwdriver/Nut Driver (32596) and 11-in-1 Multi-bit Screwdriver (Cat. No. 32527)	1 Bit



Screwdrivers, Nut Drivers and Accessories

Meets or exceeds applicable ASME / ANSI and MIL specifications

Plastic-Handle Screwdrivers

Nickel-chrome, precision-forged and polished blades with black tips

Tough amber plastic handle

Smooth Comfordome® handles fit the palm of the hand comfortably

Chrome-plated shank helps prevent corrosion

Internal flanges provide solid, twist-resistant shaft anchor



Plastic-Handle Screwdrivers

Includes core Plastic-Handle Screwdriver features plus:

- Precision-machined Phillips tips provide a more consistent geometric symmetry to ensure accurate fit and torque without slippage
- Small-diameter cabinet-tip shanks for use in recessed holes or tight places and is well-suited for electrical and telecommunications work
- 35% larger than comparable screwdriver handles, the oversized Bull Driver handles deliver up to 50% extra power to perform tough jobs with minimal effort



Cat. No.	Tip Type	Shank Type	Shank Length	Overall Length	Weight
P18	#1 Phillips	Round	8" (203.2 mm)	11.5" (292.1 mm)	2.4 oz (68 g)
P28	#2 Phillips	Round	8" (203.2 mm)	11.625" (295.3 mm)	3.2 oz (91 g)
P212	#2 Phillips	Round	12" (304.8 mm)	15.625" (396.9 mm)	4.0 oz (113 g)
P202	#2 Phillips	Round	20" (508.0 mm)	24.5" (622.3 mm)	8.8 oz (249 g)
A000	3/32" (2.4 mm) Keystone	Round	1.5" (38.1 mm)	2.875" (73 mm)	0.32 oz (9 g)
A216-3	1/8" (3.2 mm) Cabinet	Round	3" (76.2 mm)	6" (152.4 mm)	0.8 oz (23 g)
A216-4	1/8" (3.2 mm) Cabinet	Round	4" (101.6 mm)	7" (177.8 mm)	0.8 oz (23 g)
A216-6	1/8" (3.2 mm) Cabinet	Round	6" (152.4 mm)	9" (228.6 mm)	0.8 oz (23 g)
A216-8	1/8" (3.2 mm) Cabinet	Round	8" (203.2 mm)	11" (279.4 mm)	0.8 oz (23 g)
A216-10	1/8" (3.2 mm) Cabinet	Round	10" (254.0 mm)	13" (330.2 mm)	0.8 oz (23 g)
A316-4	3/16" (4.8 mm) Cabinet	Round	4" (101.6 mm)	7.625" (193.7 mm)	1.6 oz (45 g)
A316-6	3/16" (4.8 mm) Cabinet	Round	6" (152.4 mm)	9.625" (244.5 mm)	1.6 oz (45 g)
A316-8	3/16" (4.8 mm) Cabinet	Round	8" (203.2 mm)	11.625" (295.3 mm)	2.4 oz (68 g)
A316-10	3/16" (4.8 mm) Cabinet	Round	10" (254.0 mm)	13.625" (346.1 mm)	3.2 oz (91 g)
70155	3/16" (4.8 mm) Cabinet	Round	20" (508.0 mm)	24.5" (622.3 mm)	7.2 oz (204 g)

Bull Driver™ Plastic Handle Screwdrivers

BD284	1/4" (6.4 mm) Keystone	Square	4" (101.6 mm)	8.5" (215.9 mm)	4.0 oz (113 g)
BD306	5/16" (7.9 mm) Keystone	Square	6" (152.4 mm)	11.188" (284.2 mm)	5.6 oz (159 g)
BD308	5/16" (7.9 mm) Keystone	Square	8" (203.2 mm)	13.188" (335 mm)	6.4 oz (181 g)
BD410	3/8" (9.5 mm) Keystone	Square	10" (254.0 mm)	15.188" (385.8 mm)	9.6 oz (272 g)
BD412	3/8" (9.5 mm) Keystone	Square	12" (304.8 mm)	17.188" (436.6 mm)	12.0 oz (340 g)
BD144	1/4" (6.4 mm) Keystone	Round	4" (101.6 mm)	8.5" (215.9 mm)	4.0 oz (113 g)
BD146	1/4" (6.4 mm) Keystone	Round	6" (152.4 mm)	10.5" (266.7 mm)	4.0 oz (113 g)
BD156	5/16" (7.9 mm) Keystone	Round	6" (152.4 mm)	11.188" (284.2 mm)	5.6 oz (159 g)
BD408	3/8" (9.5 mm) Keystone	Round	8" (203.2 mm)	13.188" (335 mm)	8 oz (227 g)
BD111	#1 Phillips	Round	3" (76.2 mm)	6.625" (168.3 mm)	1.6 oz (45 g)
BD122	#2 Phillips	Round	4" (101.6 mm)	8.5" (215.9 mm)	3.2 oz (91 g)
BD133	#3 Phillips	Round	6" (152.4 mm)	11.188" (284.2 mm)	5.6 oz (159 g)

Cat. No.	Set Contains	Weight
85276	7 Piece Combination Screwdriver Set	1.1 lb (0.5 kg)

Cat. No. Description

BD284	1/4" Keystone Screwdriver 4" Square Shank
BD306	5/16" Keystone Screwdriver 6" Shank
A216-3	1/8" Cabinet Tip Screwdriver 3" Shank
A216-4	1/8" Cabinet Screwdriver 4" Round Shank
A216-6	Screwdriver, 1/8" Cabinet Tip, 6"
BD111	#1 Profilated Phillips Screwdriver, 3" Shank
BD122	Profilated #2 Phillips Screwdriver 4"

See page 297 for additional information on warnings.



Plastic-Handle Screwdrivers

Pocket-Clip Screwdrivers

Includes core Plastic-Handle Screwdriver features plus:

- Specially designed for delicate instrument work



A116-3



Cat. No.	Tip Type	Shank Type	Shank Length	Overall Length	Weight
A130-2	1/8" (3.2 mm) Keystone	Round	2" (50.8 mm)	3.875" (98.4 mm)	0.8 oz (23 g)
A130-3	1/8" (3.2 mm) Keystone	Round	3" (76.2 mm)	4.875" (123.8 mm)	0.6 oz (17 g)
A116-2	3/32" (2.4 mm) Keystone	Round	2" (50.8 mm)	4.438" (112.7 mm)	0.8 oz (23 g)
A116-3	3/32" (2.4 mm) Keystone	Round	3" (76.2 mm)	5.438" (138.1 mm)	0.5 oz (14 g)
A131-2	1/8" (3.2 mm) Keystone	Round	2" (50.8 mm)	4.438" (112.7 mm)	0.8 oz (23 g)
P12	#0 Phillips	Round	2.5" (63.5 mm)	5" (127.0 mm)	0.8 oz (23 g)

Magnetic Plastic-Handle Screwdriver

- Powerful magnet built into its shank to hold interchangeable bits and also screws
- Comfortable handle for easier driving
- Interchangeable bits store inside handle for quick access
- Wide selection of bits for different screw types



70035

Cat. No.	Phillips Bits	Slotted Bits	Shank Length	Handle Color	Overall Length	Weight
70035	#1, #2	3/16" (4.8 mm), 9/32" (7.1 mm)	3.75" (95.3 mm)	Black and Clear	3.438" (87.3 mm)	0.25 lb (0.11 kg)

Slotted Plastic-Handle Screw-Holding Screwdrivers

- Positive gripping action holds, starts, and drives slotted screws in awkward, hard-to-reach places
- Split-blade screw-holding driver wedges into screw slot
- Not designed for torquing or tightening



K36

Cat. No.	Tip Type	Shank Type	Overall Length	Weight
K23	3/16" (4.8 mm) Slotted	Round	5.25" (133.4 mm)	0.80 oz (22.7 g)
K28	3/16" (4.8 mm) Slotted	Round	10.25" (260.4 mm)	0.10 lb (0.05 kg)
K34	1/4" (6.4 mm) Slotted	Round	7.75" (196.9 mm)	0.10 lb (0.05 kg)
K36	1/4" (6.4 mm) Slotted	Round	9.75" (247.7 mm)	0.15 lb (0.07 kg)
K38	1/4" (6.4 mm) Slotted	Round	11.75" (298.5 mm)	0.20 lb (0.09 kg)
K44	5/16" (7.9 mm) Slotted	Round	8.25" (209.6 mm)	0.25 lb (0.11 kg)
K46	5/16" (7.9 mm) Slotted	Round	10.25" (260.4 mm)	0.25 lb (0.11 kg)
K48	5/16" (7.9 mm) Slotted	Round	12.25" (311.2 mm)	0.30 lb (0.14 kg)

Cat. No.	Set Contains	Weight
SK234	Slotted Holding Screwdriver Set 3 Pc	0.40 lb (0.18 kg)

Cat. No.	Description
K23	3/16" Screw Holding Screwdriver, 3"
K34	Slotted Screw Holding Screwdriver 4"
K46	5/16" Slotted Holding Screwdriver, 6"

Precision blade for use with small precision screws. Blade thickness of 0.028" expanding to 0.045".
 ‡ Blade thickness of 0.043" expanding to 0.085". K21 and K23 have pocket clips.



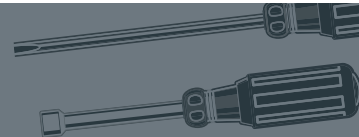

Screw-Holding Screwdrivers

Phillips-Tip Screw-Holding Screwdrivers

- Positive gripping action holds and starts Phillips screws in awkward, hard-to-reach places
- Blade separates to hold the fastener
- Not designed for torquing or tightening



K16



Cat. No.	Tip Type	Shank Type	Overall Length	Weight
K14	Phillips	Round	5" (127.0 mm)	0.80 oz (22.7 g)
K16	Phillips	Round	7" (177.8 mm)	0.80 oz (22.7 g)
K19	Phillips	Round	9" (228.6 mm)	0.80 oz (22.7 g)

Impact and Torque Drivers

Reversible Impact-Driver Set

- Rugged, hand-impact driver turns rusted, frozen, or other stubborn screws
- Can also be used with 3/8" square-drive impact sockets
- Internal, spring-loaded, helical design transforms the impact of a hammer blow to up to 200 ft.-lbs. of shock torque
- Easily reverses for tightening or loosening screws
- Constructed of high-grade alloy steel that has been heat-treated for added strength
- Reclosable, seal-tight vinyl pouch with hang-up grommet



BITS FOR IMPACT DRIVER SET 70229



70220



Cat. No.	Phillips Bits	Nut Driver Sizes	Slotted Bits	Included	Weight
70220	#2 and #4	5/16"	5/16" (7.9 mm) and 1/2" (12.7 mm)	3/8" (9.5 mm) Square Drive fitting Adapter	2.2 lb (1.0 kg)

Torque Screwdriver Set

- Compact, easy to use set includes the Torque Screwdriver, a 6-piece bit set and a rugged case with foam inserts for a tight, organized fit
- Increased usability and readability plus a wider torque range (5-40 in. lbs)
- Tri-lobular design with a textured finish for better grip
- Lightweight, aluminum frame
- N.I.S.T. traceable calibration certificate
- Set includes six 3-1/2" (89 mm) power drivers and a 1/4" nut driver



57032



Cat. No.	Included	Weight
57032	Phillips: #1 and #2; Slotted: 3/16" (4.8 mm) and 1/4" (6.4 mm); Square: #1 and #2 and 1/4" Nut Driver	1.0 lb (0.5 kg)

See page 297 for additional information on warnings.



Heavy-Duty Cushion-Grip Nut Drivers

Through-handle full-hollow shaft

design for torquing hex nuts onto threaded rod of any length



Wrench-assist
feature for
added torque



**Rare-earth
magnetic tip**
holds nut in
place while
fastening



**Color-coded
ends and tips**
for easy size
identification

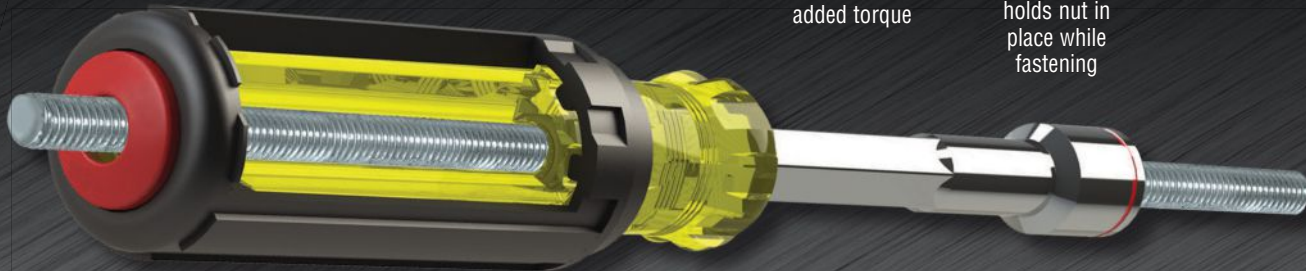

6 sizes 1/4", 5/16", 3/8",
7/16", 1/2" and 9/16" sizes



**MADE IN
USA**
GLOBAL
COMPONENTS

Heavy-Duty Nut Drivers



635-1/4



635-5/16



635-3/8



635-7/16



635-1/2



635-9/16



Cat. No.	Nut Driver Sizes	Shaft Length	Color Code	Overall Length	Weight
635-1/4	1/4"	4" (101.6 mm)	Red	9" (228.6 mm)	0.30 lb (0.14 kg)
635-5/16	5/16"	4" (101.6 mm)	Yellow	9" (228.6 mm)	0.30 lb (0.14 kg)
635-3/8	3/8"	4" (101.6 mm)	Blue	9" (228.6 mm)	0.30 lb (0.14 kg)
635-7/16	7/16"	4" (101.6 mm)	Brown	9.391" (238.5 mm)	0.40 lb (0.18 kg)
635-1/2	1/2"	4" (101.6 mm)	Red	9.391" (238.5 mm)	0.50 lb (0.23 kg)
635-9/16	9/16"	4" (101.6 mm)	Orange	9.391" (238.5 mm)	0.50 lb (0.23 kg)

Cat. No.	Set Contains	Weight
635-6	Heavy-Duty Nut Driver Set, 6-Piece	2.5 lb (1.1 kg)
Cat. No.	Description	
635-1/4	1/4" Nut Driver, Magnetic Tip, 4" Shaft	
635-5/16	Heavy-Duty Nut Driver, 5/16"	
635-3/8	3/8" Heavy-Duty Nut Driver	
635-7/16	7/16" Heavy-Duty Nut Driver	
635-1/2	1/2" Heavy-Duty Nut Driver	
635-9/16	9/16" Heavy-Duty Nut Driver	

Cat. No.	Set Contains	Weight
635-4	Heavy-Duty Nut Driver Set, 4-Piece	1.4 lb (0.6 kg)
Cat. No.	Description	
635-1/4	1/4" Nut Driver, Magnetic Tip, 4" Shaft	
635-5/16	Heavy-Duty Nut Driver, 5/16"	
635-3/8	3/8" Heavy-Duty Nut Driver	
635-7/16	7/16" Heavy-Duty Nut Driver	



Cushion-Grip Nut Drivers

Meets or exceeds applicable ASME / ANSI and MIL specifications



Handle end is also color coded for easy identification

Tip-Ident® quickly identifies nut driver and size

MADE IN USA

Magnetic-Tip Hollow-Shaft Nut Drivers

Includes core Cushion-Grip Nut Driver features plus:

- Exclusive hollow shaft* design with Rare Earth magnetic tip features unobstructed pass-through, even on long bolts



630-3/8M

Cat. No.	Nut Driver Sizes	Shaft Length	Color Code	Overall Length	Weight
610-1/4M	1/4"	1.5" (38.1 mm)	Red	3.5" (88.9 mm)	0.10 lb (0.05 kg)
610-5/16M	5/16"	1.5" (38.1 mm)	Yellow	3.5" (88.9 mm)	0.10 lb (0.05 kg)
630-3/16M	3/16"	3" (76.2 mm)	Black	6.75" (171.5 mm)	0.20 lb (0.09 kg)
630-1/4M	1/4"	3" (76.2 mm)	Red	6.75" (171.5 mm)	0.20 lb (0.09 kg)
630-5/16M	5/16"	3" (76.2 mm)	Yellow	6.75" (171.5 mm)	0.20 lb (0.09 kg)
630-11/32M	11/32"	3" (76.2 mm)	Green	6.75" (171.5 mm)	0.20 lb (0.09 kg)
630-3/8M	3/8"	3" (76.2 mm)	Blue	6.75" (171.5 mm)	0.20 lb (0.09 kg)
630-7/16M	7/16"	3" (76.2 mm)	Brown	7.313" (185.8 mm)	0.25 lb (0.11 kg)
630-1/2M	1/2"	3" (76.2 mm)	Red	7.313" (185.8 mm)	0.25 lb (0.11 kg)
646-3/16M	3/16"	6" (152.4 mm)	Black	9.75" (247.7 mm)	0.25 lb (0.11 kg)
646-1/4M	1/4"	6" (152.4 mm)	Red	9.75" (247.7 mm)	0.25 lb (0.11 kg)
646-5/16M	5/16"	6" (152.4 mm)	Yellow	9.75" (247.7 mm)	0.25 lb (0.11 kg)
646-11/32M	11/32"	6" (152.4 mm)	Green	9.75" (247.7 mm)	0.25 lb (0.11 kg)
646-3/8M	3/8"	6" (152.4 mm)	Blue	9.75" (247.7 mm)	0.30 lb (0.14 kg)
646-7/16M	7/16"	6" (152.4 mm)	Brown	10.313" (262 mm)	0.35 lb (0.16 kg)
646-1/2M	1/2"	6" (152.4 mm)	Red	10.313" (262 mm)	0.35 lb (0.16 kg)
618-1/4M	1/4"	18" (457.2 mm)	Red	21.75" (552.5 mm)	0.50 lb (0.23 kg)
618-5/16M	5/16"	18" (457.2 mm)	Yellow	21.75" (552.5 mm)	0.50 lb (0.23 kg)

*3/16" magnetic nut driver does not have a hollow shaft.

Cat. No.	Set Contains	Weight
631M	Magnetic Nut Driver Set 3" Shaft, 7 Pc	1.5 lb (0.7 kg)
	Cat. No. Description	
630-3/16M	3/16" Magnetic Tip Nut Driver 3" Shaft	
630-1/4M	1/4" Magnetic Tip Nut Driver 3" Shaft	
630-5/16M	5/16" Nut Driver with Hollow Shaft	
630-11/32M	11/32" Magnetic Tip Nut Driver, 3" Shaft	
630-3/8M	3/8" Magnetic Tip Nut Driver	
630-7/16M	7/16" Magnetic Tip Nut Driver 3" Shaft	
630-1/2M	Nut Driver, 1/2" Magnetic Tip, 3" Shaft	
647M	Magnetic Nut Driver Set, 6" Shafts, 7-Piece	1.5 lb (0.7 kg)
	Cat. No. Description	
646-3/16M	3/16" Magnetic Nut Driver, 6" Shaft	
646-1/4M	1/4" Magnetic Tip Nut Driver 6" Shaft	
646-5/16M	5/16" Magnetic Nut Driver Cushion-Grip	
646-11/32M	11/32" Magnetic Nut Driver 6" Hollow Shaft	
646-3/8M	3/8" Magnetic Tip Nut Driver 6" Shaft	
646-7/16M	7/16" Magnetic Tip Nut Driver 6" Shaft	
646-1/2M	1/2" Magnetic Tip Nut Driver 6" Shaft	
630M	Magnetic Nut Driver Set 3" Shank 2-Piece	0.40 lb (0.18 kg)
	Cat. No. Description	
630-1/4M	1/4" Magnetic Tip Nut Driver 3" Shaft	
630-5/16M	5/16" Nut Driver with Hollow Shaft	
646M	Nut Driver Set 6" Shafts, Magnetic 2 Pc	0.50 lb (0.23 kg)
	Cat. No. Description	
646-1/4M	1/4" Magnetic Tip Nut Driver 6" Shaft	
646-5/16M	5/16" Magnetic Nut Driver Cushion-Grip	
610M	Stubby Nut Driver Set 1-1/2" Shafts Magnetic 2 Pc	0.20 lb (0.09 kg)
	Cat. No. Description	
610-1/4M	1/4" Hollow Magnetic Nut Driver, 1-1/2"	
610-5/16M	5/16" Magnetic Nut Driver, 1-1/2" Shaft	

See page 297 for additional information on warnings.



Cushion-Grip Nut Drivers

Hollow-Shaft Nut Drivers

Includes core Cushion-Grip Nut Driver features plus:

- 3" (76 mm) length for most long bolt and stud applications
- 6" (152 mm) length reaches into deep recesses and fits over extra-long bolts and studs
- Exclusive hollow shaft* design with Rare Earth magnetic tip features unobstructed pass-through, even on long bolts

Refer to the insulated section for insulated nut drivers.

Cat. No.	Nut Driver Sizes	Shaft Length	Color Code	Overall Length	Weight
610-1/4	1/4"	1.5" (38.1 mm)	Red	3.5" (88.9 mm)	0.10 lb (0.05 kg)
610-5/16	5/16"	1.5" (38.1 mm)	Yellow	3.5" (88.9 mm)	0.10 lb (0.05 kg)
630-3/16	3/16"	3" (76.2 mm)	Black	6.75" (171.5 mm)	0.20 lb (0.09 kg)
630-1/4	1/4"	3" (76.2 mm)	Red	6.75" (171.5 mm)	0.20 lb (0.09 kg)
630-5/16	5/16"	3" (76.2 mm)	Yellow	6.75" (171.5 mm)	0.20 lb (0.09 kg)
630-11/32	11/32"	3" (76.2 mm)	Green	6.75" (171.5 mm)	0.20 lb (0.09 kg)
630-3/8	3/8"	3" (76.2 mm)	Blue	6.75" (171.5 mm)	0.20 lb (0.09 kg)
630-7/16	7/16"	3" (76.2 mm)	Brown	7.313" (185.8 mm)	0.25 lb (0.11 kg)
630-1/2	1/2"	3" (76.2 mm)	Red	7.313" (185.8 mm)	0.25 lb (0.11 kg)
630-9/16	9/16"	4" (101.6 mm)	Orange	9.375" (238.1 mm)	0.35 lb (0.16 kg)
630-5/8	5/8"	4" (101.6 mm)	Yellow	9.375" (238.1 mm)	0.35 lb (0.16 kg)
646-3/16	3/16"	6" (152.4 mm)	Black	9.75" (247.7 mm)	0.25 lb (0.11 kg)
646-1/4	1/4"	6" (152.4 mm)	Red	9.75" (247.7 mm)	0.25 lb (0.11 kg)
646-5/16	5/16"	6" (152.4 mm)	Yellow	9.75" (247.7 mm)	0.25 lb (0.11 kg)
646-11/32	11/32"	6" (152.4 mm)	Green	9.75" (247.7 mm)	0.25 lb (0.11 kg)
646-3/8	3/8"	6" (152.4 mm)	Blue	9.75" (247.7 mm)	0.30 lb (0.14 kg)
646-7/16	7/16"	6" (152.4 mm)	Brown	10.313" (262 mm)	0.35 lb (0.16 kg)
646-1/2	1/2"	6" (152.4 mm)	Red	10.313" (262 mm)	0.35 lb (0.16 kg)
646-9/16	9/16"	6" (152.4 mm)	Orange	11.375" (288.9 mm)	0.40 lb (0.18 kg)
646-5/8	5/8"	6" (152.4 mm)	Yellow	11.375" (288.9 mm)	0.40 lb (0.18 kg)
Metric					
630-4MM	4 mm	3" (76.2 mm)	Red	6.75" (171.5 mm)	0.20 lb (0.09 kg)
630-4.5MM	4.5 mm	3" (76.2 mm)	Yellow	6.75" (171.5 mm)	0.20 lb (0.09 kg)
630-5MM	5 mm	3" (76.2 mm)	Black	6.75" (171.5 mm)	0.20 lb (0.09 kg)
630-6MM	6 mm	3" (76.2 mm)	Red	6.75" (171.5 mm)	0.20 lb (0.09 kg)
630-7MM	7 mm	3" (76.2 mm)	Orange	6.75" (171.5 mm)	0.20 lb (0.09 kg)
630-8MM	8 mm	3" (76.2 mm)	Yellow	6.75" (171.5 mm)	0.20 lb (0.09 kg)
630-10MM	10 mm	3" (76.2 mm)	Blue	6.75" (171.5 mm)	0.20 lb (0.09 kg)
630-11MM	11 mm	3" (76.2 mm)	Brown	7.313" (185.8 mm)	0.20 lb (0.09 kg)



630-11MM

Cat. No.	Set Contains	Weight
631	Nut Driver Set 3" Shafts, 7 Piece	1.5 lb (0.7 kg)

Cat. No.	Description
630-3/16	3/16" Nut Driver with 3" Hollow Shaft
630-1/4	1/4" Nut Driver 3" Shaft Cushion Grip
630-5/16	5/16" Nut Driver Cushion-Grip 3" Shaft
630-11/32	11/32" Nut Driver 3" Hollow Shaft
630-3/8	3/8" Nut Driver with 3" Hollow Shaft
630-7/16	7/16" Hollow Nut Driver, 3", Cushion-Grip
630-1/2	1/2" Nut Driver, 3" Shaft, Cushion-Grip

Cat. No.	Set Contains	Weight
647	Nut Driver Set 6" Shafts, 7 Piece	1.7 lb (0.8 kg)

Cat. No.	Description
646-3/16	3/16" Nut Driver with 6" Hollow Shaft
646-1/4	1/4" Nut Driver with 6" Hollow Shaft
646-5/16	5/16" Nut Driver, 6" Hollow Shaft
646-11/32	11/32" Nut Driver 6" Hollow Shaft
646-3/8	3/8" Nut Driver, 6" Hollow Shaft
646-7/16	7/16" Nut Driver, 6" Hollow Shaft
646-1/2	1/2" Nut Driver with 6" Hollow Shaft

Cat. No.	Set Contains	Weight
65160	Nut Driver Set, Metric, 3" Shafts, 7-Piece	1.5 lb (0.7 kg)

Cat. No.	Description
630-5MM	5 mm Nut Driver, 3" Hollow Shaft
630-55MM	5.5 mm Cushion-Grip Hollow-Shank Nut Driver
630-6MM	6 mm Nut Driver, 3" Hollow Shaft, Cushion Grip
630-7MM	7 mm Cushion Grip Nut Driver with 3" Shaft
630-8MM	8 mm Nut Driver, Cushion Grip, 3" Hollow Shaft
630-9MM	9 mm Cushion-Grip Nut Driver, 3" Hollow Shaft
630-10MM	10mm Cushion Grip Nut Driver with 3" Shaft

Cat. No.	Set Contains	Weight
633	Nut Driver Set, Cushion Grip, 4-Piece	1.3 lb (0.6 kg)

Cat. No.	Description
630-1/4	1/4" Nut Driver 3" Shaft Cushion Grip
630-5/16	5/16" Nut Driver Cushion-Grip 3" Shaft
630-3/8	3/8" Nut Driver with 3" Hollow Shaft
630-9/16	9/16" Hollow Shaft Nut Driver 4" Shaft

Cat. No.	Set Contains	Weight
610	Stubby Nut Driver Set 1-1/2" Shafts 2 Pc	0.20 lb (0.09 kg)

Cat. No.	Description
610-1/4	1/4" Stubby Nut Driver with 1-1/2" Shaft
610-5/16	5/16" Stubby Nut Driver, 1-1/2" Shaft



Cushion-Grip Multi-Nut Drivers

Solid build quality with nut drivers that exceed the standard torque performance



Wrench-assist feature for added torque



ASSEMBLED
IN
USA



Cushion-Grip handle for greater torque and comfort

Hollow-shafts accommodate long bolts

Color-coded bands for easy identification

Heavy-Duty Multi-Nut Drivers

- Multiple sizes in one convenient tool
- Heavy-duty handle and shaft exceed the torque performance of regular nut drivers
- Wrench-assist feature for added torque
- Strong, rare earth magnets securely hold nuts and bolts (Cat. No. 32807MAG)



32807MAG



32800

Cat. No.	Description	Nut Driver Sizes	Shaft Length	Overall Length	Weight
NEW 32807MAG	7-in-1 Nut Driver	1/4", 5/16", 11/32", 3/8", 1/2", 7/16", 9/16"		9.54" (242.3 mm)	1.12 lb (0.51 kg)
32800	6-in-1 Multi-Nut Driver Heavy Duty	3/16", 1/4", 5/16", 3/8", 7/16", 9/16"	4" (101.6 mm)	9.5" (241.3 mm)	1.2 lb (0.5 kg)
32801	5-in-1 Multi-Nut Driver Heavy Duty	3/16", 1/4", 5/16", 3/8", 9/16"	4" (101.6 mm)	9.109" (231.4 mm)	1.0 lb (0.5 kg)

Specialty Cushion-Grip Nut Drivers

Coated Hollow-Shaft Nut Drivers

Includes core Cushion-Grip Nut Driver features plus:

- Entire shaft plastic coated for circuit protection only. NOT INSULATED
- Special plastic coating resists cutting, cracking and chipping
- Thin coating permits use in confined areas



640-1/2

Cat. No.	Nut Driver Sizes	Shaft Length	Color Code	Overall Length	Weight
640-3/16	3/16"	3" (76.2 mm)	Black	6.75" (171.5 mm)	0.25 lb (0.11 kg)
640-1/4	1/4"	3" (76.2 mm)	Red	6.75" (171.5 mm)	0.25 lb (0.11 kg)
640-5/16	5/16"	3" (76.2 mm)	Yellow	6.75" (171.5 mm)	0.25 lb (0.11 kg)
640-3/8	3/8"	3" (76.2 mm)	Blue	6.75" (171.5 mm)	0.25 lb (0.11 kg)
640-7/16	7/16"	3" (76.2 mm)	Brown	7.313" (185.8 mm)	0.30 lb (0.14 kg)
640-1/2	1/2"	3" (76.2 mm)	Red	7.313" (185.8 mm)	0.25 lb (0.11 kg)
640-9/16	9/16"	4" (101.6 mm)	Orange	9.375" (238.1 mm)	0.40 lb (0.18 kg)
640-5/8	5/8"	4" (101.6 mm)	Yellow	9.375" (238.1 mm)	0.40 lb (0.18 kg)

WARNING: NOT insulated. Coating is intended for protection of circuits only.

See page 297 for additional information on warnings.



Plastic-Handle Nut Drivers

Meets or exceeds applicable ASME / ANSI and MIL specifications.

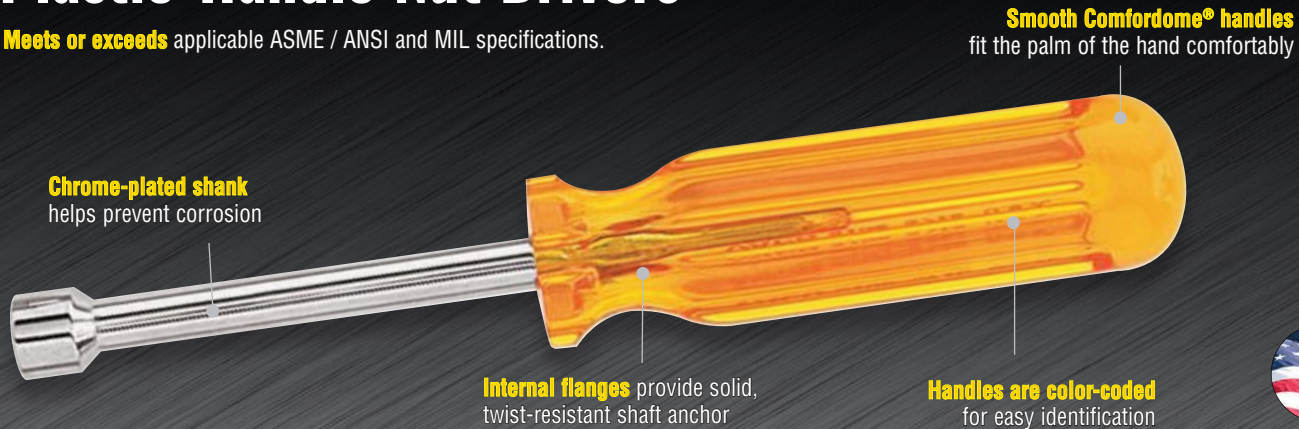

Hollow-Shaft Nut Drivers

Includes core Plastic-Handle Nut Driver features plus:

- Standard length works for most applications
- Fits over long bolts and studs
- Cat. Nos. SS8, SS10 and SS12 have smaller shaft length for work in close quarters



S11



Cat. No.	Nut Driver Sizes	Shaft Length	Handle Color	Overall Length	Weight
SS8	1/4"	1.5" (38.1 mm)	Red	3.75" (95.3 mm)	0.15 lb (0.07 kg)
SS10	5/16"	1.5" (38.1 mm)	Amber	3.75" (95.3 mm)	0.15 lb (0.07 kg)
SS12	3/8"	1.5" (38.1 mm)	Blue	3.75" (95.3 mm)	0.15 lb (0.07 kg)
S5	5/32"	3" (76.2 mm)	Amber	6.5" (165.1 mm)	0.10 lb (0.05 kg)
S6	3/16"	3" (76.2 mm)	Black	6.625" (168.3 mm)	0.10 lb (0.05 kg)
S7	7/32"	3" (76.2 mm)	Brown	6.625" (168.3 mm)	0.10 lb (0.05 kg)
S8	1/4"	3" (76.2 mm)	Red	6.625" (168.3 mm)	0.15 lb (0.07 kg)
S9	9/32"	3" (76.2 mm)	Orange	6.625" (168.3 mm)	0.15 lb (0.07 kg)
S10	5/16"	3" (76.2 mm)	Amber	6.625" (168.3 mm)	0.15 lb (0.07 kg)
S11	11/32"	3" (76.2 mm)	Green	6.625" (168.3 mm)	0.15 lb (0.07 kg)
S12	3/8"	3" (76.2 mm)	Blue	6.625" (168.3 mm)	0.15 lb (0.07 kg)
S14	7/16"	3" (76.2 mm)	Brown	7" (177.8 mm)	0.20 lb (0.09 kg)
S16	1/2"	3" (76.2 mm)	Red	7" (177.8 mm)	0.20 lb (0.09 kg)
S18	9/16"	4" (101.6 mm)	Red	8.5" (215.9 mm)	0.30 lb (0.14 kg)
S20	5/8"	4" (101.6 mm)	Red	8.5" (215.9 mm)	0.30 lb (0.14 kg)
S66	3/16"	6" (152.4 mm)	Black	9.625" (244.5 mm)	0.15 lb (0.07 kg)
S86	1/4"	6" (152.4 mm)	Red	9.625" (244.5 mm)	0.15 lb (0.07 kg)
S106	5/16"	6" (152.4 mm)	Amber	9.625" (244.5 mm)	0.15 lb (0.07 kg)
S116	11/32"	6" (152.4 mm)	Green	9.625" (244.5 mm)	0.15 lb (0.07 kg)
S126	3/8"	6" (152.4 mm)	Blue	9.625" (244.5 mm)	0.15 lb (0.07 kg)
S146	7/16"	6" (152.4 mm)	Brown	10" (254.0 mm)	0.20 lb (0.09 kg)
S166	1/2"	6" (152.4 mm)	Red	10" (254.0 mm)	0.20 lb (0.09 kg)

Cat. No.	Set Contains	Weight
K7	Nut Driver Set, 3" Shafts, 7-Piece	1.2 lb (0.5 kg)

Cat. No.	Description
S6	3/16" Nut Driver, 3" Hollow Shaft
S8	1/4" Hollow Shaft Nut Driver, 3" Shaft
S10	5/16" Nut Driver 3" Hollow Shaft
S11	11/32" Nut Driver, 3" Hollow Shaft
S12	3/8" Nut Driver, 3" Hollow Shaft
S14	7/16" Nut Driver, 3" Hollow Shaft
S16	1/2" Nut Driver 3" Hollow Shaft

Cat. No.	Set Contains	Weight
89904	Nut Driver Set, 6" Shafts, 7-Piece	1.2 lb (0.5 kg)

Cat. No.	Description
S66	3/16" Nut Driver 6" Hollow Shaft
S86	1/4" Nut Driver, 6" Hollow Shaft
S106	5/16" Nut Driver, 6" Shaft
S116	11/32" Nut Driver, 6" Shaft
S126	3/8" Nut Driver, 6" Hollow Shaft
S146	7/16" Nut Driver, 6" Hollow Shaft
S166	1/2" Nut Driver, 6" Hollow Shaft

Set Cat. No. K7 includes a vinyl pouch which hangs up or rolls up



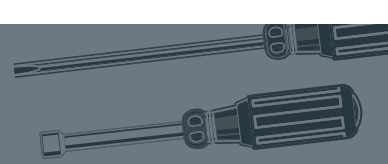

Plastic Handle, Hollow-Shaft Nut Drivers

Super-Long Nut Drivers - 18" (457 mm) Shafts

Includes core Plastic-Handle Nut Driver features plus:

- Ideal for reaching into walls and other hard-to-reach places where added length is necessary
- Cat. No. S1018 has a non-magnetic tip; Cat. Nos. S818M and S1018M have magnetic tips



S1018



Cat. No.	Nut Driver Sizes	Shaft Length	Handle Color	Overall Length	Weight
S1018	5/16"	18" (457.2 mm)	Amber	21.625" (549.3 mm)	0.25 lb (0.11 kg)
S818M	1/4"	18" (457.2 mm)	Red	21.625" (549.3 mm)	0.25 lb (0.11 kg)
S1018M	5/16"	18" (457.2 mm)	Amber	21.625" (549.3 mm)	0.25 lb (0.11 kg)

Metric Nut Drivers

Includes core Plastic-Handle Nut Driver features plus:

- Standard length works for most applications
- Fits over long bolts and studs



70209

Cat. No.	Nut Driver Sizes	Shaft Length	Handle Color	Overall Length	Weight
70204	4 mm	3" (76.2 mm)	Black	6.625" (168.3 mm)	0.10 lb (0.05 kg)
70245	4.5 mm	3" (76.2 mm)	Black	6.625" (168.3 mm)	0.10 lb (0.05 kg)
70205	5 mm	3" (76.2 mm)	Black	6.625" (168.3 mm)	0.15 lb (0.07 kg)
70255	5.5 mm	3" (76.2 mm)	Black	6.625" (168.3 mm)	0.15 lb (0.07 kg)
70206	6 mm	3" (76.2 mm)	Black	6.625" (168.3 mm)	0.15 lb (0.07 kg)
70207	7 mm	3" (76.2 mm)	Black	6.625" (168.3 mm)	0.15 lb (0.07 kg)
70208	8 mm	3" (76.2 mm)	Black	6.625" (168.3 mm)	0.15 lb (0.07 kg)
70209	9 mm	3" (76.2 mm)	Black	6.625" (168.3 mm)	0.15 lb (0.07 kg)
70210	10 mm	3" (76.2 mm)	Black	7" (177.8 mm)	0.15 lb (0.07 kg)
70211	11 mm	3" (76.2 mm)	Black	7" (177.8 mm)	0.20 lb (0.09 kg)

Cat. No.	Set Contains	Weight
70200	Metric Nut Driver Set 3" Shanks 10-Piece	1.9 lb (0.8 kg)

Cat. No. Description

70204	4 mm Metric Nut Driver 3" Shaft
70245	4.5 mm Metric Nut Driver 3" Shaft
70205	5 mm Metric Nut Driver 3" Shaft
70255	5.5 mm Metric Nut Driver 3" Hollow Shaft
70206	6 mm Metric Nut Driver 3" Shaft
70207	7 mm Metric Nut Driver 3" Shaft
70208	8 mm Metric Nut Driver 3" Shaft
70209	9 mm Metric Nut Driver 3" Shaft
70210	10 mm Metric Nut Driver, 3" Shaft
70211	11 mm Metric Nut Driver 3" Shaft

Set includes white enameled metal stand with identification labels for easy selection of tool

Plastic Handle Nut Drivers

Magnetic Nut Drivers - Solid Shafts

Includes core Plastic-Handle Nut Driver features plus:

- Powerful nut-holding magnet built into solid shaft



S818M



Cat. No.	Nut Driver Sizes	Shaft Length	Handle Color	Overall Length	Weight
S8M	1/4"	3" (76.2 mm)	Red	6.625" (168.3 mm)	0.15 lb (0.07 kg)
S10M	5/16"	3" (76.2 mm)	Amber	6.625" (168.3 mm)	0.15 lb (0.07 kg)
S86M	1/4"	6" (152.4 mm)	Yellow	9.625" (244.5 mm)	0.15 lb (0.07 kg)
S106M	5/16"	6" (152.4 mm)	Amber	9.625" (244.5 mm)	0.15 lb (0.07 kg)
S126M	3/8"	6" (152.4 mm)	Blue	9.625" (244.5 mm)	0.15 lb (0.07 kg)



Tapping Tools

Cushion-Grip Multi-Bit Tap Tool Driver

- Increases job speed by combining taps and drivers in one tool
- Each tap size rethreads to next larger size if threads are stripped



32517

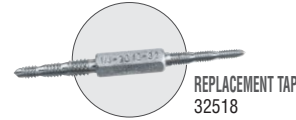

REPLACEMENT TAP
32518



Cat. No.	Nut Driver Sizes	Phillips Bits	Slotted Bits	Other Bits	Shank Length	Handle Color	Overall Length	Weight
32517	1/4", 5/16", 3/8"	#1, #2	1/4" (6.4 mm), 3/16" (4.8 mm)	Taps: 6-32, 8-32, 10-32, 10-24, 12-24, 1/4-20	4" (101.6 mm)	Yellow/Black	7.75" (196.9 mm)	0.50 lb (0.23 kg)

Cushion-Grip 6-in-1 Tap Tool

- Quickly forms new threads, re-forms burred threads, and cleans out plaster obstructions
- Each tap size rethreads to next larger size if threads are stripped



626



REPLACEMENT TAPS
628-20 (10-24, 12-24, 1/4-20)
626-32 (6-32, 8-32, 10-32)

Cat. No.	Tap Sizes	Overall Length	Weight
626	6-in-1 Tap 6-32, 8-32, 10-32, 10-24, 12-24, 1/4-20	7.75" (196.9 mm)	0.25 lb (0.11 kg)

6-in-1 Tapping Tool

- Quickly forms new threads, re-forms burred threads, and cleans out plaster obstructions
- Each tap size rethreads to next larger size if threads are stripped
- Two high-carbon steel taps are secured in reversible holder



627-20



REPLACEMENT TAPS
628-20 (10-24, 12-24, 1/4-20)
626-32 (6-32, 8-32, 10-32)

Cat. No.	Tap Sizes	Overall Length	Weight
627-20	6-32, 8-32, 10-32, 10-24, 12-24, 1/4-20	7.625" (193.7 mm)	0.35 lb (0.16 kg)

Triple Taps

- Quickly forms new threads, re-forms burred threads, and cleans out plaster obstructions
- Each tap size rethreads to next larger size if threads are stripped



625-24



REPLACEMENT TAPS
626-24 (6-32, 8-32, 10-24)
626-32 (6-32, 8-32, 10-32)

Cat. No.	Tap Sizes	Overall Length	Weight
625-24	6-32, 8-32, 10-24	7.125" (181 mm)	0.20 lb (0.09 kg)
625-32	6-32, 8-32, 10-32	7.125" (181 mm)	0.20 lb (0.09 kg)



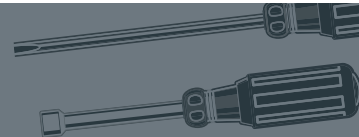

Scratch Awls

Cushion-Grip Scratch Awl

- Professional, heavy-duty, hard-pointed awl
- Scribes metal, starts screw holes, performs a variety of piercing and punching jobs
- Rigid, chrome-plated, heat-treated, tempered-steel shank has full reinforcing bolster at handle for extra strength and impact reinforcement
- Cat. No. 650DD has plated metal strike cap to protect handle from hammer blows and is engineered, manufactured and tested for prying, chiseling and punching



Cat. No. 650 only



650DD

Cat. No.	Shank Length	Overall Length	Weight
650	3.5" (88.9 mm)	7.875" (200 mm)	0.25 lb (0.11 kg)
650DD	3.5" (88.9 mm)	7.875" (200 mm)	0.30 lb (0.14 kg)

Steel Scratch Awl

- One-piece forged-steel blade and bolstered shank
- Heat-treated for long life
- Well-balanced for top efficiency during use
- Black finish for rust resistance



66385

Cat. No.	Overall Length	Shank Length	Weight
66385	7" (177.8 mm)	3.5" (88.9 mm)	0.30 lb (0.14 kg)

Conduit Reamers

Conduit-Fitting and Reaming Screwdriver

- Hooded-blade design keeps tip from slipping out of screws, especially when tightening hard-to-reach conduit fittings. Thicker hood is designed for rugged use
- Reams both the inside and outside of the conduit at the same time
- 5/16" (8 mm) screwdriver tip with 2-1/2" (64 mm) long shank
- Longer Cushion-Grip handle provides comfort and more torque for reaming
- Replaceable reaming blade is now held in place with a 1/6" (1.5 mm) set screw



85191

Cat. No.	Conduit Size	Overall Length	Weight
85191	1/2" (12.7 mm), 3/4" (19.1 mm), 1" (25.4 mm)	7.5" (190.5 mm)	0.50 lb (0.23 kg)

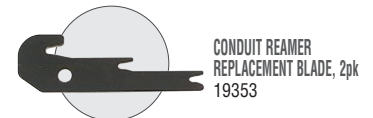

CONDUIT REAMER
REPLACEMENT BLADE, 2pk
19353

Conduit Reamer

- Locks onto screwdrivers; reams and smooths thin-wall conduit
- Reams ID and OD at the same time
- Two set-screws for round- and square-shank screwdrivers
- Fits up to 3/8" (10 mm) keystone-tip screwdrivers
- NOT for use on power tools

Cat. No.	Conduit Size	Overall Length	Weight
19352	1/2" (12.7 mm), 3/4" (19.1 mm), 1" (25.4 mm)	6.75" (171.5 mm)	0.20 lb (0.09 kg)

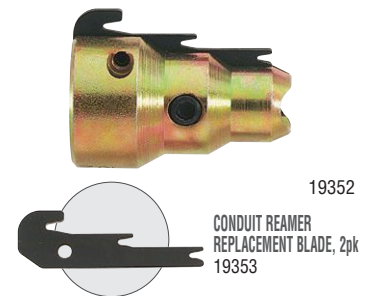

19352

CONDUIT REAMER
REPLACEMENT BLADE, 2pk
19353

Power Conduit Reamer

IMPACT RATED!

- Ream conduit and install fittings in a fraction of the time
- Designed to fit into power drill chucks and quick release adapters; impact ready
- Replacement blades are available and the only approved blade for use in this tool
- Replacement bits are available but any standard 1/4" hex bit will work

Precision engineered
replaceable reaming blade

1/4" hex
quick connect



85091

4x Stronger
Bit Retention

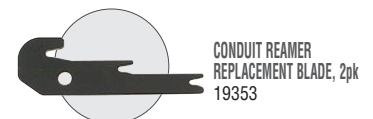

CONDUIT REAMER
REPLACEMENT BLADE, 2pk
19353



NOTE: Read and follow safety instructions in power tool owner's manual.

Cat. No.	Conduit Size	Overall Length	Weight
85091	1/2" (12.7 mm), 3/4" (19.1 mm), 1" (25.4 mm)	5.75" (146.1 mm)	0.33 lb (0.15 kg)

See page 297 for additional information on warnings.



Power Driver Bits

Power Drivers

- Manufactured in the U.S.A. to ensure proper fit in every application, each power driver is precision machined, heat treated and finished to the gold standards Klein Tools puts into every screwdriver blade. Proprietary processes create the longest life power driver bit in the industry.
- Precision machined for better fit, more torque and less wear
- Custom heat treated for long life

Klein Lasts Longer Before Cam Out

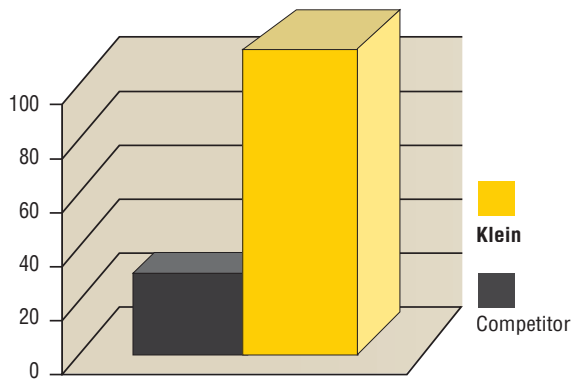

Cat. No.	Overall Length	Bit Type	Package Quantity	Weight
PH115	1" (25.4 mm)	#1 Phillips	5	0.10 oz (2.8 g)
PH1355	3.5" (88.9 mm)	#1 Phillips	5	0.50 oz (14.2 g)
PH162	6" (152.4 mm)	#1 Phillips	2	0.9 oz (26 g)
PH2115	1" (25.4 mm)	#2 Phillips	15	0.10 oz (2.8 g)
PH2355	3.5" (88.9 mm)	#2 Phillips	5	0.50 oz (14.2 g)
PH262	6" (152.4 mm)	#2 Phillips	2	0.9 oz (26 g)
PH315	1" (25.4 mm)	#3 Phillips	5	0.10 oz (2.8 g)
PH3355	3.5" (88.9 mm)	#3 Phillips	5	0.50 oz (14.2 g)
PH362	6" (152.4 mm)	#3 Phillips	2	0.9 oz (26 g)
SL31615	1" (25.4 mm)	3/16" (4.8 mm) Slotted	5	0.10 oz (2.8 g)
SL316355	3.5" (88.9 mm)	3/16" (4.8 mm) Slotted	5	0.50 oz (14.2 g)
SL1415	1" (25.4 mm)	1/4" (6.4 mm) Slotted	5	0.10 oz (2.8 g)
SL14355	3.5" (88.9 mm)	1/4" (6.4 mm) Slotted	5	0.50 oz (14.2 g)

Power Driver Sets				
Cat. No.	Overall Length	Bit Type	Package Quantity	Weight
32234	3.5" (88.9 mm)	#1 and #2 Phillips, #1 and #2 Square, 3/16" Slotted	5	0.10 lb (0.05 kg)
32235	6" (152.4 mm)	#1 and #3 Phillips	2	0.10 lb (0.05 kg)

Power Nut Drivers

- Available in several sizes, these hollow shaft magnetic nut drivers are designed for long bolts, studs or threaded rod jobs.
- Rare Earth magnetic head* holds nuts and bolts to aid in hard to reach installations.
- The 5" and 10" models feature a wrench assist end, designed for high torque loosening found in many jobs.
- Power Nut Driver Set contains 1/4", 5/16" and 3/8" nut drivers (Cat. No. 32759) hard-to-reach



Hollow magnetic shafts for nut running



PND7165



32759



PND71610

Cat. No.	Nut Driver Sizes	Shaft Length	Hollow Depth	Overall Length	Weight
32759	1/4", 5/16", 3/8"	2" (50.8 mm)	1.875" (47.6 mm)	6.313" (160.4 mm)	0.10 lb (0.05 kg)
PND7165	7/16"	5" (127.0 mm)	3.688" (93.7 mm)	6.313" (160.4 mm)	0.16 lb (0.07 kg)
PND125	1/2"	5" (127.0 mm)	3.719" (94.5 mm)	6.297" (159.9 mm)	0.19 lb (0.09 kg)
PND9165	9/16"	5" (127.0 mm)	3.625" (92.1 mm)	6.328" (160.7 mm)	0.23 lb (0.10 kg)
PND71610	7/16"	10" (254.0 mm)	8.813" (223.9 mm)	11.313" (287.4 mm)	0.25 lb (0.11 kg)
PND91610	9/16"	10" (254.0 mm)	8.625" (219.1 mm)	11.313" (287.4 mm)	0.35 lb (0.16 kg)

*Rare earth magnet is globally sourced

NOTE: Read and follow safety instructions in power tool owner's manual.



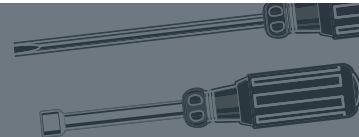

Power Driver Bits

Magnetic Hex Drivers

- For driving sheet metal screws
- Strong rare earth magnets for maximum holding
- 1/4" (6.4 mm) hex shank with quick release groove



86602

Cat. No.	Description	Overall Length	Weight
86600	Magnetic Hex Drivers, 1/4", 3-Pack	1.75" (44.5 mm)	0.12 lb (0.05 kg)
86601	5/16" Magnetic Hex Drivers, 3-Pack	1.75" (44.5 mm)	0.14 lb (0.06 kg)
86602	3/8" Magnetic Hex Drivers, 3-Pack	1.75" (44.5 mm)	0.16 lb (0.07 kg)
8660010	1/4" Magnetic Hex Drivers, 10-pack	1.75" (44.5 mm)	0.43 lb (0.20 kg)
8660110	Magnetic Hex Drivers, 5/16", 10-Pack	1.75" (44.5 mm)	0.49 lb (0.22 kg)

Drill/Tap/Deburr Set

IMPACT RATED!

- For aluminum, brass, copper, plastic, and up to 10 gauge metal
- 1/4" hex for easier application with quick connect
- Set of six tap sizes plus two extra of the smallest taps
- For use on up to 10 gauge metal
- Made of high speed steel for added durability

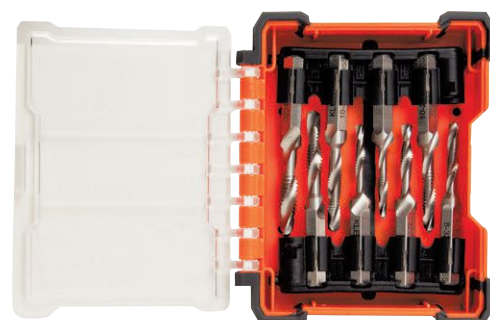

32217

Cat. No.	Tap Sizes	Overall Length	Weight
32217	6-32 (2), 8-32 (2), 10-24, 10-32, 12-24, 1/4-20	4" (101.6 mm)	1.5 lb (0.7 kg)

Cat. No.	Tap Sizes	Weight
32237	6-32	0.25 lb (0.11 kg)
32238	8-32	0.25 lb (0.11 kg)
32239	10-32	0.25 lb (0.11 kg)
32240	10-24	0.25 lb (0.11 kg)
32241	12-24	0.25 lb (0.11 kg)
32242	1/4-20	0.25 lb (0.11 kg)

NOTE: Read and follow safety instructions in power tool owner's manual.

See page 297 for additional information on warnings.



Wrenches

Klein's line of wrenches are forged from the finest steel and are designed to deliver great strength and a long working life. Regardless of the job type, Klein has a wrench that will help the professional complete the task at hand.



For Professionals...
Since 1857™

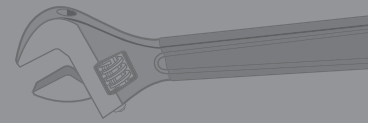

Adjustable Wrenches

Precision-machined jaws are individually chosen and assembled by hand for smooth operation

Chrome-plated for corrosion resistance

Standard and metric scales for faster adjustment

Knurl turns smoothly for easy operation

Contoured handles for comfortable use

Rail is ground for precision fit

Minimally protruding jaw shank for greater capacity in tight spaces

4-threaded knurl worm gear for improved balance



Adjustable Wrenches

Includes core adjustable wrench features plus:

- High capacity smaller wrenches handle bigger jobs, especially in confined spaces
- Extra wide 1/2" jaw that provides the same capacity as a standard 12" adjustable wrench (Cat. No. D509-8)



Chrome



Transparent Red



Blue



D509-8

Cat. No.	Jaw Capacity	Overall Length	Handle Color	Handle Finish	Weight
High Capacity					
507-6	15/16" (23.8 mm)	6.375" (161.9 mm)	Chrome	High-Polish Chrome	0.29 lb (0.13 kg)
507-8	1-1/8" (28.6 mm)	8.125" (206.4 mm)	Chrome	High-Polish Chrome	0.61 lb (0.28 kg)
507-10	1-5/16" (33.3 mm)	10.125" (257.2 mm)	Chrome	High-Polish Chrome	0.98 lb (0.44 kg)
507-12	1-1/2" (38.1 mm)	12.25" (311.2 mm)	Chrome	High-Polish Chrome	1.7 lb (0.8 kg)
D507-6	15/16" (23.8 mm)	6.5" (165.1 mm)	Transparent Red	Plastic-Dipped	0.33 lb (0.15 kg)
D507-8	1-1/8" (28.6 mm)	8.25" (209.6 mm)	Transparent Red	Plastic-Dipped	0.66 lb (0.30 kg)
D507-10	1-5/16" (33.3 mm)	10.25" (260.4 mm)	Transparent Red	Plastic-Dipped	1.1 lb (0.5 kg)
D507-12	1-1/2" (38.1 mm)	12.375" (314.3 mm)	Transparent Red	Plastic-Dipped	1.8 lb (0.8 kg)
Standard Capacity — Extra-Wide Jaw					
D509-8	1-1/2" (38.1 mm)	8.5" (215.9 mm)	Blue	Plastic-Dipped	0.77 lb (0.35 kg)
Standard Capacity					
500-18	2-1/16" (52.4 mm)	18.25" (463.6 mm)	Chrome	High-Polish Chrome	4.7 lb (2.1 kg)
500-24	2-1/2" (63.5 mm)	24" (609.6 mm)	Chrome	High-Polish Chrome	7.8 lb (3.5 kg)
506-15	1-11/16" (42.9 mm)	15.875" (403.2 mm)	Chrome	High-Polish Chrome	2.9 lb (1.3 kg)
D506-4	1/2" (12.7 mm)	4.5" (114.3 mm)	Transparent Red	Plastic-Dipped	0.13 lb (0.06 kg)

Adjustable Wrenches - Slim Jaw

Includes core adjustable wrench features plus:

- Designed for tight-wrench-over-wrench applications
- Jaws meet ASME 107.11-2010 testing standards for adjustable wrenches while being 40% slimmer than most standard adjustable wrench jaws
- 1-1/2" extra wide jaw capacity that is 5/16" larger than other wide-capacity 8" wrenches (Cat. No. D86936)
- Standard and metric size markings for fast adjustment
- Manufactured for strength and durability



40% Slimmer Jaw



D86936

Cat. No.	Jaw Capacity	Overall Length	Handle Color	Handle Finish	Weight
D86932	1/2" (12.7 mm)	4.563" (115.9 mm)	Blue	Plastic Dipped	2.4 oz (0.07 kg)
D86934	1" (25.4 mm)	6.406" (162.7 mm)	Blue	Plastic Dipped	0.31 lb (0.14 kg)
D86936	1-1/2" (38.1 mm)	8.375" (212.7 mm)	Blue	Plastic Dipped	0.67 lb (0.30 kg)



2-in-1 Reversible Adjustable Pipe Wrench

Includes core adjustable wrench features plus:

- Versatile 2-in-1 tool converts from adjustable wrench to pipe wrench by reversing the removable jaw
- Reversible jaw has teeth and an obtuse angle to work as a pipe wrench
- Pipe wrench side of jaw grips pipes and round fasteners with self-gripping angled teeth
- 1-1/2" extra-wide jaw opening in both configurations
- Standard and metric size markings for fast adjustment
- Meets ASME 107.11-2010 standards for adjustable wrenches



D86930



Cat. No.	Jaw Capacity	Overall Length	Handle Color	Handle Finish	Weight
D86930	1-1/2" (38 mm)	10.25" (260.4 mm)	Blue	Plastic Dipped	1.0 lb (0.5 kg)

Corrosion resistant

Forged from the highest quality alloy steel

Durable chrome-plated finish

Open ends are offset at standard 15° angle
for confined working areas

Box ends have 15° angle offset
to provide clearance over obstructions

Combination Wrenches

Combination wrenches have the same size opening on each end

Combination Wrenches - SAE

Cat. No.	Size	Box End Point	Overall Length	Weight
68410	1/4"	12	5.125" (130.2 mm)	0.80 oz (22.7 g)
68411	5/16"	12	4.375" (111.1 mm)	0.80 oz (22.7 g)
68412	3/8"	12	6.125" (155.6 mm)	0.10 lb (0.05 kg)
68413	7/16"	12	6.625" (168.3 mm)	0.14 lb (0.06 kg)
68414	1/2"	12	7.125" (181 mm)	0.18 lb (0.08 kg)
68415	9/16"	12	7.5" (190.5 mm)	0.23 lb (0.10 kg)
68416	5/8"	12	8.5" (215.9 mm)	0.28 lb (0.13 kg)
68417	11/16"	12	9" (228.6 mm)	0.37 lb (0.17 kg)
68418	3/4"	12	9.875" (250.8 mm)	0.46 lb (0.21 kg)
68419	13/16"	12	10.625" (269.9 mm)	0.53 lb (0.24 kg)
68420	7/8"	12	11.5" (292.1 mm)	0.67 lb (0.30 kg)
68421	15/16"	12	12.5" (317.5 mm)	0.79 lb (0.36 kg)
68422	1"	12	13.25" (336.6 mm)	0.93 lb (0.42 kg)
68423	1-1/16"	12	14.25" (362 mm)	1.2 lb (0.5 kg)
68424	1-1/8"	12	15.5" (393.7 mm)	1.5 lb (0.7 kg)
68425	1-1/4"	12	16.25" (412.8 mm)	1.9 lb (0.9 kg)



68417



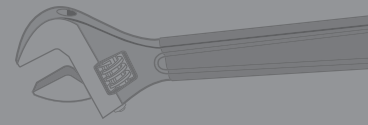

Combination Wrench Sets - SAE

Combination Wrench Sets - SAE

- Includes pouch with marked pockets for each wrench

Cat. No.	Set Contains	Weight	
68400	Combination Wrench Set, 7-Piece	1.2 lb (0.6 kg)	
Cat. No.	Size	Box End Point	Overall Length
68410	1/4"	12	5.125" (130.2 mm)
68411	5/16"	12	4.375" (111.1 mm)
68412	3/8"	12	6.125" (155.6 mm)
68413	7/16"	12	6.625" (168.3 mm)
68414	1/2"	12	7.125" (181 mm)
68415	9/16"	12	7.5" (190.5 mm)
68416	5/8"	12	8.5" (215.9 mm)



68400

Cat. No.	Set Contains	Weight	
68402	Combination Wrench Set, 9-Piece	2.1 lb (0.9 kg)	
Cat. No.	Size	Box End Point	Overall Length
68410	1/4"	12	5.125" (130.2 mm)
68411	5/16"	12	4.375" (111.1 mm)
68412	3/8"	12	6.125" (155.6 mm)
68413	7/16"	12	6.625" (168.3 mm)
68414	1/2"	12	7.125" (181 mm)
68415	9/16"	12	7.5" (190.5 mm)
68416	5/8"	12	8.5" (215.9 mm)
68417	11/16"	12	9" (228.6 mm)
68418	3/4"	12	9.875" (250.8 mm)



68402

Cat. No.	Set Contains	Weight	
68404	Combination Wrench Set, 12-Piece	4.1 lb (1.9 kg)	
Cat. No.	Size	Box End Point	Overall Length
68410	1/4"	12	5.125" (130.2 mm)
68411	5/16"	12	4.375" (111.1 mm)
68412	3/8"	12	6.125" (155.6 mm)
68413	7/16"	12	6.625" (168.3 mm)
68414	1/2"	12	7.125" (181 mm)
68415	9/16"	12	7.5" (190.5 mm)
68416	5/8"	12	8.5" (215.9 mm)
68417	11/16"	12	9" (228.6 mm)
68418	3/4"	12	9.875" (250.8 mm)
68419	13/16"	12	10.625" (269.9 mm)
68420	7/8"	12	11.5" (292.1 mm)
68421	15/16"	12	12.5" (317.5 mm)



68404

Cat. No.	Set Contains	Weight	
68406	Combination Wrench Set, 14-Piece	9.8 lb (4.4 kg)	
Cat. No.	Size	Box End Point	Overall Length
68412	3/8"	12	6.125" (155.6 mm)
68413	7/16"	12	6.625" (168.3 mm)
68414	1/2"	12	7.125" (181 mm)
68415	9/16"	12	7.5" (190.5 mm)
68416	5/8"	12	8.5" (215.9 mm)
68417	11/16"	12	9" (228.6 mm)
68418	3/4"	12	9.875" (250.8 mm)
68419	13/16"	12	10.625" (269.9 mm)
68420	7/8"	12	11.5" (292.1 mm)
68421	15/16"	12	12.5" (317.5 mm)
68422	1"	12	13.25" (336.6 mm)
68423	1-1/16"	12	14.25" (362 mm)
68424	1-1/8"	12	15.5" (393.7 mm)
68425	1-1/4"	12	16.25" (412.8 mm)



68406

Individual wrenches sold separately.

See page 297 for additional information on warnings.



Combination Wrenches - Metric

Combination Wrenches - Metric

Cat. No.	Size	Box End Point	Overall Length	Weight
68507	7 mm	12	5.125" (130.2 mm)	0.80 oz (22.7 g)
68508	8 mm	12	5.375" (136.5 mm)	1.3 oz (37 g)
68509	9 mm	12	6.125" (155.6 mm)	0.10 lb (0.05 kg)
68510	10 mm	12	6.5" (165.1 mm)	0.13 lb (0.06 kg)
68511	11 mm	12	6.5" (165.1 mm)	0.13 lb (0.06 kg)
68512	12 mm	12	7.125" (181 mm)	0.18 lb (0.08 kg)
68513	13 mm	12	7.125" (181 mm)	0.16 lb (0.07 kg)
68514	14 mm	12	7.5" (190.5 mm)	0.22 lb (0.10 kg)
68515	15 mm	12	7.5" (190.5 mm)	0.22 lb (0.10 kg)
68517	17 mm	12	9" (228.6 mm)	0.39 lb (0.18 kg)
68519	19 mm	12	9.75" (247.7 mm)	0.42 lb (0.19 kg)



68512

Combination Wrench Sets - Metric

- Includes pouch with marked pockets for each wrench

Cat. No.	Set Contains	Weight
68500	Combination Wrench Set, Metric, 7-Piece	1.2 lb (0.6 kg)

Cat. No.	Size	Box End Point	Overall Length
68507	7 mm	12	5.125" (130.2 mm)
68509	9 mm	12	6.125" (155.6 mm)
68510	10 mm	12	6.5" (165.1 mm)
68511	11 mm	12	6.5" (165.1 mm)
68513	13 mm	12	7.125" (181 mm)
68514	14 mm	12	7.5" (190.5 mm)
68515	15 mm	12	7.5" (190.5 mm)



68402

Cat. No.	Set Contains	Weight
68502	Metric Combination Wrench Set, 11-Piece	2.4 lb (1.1 kg)

Cat. No.	Size	Box End Point	Overall Length
68507	7 mm	12	5.125" (130.2 mm)
68508	8 mm	12	5.375" (136.5 mm)
68509	9 mm	12	6.125" (155.6 mm)
68510	10 mm	12	6.5" (165.1 mm)
68511	11 mm	12	6.5" (165.1 mm)
68512	12 mm	12	7.125" (181 mm)
68513	13 mm	12	7.125" (181 mm)
68514	14 mm	12	7.5" (190.5 mm)
68515	15 mm	12	7.5" (190.5 mm)
68517	17 mm	12	9" (228.6 mm)
68519	19 mm	12	9.75" (247.7 mm)



68502

Individual wrenches sold separately.



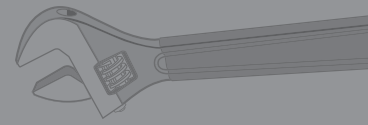

Open-End Wrenches

Corrosion resistant

Forged from the highest quality alloy steel

Different size opening on each end of wrench

Ends are offset at 15° angle for clearance over obstructions

Durable chrome-plated finish



Open-End Wrenches - SAE

Cat. No.	Large Size	Small Size	Overall Length	Weight
68460	5/16"	1/4"	4.75" (120.7 mm)	0.64 oz (18.1 g)
68461	7/16"	3/8"	6" (152.4 mm)	0.10 lb (0.05 kg)
68462	9/16"	1/2"	7" (177.8 mm)	0.17 lb (0.08 kg)
68463	5/8"	9/16"	7.5" (190.5 mm)	0.20 lb (0.09 kg)
68464	3/4"	11/16"	9" (228.6 mm)	0.36 lb (0.16 kg)
68465	7/8"	13/16"	10" (254.0 mm)	0.55 lb (0.25 kg)
68466	1"	15/16"	11" (279.4 mm)	0.80 lb (0.36 kg)



68463

Open-End Wrench Sets

- Includes pouch with marked pockets for each wrench

Cat. No.	Set Contains	Weight	
68450	Open-End Wrench Set, 5-Piece	1.1 lb (0.5 kg)	
Cat. No.	Large Size	Small Size	Overall Length
68460	5/16"	1/4"	4.75" (120.7 mm)
68461	7/16"	3/8"	6" (152.4 mm)
68462	9/16"	1/2"	7" (177.8 mm)
68463	5/8"	9/16"	7.5" (190.5 mm)
68464	3/4"	11/16"	9" (228.6 mm)

Cat. No.	Set Contains	Weight	
68452	Open-End Wrench Set, 7-Piece	2.5 lb (1.1 kg)	
Cat. No.	Large Size	Small Size	Overall Length
68460	5/16"	1/4"	4.75" (120.7 mm)
68461	7/16"	3/8"	6" (152.4 mm)
68462	9/16"	1/2"	7" (177.8 mm)
68463	5/8"	9/16"	7.5" (190.5 mm)
68464	3/4"	11/16"	9" (228.6 mm)
68465	7/8"	13/16"	10" (254.0 mm)
68466	1"	15/16"	11" (279.4 mm)

Individual wrenches sold separately.



68450



68452

See page 297 for additional information on warnings.



Socket Wrenches

Sockets



65717 – Deep



65704 – Standard

Cat. No.	Drive Size	Socket Size	Number of Points	Weight
Imperial Socket Depth				
65600	1/4"	3/16"	6	0.32 oz (9.1 g)
65601	1/4"	7/32"	6	0.32 oz (9.1 g)
65602	1/4"	1/4"	6	0.32 oz (9.1 g)
65603	1/4"	9/32"	6	0.32 oz (9.1 g)
65604	1/4"	5/16"	6	0.32 oz (9.1 g)
65605	1/4"	11/32"	6	0.48 oz (13.6 g)
65606	1/4"	3/8"	6	0.64 oz (18.1 g)
65607	1/4"	7/16"	6	0.64 oz (18.1 g)
65608	1/4"	1/2"	6	0.80 oz (22.7 g)
65700	3/8"	3/8"	6	0.80 oz (22.7 g)
65701	3/8"	7/16"	6	0.80 oz (22.7 g)
65702	3/8"	1/2"	6	1.0 oz (28 g)
65703	3/8"	9/16"	6	1.0 oz (28 g)
Imperial Deep Socket Depth				
65610	1/4"	1/4"	6	1.0 oz (28 g)
65611	1/4"	9/32"	6	1.0 oz (28 g)
65613	1/4"	11/32"	6	1.1 oz (31 g)
65614	1/4"	3/8"	6	1.3 oz (37 g)
65615	1/4"	7/16"	6	1.4 oz (40 g)
65711	3/8"	7/16"	6	1.6 oz (45 g)
65712	3/8"	1/2"	6	2.1 oz (59 g)
65713	3/8"	9/16"	6	2.4 oz (68 g)
65714	3/8"	5/8"	6	3.5 oz (100 g)
65715	3/8"	11/16"	6	4.3 oz (122 g)
65716	3/8"	3/4"	6	4.5 oz (127 g)
65717	3/8"	13/16"	6	5.4 oz (154 g)
Metric				
65907	3/8"	7 mm	6	0.64 oz (18.1 g)
65908	3/8"	8 mm	6	0.64 oz (18.1 g)
65909	3/8"	9 mm	6	0.80 oz (22.7 g)
65910	3/8"	10 mm	6	0.80 oz (22.7 g)
65911	3/8"	11 mm	6	0.80 oz (22.7 g)
65912	3/8"	12 mm	6	1.0 oz (28 g)
65913	3/8"	13 mm	6	1.1 oz (31 g)
65914	3/8"	14 mm	6	1.3 oz (37 g)
65915	3/8"	15 mm	6	1.6 oz (45 g)
65916	3/8"	16 mm	6	1.4 oz (40 g)
65917	3/8"	17 mm	6	1.6 oz (45 g)
65918	3/8"	18 mm	6	1.8 oz (50 g)
65919	3/8"	19 mm	6	2.2 oz (64 g)
Imperial Socket Depth				
65704	3/8"	5/8"	12	1.3 oz (37 g)
65705	3/8"	11/16"	12	1.8 oz (50 g)
65706	3/8"	3/4"	12	1.9 oz (54 g)
65707	3/8"	13/16"	12	2.4 oz (68 g)
65708	3/8"	7/8"	12	3.0 oz (86 g)
65800	1/2"	7/16"	12	1.9 oz (54 g)
65801	1/2"	1/2"	12	1.9 oz (54 g)
65802	1/2"	9/16"	12	1.9 oz (54 g)
65804	1/2"	11/16"	12	2.4 oz (68 g)
65805	1/2"	3/4"	12	3.2 oz (91 g)
65806	1/2"	13/16"	12	3.2 oz (91 g)
65807	1/2"	7/8"	12	3.2 oz (91 g)
65808	1/2"	15/16"	12	4.0 oz (113 g)
65809	1/2"	1"	12	4.8 oz (136 g)
65810	1/2"	1-1/16"	12	5.6 oz (159 g)
65811	1/2"	1-1/8"	12	6.4 oz (181 g)
65812	1/2"	1-1/4"	12	8 oz (227 g)
Imperial Deep Socket Depth				
65825	1/2"	1/2"	12	4.8 oz (136 g)
65826	1/2"	9/16"	12	5.0 oz (141 g)
65827	1/2"	5/8"	12	3.8 oz (109 g)
65828	1/2"	11/16"	12	5.1 oz (145 g)
65829	1/2"	3/4"	12	5.8 oz (163 g)
65830	1/2"	13/16"	12	6.6 oz (186 g)
65831	1/2"	7/8"	12	6.6 oz (186 g)

1/4" Drivers and Extensions



Cat. No.	Description	Weight
65620	4-3/4" Ratchet, 1/4" Drive	0.32 lb (0.15 kg)
65621	Spinner Handle	0.19 lb (0.09 kg)
65622	2" Extension with 1/4" Socket Size	0.80 oz (22.7 g)
65623	6" Extension	0.14 lb (0.06 kg)

3/8" Drivers and Extensions

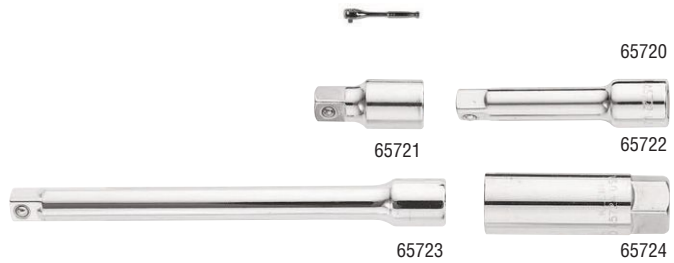

Cat. No.	Description	Weight
65720	7" Ratchet, 3/8" Drive	0.73 lb (0.33 kg)
65721	1-3/4" Extension	1.4 oz (40 g)
65722	3" Extension	0.15 lb (0.07 kg)
65723	6" Extension 3/8" Socket Size	0.30 lb (0.14 kg)
65724	5/8" Spark Plug Socket, 3/8" Drive	3.4 oz (95 g)

1/2" Drivers and Extensions



Cat. No.	Description	Weight
65820	10" Ratchet, 1/2" Drive	1.3 lb (0.6 kg)
65821	5" Extension, 1/2" Drive	0.45 lb (0.20 kg)
65823	5/8" Spark Plug Socket 1/2" Drive	2.9 oz (82 g)



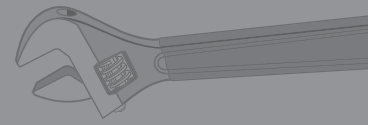

Socket Wrench Sets

13-Piece 1/4" Drive Socket Wrench Set



Set consists of the following pieces:

- Nine 6-point sockets: 3/16", 7/32", 1/4", 9/32", 5/16", 11/32", 3/8", 7/16", and 1/2"
- One spinner handle
- Two extensions: 2" and 6" long
- One ratchet
- Hinged metal box

65500

Cat. No.	Description	Weight
65500	1/4" Drive Socket Wrench Set, 13-Piece	2.1 lb (0.9 kg)

12-Piece 3/8" Drive Socket Wrench Set



Set consists of the following pieces:

- Four 6-point sockets: 3/8", 7/16", 1/2", and 9/16"
- Four 12-point sockets: 5/8", 11/16", 3/4", and 13/16"
- One spark plug socket: 5/8"
- Two extensions: 1-3/4" and 6" long
- One ratchet
- Hinged metal box

65504

Cat. No.	Description	Weight
65504	3/8" Drive Socket Wrench Set, 12-Piece	3.6 lb (1.6 kg)

8-Piece 3/8" Drive Deep-Socket Set



65502

Set consists of the following pieces:

- Eight 6-point deep sockets: 3/8", 7/16", 1/2", 9/16", 5/8", 11/16", 3/4", and 13/16"
- Hinged metal box

Cat. No.	Description	Weight
65502	3/8" Drive Deep Socket Wrench Set, 8-Piece	2.7 lb (1.2 kg)

20-Piece 3/8" Drive Socket Wrench Set



65508

Set consists of the following pieces:

- Four 6-point sockets: 3/8", 7/16", 1/2", and 9/16"
- Five 12-point sockets: 5/8", 11/16", 3/4", 13/16", and 7/8"
- Eight 6-point deep sockets: 3/8", 7/16", 1/2", 9/16", 5/8", 11/16", 3/4", and 13/16"
- Two extensions: 1-3/4" and 3" long
- One ratchet
- Hinged metal box

Cat. No.	Description	Weight
65508	3/8" Drive Socket Wrench Set, 20-Piece	5.4 lb (2.5 kg)

See page 297 for additional information on warnings.



Socket Wrench Sets

13-Piece 3/8" Drive Socket Set - Metric



65506

Set consists of the following pieces:

- Thirteen 6-point sockets: 7, 8, 9, 10, 11, 12, 13, 14, 15, 16, 17, 18, and 19 mm
- Handy, flip-lock tray

Cat. No.	Description	Weight
65506	3/8" Drive Socket Set, Metric, 13-Piece	1.3 lb (0.6 kg)

8-Piece 1/2" Drive Deep-Socket Set



65514

Set consists of the following pieces:

- Eight 12-point deep sockets: 1/2", 9/16", 5/8", 11/16", 3/4", 13/16", 7/8", and 15/16"
- Hinged metal box

Cat. No.	Description	Weight
65514	1/2" Drive Deep Socket Wrench Set, 8-Piece	4.5 lb (2.1 kg)

12-Piece 1/2" Drive Socket Wrench Set



65510

Set consists of the following pieces:

- Nine 12-point sockets: 7/16", 1/2", 9/16", 5/8", 11/16", 3/4", 13/16", 7/8", and 15/16"
- One extension: 5" long
- One spark plug socket: 5/8"
- One ratchet
- Hinged metal box

Cat. No.	Description	Weight
65510	1/2" Drive Socket Wrench Set, 12-Piece	5.4 lb (2.4 kg)

16-Piece 1/2" Drive Socket Wrench Set



65512

Set consists of the following pieces:

- Thirteen 12-point sockets: 7/16", 1/2", 9/16", 5/8", 11/16", 3/4", 13/16", 7/8", 15/16", 1", 1-1/16", 1-1/8", and 1-1/4"
- One extension: 5" long
- One flex handle: 17" long
- One ratchet
- Hinged metal box

Cat. No.	Description	Weight
65512	Socket Wrench Set, 1/2" Drive, 16-Piece	9.6 lb (4.4 kg)



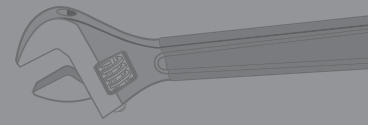

Ratcheting Box Wrenches

For use in confined spaces and on long studs

Different size opening on each end



Reverse ratcheting action by simply turning wrench over

Ratcheting Box Wrenches

Cat. No.	Size	Number of Points	Overall Length	Weight
68200	1/4" x 5/16"	12	4.375" (111.1 mm)	0.13 lb (0.06 kg)
68201	3/8" x 7/16"	12	5.5" (139.7 mm)	0.18 lb (0.08 kg)
68202	1/2" x 9/16"	12	6.875" (174.6 mm)	0.29 lb (0.13 kg)
68203	5/8" x 11/16"	12	8.25" (209.6 mm)	0.43 lb (0.20 kg)
68204	5/8" x 3/4"	12	8.25" (209.6 mm)	0.42 lb (0.19 kg)
68205	11/16" x 3/4"	12	9.25" (235 mm)	0.52 lb (0.24 kg)
68206	13/16" x 7/8"	12	9.25" (235 mm)	0.69 lb (0.31 kg)



68201

Ratcheting Box Wrench Sets

Includes core ratcheting box wrench features plus:

- Includes vinyl roll-up pouch

Cat. No.	Set Contains	Weight	
68221	Ratcheting Box Wrench Set, 5-Piece	2.7 lb (1.2 kg)	
Cat. No.	Size	Number of Points	Overall Length
68200	1/4" x 5/16"	12	4.375" (111.1 mm)
68201	3/8" x 7/16"	12	5.5" (139.7 mm)
68202	1/2" x 9/16"	12	6.875" (174.6 mm)
68203	5/8" x 11/16"	12	8.25" (209.6 mm)
68204	5/8" x 3/4"	12	8.25" (209.6 mm)
Cat. No.	Set Contains	Weight	
68222	7 Piece Ratcheting Box Wrench Set	1.5 lb (0.7 kg)	
Cat. No.	Size	Number of Points	Overall Length
68200	1/4" x 5/16"	12	4.375" (111.1 mm)
68201	3/8" x 7/16"	12	5.5" (139.7 mm)
68202	1/2" x 9/16"	12	6.875" (174.6 mm)
68203	5/8" x 11/16"	12	8.25" (209.6 mm)
68204	5/8" x 3/4"	12	8.25" (209.6 mm)
68205	11/16" x 3/4"	12	9.25" (235 mm)
68206	13/16" x 7/8"	12	9.25" (235 mm)

Individual wrenches sold separately.



68222

See page 297 for additional information on warnings.



Ratcheting Refrigeration Wrenches

Includes core ratcheting box wrench features plus:

- Fully reversible for refrigeration-packing gland nuts, valve stem sockets and beam-clamp installation
- Compact in size, with clearly marked sockets for four nut sizes
- Quick-flip reversing lever permits instant ratchet reversal
- Polished chrome finish for smooth edges for comfort



68310



86939

Cat. No.	Size	Overall Length	Weight
68309	3/16" and 1/4" Sq. x 1/2" and 9/16" Hex	6.813" (173.1 mm)	0.43 lb (0.20 kg)
68310	3/16" and 5/16" Sq. x 1/4" and 3/8" Sq.	5.5" (139.7 mm)	0.20 lb (0.09 kg)

Additional Items					
Cat. No.	Description	Hex Size	Connector Type	Overall Length	Weight
NEW 86939	Hex Key Adapter for Refrigeration Wrench	3/16" and 5/16"	Spring Loaded Ball Bearing	2.125" (54.0 mm)	0.7 oz (20 g)

Ratcheting Offset Box Wrenches

Fully Reversible Ratcheting Offset Box Wrenches

Includes core ratcheting box wrench features plus:

- Both ends are offset 25° for more convenient use in confined spaces
- Quick-flip reversing lever for instant ratchet reversal



68236

Cat. No.	Size	Number of Points	Overall Length	Weight
68234	1/4" x 5/16"	6	4.375" (111.1 mm)	0.13 lb (0.06 kg)
68236	3/8" x 7/16"	6	5.5" (139.7 mm)	0.18 lb (0.08 kg)
68238	1/2" x 9/16"	6	6.75" (171.5 mm)	0.30 lb (0.14 kg)
68240	5/8" x 11/16"	12	8.125" (206.4 mm)	0.46 lb (0.21 kg)
68242	3/4" x 7/8"	12	9.125" (231.8 mm)	0.50 lb (0.23 kg)

Fully Reversible Ratcheting Offset Box Wrench Sets

Includes core ratcheting box wrench features plus:

- Includes vinyl roll-up pouch

Cat. No.	Set Contains	Weight	
68244	Reversible Ratcheting Box Wrench Set, 3-Piece	0.61 lb (0.3 kg)	
Cat. No.	Size	Number of Points	Overall Length
68234	1/4" x 5/16"	6	4.375" (111.1 mm)
68236	3/8" x 7/16"	6	5.5" (139.7 mm)
68238	1/2" x 9/16"	6	6.75" (171.5 mm)

Cat. No.	Set Contains	Weight	
68245	Reversible Ratcheting Box Wrench Set, 5-Piece	0.61 lb (0.28 kg)	
Cat. No.	Size	Number of Points	Overall Length
68234	1/4" x 5/16"	6	4.375" (111.1 mm)
68236	3/8" x 7/16"	6	5.5" (139.7 mm)
68238	1/2" x 9/16"	6	6.75" (171.5 mm)
68240	5/8" x 11/16"	12	8.125" (206.4 mm)
68242	3/4" x 7/8"	12	9.125" (231.8 mm)

Individual wrenches sold separately.



68245



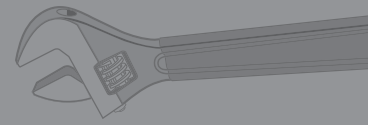

Specialty Wrenches

Conduit Locknut Wrench

- Easily attach locknuts in tight or deep cut-in boxes
- For 1/2" and 3/4" connectors
- Direct-drive heads rotate each other when twisted
- Heavy-duty steel construction enables needed torque to loosen or tighten connectors
- Perfect for remodel work where box is filled with existing wires



56999



US Patent pending

Cat. No.	Size	Overall Length	Weight
56999	1/2" and 3/4"	9" (228.6 mm)	0.70 lb (0.32 kg)

Can Wrench

- Two tools in one; saves space in your pouch
- One end opens telephone box fasteners, the other end tightens nuts on binding-post terminals
- The 7/16" socket has a black finish and the 3/8" socket has a silver finish
- Sockets are 1-1/4" (32 mm) deep to fit over long binding posts and are thin-walled for easy access into tight areas
- Hex-socket design enables using a wrench to obtain extra torque
- High-impact, break-resistant handle for long and dependable service
- Sockets are heat-treated, alloy steel



68005



Cat. No.	Socket Size	Handle Diameter	Overall Length	Weight
68005	3/8" and 7/16" Hex Nut	1" (25.4 mm)	7" (177.8 mm)	0.35 lb (0.16 kg)

Lineman's Ratcheting Box Wrenches

- 1/2", 9/16", 5/8" and 3/4" sizes in one tool (Cat. No. KT223X4)
- Solid, one piece design (Cat. No. KT223X4) NOT INSULATED



KT223X4

Cat. No.	Description	Size	Number of Points	Overall Length	Weight
KT223X4	Lineman's Ratcheting 4-in-1 Box Wrench	1/2", 9/16", 5/8", 3/4"	12	8.25" (209.6 mm)	10.0 lb (4.5 kg)
KT223X4-INS	Lineman's Insulating 4-in-1 Box Wrench	1/2", 9/16", 5/8", 3/4"	12	9" (228.6 mm)	0.70 lb (0.32 kg)



KT223X4-INS

Lineman's Wrenches

- Forged from special bar steel and heat-treated for long life
- Each end has two different size openings
- Hole is provided at larger end for turning-in standard pole steps
- Wrench is suited for use on heavy three-bolt guy clamps on which clearance is limited
- Cat. Nos. 3146 and 3146A are dark blue; Cat. No. 3146B is Silver
- Small end is painted silver on Cat. No. 3146A
- Cat. No. 3146B features end openings sized to NEMA hardware specifications



3146



Dark Blue - 3146



Blue/Silver - 3146



Silver - 3146B

Cat. No.	Application	Overall Length	Large Size	Small Size	Weight
3146	5/8" (15.9 mm) Hardware	13" (330.2 mm)	29/32" and 1-3/32"	5/8" and 13/16"	1.9 lb (0.8 kg)
3146A	3/4" (19.1 mm) Hardware	13" (330.2 mm)	1-1/16" and 1-5/16"	5/8" and 7/8"	1.7 lb (0.8 kg)
3146B	Bell System Type	13" (330.2 mm)	1-1/16" and 1-3/16"	11/16" and 7/8"	1.8 lb (0.8 kg)

See page 297 for additional information on warnings.



Specialty Wrenches

Lineman's Ratcheting Wrenches

- Bolt-through design allows bolts to pass through the socket
- 3/4" and 1" x 1-1/8" combination square socket sizes for most common utility hardware
- Bright yellow socket for easy visibility
- Works on most common utility pole hardware, such as lag bolts, "C" clamps and suspension bolts
- Side ridges that provide a better grip and includes 13/16" square socket size (Cat. No. KT152T)

Cat. No.	Description	Overall Length	Size	Number of Points	Weight
KT151T	Lineman's Ratcheting Wrench	13" (330.2 mm)	3/4", 1", 1-1/8"	8	2.1 lb (1.0 kg)
KT152T	Lineman's Slim Ratcheting Wrench	13.25" (336.6 mm)	3/4", 13/16", 1" and 1-1/8"	8	2.1 lb (1.0 kg)
KT155HD	5-in-1 Lineman's Ratcheting Wrench, Heavy Duty	12" (304.8 mm)	9/16" and 3/4"	8	2.1 lb (1.0 kg)
KT155T	5-in-1 Lineman's Ratcheting Wrench	9.375" (238.1 mm)	9/16" and 3/4"	8	1.4 lb (0.6 kg)



2-in-1 Impact Sockets

- Single ended impact socket wrench with hands-free adjustment between socket sizes
- Two coaxial spring-loaded 3/4" and 9/16" hex socket sizes in one tool
- Deep socket with a 1/2" drive works great for pole hardware installation and removal
- High-torque design is easier to position; Cat. No. 66001 works with square fasteners and Cat. No. 66004 works with hex fasteners
- Cross hole design to prevent unintentional separation of adapter and socket
- Engineered for use with impact drivers



Cat. No.	Drive Size	Socket Size	Number of Points	Weight
66001	1/2"	3/4" and 9/16"	12	0.5 lbs. (0.23 kg)
66004	1/2"	3/4" and 9/16"	6	0.5 lb (0.23 kg)

Impact Sockets

- Fine-tuned ball detent provides improved retention, minimizing drops
- Long hollow shaft allows use on long threaded bolts
- Quick-change adapter included on all sockets
- Adapters extend or retract head for easy access to the size you need
- Do not exceed 200 ft./lbs. of torque



Cat. No.	Description	Overall Length	Socket Size	Weight
NRHD	3-in-1 Impact Socket	7.75" (196.9 mm)	3/4", 1", 1-1/8"	2.0 lb (0.9 kg)
NRHD3	Single Ended Impact Socket	10" (254.0 mm)	to 1-1/8" (28.6 mm) Square	2.0 lb (0.9 kg)
NRHD4	4-in-1 Square Impact Socket	9" (228.6 mm)	Square - 3/4", 13/16", 1" and 1-1/8"	2.26 lb (1.03 kg)
NRHDA	Adapter for NRHD	4.906" (124.6 mm)	7/16"	0.36 lb (0.16 kg)
NRHDA3	Adapter for NRHD3	2.469" (62.7 mm)	1/2"	0.18 lb (0.08 kg)
NRHDA4	Adapter for NRHD4	2.75" (69.9 mm)	1/2" Male Square	0.18 lb (0.08 kg)

NOTE: Read and follow safety instructions in power tool owner's manual.



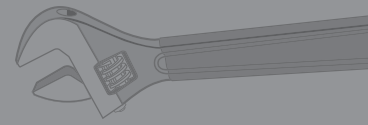

Construction Wrenches

Adjustable-Head Construction Wrenches

- Eliminates the need for carrying several fixed-size wrenches
- Forged from select alloy steel with continuous taper handle for aligning bolt and/or rivet holes
- Industrial black finish for corrosion resistance
- Includes lanyard hole for easy tool tethering
- Precision-machines jaws are individually chosen and assembled by hand for smooth operation
- Heat-treated for long life



3239

Cat. No.	Overall Length	Handle Color	Handle Finish	Jaw Capacity	Weight
3239	16" (406.4 mm)	Black	Black Oxide	1-1/2" (38.1 mm)	2.4 lb (1.1 kg)
3227	11" (279.4 mm)	Black	Black Oxide	1-5/16" (33.3 mm)	1.2 lb (0.5 kg)

1/2" Drive Ratcheting Construction Wrench

- Accepts 1/2" square-drive hex socket
- Reversible ratchet
- Eliminates the need for carrying several fixed-size wrenches
- Forged from select alloy steel with continuous taper handle for aligning bolt and/or rivet holes
- Industrial black finish for corrosion resistance



3238

Cat. No.	Overall Length	Size	Weight
3238	15" (381.0 mm)	1/2"	2.1 lb (1.0 kg)

Erection Wrenches

- Forged from select alloy steel to withstand high-leverage and heavy loads
- Extra-heavy-duty head area gives maximum strength and durability
- Continuous taper of handle makes lining-up bolt holes easy and works on a range of bolt-hole sizes without binding
- Extra-large hub area works on larger diameter holes better than other wrenches
- Catalog number, bolt size and nominal opening size are stamped on every wrench for easy identification
- American Bridge design
- Cat. Nos. 3212TT, 3213TT, and 3214TT feature tether hole for working at height



3231



3214TT

Cat. No.	Overall Length	Nut Type	Bolt Size	Nominal Opening	Head Width	Taper Diameter	Weight
3210	14.75" (374.7 mm)	U.S. Heavy	1/2" (12.7 mm)	7/8" (22.2 mm)	2.25" (57.2 mm)	7/8" to 3/16" (22.2 to 4.8 mm)	1.4 lb (0.6 kg)
3211	14.75" (374.7 mm)	U.S. Heavy	5/8" (15.9 mm)	1-1/16" (27.0 mm)	2.25" (57.2 mm)	7/8" to 3/16" (22.2 to 4.8 mm)	1.3 lb (0.6 kg)
3212	16.625" (422.3 mm)	U.S. Heavy	3/4" (19.1 mm)	1-1/4" (31.8 mm)	2.5" (63.5 mm)	1" to 1/4" (25.4 to 6.4 mm)	2.0 lb (0.9 kg)
3213	17.375" (441.3 mm)	U.S. Heavy	7/8" (22.2 mm)	1-7/16" (36.5 mm)	3" (76.2 mm)	1-1/8" to 9/32" (28.6 to 7.1 mm)	2.7 lb (1.2 kg)
3214	18" (457.2 mm)	U.S. Heavy	1" (25.4 mm)	1-5/8" (41.3 mm)	3.625" (92.1 mm)	1-1/8" to 1/4" (28.6 to 6.4 mm)	3.4 lb (1.5 kg)
3219	14.75" (374.7 mm)	U.S. Regular	1/2" (12.7 mm)	3/4" (19.1 mm)	2.25" (57.2 mm)	7/8" x 1/2" (22.2 to 12.7 mm)	1.4 lb (0.6 kg)
3220	14.75" (374.7 mm)	U.S. Regular	1/2" (12.7 mm)	13/16" (20.6 mm)	2.25" (57.2 mm)	7/8" to 3/16" (22.2 to 4.8 mm)	1.4 lb (0.6 kg)
3221	14.75" (374.7 mm)	U.S. Regular	5/8" (15.9 mm)	1" (25.4 mm)	2.25" (57.2 mm)	7/8" to 3/16" (22.2 to 4.8 mm)	1.3 lb (0.6 kg)
3222	16.625" (422.3 mm)	U.S. Regular	3/4" (19.1 mm)	1-1/8" (28.6 mm)	2.5" (63.5 mm)	1" to 1/4" (25.4 to 6.4 mm)	2.0 lb (0.9 kg)
3223	17.375" (441.3 mm)	U.S. Regular	7/8" (22.2 mm)	1-5/16" (33.3 mm)	3" (76.2 mm)	1-1/8" to 9/32" (28.6 to 7.1 mm)	2.9 lb (1.3 kg)
3224	18" (457.2 mm)	U.S. Regular	1" (25.4 mm)	1-1/2" (38.1 mm)	3.625" (92.1 mm)	1-1/8" to 1/4" (28.6 to 6.4 mm)	3.4 lb (1.5 kg)
3231	14.75" (374.7 mm)	Utility	5/8" (15.9 mm)	15/16" (23.8 mm)	2.25" (57.2 mm)	7/8" to 3/16" (22.2 to 4.8 mm)	1.3 lb (0.6 kg)
3232	16.625" (422.3 mm)	Utility	3/4" (19.1 mm)	1-1/16" (27.0 mm)	2.5" (63.5 mm)	1" to 1/4" (25.4 to 6.4 mm)	2.0 lb (0.9 kg)

Erection wrenches with tether hole for working at height

3212TT	16.625" (422.3 mm)	U.S. Heavy	3/4" (19.1 mm)	1-1/4" (31.8 mm)	2.5" (63.5 mm)	1" to 1/4" (25.4 to 6.4 mm)	2.0 lb (0.9 kg)
3213TT	17.375" (441.3 mm)	U.S. Heavy	7/8" (22.2 mm)	1-7/16" (36.5 mm)	3" (76.2 mm)	1-1/8" to 9/32" (28.6 to 7.1 mm)	2.7 lb (1.2 kg)
3214TT	18" (457.2 mm)	U.S. Heavy	1" (25.4 mm)	1-5/8" (41.3 mm)	3.625" (92.1 mm)	1-1/8" to 1/4" (28.6 to 6.4 mm)	3.4 lb (1.5 kg)

See page 297 for additional information on warnings.



Strap Wrenches

Grip-It™ Strap Wrenches

- Completely adjustable strap wrench
- Works in the tightest quarters
- Urethane-covered, high-strength belting attached to lightweight, I-beam handle
- Cam-action design permits uniform, high-torque application
- Under normal conditions, will not scratch, damage or deform polished pipe and fittings, plastic pipe and fittings, oil and water filters, glass pipe, PVC conduit, or polished shafts
- Also works on alternator belts, flywheels, and propeller assemblies



S12H

Cat. No.	Handle Length	Diameter Capacity O.D.	Weight
S-6H	6" (152.4 mm)	1-1/2" to 5" (38.1 mm to 127.0 mm)	0.20 lb (0.09 kg)
S-12H	12" (304.8 mm)	1-1/2" to 5" (38.1 mm to 127.0 mm)	0.75 lb (0.34 kg)
S-18H	18" (457.2 mm)	1-1/8" to 8" (28.6 to 203.2 mm)	2.8 lb (1.3 kg)

Torque Wrenches

Micro-Adjustable Torque-Sensing Wrenches with Square-Drive Ratchet Head

- Micro-adjustable for increased accuracy
- Easy to read and adjust with quick release lever
- Stainless steel handle provides improved, more comfortable grip
- N.I.S.T. traceable calibration certificate meeting the ASME standard of $\pm 4\%$



57005

Cat. No.	Overall Length	Drive Size	Range	Weight
57000	14.125" (358.8 mm)	3/8" (9.5 mm)	10 to 100 ft. lb. (13.6 to 135.6 Nm)	2.0 lb (0.9 kg)
57005	10.625" (269.9 mm)	3/8" (9.5 mm)	30 to 250 in. lb. (3.4 to 28.3 Nm)	1.2 lb (0.5 kg)
57010	24.25" (616 mm)	1/2" (12.7 mm)	30 to 250 ft. lb. (40.7 to 340.0 Nm)	3.7 lb (1.7 kg)

Master Electrician's Torque Tool Kit

- Two micrometer-adjustable torque wrenches
- Nine hex-wrench bits
- Two 7/16" hex-wrench extensions
- One 7/16" female hex-wrench adapter coupler
- One hex-to-square adapter for wrenches and one adapter for screwdrivers
- One adjustable torque screwdriver
- Seven screwdriver bits; five slotted, two Phillips
- Hinged metal box
- Additional torque screwdrivers available in screwdriver section



57060

Cat. No.	Description	Weight
57060	Master Electrician's Torque Kit 25-Piece	9.6 lb (4.3 kg)





Hex-Key Wrenches

Klein hex-keys are the tools professionals cannot afford to be without. Heat-treated and tempered for superior strength and durability, Klein hex-keys are designed for a precise fit in sockets, preventing slippage and stripping of the socket.

For Professionals...
Since 1857™

JOURNEYMAN

T-Handle Hex-Keys

Tip-Ident™
sizes marked

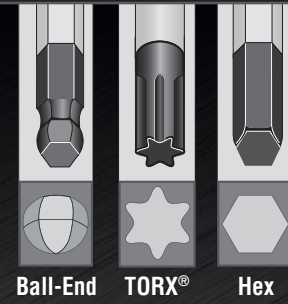
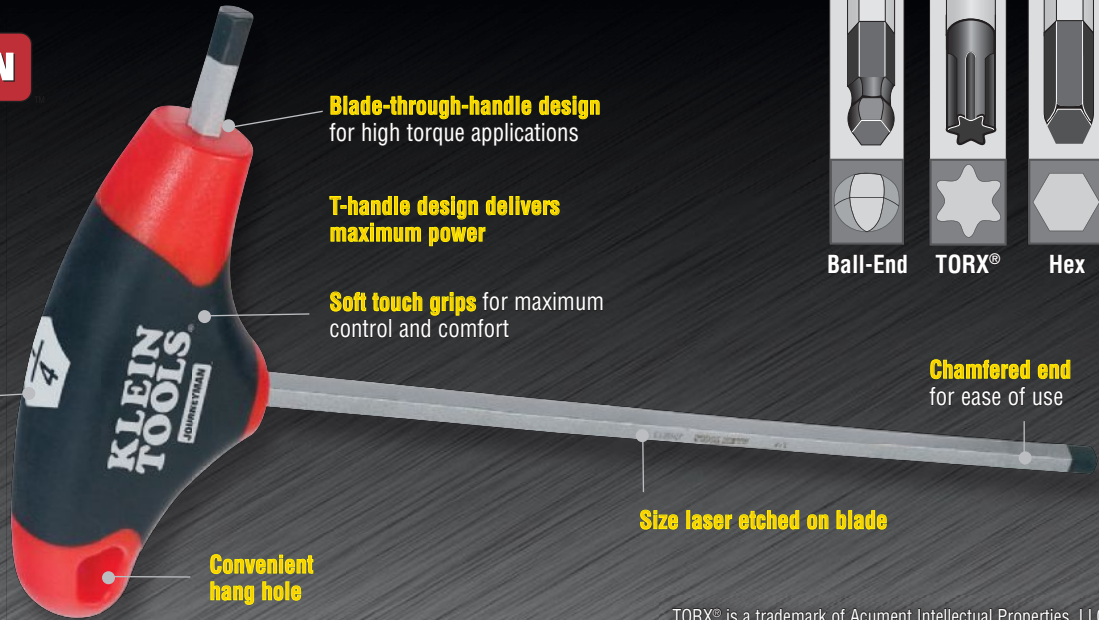

TORX® is a trademark of Acument Intellectual Properties, LLC.

T-Handle Ball-End Hex-Keys - SAE

Includes core Journeyman™ T-handle hex-key features plus:

- Short blade-through-handle provides maximum tool versatility



JTH6E13BE

Cat. No.	Hex Size	Blade Length	Weight
JTH6E06BE	3/32"	6" (152.4 mm)	0.64 oz (18.1 g)
JTH6E07BE	7/64"	6" (152.4 mm)	0.80 oz (22.7 g)
JTH6E08BE	1/8"	6" (152.4 mm)	1.0 oz (28 g)
JTH6E09BE	9/64"	6" (152.4 mm)	1.1 oz (31 g)
JTH6E10BE	5/32"	6" (152.4 mm)	0.12 lb (0.05 kg)
JTH6E11BE	3/16"	6" (152.4 mm)	0.14 lb (0.06 kg)

Cat. No.	Hex Size	Blade Length	Weight
JTH6E12BE	7/32"	6" (152.4 mm)	0.17 lb (0.08 kg)
JTH6E13BE	1/4"	6" (152.4 mm)	0.27 lb (0.12 kg)
JTH6E14BE	5/16"	6" (152.4 mm)	0.35 lb (0.16 kg)
JTH6E15BE	3/8"	6" (152.4 mm)	0.45 lb (0.20 kg)
JTH6E17BE	1/2"	6" (152.4 mm)	0.70 lb (0.32 kg)

T-Handle Ball-End Hex-Key Set with Stand - SAE

Includes core Journeyman™ T-handle hex-key features plus:

- Metal stand for convenient hanging, storage on bench or wall
- Short blade-through-handle provides maximum tool versatility

Cat. No.	Set Contains	Weight																																	
JTH610EB	<table border="1"> <thead> <tr> <th>Cat. No.</th> <th>Hex Size</th> <th>Blade Length</th> </tr> </thead> <tbody> <tr> <td>JTH6E06BE</td> <td>3/32"</td> <td>6" (152.4 mm)</td> </tr> <tr> <td>JTH6E07BE</td> <td>7/64"</td> <td>6" (152.4 mm)</td> </tr> <tr> <td>JTH6E08BE</td> <td>1/8"</td> <td>6" (152.4 mm)</td> </tr> <tr> <td>JTH6E09BE</td> <td>9/64"</td> <td>6" (152.4 mm)</td> </tr> <tr> <td>JTH6E10BE</td> <td>5/32"</td> <td>6" (152.4 mm)</td> </tr> <tr> <td>JTH6E11BE</td> <td>3/16"</td> <td>6" (152.4 mm)</td> </tr> <tr> <td>JTH6E12BE</td> <td>7/32"</td> <td>6" (152.4 mm)</td> </tr> <tr> <td>JTH6E13BE</td> <td>1/4"</td> <td>6" (152.4 mm)</td> </tr> <tr> <td>JTH6E14BE</td> <td>5/16"</td> <td>6" (152.4 mm)</td> </tr> <tr> <td>JTH6E15BE</td> <td>3/8"</td> <td>6" (152.4 mm)</td> </tr> </tbody> </table>	Cat. No.	Hex Size	Blade Length	JTH6E06BE	3/32"	6" (152.4 mm)	JTH6E07BE	7/64"	6" (152.4 mm)	JTH6E08BE	1/8"	6" (152.4 mm)	JTH6E09BE	9/64"	6" (152.4 mm)	JTH6E10BE	5/32"	6" (152.4 mm)	JTH6E11BE	3/16"	6" (152.4 mm)	JTH6E12BE	7/32"	6" (152.4 mm)	JTH6E13BE	1/4"	6" (152.4 mm)	JTH6E14BE	5/16"	6" (152.4 mm)	JTH6E15BE	3/8"	6" (152.4 mm)	3.0 lb (1.4 kg)
Cat. No.	Hex Size	Blade Length																																	
JTH6E06BE	3/32"	6" (152.4 mm)																																	
JTH6E07BE	7/64"	6" (152.4 mm)																																	
JTH6E08BE	1/8"	6" (152.4 mm)																																	
JTH6E09BE	9/64"	6" (152.4 mm)																																	
JTH6E10BE	5/32"	6" (152.4 mm)																																	
JTH6E11BE	3/16"	6" (152.4 mm)																																	
JTH6E12BE	7/32"	6" (152.4 mm)																																	
JTH6E13BE	1/4"	6" (152.4 mm)																																	
JTH6E14BE	5/16"	6" (152.4 mm)																																	
JTH6E15BE	3/8"	6" (152.4 mm)																																	



JTH610EB



JOURNEYMAN™

T-Handle Hex-Keys

T-Handle Hex-Keys - SAE

Includes core Journeyman™ T-handle hex-key features plus:

- Short blade-through-handle provides maximum tool versatility



JTH6E15

Cat. No.	Hex Size	Blade Length	Weight
4" Length			
JTH4E06	3/32"	4" (101.6 mm)	0.05 oz (1.4 g)
JTH4E07	7/64"	4" (101.6 mm)	0.05 oz (1.4 g)
JTH4E08	1/8"	4" (101.6 mm)	0.05 oz (1.4 g)
JTH4E09	9/64"	4" (101.6 mm)	0.06 oz (1.7 g)
JTH4E10	5/32"	4" (101.6 mm)	0.11 oz (3.1 g)
JTH4E11	3/16"	4" (101.6 mm)	0.13 oz (3.7 g)
JTH4E12	7/32"	4" (101.6 mm)	0.14 oz (4.0 g)
JTH4E13	1/4"	4" (101.6 mm)	0.24 oz (6.8 g)
JTH4E14	5/16"	4" (101.6 mm)	0.30 oz (8.5 g)
JTH4E15	3/8"	4" (101.6 mm)	0.38 oz (10.8 g)
JTH4E17	1/2"	4" (101.6 mm)	0.59 oz (16.7 g)
6" Length			
JTH6E06	3/32"	6" (152.4 mm)	0.05 oz (1.4 g)
JTH6E07	7/64"	6" (152.4 mm)	0.05 oz (1.4 g)
JTH6E08	1/8"	6" (152.4 mm)	0.05 oz (1.4 g)
JTH6E09	9/64"	6" (152.4 mm)	0.06 oz (1.7 g)
JTH6E10	5/32"	6" (152.4 mm)	0.11 oz (3.1 g)
JTH6E11	3/16"	6" (152.4 mm)	0.13 oz (3.7 g)
JTH6E12	7/32"	6" (152.4 mm)	0.14 oz (4.0 g)
JTH6E13	1/4"	6" (152.4 mm)	0.24 oz (6.8 g)
JTH6E14	5/16"	6" (152.4 mm)	0.30 oz (8.5 g)
JTH6E15	3/8"	6" (152.4 mm)	0.38 oz (10.8 g)
JTH6E17	1/2"	6" (152.4 mm)	0.59 oz (16.7 g)
9" Length			
JTH9E06	3/32"	9" (228.6 mm)	0.05 oz (1.4 g)
JTH9E07	7/64"	9" (228.6 mm)	0.05 oz (1.4 g)
JTH9E08	1/8"	9" (228.6 mm)	0.06 oz (1.7 g)
JTH9E09	9/64"	9" (228.6 mm)	0.06 oz (1.7 g)
JTH9E10	5/32"	9" (228.6 mm)	0.11 oz (3.1 g)
JTH9E11	3/16"	9" (228.6 mm)	0.14 oz (4.0 g)
JTH9E12	7/32"	9" (228.6 mm)	0.18 oz (5.1 g)
JTH9E13	1/4"	9" (228.6 mm)	0.27 oz (7.7 g)
JTH9E14	5/16"	9" (228.6 mm)	0.35 oz (9.9 g)
JTH9E15	3/8"	9" (228.6 mm)	0.45 oz (12.8 g)
JTH9E17	1/2"	9" (228.6 mm)	0.70 oz (19.8 g)

T-Handle Hex-Key Sets with Stand - SAE

Includes core Journeyman™ T-handle hex-key features plus:

- Metal stand for convenient mounting on bench or wall
- Short blade-through-handle provides maximum tool versatility



JTH610E

Cat. No.	Set Contains	Weight
JTH410E	SAE T-Handle Hex Key Set, Stand, 4", 10-Piece	2.7 lb (1.2 kg)

Cat. No.	Hex Size	Blade Length
JTH4E06	3/32"	4" (101.6 mm)
JTH4E07	7/64"	4" (101.6 mm)
JTH4E08	1/8"	4" (101.6 mm)
JTH4E09	9/64"	4" (101.6 mm)
JTH4E10	5/32"	4" (101.6 mm)
JTH4E11	3/16"	4" (101.6 mm)
JTH4E12	7/32"	4" (101.6 mm)
JTH4E13	1/4"	4" (101.6 mm)
JTH4E14	5/16"	4" (101.6 mm)
JTH4E15	3/8"	4" (101.6 mm)

Cat. No.	Set Contains	Weight
JTH610E	T-Handle Set with Stand, SAE, 6" Blade 10 Pc	2.7 lb (1.2 kg)

Cat. No.	Hex Size	Blade Length
JTH6E06	3/32"	6" (152.4 mm)
JTH6E07	7/64"	6" (152.4 mm)
JTH6E08	1/8"	6" (152.4 mm)
JTH6E09	9/64"	6" (152.4 mm)
JTH6E10	5/32"	6" (152.4 mm)
JTH6E11	3/16"	6" (152.4 mm)
JTH6E12	7/32"	6" (152.4 mm)
JTH6E13	1/4"	6" (152.4 mm)
JTH6E14	5/16"	6" (152.4 mm)
JTH6E15	3/8"	6" (152.4 mm)

Cat. No.	Set Contains	Weight
JTH910E	T-Handle Set with Stand, SAE, 9" Blade 10 Pc	3.6 lb (1.6 kg)

Cat. No.	Hex Size	Blade Length
JTH9E06	3/32"	9" (228.6 mm)
JTH9E07	7/64"	9" (228.6 mm)
JTH9E08	1/8"	9" (228.6 mm)
JTH9E09	9/64"	9" (228.6 mm)
JTH9E10	5/32"	9" (228.6 mm)
JTH9E11	3/16"	9" (228.6 mm)
JTH9E12	7/32"	9" (228.6 mm)
JTH9E13	1/4"	9" (228.6 mm)
JTH9E14	5/16"	9" (228.6 mm)
JTH9E15	3/8"	9" (228.6 mm)

See page 297 for additional information on warnings.



JOURNEYMAN

T-Handle Hex-Keys

T-Handle Ball-End Hex-Keys - Metric

Includes core Journeyman™ T-handle hex-key features plus:

- Short blade-through-handle provides maximum tool versatility

Cat. No.	Hex Size	Blade Length	Weight
JTH6M2BE	2 mm	6" (152.4 mm)	0.64 oz (18.1 g)
JTH6M25BE	2.5 mm	6" (152.4 mm)	0.80 oz (22.7 g)
JTH6M3BE	3 mm	6" (152.4 mm)	1.0 oz (28 g)
JTH6M4BE	4 mm	6" (152.4 mm)	1.1 oz (31 g)
JTH6M5BE	5 mm	6" (152.4 mm)	0.15 lb (0.07 kg)
JTH6M6BE	6 mm	6" (152.4 mm)	0.19 lb (0.09 kg)
JTH6M8BE	8 mm	6" (152.4 mm)	0.35 lb (0.16 kg)
JTH6M10BE	10 mm	6" (152.4 mm)	0.48 lb (0.22 kg)



JTH6M8BE

T-Handle Ball-End Hex-Key Set with Stand - Metric

Includes core Journeyman™ T-handle hex-key features plus:

- Metal stand for convenient mounting on bench or wall
- Short blade-through-handle provides maximum tool versatility

Cat. No.	Set Contains	Weight
JTH68MB		2.7 lb (1.2 kg)

Cat. No.	Hex Size	Blade Length
JTH6M2BE	2 mm	6" (152.4 mm)
JTH6M25BE	2.5 mm	6" (152.4 mm)
JTH6M3BE	3 mm	6" (152.4 mm)
JTH6M4BE	4 mm	6" (152.4 mm)
JTH6M5BE	5 mm	6" (152.4 mm)
JTH6M6BE	6 mm	6" (152.4 mm)
JTH6M8BE	8 mm	6" (152.4 mm)
JTH6M10BE	10 mm	6" (152.4 mm)



JTH68MB

T-Handle Hex-Keys - Metric

Includes core Journeyman™ T-handle hex-key features plus:

- Short blade-through-handle provides maximum tool versatility

Cat. No.	Hex Size	Blade Length	Weight
6" Length			
JTH6M2	2 mm	6" (152.4 mm)	0.64 oz (18.1 g)
JTH6M25	2.5 mm	6" (152.4 mm)	0.80 oz (22.7 g)
JTH6M3	3 mm	6" (152.4 mm)	1.0 oz (28 g)
JTH6M4	4 mm	6" (152.4 mm)	0.10 oz (2.8 g)
JTH6M5	5 mm	6" (152.4 mm)	0.15 lb (0.07 kg)
JTH6M6	6 mm	6" (152.4 mm)	0.17 lb (0.08 kg)
JTH6M8	8 mm	6" (152.4 mm)	0.35 lb (0.16 kg)
JTH6M10	10 mm	6" (152.4 mm)	0.48 lb (0.22 kg)
9" Length			
JTH9M10	10 mm	9" (228.6 mm)	0.48 oz (13.6 g)
JTH9M2	2 mm	9" (228.6 mm)	0.05 oz (1.4 g)
JTH9M25	2.5 mm	9" (228.6 mm)	0.05 oz (1.4 g)
JTH9M3	3 mm	9" (228.6 mm)	0.06 oz (1.7 g)
JTH9M4	4 mm	9" (228.6 mm)	1.4 oz (40 g)
JTH9M5	5 mm	9" (228.6 mm)	0.18 oz (5.1 g)
JTH9M6	6 mm	9" (228.6 mm)	0.22 oz (6.2 g)
JTH9M8	8 mm	9" (228.6 mm)	0.42 oz (11.9 g)



JTH6M8





JOURNEYMAN™

T-Handle Hex-Keys

T-Handle Hex-Key Sets with Stand - Metric

Includes core Journeyman™ T-handle hex-key features plus:

- Metal stand for convenient mounting on bench or wall
- Short blade-through-handle provides maximum tool versatility



JTH68M

Cat. No.	Set Contains	Weight
JTH68M	Journeyman™ T-Handle Set, Metric, 6", 8-Piece	1.8 lb (0.8 kg)
Cat. No.	Hex Size	Blade Length
JTH6M2	2 mm	6" (152.4 mm)
JTH6M25	2.5 mm	6" (152.4 mm)
JTH6M3	3 mm	6" (152.4 mm)
JTH6M4	4 mm	6" (152.4 mm)
JTH6M5	5 mm	6" (152.4 mm)
JTH6M6	6 mm	6" (152.4 mm)
JTH6M8	8 mm	6" (152.4 mm)
JTH6M10	10 mm	6" (152.4 mm)

Cat. No.	Set Contains	Weight
JTH98M	9" Metric Journeyman T-Handle Set 8 Piece	2.1 lb (1.0 kg)
Cat. No.	Hex Size	Blade Length
JTH9M2	2 mm	9" (228.6 mm)
JTH9M25	2.5 mm	9" (228.6 mm)
JTH9M3	3 mm	9" (228.6 mm)
JTH9M4	4 mm	9" (228.6 mm)
JTH9M5	5 mm	9" (228.6 mm)
JTH9M6	6 mm	9" (228.6 mm)
JTH9M8	8 mm	9" (228.6 mm)
JTH9M10	10 mm	9" (228.6 mm)

T-Handle Hex-Keys - TORX®

Includes core Journeyman™ T-handle hex-key features plus:

- Short blade-through-handle provides maximum tool versatility

Cat. No.	Hex Size	Blade Length	Weight
JTH6T10	T10	6" (152.4 mm)	0.80 oz (22.7 g)
JTH6T15	T15	6" (152.4 mm)	1.0 oz (28 g)
JTH6T20	T20	6" (152.4 mm)	1.1 oz (31 g)
JTH6T25	T25	6" (152.4 mm)	0.13 lb (0.06 kg)
JTH6T27	T27	6" (152.4 mm)	0.16 lb (0.07 kg)
JTH6T30	T30	6" (152.4 mm)	0.18 lb (0.08 kg)
JTH6T40	T40	6" (152.4 mm)	0.29 lb (0.13 kg)

TORX® is a trademark of Acument Intellectual Properties, LLC.



JTH6T40

T-Handle Hex-Key Set with Stand - TORX®

Includes core Journeyman™ T-handle hex-key features plus:

- Metal stand for convenient mounting on bench or wall
- Short blade-through-handle provides maximum tool versatility

Cat. No.	Set Contains	Weight
JTH67T	TORX T-Handle Hex Key Set and Stand, 6", 7-Pc	1.3 lb (0.6 kg)
Cat. No.	Hex Size	Blade Length
JTH6T10	T10	6" (152.4 mm)
JTH6T15	T15	6" (152.4 mm)
JTH6T20	T20	6" (152.4 mm)
JTH6T25	T25	6" (152.4 mm)
JTH6T27	T27	6" (152.4 mm)
JTH6T30	T30	6" (152.4 mm)
JTH6T40	T40	6" (152.4 mm)

TORX® is a trademark of Acument Intellectual Properties, LLC.



JTH67T



Folding Hex-Key Sets

Hex-Key Sets

- Two key positions (straight-out or right angle) for extra leverage
- Hex ends are square-cut for a secure full-depth fit and maximum contact with the hex socket to prevent slippage and stripping of the socket
- Handy sets fit in your pocket or tool box easily and help eliminate the lost key problem
- Made in the U.S.A.



70579

Cat. No.	Description	Size	Handle Length	Key Lengths	Color	Weight
70591	Folding Hex Key Set, Nine-Key, Inch Sizes	5/64", 3/32", 7/64", 1/8", 9/64", 5/32", 3/16", 7/32", 1/4"	4.375" (111.1 mm)	2.688 to 3.813" (68.3 to 96.9 mm)	Silver	0.50 lb (0.23 kg)
70581	8-Key Folding Hex Key Set, 1/20 to 5/32" SAE	1/20", 1/16", 5/64", 3/32", 7/64", 1/8", 9/64", 5/32"	3.063" (77.8 mm)	1.875 to 3" (47.6 to 76.2 mm)	Silver	0.20 lb (0.09 kg)
70579	Folding Hex Key Set, 5", SAE, 5-Piece	3/16", 7/32", 1/4", 5/16", 3/8"	5.375" (136.5 mm)	2.688 to 3.813" (68.3 to 96.9 mm)	Silver	0.85 lb (0.39 kg)
70582	Seven-Key Metric Folding Hex Key Set	1-1/2 mm, 2 mm, 2-1/2 mm, 3 mm, 4 mm, 5 mm, 6 mm	3.703" (94.1 mm)	0.594 to 1.781" (15.1 to 45.2 mm)	Silver	0.27 lb (0.12 kg)
70580	Folding Hex Key Set, Six-Key, Metric Sizes	3 mm, 4 mm, 5 mm, 6 mm, 8 mm, 10 mm	5.375" (136.5 mm)	2.375 to 4" (60.3 to 101.6 mm)	Silver	0.85 lb (0.39 kg)

Grip-It™ Hex-Key Sets

- Blades rotate independently up to 270°
- Precision fit so hex tool end reduces stripping problems. Keys are industrial strength, impact-resistant and tested for performance to below freezing
- Glass-reinforced nylon handle
- Hex ends are square-cut for a secure full-depth fit and maximum contact with the hex socket to prevent slippage and stripping of the socket (Cat. Nos. 70570, 70573, 70574, and 70575)
- Ball design allows for a thicker neck diameter increasing torque capacity, while maintaining operational angles to 25% (Cat. Nos. 70571 and 70572)
- Made in the U.S.A.



70570

Cat. No.	Description	Size	Handle Length	Key Lengths	Color	Weight
70571	Grip-It® Ball End Hex Key Set, 5 Key, Inch Sizes	3/16", 7/32", 1/4", 5/16", 3/8"	4.438" (112.7 mm)	1.547 to 2" (39.3 to 50.8 mm)	Yellow	0.58 lb (0.26 kg)
70572	Grip-It® Five Key Ball Hex Set - Metric	5 mm, 6 mm, 7 mm, 8 mm, 10 mm	4.438" (112.7 mm)	1.594 to 1.938" (40.5 to 49.2 mm)	Red	0.58 lb (0.26 kg)
70573	Grip-It® 12 Key Hex Set - Inch/Metric	5/64", 3/32", 7/64", 1/8", 9/64", 5/32", 1.5 mm, 2 mm, 2.5 mm, 3 mm, 4 mm, 5 mm	4.438" (112.7 mm)	1.438 to 2.266" (36.5 to 57.6 mm)	Blue	0.30 lb (0.14 kg)
70574	Grip-It Nine Key Hex Set with 2 Positions	5/64", 3/32", 7/64", 1/8", 9/64", 5/32", 3/16", 7/32", 1/4"	4.438" (112.7 mm)	1.75 to 2.266" (44.5 to 57.6 mm)	Yellow	0.33 lb (0.15 kg)
70575	Grip-It® Nine Key Hex Set Square Cut	3/64", 1/16", 5/64", 3/32", 7/64", 1/8", 9/64", 5/32", 3/16"	3.813" (96.9 mm)	1.391 to 1.844" (35.3 to 46.8 mm)	Yellow	0.20 lb (0.09 kg)

TORX® Sets

Folding TORX® Set

- TORX® drive cuts slippage, saves fasteners, efficiently transmits more torque to the work
- Keys are tough, heat-treated chrome-nickel alloy steel for strength and durability
- Keys fold flat into handle
- Can be used straight out or at an angle for extra leverage



70586

Cat. No.	Size	Handle Length	Key Lengths	Color	Weight
70586	T10, T15, T20, T25, T27, T30, T40	4.375" (111.1 mm)	2.813 to 3" (71.5 to 76.2 mm)	Silver	0.30 lb (0.14 kg)

TORX® is a trademark of Acument Intellectual Properties, LLC.



Hex-Key Wrenches

L-Style Hex-Keys

Rust and corrosion resistant surfaces

Top-grade alloy steel

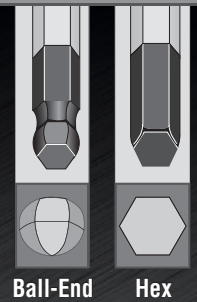

L-Style Hex-Keys

LL8

Cat. No.	Hex Size	Short Arm Length	Long Arm Length	Weight
LL2	0.050"	0.563" (14.3 mm)	2.875" (73 mm)	0.08 oz (2.3 g)
LL4	1/16"	0.625" (15.9 mm)	3.063" (77.8 mm)	0.08 oz (2.3 g)
LL5	5/64"	0.688" (17.5 mm)	3.25" (82.6 mm)	0.08 oz (2.3 g)
LL6	3/32"	0.75" (19.1 mm)	3.5" (88.9 mm)	0.16 oz (4.5 g)
LL7	7/64"	0.813" (20.7 mm)	3.688" (93.7 mm)	0.32 oz (9.1 g)
LL8	1/8"	0.875" (22.2 mm)	3.875" (98.4 mm)	0.32 oz (9.1 g)
LL9	9/64"	0.938" (23.8 mm)	4.125" (104.8 mm)	0.48 oz (13.6 g)
LL10	5/32"	1" (25.4 mm)	4.375" (111.1 mm)	0.48 oz (13.6 g)
LL12	3/16"	1.125" (28.6 mm)	4.688" (119.1 mm)	0.80 oz (22.7 g)
LL14	7/32"	1.25" (31.8 mm)	5.063" (128.6 mm)	0.70 lb (0.32 kg)
LL16	1/4"	1.375" (34.9 mm)	5.5" (139.7 mm)	0.10 lb (0.05 kg)
LL20	5/16"	1.563" (39.7 mm)	6.313" (160.4 mm)	0.18 lb (0.08 kg)
LL24	3/8"	1.75" (44.5 mm)	7.125" (181 mm)	0.25 lb (0.11 kg)
Metric				
LLM15	1.5 mm	0.563" (14.3 mm)	3.125" (79.4 mm)	0.08 oz (2.3 g)
LLM2	2 mm	0.688" (17.5 mm)	3.031" (77 mm)	0.08 oz (2.3 g)
LLM25	2.5 mm	0.813" (20.7 mm)	3.563" (90.5 mm)	0.16 oz (4.5 g)
LLM3	3 mm	0.875" (22.2 mm)	4" (101.6 mm)	0.32 oz (9.1 g)
LLM4	4 mm	1" (25.4 mm)	4.5" (114.3 mm)	0.48 oz (13.6 g)
LLM5	5 mm	1.25" (31.8 mm)	4.875" (123.8 mm)	0.80 oz (22.7 g)
LLM6	6 mm	1.438" (36.5 mm)	5.688" (144.5 mm)	1.3 oz (37 g)
LLM8	8 mm	1.688" (42.9 mm)	6.313" (160.4 mm)	0.15 lb (0.07 kg)
LLM10	10 mm	1.938" (49.2 mm)	7.125" (181 mm)	0.25 lb (0.11 kg)

L-Style Ball-End Hex-Keys

BL8

Includes core L-Style hex key features plus:

- Allows easy access, even in restricted areas
- Ball-end works on angles up to 30°

Cat. No.	Hex Size	Short Arm Length	Long Arm Length	Weight
BL2	0.050"	0.563" (14.3 mm)	2.875" (73 mm)	0.03 oz (0.9 g)
BL4	1/16"	0.625" (15.9 mm)	3.063" (77.8 mm)	0.03 oz (0.9 g)
BL5	5/64"	0.688" (17.5 mm)	3.25" (82.6 mm)	0.08 oz (2.3 g)
BL6	3/32"	0.75" (19.1 mm)	3.5" (88.9 mm)	0.08 oz (2.3 g)
BL7	7/64"	0.75" (19.1 mm)	3.688" (93.7 mm)	0.16 oz (4.5 g)
BL8	1/8"	0.875" (22.2 mm)	3.875" (98.4 mm)	0.32 oz (9.1 g)
BL9	9/64"	0.938" (23.8 mm)	4.125" (104.8 mm)	0.32 oz (9.1 g)
BL10	5/32"	1" (25.4 mm)	4.375" (111.1 mm)	0.48 oz (13.6 g)
BL12	3/16"	1.125" (28.6 mm)	4.688" (119.1 mm)	0.80 oz (22.7 g)
BL14	7/32"	1.25" (31.8 mm)	5.063" (128.6 mm)	1.0 oz (28 g)
BL16	1/4"	1.375" (34.9 mm)	5.813" (147.7 mm)	1.4 oz (40 g)
BL20	5/16"	1.563" (39.7 mm)	6.313" (160.4 mm)	0.17 lb (0.08 kg)
BL24	3/8"	1.75" (44.5 mm)	7.125" (181 mm)	0.23 lb (0.10 kg)
Metric				
BLM15	1.5 mm	0.563" (14.3 mm)	3.063" (77.8 mm)	0.16 oz (4.5 g)
BLM2	2 mm	0.688" (17.5 mm)	3.313" (84.2 mm)	0.16 oz (4.5 g)
BLM25	2.5 mm	0.813" (20.7 mm)	3.563" (90.5 mm)	0.16 oz (4.5 g)
BLM3	3 mm	0.875" (22.2 mm)	4" (101.6 mm)	0.32 oz (9.1 g)
BLM4	4 mm	1" (25.4 mm)	4.5" (114.3 mm)	0.48 oz (13.6 g)
BLM5	5 mm	1.25" (31.8 mm)	4.875" (123.8 mm)	0.80 oz (22.7 g)
BLM6	6 mm	1.438" (36.5 mm)	5.688" (144.5 mm)	1.3 oz (37 g)
BLM8	8 mm	1.688" (42.9 mm)	6.313" (160.4 mm)	0.14 lb (0.06 kg)
BLM10	10 mm	1.938" (49.2 mm)	6.125" (155.6 mm)	0.24 lb (0.11 kg)

See page 297 for additional information on warnings.



L-Style Hex-Key Sets

L-Style Caddy Sets

Includes core L-Style hex key features plus:

- L-style hex-keys organized in convenient, durable caddy sets
- Each set contains a unique locking feature and marked slots for each key
- Ball-end works on angles up to 30° (Cat. Nos. BLK12 and BLMK10)



BLK12



LMK10

Cat. No.	Set Contains	Weight
BLK12	L Style Ball End Hex Key Caddy Set 12-Piece	0.53 lb (0.24 kg)

Cat. No.	Hex Size	Short Arm Length	Long Arm Length
BL2	0.050"	0.563" (14.3 mm)	2.875" (73 mm)
BL4	1/16"	0.625" (15.9 mm)	3.063" (77.8 mm)
BL5	5/64"	0.688" (17.5 mm)	3.25" (82.6 mm)
BL6	3/32"	0.75" (19.1 mm)	3.5" (88.9 mm)
BL7	7/64"	0.75" (19.1 mm)	3.688" (93.7 mm)
BL8	1/8"	0.875" (22.2 mm)	3.875" (98.4 mm)
BL9	9/64"	0.938" (23.8 mm)	4.125" (104.8 mm)
BL10	5/32"	1" (25.4 mm)	4.375" (111.1 mm)
BL12	3/16"	1.125" (28.6 mm)	4.688" (119.1 mm)
BL14	7/32"	1.25" (31.8 mm)	5.063" (128.6 mm)
BL16	1/4"	1.375" (34.9 mm)	5.813" (147.7 mm)
BL20	5/16"	1.563" (39.7 mm)	6.313" (160.4 mm)

Cat. No.	Set Contains	Weight
BLMK10	L Style Ball End Hex Key Caddy Set Metric 9-Piece	0.62 lb (0.28 kg)

Cat. No.	Hex Size	Short Arm Length	Long Arm Length
BLM15	1.5 mm	0.563" (14.3 mm)	3.063" (77.8 mm)
BLM2	2 mm	0.688" (17.5 mm)	3.313" (84.2 mm)
BLM25	2.5 mm	0.813" (20.7 mm)	3.563" (90.5 mm)
BLM3	3 mm	0.875" (22.2 mm)	4" (101.6 mm)
BLM4	4 mm	1" (25.4 mm)	4.5" (114.3 mm)
BLM5	5 mm	1.25" (31.8 mm)	4.875" (123.8 mm)
BLM6	6 mm	1.438" (36.5 mm)	5.688" (144.5 mm)
BLM8	8 mm	1.688" (42.9 mm)	6.313" (160.4 mm)
BLM10	10 mm	1.938" (49.2 mm)	6.125" (155.6 mm)

Cat. No.	Set Contains	Weight
LLK12	L-Style Hex Key Caddy Set 12-Piece	0.54 lb (0.24 kg)

Cat. No.	Hex Size	Short Arm Length	Long Arm Length
LL2	0.050"	0.563" (14.3 mm)	2.875" (73 mm)
LL4	1/16"	0.625" (15.9 mm)	3.063" (77.8 mm)
LL5	5/64"	0.688" (17.5 mm)	3.25" (82.6 mm)
LL6	3/32"	0.75" (19.1 mm)	3.5" (88.9 mm)
LL7	7/64"	0.813" (20.7 mm)	3.688" (93.7 mm)
LL8	1/8"	0.875" (22.2 mm)	3.875" (98.4 mm)
LL9	9/64"	0.938" (23.8 mm)	4.125" (104.8 mm)
LL10	5/32"	1" (25.4 mm)	4.375" (111.1 mm)
LL12	3/16"	1.125" (28.6 mm)	4.688" (119.1 mm)
LL14	7/32"	1.25" (31.8 mm)	5.063" (128.6 mm)
LL16	1/4"	1.375" (34.9 mm)	5.5" (139.7 mm)
LL20	5/16"	1.563" (39.7 mm)	6.313" (160.4 mm)

Cat. No.	Set Contains	Weight
LMK10	L-Style Hex Key Caddy Set Metric, 9-Piece	0.63 lb (0.29 kg)

Cat. No.	Hex Size	Short Arm Length	Long Arm Length
LLM15	1.5 mm	0.563" (14.3 mm)	3.125" (79.4 mm)
LLM2	2 mm	0.688" (17.5 mm)	3.031" (77 mm)
LLM25	2.5 mm	0.813" (20.7 mm)	3.563" (90.5 mm)
LLM3	3 mm	0.875" (22.2 mm)	4" (101.6 mm)
LLM4	4 mm	1" (25.4 mm)	4.5" (114.3 mm)
LLM5	5 mm	1.25" (31.8 mm)	4.875" (123.8 mm)
LLM6	6 mm	1.438" (36.5 mm)	5.688" (144.5 mm)
LLM8	8 mm	1.688" (42.9 mm)	6.313" (160.4 mm)
LLM10	10 mm	1.938" (49.2 mm)	7.125" (181 mm)



Levels and Measuring Tools

Klein offers a variety of levels and other measuring devices that are precise and easy to use for any layout application. Built to withstand tough jobsite conditions, Klein's innovative designs and patented technology will help you get the job done right.

For Professionals...
Since 1857™

Cross-Line Laser Levels

Self-leveling,
easy-to-read
**horizontal
& vertical**
laser lines

IP54: water and dust resistant

Integrated magnetic 360° mounting bracket with 1/4" and 5/8" tripod mounting threads



Projects horizontal and vertical lines independently or together for various alignments

Plumb spot lasers to pinpoint overhead locations (model 93LCLS only)

Laser Line Levels

Includes core laser level features plus:

- Additional mounting clamp attachment for use on ceiling grid applications
- Molded hard carrying case included



Cat. No.	Plumb Laser	Accuracy	Overall Length	Overall Height	Overall Width	Weight
93LCL	No	$\pm 3/32"$ per 33 ft (± 2 mm per 10 m)	2.625" (66.7 mm)	5" (127.0 mm)	5.25" (133.4 mm)	1.6 lb (0.7 kg) without Batteries
93LCLS	Yes	$\pm 3/32"$ per 33 ft (± 2 mm per 10 m)	2.625" (66.7 mm)	5" (127.0 mm)	5.25" (133.4 mm)	1.6 lb (0.7 kg) without Batteries

Accu-Bend™ Aluminum Levels

Prevents dog legs in conduit bends



Tapered Nose easily slides into pockets and fits in tighter spaces

Top V-Groove fits contour of pipe



Brass thumb screw for hands-free leveling when bending conduit



Large, high visibility vials are easy to read

Patented
MAGNET TRACK

ULTRA POWERFUL
Rare Earth Magnets 



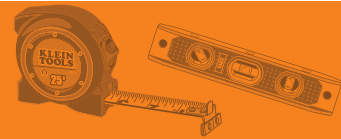

Levels

Accu-Bend™ Aluminum Levels

- Tapered nose easily slides into pockets and fits in tighter spaces
- Patented magnet track keeps powerful rare earth magnets in place
- Top V-Groove fits contour of conduit and pipe
- Thumb screw attaches level to conduit to measure angle while bending
- Cat. No. 935AB1V is non-magnetic



Cat. No.	Number of Vials	Type of Vials	Overall Length	Weight
935AB4V	4	0°, 90°, 45°, 30°	6.25" (158.8 mm)	0.37 lb (0.17 kg)
935AB1V	1	0°	2.5" (63.5 mm)	0.15 lb (0.07 kg)



935AB4V

⚠ WARNING: Brass bolt contains lead, a chemical known to the State of California to cause cancer, and birth defects or other reproductive harm. Wash hands after handling.



935AB1V

Billet Aluminum Torpedo Levels

- Tapered nose easily slides into pockets and fits in tighter space
- Patented magnet track keeps powerful rare earth magnets in place
- Top V-Groove fits contour of conduit and pipe
- Cat. No. 935RBLT features large, easy to read bright LED high-definition vials for any lighting condition, a 3-minute auto-shut-off to save batter life, and is water and impact resistant

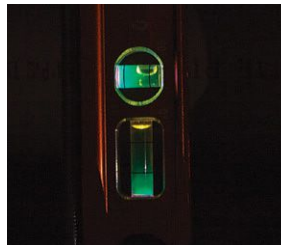

Super Bright High-Definition LED Vials (Cat No. 935RBLT)

Cat. No.	Number of Vials	Type of Vials	Overall Length	Weight
935RBLT	3	0°, 90°, 45°	9" (228.6 mm)	0.70 lb (0.32 kg)
935RB	4	0°, 90°, 45°, 30°	8" (203.2 mm)	0.46 lb (0.21 kg)



935RBLT



935RB

Aluminum Torpedo Levels

- Aluminum frame with orange body for added visibility and durability
- Patented magnet track keeps powerful rare earth magnets in place
- Top V-groove fits contour of conduit and pipe
- Large high-visibility vials are easy to read
- Cat. No. 931-9RETT has tether ring for working at height
- US Patent 9,964,407

Cat. No.	Number of Vials	Type of Vials	Overall Length	Weight
935R	3	0°, 90°, 45°	9" (228.6 mm)	0.53 lb (0.24 kg)
9319RETT	3	0°, 90°, 45°	9" (228.6 mm)	0.10 lb (0.05 kg)



935R



9319RETT
SPLIT TETHER RING

Torpedo Level

- Strip magnet bottom holds securely to conduit and metal surfaces
- High-visibility orange level won't get lost on conduit
- Large high-visibility vials are easy to read
- Top V-groove fits contour of pipe

Cat. No.	Number of Vials	Type of Vials	Overall Length	Weight
935	3	0°, 90°, 45°	9" (228.6 mm)	0.27 lb (0.12 kg)



935



Levels

24-Inch Bubble Level

- Adjustable vial allows angle transfer between multiple surfaces
- Patented magnet track keeps powerful rare earth magnets in place
- Top V-Groove fits contour of conduit and pipe
- High visibility vials with reinforced housing
- Durable rubberized end caps for increased drop protection
- Vial accuracy is +/- 0.029°
- US Patent 9,964,407



935L

Cat. No.	Number of Vials	Type of Vials	Overall Length	Weight
NEW 935L	3	0°, 90°, Adjustable	24" (609.6 mm)	1.9125 lb (0.87kg)

Tape Measures

Patent Pending
UNCLUTTERED,
EASY-TO-READ
**BOLD LINES
EVERY 1/8"**



**EXTRA-LARGE
BOLD NUMBERS
FOR IMPROVED
READABILITY**

Up to 9-1/2 ft. (3 m)
STAND-OUT

Magnetic end hooks with dual angle attraction attaches to conduit and steel studs to easily read from above or below

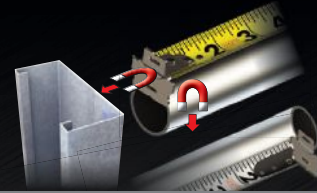

Retraction Speed Brake controls blade speed and protects fingers from having to touch blade



Blade-printed conduit multiplier bending table helps calculate offsets and saddles

Tape Measures

Includes core features plus:

- Heavy duty nylon coating protects blade printing
- Super-sized back clip holds securely to wide belts and extends into pockets
- Printing with centimeters and inches (Cat. Nos. 86315 and 86375)
- Cat. No. 86125 has one-sided printing
- U.S. Patent Pending

Cat. No.	Tape Length	Hook	Magnetic	Overall Width	Overall Length	Weight
86216	16 ft (4.9 m)	Double	Yes	2" (50.8 mm)	3.25" (82.6 mm)	0.81 lb (0.37 kg)
86225	25 ft (7.6 m)	Double	Yes	4.25" (108 mm)	6.5" (165.1 mm)	1.1 lb (0.5 kg)
86125	25 ft (7.6 m)	Single	No	2" (50.8 mm)	3.5" (88.9 mm)	1.1 lb (0.5 kg)
86230	30 ft (9.1 m)	Double	Yes	2" (50.8 mm)	3.75" (95.3 mm)	1.3 lb (0.6 kg)
Metric						
86315	5 m	Double	Yes	2" (50.8 mm)	3.25" (82.6 mm)	0.81 lb (0.37 kg)
86375	7.5 m	Double	Yes	2" (50.8 mm)	3.5" (88.9 mm)	1.1 lb (0.5 kg)



Double Hook End



Single Hook End

⚠ WARNING:

- Protect hands when cleaning magnetic tip end. Use gloves or cloth.
- Avoid magnetic contact with sensitive electronic or computer equipment.
- To avoid personal injury and damage to this tool, do not allow the tape blade to retract into case.
- Do NOT open case. Spring motor is under tension, and opening case may cause injury.



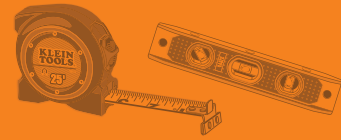

Tape Measures

Tape Measures-Steel with High-Visibility Case

- High-visibility, high-impact orange case makes it easy to find in a tool box, pouch and on the jobsite
- 16" stud markings and 19.2" truss markings



928-25HV

Cat. No.	Tape Length	Hook	Overall Length	Overall Width	Weight
928-25HV	25 ft (7.6 m)	Single	3.5' (88.9 mm)	1" (25.4 mm)	1.0 lb (0.5 kg)

Tape Measure Holders

- Klein offers a complete selection of leather or nylon Tape Holders and Pouches



Tape Measure	Holder Cat. No.	Description	Overall Size	Weight
86216, 86315	5195	Medium Leather Pouch	4-1/2" x 7" (114 mm x 178 mm)	2.9 oz (82 g)
	5707	Nylon Tape Measure Clip/Holder	4-1/8" x 3-3/4" (104 mm x 95 mm)	1.6 oz (45 g)
86125, 86225, 86375	5196	Large Leather Pouch	5" x 7" (127 mm x 178 mm)	3.4 oz (95 g)
	5707	Nylon Tape Measure Clip/Holder	4-1/8" x 3-3/4" (104 mm x 95 mm)	1.6 oz (45 g)
	5195TT	Tape Measure Holder with Tether Ring	3" x 3-1/2" (76 mm x 89 mm)	1.6 oz (45 g)
86230	5196	Large Leather Pouch	5" x 7" (127 mm x 178 mm)	3.4 oz (95 g)
	5707	Nylon Tape Measure Clip/Holder	4-1/8" x 3-3/4" (104 mm x 95 mm)	1.6 oz (45 g)
	5712	Nylon Tape Measure Pouch	3" x 3-1/2" (76 mm x 89 mm)	3.8 oz (109 g)

Laser Measuring

Laser Distance Mesurer

- Meter provides measurements up to 65 ft. (19.8 m) in distance, at an accuracy of + or - 1/16" (1.6 mm)
- Quickly calculates length, area, volume, and pythagoras measurements with large, easy-to-read buttons
- Offers the option of one-touch, single-distance measurement and continuous measurement
- Depth gauge stick flips out to measure from inside corners or channels
- Highly visible backlit display
- Provides both fractional (imperial) and metric readings
- Memory stores last 20 measurements
- Includes batteries and carrying pouch to keep safe when not in use

Cat. No.	Batteries	Overall Length	Overall Height	Overall Width	Weight
93LDM65	2 x AAA	1.375" (34.9 mm)	4.5" (114.3 mm)	2" (50.8 mm)	0.32 lb (0.15 kg)



93LDM65

See page 297 for additional information on warnings.



Folding Rulers

Wood Folding Rules

- Strong, 6' (183 cm) long hardwood rules with clear abrasion-resistant coating
- Black markings on yellow, with red stud center markings every 16 inches
- Measurements are marked on both sides and both edges, graduated to 1/16th inch
- Riveted lock joints are designed for long wear and maintained accuracy
- Extension slide moves under friction in a T-slot with stops at each end. (Cat. No. 905-6)

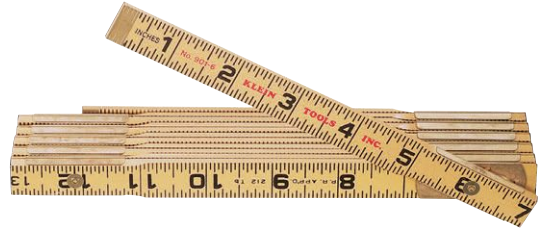

901-6

Cat. No.	Reading	Overall Length	Weight
900-6	Inside	6 ft (1.8 m)	0.33 lb (0.15 kg)
901-6	Outside	6 ft (1.8 m)	0.33 lb (0.15 kg)
905-6	Outside	6 ft (1.8 m)	0.33 lb (0.15 kg)

Non-Conductive Fiberglass Folding Rules

- Constructed of tough nylon, reinforced with glass fibers for added durability, and resistance to weather, abrasion and most chemicals
- Positive locking joints and stainless steel spring hinges for added strength
- Measurements are marked on both sides and both edges, graduated to 1/16th inch
- Black markings on yellow, with red stud center markings every 16 inches
- Engraved graduations on both sides

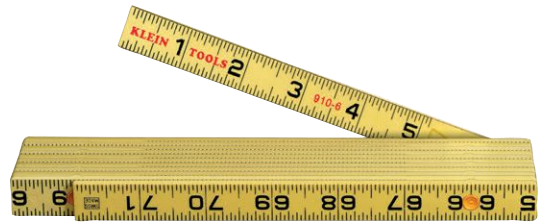

910-6

Cat. No.	Reading	Overall Length	Weight
910-6	Inside	6 ft (1.8 m)	0.33 lb (0.15 kg)
911-6	Outside	6 ft (1.8 m)	0.33 lb (0.15 kg)

Fiberglass Tapes

Woven Fiberglass Tapes

- Woven fiberglass tape with moisture-proof coating of polyvinyl chloride assures durability and protects against oil or chemicals
- Can be immersed in water without adverse effects
- All metal parts are nickel-plated for protection against rust
- Tape line is graduated in feet and inches to 8ths



946-100

946-150

Cat. No.	Tape Length	Hook	Overall Length	Overall Width	Weight
946-50	50 ft (15.2 m)	Single	7.75" (196.9 mm)	1" (25.4 mm)	0.80 lb (0.36 kg)
946-100	100 ft (30 m)	Single	9" (228.6 mm)	1" (25.4 mm)	1.2 lb (0.5 kg)
946-150	150 ft (45.7 m)	Single	13" (330.2 mm)	2" (50.8 mm)	1.7 lb (0.8 kg)





Wire Pulling & Conduit Tools

Pulling wire and working with conduit is very challenging without the proper tools. Klein Tools' complete line of conduit tools allows you to get the job done while saving time, effort and materials.

For Professionals...
Since 1857™

Fish Tapes

Unique sloped handle optimizes hand position for quick hand-over-hand rewinds

Raised fingerrips transfer 100% of the winding power from your hand and fingers

Polypropylene case and handle offer the maximum in impact resistance

Round inner ring design provides a smooth, surface for winding and rewinding



US Patents: 8899554 D574.277; 8.212.178; 8.168.921; 8.164.025
Other patents pending



Available in steel and fiberglass with a wide variety of tips

Multi-Groove Fiberglass Fish Tapes

Includes core fish tape features plus:

- Rigidity for long distance
- Less surface contact when pushing through crowded conduit for smoother tape feeding
- Durable 7" (178 mm) leader helps push through crowded conduit
- Available resin eyelet for total non-conductivity
- Repair kits (Cat. Nos. 56115 and 56025) available to replace tips
- Replacement metal eyelets (Cat. No. 56116) and spiral steel leaders (Cat. No. 56120) available



Old Profile

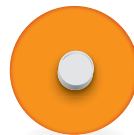

New Profile



Less surface contact with wires



56055

Cat. No.	Tape Size	Diameter	Weight
7" (179 mm) Spiral Steel Leader			
56055	100' x 3/16" (30.5 m x 4.8 mm)	13" (330.2 mm)	3.0 lb (1.4 kg)
56056	200' x 3/16" (61.0 m x 4.8 mm)	17" (431.8 mm)	6.3 lb (2.8 kg)
Non-Conductive Eyelet			
56057	50' x 3/16" (15.2 m x 4.8 mm)	13" (330.2 mm)	2.3 lb (1.1 kg)
56058	100' x 3/16" (30.5 m x 4.8 mm)	13" (330.2 mm)	3.1 lb (1.4 kg)
56059	200' x 3/16" (61.0 m x 4.8 mm)	17" (431.8 mm)	6.0 lb (2.7 kg)



Fish tape tip with non-conductive eyelet



7" spiral steel leader



Fish Tapes

Fiberglass Fish Tapes

Includes core fish tape features plus:

- Designed for flexibility and easy navigation through conduit runs
- Non-conductive, fiberglass fish tape slides easily over existing wires and through multiple bends
- Durable 7" (178 mm) leader helps push through crowded conduit
- The lightweight and strong fiberglass composite tape resists harsh elements and is strength rated up to 500 pulling pounds
- Repair kit (Cat. No. 56115) available to replace tips
- Replacement metal eyelets (Cat. No. 56116) and spiral steel leaders (Cat. No. 56120) available

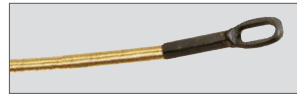

7" spiral steel leader

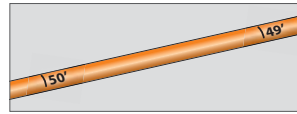

1' permanent laser etched descending increments.



56010

Cat. No.	Tape Size	Diameter	Weight
56009	50' x 3/16" (15.2 m x 4.8 mm)	13" (330.2 mm)	2.8 lb (1.3 kg)
56010	100' x 3/16" (30.5 m x 4.8 mm)	13" (330.2 mm)	3.5 lb (1.6 kg)
56014	200' x 3/16" (60.96 m x 4.8 mm)	17" (431.8 mm)	6.2 lb (2.8 kg)

Steel Fish Tapes

Includes core features plus:

- Stainless Steel fish tape is corrosion resistant extending the life of the tool (Cat. Nos. 56007, 56008)
- High strength spring steel fish tapes are stiff for long runs and are great for heavy-duty wire pulls
- Full grip style handle gives you a firm, steady grip as you pull tape from the case
- Tempered, high quality tape keeps its stability as it glides between surfaces for effective pushing and pulling of wire under carpets, through insulated walls and over suspended ceilings
- 25' length with no snag tip is perfect for short wire runs associated with light commercial, residential and voice-data-video-audio installations (Cat. No. 56005)

Cat. No.	Tape Size	Diameter	Weight
1/8" Wide Steel Fish Tapes			
56007	125' x 1/8" x 0.062" (38.1 m x 3.2 mm x 1.57 mm)	13" (330.2 mm)	4.7 lb (2.1 kg)
56008	240' x 1/8" x 0.062" (73.2 m x 3.2 mm x 1.57 mm)	13" (330.2 mm)	7.5 lb (3.4 kg)
56000	25' x 1/8" x 0.045" (7.6 m x 3.2 mm x 1.14 mm)	7" (177.8 mm)	1.0 lb (0.5 kg)
56001	50' x 1/8" x 0.045" (15.2 m x 3.2 mm x 1.14 mm)	7" (177.8 mm)	1.3 lb (0.6 kg)
56002	65' x 1/8" x 0.062" (19.8 m x 3.2 mm x 1.57 mm)	9" (228.6 mm)	2.6 lb (1.2 kg)
56003	125' x 1/8" x 0.062" (38.1 m x 3.2 mm x 1.57 mm)	13" (330.2 mm)	4.7 lb (2.1 kg)
56004	240' x 1/8" x 0.062" (73.2 m x 3.2 mm x 1.57 mm)	13" (330.2 mm)	7.5 lb (3.4 kg)
1/4" Wide Steel Fish Tapes			
56005	25' x 1/4" x 0.030" (7.6 m x 6.4 mm x 0.76mm)	7" (177.8 mm)	1.1 lb (0.5 kg)
56006	100' x 1/4" x 0.062" (30.5 m x 6.4 mm x 1.57 mm)	13" (330.2 mm)	6.8 lb (3.1 kg)



56001

Tip side profile



No snag plastic tip (Cat. No. 56005)



1' permanent laser etched descending increments.



Spiral Steel Fish Tapes

Includes core fish tape features plus:

- Designed for super flexibility and easy navigation through conduit runs
- Slides easily over existing wires and through multiple bends
- The durable spiral steel tape construction yields a maximum pulling force of up to 250 lbs.
- Replacement metal eyelets (Cat. No. 56116) and spiral steel leaders (Cat. No. 56120) available



7" spiral steel leader



56013

Cat. No.	Tape Size	Diameter	Weight
56013	50' x 3/16" (15.2 m x 4.8 mm)	13" (330.2 mm)	5.1 lb (2.3 kg)

See page 297 for additional information on warnings.



WARNING: Never remove screws while fish tape is coiled inside reel.

Fish Tape Accessories and Replacement Parts

Fiberglass Fish Tape Repair Kit

- Contains high leverage ratcheting crimper, two replacement eyelets, two 7" (179 mm) spiral steel replacement leaders, one tube of quick dry glue and comprehensive instructions
- Multi-function ratcheting crimper (Cat. No. 56115V) cuts tape cleanly, strips tapes and crimps on new attachments
- Newly crimped on eyelets meet or exceed original factory pulling strength requirements
- Protective carry case firmly holds all tools and additional parts in handy, organized compartments
- Cat. No. 56025 is for repairing non-conductive fiberglass fish tapes



Cat. No.	Included	Weight
56115	(1) High Leverage Crimper, (2) 7" (177.8 mm) Flexible Leaders, (2) Eyelets, (1) Tube Quick-Drying Glue	2.2 lb (1.0 kg)
56025	Non-Conductive Eyelets (2 Ea.), Tube Quick-Drying Glue (1 Ea)	2.2 lb (1.0 kg)

2-Pack, 7" Spiral Steel Replacement Flexible Leaders, and 6-Pack, Replacement Eyelets

- For use with all fiberglass fish tapes
- Non-conductive resin eyelets (Cat. No. 56116)
- Attach with Klein Tools ratcheting crimper (Cat. No. 56115V) available in kit 56115 only

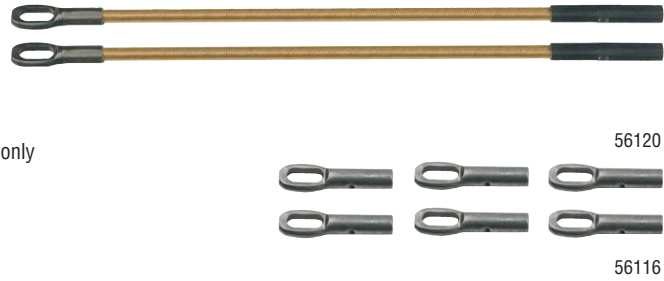

Cat. No.	Diameter	Overall Length	Weight
56120	3/16" (4.8 mm)	8.938" (227 mm)	0.11 lb (0.05 kg)
56116	3/16" (4.8 mm)	1.5" (38.1 mm)	1.0 oz (27 g)

Steel Fish Tape Swivel Eyelet

- For use with 1/8" (6 mm) wide steel fish tapes
- Swivel head design helps prevent kinks and allows smoother, easier fishing in tight turns
- High capacity eyelet holds up to five #12 unstripped wires or seven #10 bare wires
- High strength steel construction allows for optimal performance over repeated uses
- Retrofit instructions included



Cat. No.	Diameter	Overall Length	Weight
50351	3/16" (4.8 mm)	1.5" (38.1 mm)	0.5 oz (14 g)

13" (330 mm) Flexible Spiral Steel Leader for Steel Fish Tapes

- For use with 1/8" (3 mm) wide steel fish tapes
- Heavy duty construction is strength rated up to 250 pulling pounds
- High capacity eyelet holds up to five #12 unstripped wires and seven #10 bare wires
- Retrofit instructions included
- The 3/16" (5 mm) diameter tape has a rustproof inner steel cable core wrapped with a spiral cover for exceptional flexibility
- Flexible leader guides steel tapes through 90° bends and makes pulling and pushing flat steel tapes easier



Cat. No.	Diameter	Overall Length	Weight
50350	3/16" (4.8 mm)	13.5" (342.9 mm)	0.10 lb (0.05 kg)

6 Loop Wire Pulling Leader

- Save time by attaching leader to the end of a fish tape and pull up to six wires at once
- Braided steel construction provides up to 450 lbs. pull strength on main eyelet
- Flexible construction allows for easy navigation through multiple bends in conduit
- Staggered loop lengths won't overlap and clog pipe
- For use with 1/8" and 1/4" (3 mm and 6 mm) flat steel fish tapes



Cat. No.	Overall Length	Weight
56107	11.25" (285.8 mm)	0.20 lb (0.09 kg)



Fish Rods & Accessories



Rods have threaded beveled connectors to attach to desired length and prevent snagging on obstructions

Exclusive Splinter Guard™ protection from painful fiberglass splinters

LO flex – long, straight feeding
HIGH flex – tight bends in walls
MID flex – all needs in between

Luminescent glow rods provide added visibility in dark work spaces

Shines 2X brighter and lasts 2X longer than ordinary glow rods



Splinter Guard™ Fish and Glow Rod Kit

- Kit includes: 8 Splinter Guard™ fish and glow rods, 7 attachments and 1 carrying bag
- 8 Rods: Two (2) 48" long, 1/4" diameter Low-Flex Fish rods, two (2) 18" long and two (2) 60" long 3/16" diameter Mid-Flex Glow rods, two (2) 72" long 5/32" diameter Hi-Flex Glow rods
- 7 Attachments: Whisk, Double-S Hook, Magnet, Chain, Bullet Nose, Single Hook, and Twin Hook (also sold separately, Cat. No. 56511)
- Rods have durable, stainless steel connectors and Splinter Guard™ protective coating to keep hands free of fiberglass splinters
- Rotate the innovative new Double-S Hook to secure wires within its prongs for difficult pulling applications (Patent Pending)
- Attachments fit all Klein Splinter Guard™ fish and glow rods
- Luminescent rods glow in the dark and are rechargeable in most available light
- Adjustable carrying bag is constructed of durable 1680d material with a reinforced bottom and a heavy-duty zipper, accommodates 4-Ft, 5-Ft, and 6-Ft rods and has two exterior zipper pockets for shorter rods, leaders and attachments (also sold separately, Cat. No. 56401)



56400

Cat. No.	Overall Length	Diameter	Included	Weight
NEW 56400	76" (193 cm)	1/4", 3/16", 5/32" (6.4, 4.8, 4.0 mm)	8 Rods, 7 Attachments, 1 Bag	3.2 lb (1.5 kg)

Fish and Glow Rods

- Variety of flexibilities and lengths for any application such as walls, drop ceilings, attics, crawl spaces, etc.
- Sets include bull nose and hook attachments to attach and grab wires
- Cat. No. 56430 also includes illuminated tip



56325

56418

Cat. No.	Description	Diameter	Included	Weight
56312	Lo-Flex Fish Rod Set, 12-Foot	1/4" (6.4 mm)	(3) 4' (1.2 m) Fish Rods with Bullet Nose and Hook Attachments	1.1 lb (0.5 kg)
56324	Lo-Flex Fish Rod Set, 24-Foot	1/4" (6.4 mm)	(4) 6' (1.5 m) Fish Rods with Bullet Nose and Hook Attachments	1.9 lb (0.8 kg)
56325	Fish and Glow Rod Set, 25-Foot	1/4" to 3/16" (6.4 to 4.8 mm)	(5) 4' (1.2 m) Lo-Flex Fish Rods, (1) 5' (1.3 m) Mid-Flex Glow Rod with Bullet Nose and Hook Attachments	1.8 lb (0.8 kg)
56406	Hi-Flex Glow Rod w/Splinter Guard™ Coating, 6-Foot	5/32" (4.0 mm)	(1) 6' (1.8 m) Glow Rod with Bullet Nose	0.20 lb (0.09 kg)
56409	Mid-Flex Glow Rod Set, 9-Foot	3/16" (4.8 mm)	(6) 18' (457.2 mm) Glow Rods with Bullet Nose and Hook Attachments	0.55 lb (0.25 kg)
56415	Mid-Flex Glow Rod Set, 15-Foot	3/16" (4.8 mm)	(3) 5' (1.5 m) Glow Rods with Bullet Nose and Hook Attachments	0.85 lb (0.39 kg)
56418	Hi-Flex Glow Rod Set, 18-Foot	5/32" (4.0 mm)	(3) 6' (1.8 m) Glow Rods with Bullet Nose and Hook Attachments	0.85 lb (0.39 kg)
56430	Glow Rod Set, 30-Foot	3/16" (4.8 mm)	(6) 5' (1.5 m) Glow Rods with Bullet Nose, Hook, and LED-Illuminated Tip Attachments	1.2 lb (0.5 kg)

See page 297 for additional information on warnings.



Fish Rods, Glow Rods & Accessories

SUPER ROD SERIES

Deluxe Fish Rod Set and Mega Fish Rod Set

- Splinter resistant rods in a variety of flexibilities
- Crimped fittings for added strength and functionality
- 3X swivel rods in Mega Set accept twists in cable run
- AXM fittings on the end of each rod are mechanically crimped to carry a load of 550 lbs (250 kg)
- Each set has an extensive range of attachments for all of your wire pulling needs



SRS56980

Cat. No.	Overall Length	Included	Weight
SRS56980	33' (10 m)	10 Rods, 8 Attachments, 1 Carrying Tube	2.1 lb (1.0 kg)
SRS56981	52' (16 m)	13 Rods, 3 Swivel Rods, 12 Attachments, 5 Glow Attachments, 1 Carrying Tube	2.8 lb (1.3 kg)

SUPER ROD SERIES

Polymer Fish Rod Set with Glow-in-the-Dark Leaders

- Non-conductive rods designed for working in confined spaces
- Great for routing cables in wire racks and on short runs
- Attachments glow in the dark for ease of use
- Includes 14" (356 mm) rods of various flexibilities and illumination for a range of individual (or 4' 8" (1.4 m) combined) wire pulling applications
- Includes five Glow-in-the-Dark leaders (hook, bullet, mini-eyelet, domed-eyelet and claw)
- Convenient storage tube protects the rods between use and fits easily into your bag or toolbox

5 Attachments Included



Hook Bullet Mini-Eyelet Domed-Eyelet Claw

SRS56038

Cat. No.	Overall Length	Included	Weight
SRS56038	4' 8" (1.4 m)	(4) Fish Rods, (5) Attachment Heads	0.25 lb (0.11 kg)

Fish Rod Carrying Bag

- Store and protect all your rods and accessories in one place
- Constructed of durable 1680d material with a reinforced base
- Shoulder strap adjusts for easy carrying
- Adjustable bag accommodates 4-Foot, 5-Foot, and 6-Foot rods
- Exterior pockets for 17-Inch rods
- Easily accessible exterior pocket for accessories
- Main compartment with a tough zipper closure



56401

Cat. No.	Overall Length	Overall Height	Overall Width	Weight
NEW 56401	76" (193 cm)	5" (12.7 cm)	3.5" (8.9 cm)	1.0 lb (0.45 kg)

Fish Rod Attachment Set

- Fit all Klein Splinter Guard rods
- 7 attachments: Whisk, Double-S hook, Bullet nose, Twin hook, Single hook, Magnet, Chain
- Innovative new Double-S hook grabs and secures wire and cable in difficult pulling applications (Patent Pending)
- Whisk can be used alone or in conjunction with any of the attachments to guide rods over and past obstacles
- Magnet attaches to the Chain to retrieve wire in blind applications
- Bullet Nose allows easy pulling with the line attachment hole
- Single Hook easily grabs and retrieves wires
- Twin Hook is a grappling-style tool for difficult wire retrieval
- Includes hard plastic carrying case
- Items also sold separately



56511

Cat. No.	Kit Contains	Weight
NEW 56511	Fish Rod Attachment Set, 7-Piece	6 oz (170 g)

Cat. No.	Description
56512	Double-S Hook Fish Rod Attachment
56513	Whisk Replacement Part, Fish Rod Attachment
56514	Chain Replacement Part, Fish Rod Attachment
56515	Magnet Replacement Part, Fish Rod Attachment
56516	Twin Hook Replacement Part, Fish Rod Attachment
56517	Single Hook and Bullet Fish Rod Attachments

Illuminated Fish Rod Tip

- Lights up for maximum visibility in dark spaces
- Bright white, omni-directional LED light for long life
- Threaded top for hook or bullet nose attachment (not included)
- Fits drilled holes as small as 5/8" (16 mm)
- Compatible with LO, MID and HIGH flex rods
- Replaceable batteries included
- U.S. Pat. No. 9,062,834



56119

Cat. No.	Diameter	Overall Length	Weight
56119	37/64" (14.7 mm)	2.5" (63.5 mm)	0.31 lb (0.14 kg)





Wire Pulling Tools

WireSpanner™ - Telescopic Pole 18'

SUPER ROD® SERIES



SRS56036

- Extends to 18' (5.4 m) in 10 seconds
- Easily retrieve cable from a distance without needing an extra pair of hands to shorten installation time
- Large hook attachment pulls multiple wires easily
- Friction-twist lock pole design stays locked in place
- Lightweight resin slides easily over obstructions
- Compact design retracts to 32" (813 mm) for easy storage

Cat. No.	Overall Length	Collapsed Length	Weight
SRS56036	18 ft (5.5 m)	2' 8" (0.8 m)	2.8 lb (1.3 kg)

Magnetic Wire Pulling System

- This system allows you to effortlessly pull cable behind walls by yourself
- Navigates through insulation and other obstructions
- Perfect for routing cable between drywall and insulation or fixture installations
- Swivel leader eyelet securely connects to most wires and mesh wire pulling grips
- Non-marring nylon leader-pull with 20' (6.1 m) of heavy-duty nylon rope eyelet for wire tie-on



SRS56037

Cat. No.	Overall Length	Weight
SRS56037	20 ft (6.1 m)	0.40 lb (0.18 kg)

Wire Pulling Lubricant

Wire Pulling Foam Lubricant

- **NO DRIPS! NO STAINS! NO MESS!**
- One can equals one gallon or 4 quarts of wax/gel lubricants*
- Foam lubricant is applied directly into the conduit. No need to pre-coat wires
- No mess formula stays where it is applied, even in vertical conduit
- Dissolves clean from hands and clothing



51100

Cat. No.	Size	Container	Working Temperature	Weight
51100	19 oz (0.6 L)	Aerosol Can	40° F to 100° F (4° C to 38° C)	1.2 lb (0.5 kg)

* Based on job site pulls with foam in 3/4" conduit when used as directed.



⚠ WARNING:

- Contents under pressure. Do not expose container to direct sunlight or temperatures above 120°F. Do not transport or store near heat sources. Keep cans dry and away from sources of ignition. If frozen, gradually warm to room temperature.
- Do not use wet product on live circuits. Compound is electrically conductive before it dries.

One-Quart Premium Synthetic Clear™

- Designed for use primarily in finished workspaces (for example around painted walls and carpeted floors)
- The crystal clear formulation is easy to clean-up and will not stain
- Excellent all purpose lubricant for electrical or datacom applications
- Compatible with most types of cable jackets
- Will not separate out in hot environments for when exposed to freezing temperatures

Cat. No.	Size	Container	Working Temperature	Weight
51028	1 Quart (0.9 L)	Squeeze Bottle	20° F to 122° F (-6° C to 50° C)	2.3 lb (1.0 kg)

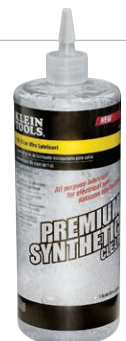

51028

See page 297 for additional information on warnings.



Wire Pulling Lubricant

Premium Synthetic Wax™

- High performance lubricant for general electrical and utility applications
- Temperature stable and does not liquify and drop off after high temperature exposure
- Compatible with most types of cable, including low density polyethylene
- Superior "clingability" coats wires and conduit evenly
- Exceptional lubricity
- Non-staining, slow-drying, easy clean-up formula



Wire Pulling Lubricant 842F

Cat. No.	Size	Container	Working Temperature	Weight
51010	1 Quart (0.9 L)	Squeeze Bottle	20° F to 122° F (-6° C to 50° C)	2.3 lb (1.0 kg)
51012	1 Gallon (3.8 L)	Bucket	20° F to 122° F (-6° C to 50° C)	8.8 lb (4.0 kg)
51013	5 Gallon (18.9 L)	Bucket	20° F to 122° F (-6° C to 50° C)	44.0 lb (20.0 kg)
56117	1 Quart (0.9 L)	Squeeze Bottle - 6 Pack	20° F to 122° F (-6° C to 50° C)	13.5 lb (6.1 kg)



51010



51012

Premium Synthetic Polymer™

- Excellent all-purpose lubricant for electrical, telecommunications and data applications
- Easy-to-apply gel evenly clings instantly to the cable for easy handling and application
- Compatible with most types of cable, including polyethylene and semi conducting jackets
- Superior "clingability" coats wires and conduit evenly
- Non-staining, slow-drying, easy clean-up formula



CERTIFIED TO CSA
STANDARD C22.2 NO. 249-96

Cat. No.	Size	Container	Working Temperature	Weight
51015	1 Quart (0.9 L)	Squeeze Bottle	20° F to 140° F (-6° C to 60° C)	2.3 lb (1.0 kg)
51017	1 Gallon (3.8 L)	Bucket	20° F to 140° F (-6° C to 60° C)	8.8 lb (4.0 kg)
51018	5 Gallon (18.9 L)	Bucket	20° F to 140° F (-6° C to 60° C)	44.0 lb (20.0 kg)



51015



51017

Wire Pulling Supplies

Poly Pull Line

- Use polypropylene line with manual or power fishing systems for light duty cable or rope pulling applications
- Ready to use storage containers quickly dispense a tangle free line and also protects line from direct sunlight
- Line is resistant to rot and mildew
- Up to 210 lbs. (95.2 kg) average breaking strength

Cat. No.	Container	Tensile Strength	Overall Length	Weight
56108	One-Quart Size w/Locking Lid	210 lb (95.2 kg)	500' (152 m)	1.0 lb (0.5 kg)
56110	Five-Gallon Bucket	210 lb (95.2 kg)	6500' (2 km)	11.0 lb (5.0 kg)



56108



56110





Wire Pulling Supplies

Wire Marker Books

- Larger, easy-to-read print
- More pages of the frequently used low numbers (1-24)
- Each page is perforated so that a third, two-thirds or the entire page can be easily detached
- Strong tack for lasting adhesion on oily wires
- Markers are a vinyl coated white cloth, 8 mils thick



Cat. No.	Description	Color	Number of Pages	Overall Length	Overall Width	Weight
56250	Wire Marker Book, 1-48	Black Print on White	14	5.5" (139.7 mm)	3.328" (84.5 mm)	2.1 oz (59 g)
56251	Wire Marker Book 120/240V 3 Phase 1-48	Black, Blue, Red Printed on White	14	5.5" (139.7 mm)	3.328" (84.5 mm)	2.1 oz (59 g)
56252	Wire Marker Book 277/480V 3 Phase 1-48	Brown, Orange, Yellow Print on White	14	5.5" (139.7 mm)	3.328" (84.5 mm)	2.1 oz (59 g)
56253	Wire Marker Book-Black Letters, Numbers and Symbols	Black Print on White	10	5.5" (139.7 mm)	3.328" (84.5 mm)	1.6 oz (45 g)
56254	Wire Marker Book-Household Electrical Panel	Black Print on White	10	5.5" (139.7 mm)	3.328" (84.5 mm)	1.6 oz (45 g)
56255	Wire Markers-Household Electric Panel w/Directory	Black Print on White	10	6.375" (161.9 mm)	3.625" (92.1 mm)	2.1 oz (60 g)



Conduit Benders

Exclusive design reduces rippling and ovaling of conduit

Wide foot pedal provides excellent stability, leverage and comfort

Bold cast-in symbols, degree scales, multiplier scales and center of bend marks help save time on the job

Interior clamp securely holds conduit while cutting with hacksaw

The traditional Benfield® head design accurately and consistently performs common bends such as Stub Ups, Offsets, Back-to-Back and Saddle Bends

Interior hook surface prevents conduit from rolling or twisting during bends

Easily visible arrow for ease of alignment on conduit marks



Aluminum Conduit Benders

Includes core conduit bender features plus:

- Lightweight die-cast aluminum construction
- Both Cat. Nos. 56206 and 56207 come assembled with #51427 handle



Cat. No.	Centerline Bend Radius	Thinwall/EMT	Rigid/IMC	Included	Weight
56206	5" (127.0 mm)	1/2" (12.7 mm)	—	Handle 51427	4.4 lb (2.0 kg)
56207	6" (152.4 mm)	3/4" (19.1 mm)	1/2" (12.7 mm)	Handle 51427	5.4 lb (2.5 kg)



56207

See page 297 for additional information on warnings.



Conduit Benders

Iron Conduit Benders

Includes core conduit bender features plus:

- High strength steel handle features a swaged end for inserting conduit to correct overbends (Cat. Nos. 56203 & 56204 only)
- Bright orange color handle is easy to spot on the jobsite

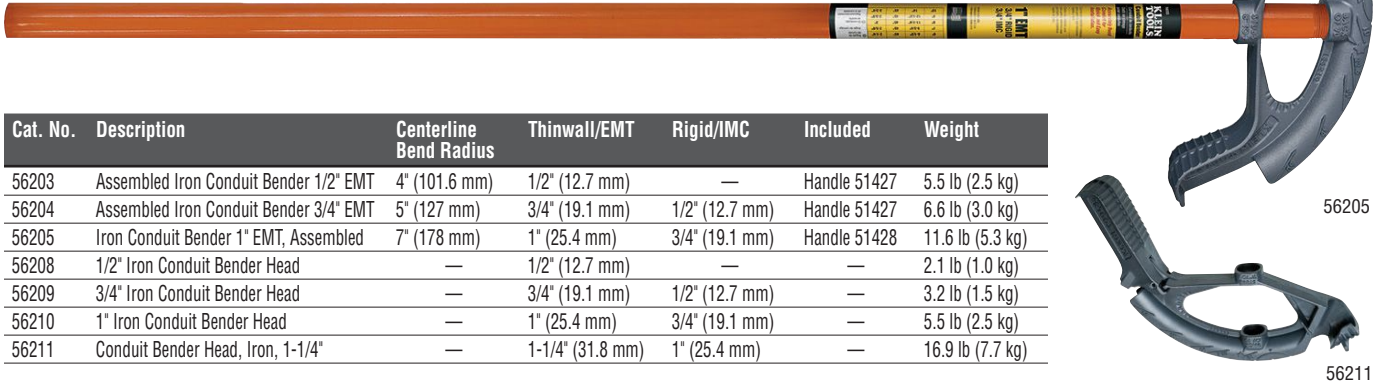

Cat. No.	Description	Centerline Bend Radius	Thinwall/EMT	Rigid/IMC	Included	Weight
56203	Assembled Iron Conduit Bender 1/2" EMT	4" (101.6 mm)	1/2" (12.7 mm)	—	Handle 51427	5.5 lb (2.5 kg)
56204	Assembled Iron Conduit Bender 3/4" EMT	5" (127 mm)	3/4" (19.1 mm)	1/2" (12.7 mm)	Handle 51427	6.6 lb (3.0 kg)
56205	Iron Conduit Bender 1" EMT, Assembled	7" (178 mm)	1" (25.4 mm)	3/4" (19.1 mm)	Handle 51428	11.6 lb (5.3 kg)
56208	1/2" Iron Conduit Bender Head	—	1/2" (12.7 mm)	—	—	2.1 lb (1.0 kg)
56209	3/4" Iron Conduit Bender Head	—	3/4" (19.1 mm)	1/2" (12.7 mm)	—	3.2 lb (1.5 kg)
56210	1" Iron Conduit Bender Head	—	1" (25.4 mm)	3/4" (19.1 mm)	—	5.5 lb (2.5 kg)
56211	Conduit Bender Head, Iron, 1-1/4"	—	1-1/4" (31.8 mm)	1" (25.4 mm)	—	16.9 lb (7.7 kg)



Bender Handles

- Available in multiple sizes and lengths and are compatible with all Klein Tools conduit bender heads
- High-strength steel eliminates flex and provides excellent feel, control and leverage
- Handle features an enlarged diameter hollow end for inserting conduit to correct overbends (Cat. No. 51427)
- Bright orange color is easy to spot on the jobsite



Cat. No.	NPT Tap Size	For Use With	Overall Length	Weight
51427	3/4" (19.1 mm)	1/2" and 3/4" Bender Heads (Cat. No. 56208 and 56209)	38" (965.2 mm)	3.5 lb (1.6 kg)
51428	1" (25.4 mm)	1" Bender Head (Cat. No. 56210)	44" (111.8 cm)	6.0 lb (2.7 kg)
51429	1-1/4" (31.8 mm)	1-1/4" Bender Head (Cat. No. 56211)	54" (137.2 cm)	8.9 lb (4.0 kg)

Conduit Tools

BX and Armored Cable Cutter

- Cuts BX and 3/8" armored cable
- Eliminates burrs
- Does not nick cable
- Easily cuts 3/8" flexible conduit and #10, 12, and 14 armored cables with up to 4 wires with a couple of turns of the handle
- Depth of cut adjusts between standard MC and reduced diameter MC
- Extra blade storage in handle
- Use with Klein Tools replacement blade Cat. No. 53726-SEN



Cat. No.	Handle Color	Cutting Capacity	Overall Length	Weight
53725	Black	3/8" Flexible Conduit, #10, #12, and #14 Armored Cable	7.25" (184.2 mm)	2.0 lb (0.9 kg)





Conduit Tools

Electrician's Conduit Scoring Tool

- Durable zinc cast scoring tool eliminates spiraling
- Used for scoring 1/2", 3/4" and 1" EMT conduit
- Klein-designed, patented scoring wheel scores and allows clean conduit snaps without leaving burrs inside
- 1" scoring wheel conveniently located in base of the handle; no tools required to replace scoring wheels
- Four roller tracks specifically designed for professional use
- Compact, enclosed design for use on job sites



88906



REPLACEMENT BLADES
1/2" & 3/4" — 88907
1" — 88908

US Patent: D638451

Cat. No.	Cutting Capacity	Overall Length	Weight
88906	Scores 1/2", 3/4" and 1" (12.7 mm, 19.1 mm and 25.4 mm) EMT Conduit	6" (152.4 mm)	1.3 lb (0.6 kg)

Conduit Locknut Wrench

- Easily attach locknuts in tight or deep cut-in boxes
- For 1/2" and 3/4" connectors
- Direct-drive heads rotate each other when twisted
- Heavy-duty steel construction enables needed torque to loosen or tighten connectors
- Perfect for remodel work where box is filled with existing wires



56999

US Patent pending

Cat. No.	Size	Overall Length	Weight
56999	1/2" and 3/4"	9" (228.6 mm)	0.70 lb (0.32 kg)



Fish Tape Pulling Pliers

Includes core side-cutting features plus:

- Easily pulls 1/8" or 1/4" flat steel fish tape without damaging the tape
- Crimps non-insulated connectors, lugs, and terminals (Cat. No. J2000-9NECRTP)



D213-9NETP

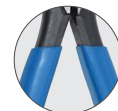

Plastic-Dipped



JOURNEYMAN™
Dual-Material

Cat. No.	Jaw Length	Jaw Width	Jaw Thickness	Knife Length	Handle Color	Handle Finish	Overall Length	Weight
D213-9NETP	1.594" (40.5 mm)	1.25" (31.8 mm)	5/8" (15.9 mm)	0.781" (19.8 mm)	Dark Blue	Plastic-Dipped	9.375" (238.1 mm)	1.1 lb (0.5 kg)
J213-9NETP	1.594" (40.5 mm)	1.25" (31.8 mm)	5/8" (15.9 mm)	0.781" (19.8 mm)	Dark Blue/Black	Journeyman	9.5" (241.3 mm)	1.1 lb (0.5 kg)
Pliers with heavy-duty cutting knives designed to cut ASCR, screws, nails and most hardened wire								
D2000-9NETP	1.594" (40.5 mm)	1.25" (31.8 mm)	5/8" (15.9 mm)	0.781" (19.8 mm)	Light Blue	Plastic-Dipped	9.375" (238.1 mm)	1.1 lb (0.5 kg)
J2000-9NETP	1.594" (40.5 mm)	1.25" (31.8 mm)	5/8" (15.9 mm)	0.781" (19.8 mm)	Light Blue/Black	Journeyman	9.5" (241.3 mm)	1.1 lb (0.5 kg)
J2000-9NECRTP	1.594" (40.5 mm)	1.25" (31.8 mm)	1-19/32" (40.5 mm)	0.781" (19.8 mm)	Blue/Black	Journeyman	9.5" (241.3 mm)	1.1 lb (0.5 kg)

See page 297 for additional information on warnings.



Conduit Tools

Conduit Locknut and Reaming Pliers

- Tightens 1/2" (13 mm) and 3/4" (19 mm) EMT or 1/2" (13 mm) rigid locknuts
- Fits liquid tight fittings and caps
- Reams and deburrs both inside and outside of conduit
- Knurled jaws at nose tip pull wire or fish tape
- Machined nose fits snugly into locknut wings

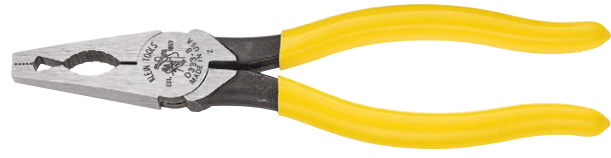

D333-8

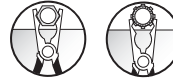

Cat. No.	Jaw Length	Jaw Width	Jaw Thickness	Point Diameter	Handle Color	Handle Finish	Overall Length	Weight
D333-8	1.625" (41.3 mm)	0.938" (23.8 mm)	1/2" (12.7 mm)	3/16" (4.8 mm)	Yellow	Plastic-Dipped	7.75" (196.9 mm)	0.55 lb (0.25 kg)

Conduit-Fitting and Reaming Screwdriver

- Hooded-blade design keeps tip from slipping out of screws, especially when tightening hard-to-reach conduit fittings. Thicker hood is designed for rugged use
- Reams both the inside and outside of the conduit at the same time
- 5/16" (8 mm) screwdriver tip with 2-1/2" (64 mm) long shank
- Longer Cushion-Grip handle provides comfort and more torque for reaming
- Replaceable reaming blade is now held in place with a 1/6" (1.5 mm) set screw



85191

Cat. No.	Conduit Size	Overall Length	Weight
85191	1/2" (12.7 mm), 3/4" (19.1 mm), 1" (25.4 mm)	7.5" (190.5 mm)	0.50 lb (0.23 kg)

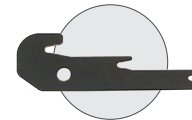

19353
CONDUIT REAMER
REPLACEMENT BLADE, 2pk

Conduit Reamer

- Locks onto screwdrivers; reams and smooths thin-wall conduit
- Reams ID and OD at the same time
- Two set-screws for round- and square-shank screwdrivers
- Fits up to 3/8" (10 mm) keystone-tip screwdrivers
- NOT for use on power tools



19352



19353
CONDUIT REAMER
REPLACEMENT BLADE, 2pk

Cat. No.	Conduit Size	Overall Length	Weight
19352	1/2" (12.7 mm), 3/4" (19.1 mm), 1" (25.4 mm)	6.75" (171.5 mm)	0.20 lb (0.09 kg)

Power Conduit Reamer

IMPACT RATED!

- Ream conduit and install fittings in a fraction of the time
- Designed to fit into power drill chucks and quick release adapters; impact ready
- Replacement blades are available and the only approved blade for use in this tool
- Replacement bits are available but any standard 1/4" hex bit will work

Precision engineered
replaceable reaming blade

1/4" hex
quick connect



85091

4x Stronger
Bit Retention



NOTE: Read and follow safety instructions in power tool owner's manual.

Cat. No.	Conduit Size	Overall Length	Weight
85091	1/2" (12.7 mm), 3/4" (19.1 mm), 1" (25.4 mm)	5.75" (146.1 mm)	0.33 lb (0.15 kg)



19353
CONDUIT REAMER
REPLACEMENT BLADE, 2pk





PVC Cutters

PVC-Cutter

- Cuts up to 3/4" schedule 40 PVC
- Makes clean burr-free cuts in PVC and flexible pipe
- Reversible blade doubles life
- Cuts 1-3/8" outer diameter flexible plastic pipe
- Steel construction for strength
- Guide helps cut pipe squarely
- Handle latch keeps tool closed

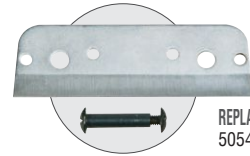

50506-SEN

REPLACEMENT BLADES
50549

Cat. No.	PVC Cutting Capacity	Non-metallic Tubing Cutting Capacity	Overall Length	Weight
50506SEN	Up to 3/4" (19.1 mm) Schedule 40	1" (25.4 mm) Non-Metallic Tubing Cutting, 1-3/8" (34.9 mm) Flexible Pipe Cutting	8.5" (215.9 mm)	1.0 lb (0.5 kg)

Ratcheting PVC-Cutters

- Provide straight cuts 1/2"-2" I.D. (13 mm-51 mm) O.D. 5/8" - 2-1/2" (16 mm-64 mm) of white and gray schedule 40 and 80 PVC
- Quick, one-handed blade release
- Ratchet action allows easy, one-hand cutting
- No tools required for instant blade change
- Replacement blade and pin available



50031



REPLACEMENT BLADE FOR 50034
50035



REPLACEMENT BLADE FOR 50031
50035



REPLACEMENT RETAINING PIN
50033

Cat. No.	PVC Cutting Capacity	Non-metallic Tubing Cutting Capacity	Overall Length	Weight
50031	O.D. 5/8" to 1-5/8" (15.9 to 41.3 mm); I.D. 1/2" to 1-1/4" (12.7 to 31.8 mm)	—	9" (228.6 mm)	1.1 lb (0.5 kg)
50034	O.D. 5/8" to 2-1/2" (15.9 to 63.5 mm); I.D. 1/2" to 2" (12.7 to 50.8 mm)	—	11" (279.4 mm)	1.3 lb (0.6 kg)

⚠ WARNING: Do NOT cut cold PVC.

⚠ WARNING: Do NOT use to cut metallic pipes, cable or wire.



Personal Protective Equipment and Safety Products

Klein Tools provides personal protective equipment and safety products to help guard against a wide variety of occupational hazards.



For Professionals...
Since 1857™



Protective Eyewear

Impact resistant polycarbonate lenses block greater than 99.9% of harmful UVA and UVB radiation up to 400 nanometers.

Permanently bonded **Uvextreme® anti-fog coating** with anti-scratch, anti-static and UV protection properties.

Adjustable spatulite temples provide a comfortable customized fit.

Temple-end holes for easy lanyard attachment.

Wrap-around lens with integrated side shields provides a clear, unobstructed field of vision and superior coverage.

Meets the traffic signal color recognition requirements of **ANSI Z80.3-1996**.



Lens Color



Uvextreme® and Spectrum Control Technology® (SCT®) are registered trademarks of Sperian Eye & Face Protection, Inc.
*SCT® = Spectrum Control Technology



Protective Eyewear - Standard

- Meets military Vo ballistic test for impact
- Soft elastomer brow-guard absorbs, diffuses and deflects impact energy
- Soft flexible fingers adjust and conform to most nasal profiles reducing slippage
- Three position ratchet lens inclination adjusts for a custom fit and unsurpassed comfort
- Lens designed to follow the contour of the cheekbone and create a “zone of protection”
- Dual 9-base wrap-around lens provides uncompromised peripheral vision
- Unique ventilation channel delivers an outstanding level of moisture and fog control
- Made in USA with global components



60053

Cat. No.	Frame Color	Lens Color	Environment	Light Intensity	True Color Recognition	Visual Light Transmitted	IR Absorption	Blue Light Transmittance	Accidental Arc Protection	Weight
60046	Black	Dark Gray	Outdoor	Normal to Bright	Yes	10%	60%	—	No	2.4 oz (68 g)
60047	Black	SCT Gray	Outdoor	Normal to Bright	Yes	15%	>85%	<7%	Yes	2.4 oz (68 g)
60049	Black	Amber	Indoor/Outdoor	Normal to Low	No	90%	—	—	No	2.4 oz (68 g)
60053	Black	Clear	Indoor	Normal to Low	Yes	92%	—	—	No	2.4 oz (68 g)
60054	Light Blue	Clear	Indoor	Normal to Low	Yes	92%	—	—	No	2.4 oz (68 g)
60055	Black	Espresso	Outdoor	Normal to Bright	Yes	15%	60%	<3%	No	2.4 oz (68 g)

Protective Eyewear - Frameless

- Meets military Vo ballistic test for impact (7x greater than ANSI)
- Secure wrap-around brow expands to fit a wide range of users
- Ultra lightweight design offers ultimate comfort at less than one ounce
- Proprietary Floating Lens offers increased flexibility in fit
- Soft temple tip pads provide a comfortable and secure fit
- Does not have lanyard holes
- Made in USA with global components



60056

Cat. No.	Frame Color	Lens Color	Environment	Light Intensity	True Color Recognition	Visual Light Transmitted	IR Absorption	Blue Light Transmittance	Accidental Arc Protection	Weight
60056	Black	Clear	Indoor	Normal to Low	Yes	92%	—	—	No	2.6 oz (73 g)
60057	Black	Espresso	Outdoor	Normal to Bright	Yes	15%	60%	<3%	No	2.6 oz (73 g)

See page 297 for additional information on warnings.



TRADESMAN PRO™

Personal Protective Equipment

Tradesman Pro™ Shoe Covers

- High quality, durable nylon construction
- Water resistant
- High traction, slip resistant soles (exceeds 0.5 COF per ASTM D1894)
- Reusable; 6-9 month average lifespan with daily use
- Easy on and off
- Machine wash cold, air dry
- Made in USA with global components



55487

Cat. No.	Color	Size	Package Quantity	Weight
55487	Black	Medium: Men's Boot 7-10; Wmn's Boot 8.5-10.5	1 Pair	3.5 oz (100 g)
55488	Black	Large: Men's Boot 10.5-13 or Wmn's Boot 11 and Up	1 Pair	3.5 oz (100 g)
55489	Black	Extra Large: Fits Men's Boot 13.5-17	1 Pair	3.5 oz (100 g)

Tradesman Pro™ Knee Pads

- Five layers of impact resistant material for protection and comfort
- For comfort: an inner fabric layer of neoprene, an over-sized impact-absorbing gel layer, a molded polyurethane foam layer
- For protection: a super-tough 600d outer fabric layer, a protective outer shell with stabilizing non-slip surface
- Single strap doesn't bunch behind your leg
- Quick-fasten buckle
- Knee pads are sold in pairs

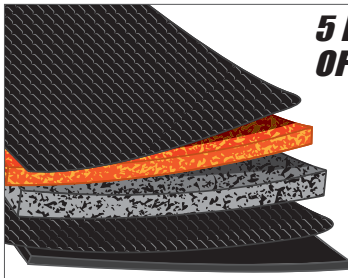

5 LAYERS OF PROTECTION

1. Neoprene inner comfort fabric
2. Oversized impact-absorbing gel
3. Molded polyurethane foam
4. Super tough 600d outer fabric
5. Protective molded outer shell



55629

Cat. No.	Overall Length	Overall Height	Overall Width	Weight
55629	3.5" (88.9 mm)	9.5" (241.3 mm)	7.5" (190.5 mm)	1.2 lb (0.5 kg)

Hard Hats and Accessories

V-Gard® Hats

- Polyethylene shell with 4-point Fas-Trac® ratcheting suspension
- Standard size fits head sizes 6 - 8
- Two branding choices: plain front and Klein Tools Lineman Logo
- Type 1 helmet meets or exceeds ANSI Z89.1-2009 and CSA Z94.1-2005 specifications for Class E
- Third Party Certified by Safety Equipment Institute
- Made in USA

Available in two colors



60031

Cat. No.	Shell Color	Weight
60028	White	0.95 lb (0.43 kg)
60030	Blue	0.95 lb (0.43 kg)
60031	White w/Lineman Logo	0.95 lb (0.43 kg)

V-Gard® and Fas-Trac® are registered trademarks of Mine Safety Appliances Company. All V-Gard® helmet backs contain the Klein logo with American flag (shown on blue hard hat above). Logo color varies depending on shell color.





Hard Hats and Accessories

Hard Caps and Accessories

- High-density polyethylene hard caps meet ANSI Z89.1-2003 specifications for Class E
- Unique nape strap holds hat firmly in place
- Washable, shrink-and stretch-proof straps and bands
- Porous brow pad promotes ventilation for comfort
- Standard size fits head sizes 6 - 8
- Full 6-point ratcheting suspension
- Headband clips help hold goggles in place over eyes or on front of cap
- Rain trough helps keep neck dry
- Slots at sides for attaching Cat. No. 60060 face shield and other protective gear require a universal slot adapter
- Made in USA

Available in three colors

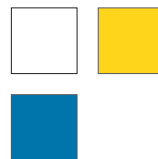

60010

Cat. No.	Shell Color	Weight
60009	White	0.85 lb (0.39 kg)
60010	Yellow	0.85 lb (0.39 kg)
60011	Blue	0.85 lb (0.39 kg)
Winter Hard-Cap Liner		
60015	Blue/Red	2.4 oz (68 g)

Full Face Shield

- Free-floating ratchet head gear with full-tension adjustment and sweat band for added comfort
- High-impact, full-front cap and chin guard for extra protection
- Anti-warp design resists dimensional distortion from heat and moisture
- Big window extends past ears, providing wide-angle protection
- Window is made of clear, tough acetate
- Meets ANSI Z87.1+ 2010 and CSA Z94.3-07 (R2014)
- Made in USA

Cat. No.	Window Dimensions	Weight
60060	19-1/2" W x 6-1/2" H (495.3 mm x 165.1 mm)	1.5 lb (0.7 kg)



60060

Advance® Cap

- Vented style provides cooling vents for improved air circulation and comfort
- Glaregard™ under the brim reduces reflective glare
- Lateral contours above the ear for easy integration of hearing protection
- Polyethylene shell with 4-point Fas-Trac® ratcheting suspension
- Lightweight design for added comfort
- Standard size fits head sizes 6 - 8
- Branding: Plain front with Klein Tools Logo and American Flag on the back of the cap
- Type I helmet meets or exceeds ANSI Z89.1-2003 and specifications for Class C
- Third Party Certified by Safety Equipment Institute
- Made in USA

Available in two colors



60027

Cat. No.	Shell Color	Weight
60025	White	0.84 lb (0.38 kg)
60027	Blue	0.84 lb (0.38 kg)

Glaregard™ is a trademark of, and Advance® is a registered trademark of Mine Safety Appliances Company.

Scope of Z89.1 - 2014 American National Standard for Head Protection

TYPE I (Top Impact) Helmets intended to reduce the force of an impact to the top of a wearer's head.

TYPE II (Top and Lateral Impact) Helmets intended to reduce the force of an impact resulting from a blow received off-center or to the top of a wearer's head.

Electrical Performance

CLASS E (Electrical) Helmets intended to reduce the danger of exposure to high-voltage electrical conductors, proof-tested at 20,000 volts.

CLASS G (General) Helmets intended to reduce the danger of exposure to low-voltage electrical conductors, proof-tested at 2,200 volts.

CLASS C (Conductive) Helmets not intended to provide protection from electrical conductors.

See page 297 for additional information on warnings.



Safety Products

Lockouts with Interlocking Tabs

- Specifically designed for locking out power sources such as disconnects, switches, and panel boxes
- Double interlocking hasp of tempered steel with patented interlocking tabs for extra security
- Hasps are bright zinc-plated
- Riveted construction
- Six-hole locking bodies coated with red vinyl plastic
- Holes will accept up to 5/16" (8 mm) diameter shackles



45201

Cat. No.	Closed Hasp I.D.	Weight
45200	1" (25.4 mm)	3.2 oz (91 g)
45201	1-1/2" (38.1 mm)	4.0 oz (113 g)

WARNING: Use only in accordance with OSHA requirements.

Barricade and Warning Tapes

- Bold, black lettering on bright, long-lasting color backgrounds
- Yellow background for CAUTION/CAUTION tape
- Red background for CAUTION - BURIED ELECTRIC LINE Tape
- Made of tough, durable (2.5 mil) polyethylene
- Highly resistant to acids, alkalis, and other soil components
- Tapes are 3" (76 mm) wide, and are available in either 200' (61 m) or 1000' (305 m) rolls
- Made in USA



58000

Cat. No.	Legend	Color	Overall Length	Overall Width	Weight
58000	CAUTION	Black on Bright Yellow	200 ft (61.0 m)	3" (76.2 mm)	0.90 lb (0.41 kg)
58001	CAUTION	Black on Bright Yellow	1000 ft (305 m)	3" (76.2 mm)	3.6 lb (1.6 kg)
58002	CAUTION-BURIED ELECTRIC LINE	Black on Bright Red	200 ft (61.0 m)	3" (76.2 mm)	0.80 lb (0.36 kg)
58003	CAUTION-BURIED ELECTRIC LINE	Black on Bright Red	1000 ft (305 m)	3" (76.2 mm)	3.5 lb (1.6 kg)

Cleaners

Klein Kleeners™ Hand Cleaning Towels

- Simple and convenient
- Pre-moistened towels
- No rinsing - no drying - no residue
- Powerful, yet gentle, pumice-like cleaning action
- Quickly loosens, dissolves, and absorbs dirt and grease
- Features a natural citrus solvent that's gentler than petroleum-based hand cleaners
- Made in USA



51425

Cat. No.	Towel Size	Package Quantity	Weight
51425	9" x 12" (228.6 mm x 304.8 mm)	72	2.5 lb (1.1 kg)

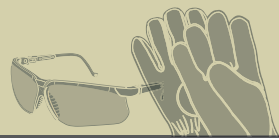

Gloves

JOURNEYMAN™

Wire Pulling Gloves

- Great gripping ability
- Slim fit for better dexterity
- Touchscreen capability on index finger
- Neoprene wrist closure for comfort

Cat. No.	Size	Weight
40232	Medium	3.2 oz (91 g)
40233	Large	3.7 oz (104 g)
40234	Extra Large	3.7 oz (104 g)



40233

High Dexterity Touchscreen Gloves

- Touchscreen capability on entire palm, all fingers, first knuckles
- Slim fit for extra dexterity
- Comfortable glove for light duty tasks

Cat. No.	Size	Weight
40229	Medium	1.6 oz (45 g)
40230	Large	1.6 oz (45 g)
40231	Extra Large	1.6 oz (45 g)



40230

Leather Utility Gloves

- Durable and comfortable
- Open cuff for quick on/off
- DuraHide™ palm and leather first fingers for durability
- Stretch back for extra comfort and flexibility

Cat. No.	Size	Weight
40226	Medium	1.6 oz (45 g)
40227	Large	1.6 oz (45 g)
40228	Extra Large	1.6 oz (45 g)

DuraHide™ is a trademark of Mechanix Wear, Inc.



40227

See page 297 for additional information on warnings.

⚠ WARNING: Not flameproof or fire retardant. DO NOT expose to open flame or sparks.

JOURNEYMAN

Gloves

Utility Gloves

- Moisture wicking and breathable TrekDry™ stretch material on top with sponge foam and tricot lining for maximum comfort
- Durable synthetic leather palm
- Reinforced thumb and finger panels add protection and durability
- Wide opening elastic cuff for easy entry

Cat. No.	Size	Weight
40205	Medium	2.1 oz (59 g)
40206	Large	2.1 oz (59 g)
40207	Extra-Large	2.1 oz (59 g)

TrekDry™ is a trademark of Mechanix Wear, Inc.



40206

Camouflage Gloves

- Mossy Oak® Break-Up Infinity™ pattern
- Moisture wicking and breathable TrekDry™ stretch material on top with sponge foam and tricot lining for maximum comfort
- Reinforced thumb and finger panels add protection and durability
- Single layer, seamless palm made of durable synthetic leather for improved fit and dexterity
- Soft molded rubber closure with hook and loop secures fit

Cat. No.	Size	Weight
40208	Medium	2.7 oz (77 g)
40209	Large	2.7 oz (77 g)
40210	Extra-Large	2.7 oz (77 g)

Trek Dry™ is a trademark of Mechanix Wear, Inc.; Mossy Oak® is registered trademark of Haas Outdoors Inc.



40209

“Cold Weather Pro” Gloves

- Palm and fingers lined with Thinsulate™ C40 with fingertip designed for improved dexterity
- Water resistant nylon back lined with Thinsulate™ C100
- Durable rubberized palm provides water resistance and grip with 2mm EVA foam padding for impact protection
- 5 mm EVA foam knuckle for impact protection and comfort
- Neoprene thumb and cuff for comfort and water resistance
- Molded rubber closure with hook and loop secures fit

Cat. No.	Size	Weight
40211	Medium	4.6 oz (132 g)
40212	Large	4.6 oz (132 g)
40213	Extra-Large	4.6 oz (132 g)

Thinsulate™ is trademark of 3M.



40212



Gloves

JOURNEYMAN™

“Grip” Gloves

- Armortex® rubberized grip on the fingers with reinforced synthetic leather palms and thumb for ample grip in both wet and dry conditions
- D30® padding material in the palm to absorb impact and vibration
- Moisture wicking and breathable TrekDry™ stretch material on top with sponge foam and tricot lining for maximum comfort
- Machine washable
- Flexible yet impact absorbing thermo plastic rubber (TPR) protects the fingers and back of the hand
- Neoprene cuff and soft molded rubber closure with hook and loop secures fit

Cat. No.	Size	Weight
40214	Medium	4.6 oz (132 g)
40215	Large	4.6 oz (132 g)
40216	Extra-Large	4.6 oz (132 g)

Trek Dry™ is a trademark of Mechanix Wear, Inc.; D30® is a registered trademark of Design Blue Limited; Armortex® is a registered trademark of Nam Liong Enterprise Co. Ltd.



40215

“Extreme” Gloves

- Flexible yet impact absorbing thermo plastic rubber (TPR) and EVA foam protects the fingers, knuckles and back of the hand
- D30® padding material in the palm to absorb impact and vibration
- Palm and thumb reinforced with synthetic leather for extra durability
- Breathable two-way stretch materials on top with sponge foam and tricot lining for maximum comfort
- Rubberized fingertips for extra grip
- Wrist closure with hook and loop secures fit

Cat. No.	Size	Weight
40217	Medium	5.4 oz (154 g)
40218	Large	5.4 oz (154 g)
40219	Extra-Large	5.4 oz (154 g)

D30® is a registered trademark of Design Blue Limited.



40218

Leather Gloves

- Genuine professional grade leather offers the finest in protection and comfort
- Flexible yet impact absorbing thermo plastic rubber (TPR) protects the fingers and back of the hand
- Reinforced palm with 2mm EVA foam padding for impact protection
- Moisture wicking and breathable TrekDry™ stretch material on top with sponge foam and tricot lining for maximum comfort
- Machine wash and dry
- Neoprene cuff and soft molded rubber closure with hook and loop secures fit

Cat. No.	Size	Weight
40220	Medium	4.8 oz (136 g)
40221	Large	4.8 oz (136 g)
40222	Extra-Large	4.8 oz (136 g)

Trek Dry™ is a trademark of Mechanix Wear, Inc.



40220

See page 297 for additional information on warnings.

⚠ WARNING: Not flameproof or fire retardant. DO NOT expose to open flame or sparks.

Gloves

Cowhide Work Gloves

- Premium cowhide, soft and form-fitting for maximum comfort
- Gunn cut with seams away from wear surfaces
- Inseam index finger
- Shirred-elastic wrist back
- Natural light-tan color

Cat. No.	Size	Weight
40021	Medium	3.5 oz (100 g)
40022	Large	3.7 oz (104 g)
40023	Extra-Large	3.8 oz (109 g)
Lined – Pile Lining		
40016	Medium	5.8 oz (163 g)
40017	Large	6.1 oz (172 g)
40018	Extra-Large	6.6 oz (186 g)



40022

Cowhide Driver's Gloves

- Tough, durable, sueded cowhide leather
- Easy-action thumb - unique design allows leather to conform to your thumb and hand (Cat. Nos. 40003, 40004, 40006, 40007)
- Gunn cut with seams away from wear surfaces
- Lap-seam index finger and shirred-elastic wrist back
- Gray color

Cat. No.	Size	Weight
40003	Small	4.8 oz (136 g)
40004	Medium	6.4 oz (181 g)
40006	Large	6.9 oz (195 g)
40007	Extra Large	4.8 oz (136 g)
Thermolite® Lining		
40014	Large	7.5 oz (213 g)
40015	Extra-Large	8.2 oz (231 g)



40014

Medium and Long-Cuff Gloves

- Heavy sueded leather (Cat No. 40008)
- Soft, flexible, top-grain cowhide leather (Cat. Nos. 40010 and 40012)
- Leather fingers, palm, pull, and knuckle strap (Cat. Nos. 40010 and 40012)
- Gunn cut with seams away from wear surfaces
- Wing thumb, seamless index finger, elastic wrist-back strap
- Lined palm and fingers
- Rubberized, waterproof, bell gauntlet cuff 5" (127 mm) long (Cat. Nos. 40010 and 40012)

Cat. No.	Size	Weight
40008	Large	7.7 oz (218 g)
40010	Large	9.4 oz (268 g)
40012	Extra-Large	10.9 oz (308 g)



40008

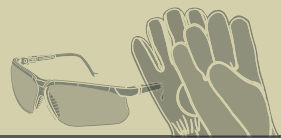

Gloves

Lineman Work Gloves

- 4" Neoprene cuff with side vents
- Soft grain leather construction with reinforced leather patches
- Double-row padded knuckle for durability
- Black spandex back with Klein lineman logo patch

Cat. No.	Size	Weight
40080	Medium	7.4 oz (209 g)
40082	Large	8.2 oz (231 g)
40084	Extra-Large	8.8 oz (249 g)
40086	Extra Extra-Large	9.4 oz (268 g)



40080

Electrician's Gloves

- Durable construction allows flexibility
- Features slip resistant construction
- Spandex material is breathable and comfortable to wear all day
- Constructed with a reinforced area at the base of the thumb
- Elastic cuff for secure and comfortable fit
- Index fingers are wrapped with slip-resistant material
- Extended cuff for easy on/off

Cat. No.	Size	Weight
40072	Large	7.4 oz (209 g)
40074	Extra-Large	7.7 oz (218 g)



40072

Heavyweight Jersey Gloves

- Soft, comfortable, general-purpose gloves
- Made of 100% cotton jersey
- Knit wrist
- Dark-brown color

Cat. No.	Size	Weight
40002	Fits Most Hand Sizes	2.4 oz (68 g)



40002

See page 297 for additional information on warnings.

WARNING: Not flameproof or fire retardant. DO NOT expose to open flame or sparks.

Jobsite Accessories

We understand the heavy demands of the professional on the jobsite. Klein has developed accessories with the strength to match the jobsite demands and make the professional's day less stressful.



For Professionals...
Since 1857™



Coolers

TRADESMAN PRO™

Tough Box Coolers

- Keeps cool up to 30 hours!
- Cat. No. 55600 main compartment has a 17 qt. (16.1 L), 18 can capacity; Cat. No. 55625 main compartment has a 9 qt. (8.5 L) or 11 can capacity
- Industrial exterior body design supports seating capacity of up to 300 lb (136 kg)
- No rust, stainless steel hinged lid stays open at 90° to allow uninterrupted access; 17 qt. cooler lid is recessed to accommodate 1 L water bottles
- Lid opens a full 180° to access interior compartment inside the lid to hold items like medicine, keys, napkins, utensils, etc.
- Shoulder strap holds lid in place while carrying and easily converts to a handle (Cat. No. 55600)
- Lock hasp fits #1 Master Lock® or equivalent (not included)
- Cat. No. 55600 Patent Pending Design

KEEPS COOL UP TO **30** HOURS | SUPPORTS UP TO **300** lbs



Cat. No.	Capacity	Number of Compartments	Overall Length	Overall Height	Overall Width	Weight
55600	17 qt (16.1 L)	2	12" (305 mm)	12" (304.8 mm)	16.203" (412 mm)	6.8 lb (3.1 kg)
NEW 55625	9 qt (8.5 L)	2	14.7" (373.4 mm)	12" (304.8 mm)	8.8" (223.5 mm)	4.8 lb (2.2 kg)

Master Lock® is a trademark of Master Lock Company

TRADESMAN PRO™ Coolers

Soft Lunch Cooler

- Stays cool for up to 12 hours
- Double-thick, leak-resistant anti-microbial liner
- 1680d ballistic weave for durability
- Fully-molded bottom protects against the elements
- Separate upper "doghouse" compartment keeps certain items from getting crushed
- Mesh side pockets for extra items
- Front zipper pocket holds keys, napkins, medicine, etc.
- Shoulder strap and handle for easy carrying

KEEPS COOL UP TO **12 HOURS** | **DOUBLE-THICK LINER**



Cat. No.	Overall Length	Overall Height	Overall Width	Number of Compartments	Weight
55601	9.5" (241.3 mm)	13" (330.2 mm)	12" (304.8 mm)	4	3.4 lb (1.5 kg)

55601

Entertainment

Wireless Jobsite Speaker

- Connects wirelessly or a wired auxiliary input
- 32-7/8 ft. (10 m) connectivity range (in open space)
- 10-Hour battery life
- Drop protected up to 6-1/2 ft. (2 m)
- Powerful rear magnet holds speaker to metal surfaces (panels, ducts, etc.)
- Twist-lock flange mounts to Klein's Lighted Tool Bag (Cat. No. 55431)
- 1/4-20 threaded mount on bottom allows attachment to any standard tripod
- Rated IP45 waterproof/dustproof
- Able to answer calls hands-free with the built-in speakerphone
- Includes 1/8" (3.5 mm) stereo auxiliary cable and micro USB-to-standard USB charging cable



AEPJS1

Cat. No.	Overall Length	Overall Height	Overall Width	Weight
AEPJS1	3.875" (98.4 mm)	3.5" (88.9 mm)	2.125" (54 mm)	10 oz (283 g)



Tool Accessories

Magnetic Wristband

- Strong rare earth magnets keep small parts close at hand
- Breathable mesh interior for comfort
- Made of durable 1680d ballistic material
- Fits most wrist sizes
- Securable adjustable hook and loop closure
- Contoured for a comfortable fit around the wrist
- Wrap around your wrist, belt, or tool bag and keep small parts easily within reach



55895

Cat. No.	Overall Length	Overall Width	Weight
NEW 55895	13.25" (336.6 mm)	0.75" (19.1 mm)	4 oz (113.4 g)

Magnetizer / Demagnetizer

- Magnetizes and demagnetizes screwdriver tips and bits using powerful rare earth magnets
- Single swipe operation provides immediate magnetization/demagnetization
- Fits most screwdrivers including precision screwdrivers, 1/4 Slotted, #2 Phillips and #3 Phillips
- Attaches to tool bags or backpacks with the included stainless steel key ring
- US patent pending
- No batteries required
- Made in USA with global materials



MAG2



Cat. No.	Overall Length	Overall Height	Overall Width	Weight
MAG2	2.203" (56 mm)	0.703" (17.9 mm)	1.094" (27.8 mm)	1.1 oz (32 g)

Mobile Phone Holders

- Fits iPhone® and Samsung® and equivalent sized phones as listed
- XX-Large holder Cat. No. 55474 easily accommodates your phone inside its protective case
- Metal clip for attaching to belts up to 2" wide
- Magnetic flap closure
- Constructed of 1680d ballistic weave



55563



55474



55460



Realtree AP-XTRA Camouflage Design
© 2012 of Jordan Outdoor Enterprises, Ltd., all rights reserved.

Cat. No.	Size	Fits iPhone® or Equivalent Size	Fits Samsung® or Equivalent Size	Overall Length	Overall Width	Overall Height	Weight
55460	Small	4, 5		1.5" (38.1 mm)	3" (76.2 mm)	5.75" (146.1 mm)	0.22 lb (0.10 kg)
55461	Large	6, 7, 7s, 8, X	Galaxy® S3, S4, S7	1.5" (38.1 mm)	3.3" (83.7 mm)	6" (152.4 mm)	0.26 lb (0.12 kg)
55468	X-Large	6 Plus, 7 Plus	Galaxy Note® Edge, Note® 7	1.5" (38.1 mm)	3.75" (95.3 mm)	6.75" (171.5 mm)	0.30 lb (0.14 kg)
NEW 55474	XX-Large	6 Plus, 7 Plus, 8 Plus	Galaxy® S7, S8, S8 Plus, S9, S9 Plus, Note® 7, Note® 8, Note® Edge	1.5" (38.1 mm)	3.86" (98.4 mm)	7.13" (182.9 mm)	0.37 lb (0.17 kg)
55563	Large	6, 7, 7s, 8, X	Galaxy® S3, S4, S7	1.5" (38.1 mm)	3.3" (83.7 mm)	6" (152.4 mm)	0.26 lb (0.12 kg)
55564	X-Large	6 Plus, 7 Plus	Galaxy Note® Edge, Note® 7	1.5" (38.1 mm)	3.75" (95.3 mm)	6.75" (171.5 mm)	0.30 lb (0.14 kg)

iPhone® is a registered trademark of Apple, Inc., Galaxy S® is a registered trademark of Samsung Electronics Co., Ltd., Realtree AP-XTRA Camouflage Design © 2012 of Jordan Outdoor Enterprises, Ltd., all rights reserved.

Tool Pouches, Carriers, Belts and Suspenders

Just as Klein offers a variety of tools designed for specific needs, Klein offers a variety of tool pouches, carriers, belts, and suspenders that suit virtually every preference and need.



For Professionals...
Since 1857™



Tool Pouches

Multi-Pocket Tool Pouches

- Stitched and riveted to assure long life
- Made in the USA with global components



Cat. No.	Number of Pockets	Special Features	Material	Belt Connection	Belt Width	Overall Length	Overall Width	Overall Height	Weight
5167	11	Knife Snap, Chain Tape Thong, Metal Tape Measure Holder	Leather	Slotted	2.75" (69.9 mm)	10" (254.0 mm)	2.75" (69.9 mm)	10.5" (266.7 mm)	1.4 lb (0.7 kg)
5165	10	Knife Snap	Leather	Slotted	2" (50.8 mm)	10" (254.0 mm)	2" (50.8 mm)	10" (254.0 mm)	1.3 lb (0.6 kg)
5190	10	Leather Tape Thong	Leather	Slotted	1.75" (44.5 mm)	6" (152.4 mm)	1.75" (44.5 mm)	8.75" (222.3 mm)	0.75 lb (0.34 kg)
5164	8	Knife Snap	Leather	Slotted	2" (50.8 mm)	6.75" (171.5 mm)	2" (50.8 mm)	9.75" (247.7 mm)	1.2 lb (0.5 kg)
5164T	8	Knife Snap	Leather	Tunnel	2.5" (63.5 mm)	6.75" (171.5 mm)	2.5" (63.5 mm)	9.75" (247.7 mm)	1.2 lb (0.6 kg)
5178	8	Knife Snap, Chain Tape Thong, Metal Tape Measure Holder	Leather	Tunnel	2.5" (63.5 mm)	11" (279.4 mm)	2" (50.8 mm)	10" (254.0 mm)	1.0 lb (0.5 kg)
5162T	8	Knife Snap, Leather Tape Thong	Leather	Tunnel	3" (76.2 mm)	8.5" (215.9 mm)	3" (76.2 mm)	10.75" (273.1 mm)	1.7 lb (0.8 kg)
5166	7	Chain Tape Thong	Leather	Tunnel	2.25" (57.2 mm)	7" (177.8 mm)	2.25" (57.2 mm)	9.5" (241.3 mm)	0.92 lb (0.42 kg)

Tool Pouches

Multi-Pocket Tool Pouches

- Stitched and riveted to assure long life
- Made in the USA with global components

6-Pocket



5-Pocket



4-Pocket



3-Pocket



Cat. No.	Number of Pockets	Special Features	Material	Belt Connection	Belt Width	Overall Length	Overall Width	Overall Height	Weight
5127	6	Knife Snap	Leather	Slotted	2" (50.8 mm)	7" (177.8 mm)	2" (50.8 mm)	10" (254.0 mm)	0.79 lb (0.36 kg)
5127T	6	Knife Snap	Leather	Tunnel	2.5" (63.5 mm)	7" (177.8 mm)	2.5" (63.5 mm)	10" (254.0 mm)	0.87 lb (0.39 kg)
5125	5	Leather Tape Thong	No. 4 Canvas with Leather Back	Loops	2.25" (57.2 mm)	7.5" (190.5 mm)	2.25" (57.2 mm)	8.5" (215.9 mm)	0.63 lb (0.29 kg)
5125L	5	Leather Tape Thong	Leather	Loops	2.25" (57.2 mm)	7.5" (190.5 mm)	2.25" (57.2 mm)	8.5" (215.9 mm)	0.75 lb (0.34 kg)
5126	5	Knife Snap	Leather	Slotted	2" (50.8 mm)	6" (152.4 mm)	2" (50.8 mm)	8.75" (222.3 mm)	0.74 lb (0.34 kg)
5119	4	Knife Snap	Leather	Slotted	2" (50.8 mm)	6.5" (165.1 mm)	2" (50.8 mm)	8.5" (215.9 mm)	0.39 lb (0.18 kg)
5145	3	1" Reinforced Gusset	Leather	Tunnel	1" (25.4 mm)	5.25" (133.4 mm)	1" (25.4 mm)	7" (177.8 mm)	0.46 lb (0.21 kg)

Lineman's Pouches

- Black leather construction with double leather back for durability
- Rivet hole for belt connection
- Riveted to assure long life
- Includes knife snap, pockets for pliers, most screwdrivers, 6' (1.8 m) folding rule and open-ended wrenches
- Made in the USA with global components



Cat. No.	Number of Pockets	Special Features	Material	Belt Connection	Overall Length	Overall Width	Overall Height	Weight
5118P4	4	Knife Snap	Leather	Rivet Hole	8" (203.1 mm)	3" (76.2 mm)	11" (279.4 mm)	0.90 lb (0.41 kg)
5118P5	5	Knife Snap	Leather	Rivet Hole	10" (254.0 mm)	3" (76.2 mm)	11" (279.4 mm)	1.1 lb (0.5 kg)



Tool Pouches

Nail/Screw and Tool Pouches

- Split-leather construction, riveted and stitched for extra durability
- Large pockets have rolled-over doubled edges for extra-long life
- Heavy hammer loops. Cat. No. 42241 has hammer loops on both sides, allowing for convenient use by right- or left-handed workers
- Made in the USA with global components



Cat. No.	Number of Pockets	Special Features	Material	Belt Connection	Belt Width	Overall Length	Overall Width	Overall Height	Weight
42241	6	2 Hammer Loops	Leather	Tunnel	3" (76.2 mm)	11" (279.4 mm)	3" (76.2 mm)	11.75" (298.5 mm)	0.86 lb (0.39 kg)
42246	4	Left Hand Heavy Hammer Loop	Leather	Tunnel	Up to 3" (76.2 mm)	11.25" (285.8 mm)	2" (50.8 mm)	10.5" (266.7 mm)	0.72 lb (0.33 kg)
42245	4	Right Hand Heavy Hammer Loop	Leather	Tunnel	Up to 3" (76.2 mm)	11.25" (285.8 mm)	2" (50.8 mm)	10.5" (266.7 mm)	0.70 lb (0.32 kg)

Single-Pocket Tool Pouch

- Perfect for carrying pliers and other tools in the hip pocket
- Prevents wear and tearing of clothes, discomfort, and possible injury
- Riveted to assure long life
- Made in the USA with global components



Cat. No.	Number of Pockets	Material	Overall Length	Overall Width	Overall Height	Weight
5111	1	Leather	4.5" (114.3 mm)	1" (24.5 mm)	7" (177.8 mm)	0.23 lb (0.10 kg)

Back Pocket Pouches

- Stitched and riveted to assure long life
- Snap loop option for belt
- Made in the USA with global components

Cat. No.	Number of Pockets	Material	Belt Connection	Belt Width	Overall Length	Overall Width	Overall Height	Weight
5481	6	Leather	Snap Loop	Up to 2" (50.8 mm)	5.75" (146.1 mm)	2.5" (63.5 mm)	10" (254.0 mm)	0.47 lb (0.21 kg)
5482	4	Cordura® Ballistic Nylon	Snap Loop	Up to 2" (50.8 mm)	9.875" (250.8 mm)	2" (50.8 mm)	5" (127.0 mm)	0.26 lb (0.12 kg)



Tool Pouches

Nut & Bolt Pouch

- Includes interior pocket
- Top sides of pouch reinforced with leather to maintain shape of pouch opening
- Inside bottom is reinforced with leather and ventilating eyelet
- Metal snaps provided on loops for easy attachment to belts up to 3" (76 mm) wide
- Top edge reinforced with 1/4" (6 mm) rope
- Made in the USA with global components

Cat. No.	Number of Pockets	Material	Belt Connection	Belt Width	Overall Length	Overall Width	Overall Height	Weight
51A	1	No. 10 Canvas	Web Loop and Snap Hook	Up to 3" (76.2 mm)	9" (228.6 mm)	3.5" (88.9 mm)	10" (254.0 mm)	1.0 lb (0.5 kg)



51A

Leather Bolt Bag

- Split-leather construction
- Bolt bag with bull-pin loop on each side
- Made in the USA with global components

Cat. No.	Number of Pockets	Material	Belt Connection	Belt Width	Overall Length	Overall Width	Overall Height	Weight
42247	1	Leather	Tunnel	Up to 3" (76.2 mm)	5" (127.0 mm)	8.5" (215.9 mm)	8.5" (215.9 mm)	0.75 lb (0.34 kg)



42247

All-Purpose Bag

- Soft, pliable cushion leather construction
- For carrying loose tools and small parts
- Adjustable belt strap for attaching to belts
- Made in the USA with global components

Cat. No.	Number of Pockets	Material	Belt Connection	Belt Width	Overall Length	Overall Width	Overall Height	Weight
5146	1	Leather	Belt Strap	Up to 3" (76.2 mm)	9" (228.6 mm)	3" (76.2 mm)	8" (203.2 mm)	0.60 lb (0.27 kg)



5146

Strap-Leather Bag

- Soft, pliable cushion-leather gussets allow expansion to 3-1/4" (83 mm)
- Ventilating eyelet in bottom
- Made in the USA with global components

Cat. No.	Number of Pockets	Material	Belt Connection	Belt Width	Overall Length	Overall Width	Overall Height	Weight
5140K	1	Leather	Latigo Thongs	Up to 3" (76.2 mm)	7" (177.8 mm)	3.25" (82.6 mm)	9" (228.6 mm)	0.65 lb (0.29 kg)



5140K



Tool Pouches

Water-Repellent Canvas Pouches

- One-piece tan 10 oz. water-repellent mildew resistant canvas
- Top edge reinforced with 1/4" (6 mm) rope
- Made in the USA with global components

Cat. No.	Number of Pockets	Material	Belt Connection	Belt Width	Overall Length	Overall Width	Overall Height	Weight
5179	1	10 oz Canvas	Loops	Up to 4.5" (114.3 mm)	7.5" (190.5 mm)	7" (177.8 mm)	3.5" (88.9 mm)	0.30 lb (0.14 kg)
5179S	1	10 oz Canvas	Snap	Up to 4.5" (114.3 mm)	7.5" (190.5 mm)	7" (177.8 mm)	3.5" (88.9 mm)	0.30 lb (0.14 kg)



5179S

Canvas Utility Bags

- Includes interior pocket (Cat. Nos. 5141P and 5142P)
- Inside bottom is reinforced with cushion leather and ventilating eyelet
- Metal snaps provided on loops for easy attachment to belts up to 3" (76 mm) wide
- Top edge reinforced with 1/4" (6 mm) rope
- Made in the USA with global components

Cat. No.	Number of Pockets	Material	Belt Connection	Belt Width	Overall Length	Overall Width	Overall Height	Weight
5141P	2	No. 8 Canvas	Loops	Up to 3" (76.2 mm)	10" (254.0 mm)	5" (127.0 mm)	12" (304.8 mm)	0.88 lb (0.40 kg)
5142	1	No. 8 Canvas	Loops	Up to 3" (76.2 mm)	9" (228.6 mm)	8" (203.2 mm)	10" (254.0 mm)	0.60 lb (0.27 kg)
5142P	2	No. 8 Canvas	Loops	Up to 3" (76.2 mm)	9" (228.6 mm)	8" (203.2 mm)	10" (254.0 mm)	0.65 lb (0.29 kg)



5141P

Canvas Electrode Bags

- Made of tough No. 4 canvas
- Heat-resistant, hard leather bottom
- Cat. No. 5471FR is made of flame-resistant No. 4 canvas, features hard-leather bottom and meets the performance requirement of NFPA -701
- Tunnel loop for sliding over belt
- Made in the USA with global components

Cat. No.	Number of pockets	Material	Belt Connection	Belt Width	Diameter	Front Depth	Back Depth	Weight
5471	1	No. 4 Canvas	Tunnel	Up to 3" (76.2 mm)	2-1/2" (63.5 mm)	12" (304.8 mm)	15.5" (393.7 mm)	0.25 lb (0.11 kg)
5471FR	1	No. 4 Canvas	Tunnel	Up to 3" (76.2 mm)	2-1/2" (63.5 mm)	12" (304.8 mm)	15.5" (393.7 mm)	0.25 lb (0.11 kg)



5471

5471FR

Tool Pouches

Bull-Pin and Bolt Bags

- Made of flame-resistant No. 4 canvas and meets the performance requirement of NFPA - 701 (Cat. No. 5416TFR)
- Bolt bag with bull-pin loop on each side
- Two D-rings on the front of the pouch and four on the inside to offer plenty of space to connect tethers, and buckle at top for closing (Cat. No. 5416OCTO)
- Drain holes to release any water build-up (Cat. No. 5416TSR)
- Made in the USA with global components



Cat. No.	Number of Pockets	Material	Belt Connection	Belt Width	Overall Length	Overall Width	Overall Height	Weight
5416	3	No. 4 Canvas	Loops	Up to 3" (76.2 mm)	5" (127.0 mm)	10" (254.0 mm)	9" (228.6 mm)	0.85 lb (0.39 kg)
5416T	3	No. 4 Canvas	Tunnel	Up to 3" (76.2 mm)	5" (127.0 mm)	10" (254.0 mm)	9" (228.6 mm)	0.90 lb (0.41 kg)
5416TBR	1	No. 4 Canvas	Tunnel	Up to 3" (76.2 mm)	5" (127.0 mm)	10" (254.0 mm)	9" (228.6 mm)	0.99 lb (0.45 kg)
5416TFR	3	Flame-Resistant No. 4 Canvas	Tunnel	Up to 3" (76.2 mm)	5" (127.0 mm)	10" (254.0 mm)	9" (228.6 mm)	0.90 lb (0.41 kg)
NEW 5416TSR	1	No. 4 Canvas	Tunnel	Up to 3" (76.2 mm)	5" (127.0 mm)	9" (228.6 mm)	10" (254.0 mm)	0.9 lb (0.4 kg)
5416TC	2	No. 4 Canvas	Tunnel	Up to 3" (76.2 mm)	5" (127.0 mm)	10" (254.0 mm)	9" (228.6 mm)	0.87 lb (0.39 kg)
5416TCP	3	No. 4 Canvas	Tunnel	Up to 3" (76.2 mm)	5" (127.0 mm)	12" (304.8 mm)	9" (228.6 mm)	1.0 lb (0.5 kg)
5416L	1	Leather	Tunnel	Up to 3" (76.2 mm)	5" (127.0 mm)	10" (254.0 mm)	9" (228.6 mm)	1.1 lb (0.5 kg)
5416OCTO	3	No. 4 Canvas	Loop	Up to 3" (76.2 mm)	5" (127.0 mm)	5" (127.0 mm)	9" (228.6 mm)	0.75 lb (0.34 kg)



Tool Combination Aprons

One-Piece Nail/Screw and Tool Pouch Apron

- Split-leather construction
- Versatile, roomy double-pouch apron for construction workers, carpenters, and other professionals
- Riveted and stitched for extra durability
- Four slots for punches or nail sets
- Two heavy-duty hammer loops
- Double-pouch design allows unrestricted leg movement
- Apron is reinforced throughout with rivets
- The large pockets and nail/bolt pockets have rolled-over, doubled edges for long wear
- Heavy-duty 2" (51 mm) wide polypropylene web belt has rugged adjustable metal buckle
- Made in the USA with global components



42242

Cat. No.	Number of Pockets	Size	Belt Width	Overall Length	Overall Height	Overall Width	Weight
42242	10	One Size	2.25" (57.2 mm)	54" (1371.6 mm)	9.5" (241.3 mm)	5.5" (139.7 mm)	1.8 lb (0.8 kg)

Nail/Screw and Tool Pouch Combinations

- Split-leather construction
- Large pockets have rolled-over doubled edges for extra-long life
- All pouches slide along belt for convenient working position
- Left- and right-hand nail-and-tool pouches with tunnel loop connection
- Heavy-duty 2" (51 mm) wide polypropylene web belt has rugged metal buckle and is adjustable from 32" (812.8 mm) to 48" (1219.2 mm)
- Tape-rule holder for 20' (6 m) and 25' (7.5 m) tape measures with belt clips
- Heavy hammer loops
- Made in the USA with global components



42244

Cat. No.	Kit Contains	Weight
42244	Nail/Screw and Tool-Pouch Combination	2.0 lb (0.9 kg)
Cat. No.	Description	
42245	Right-Hand Nail and Tool Pouch	
42246	Left-Hand Nail and Tool Pouch	
5225	Adjustable PolyWeb Tool Belt	
5195	Tape Measure Holder, Leather, Medium	

Electrician's Tool Apron

- Made of heavy-duty canvas
- Deep pockets to fit your tools
- Loops for extra tool storage
- Tape measure holder
- Special pockets for writing utensils
- Riveted to assure long life
- Made in the USA with global components



42200

Cat. No.	Size	Belt Width	Number of Pockets	Overall Length	Overall Height	Overall Width	Weight
42200	M/L	1.5" (38.1 mm)	6	52" (132.1 mm)	7.75" (196.9 mm)	4" (101.6 mm)	0.86 lb (0.39 kg)
42201	XL/2XL	1.5" (38.1 mm)	6	55.5" (1409.7 mm)	11.5" (292.1 mm)	5" (127.0 mm)	0.93 lb (0.42 kg)

See page 297 for additional information on warnings.

WARNING: This is NOT an occupational protective belt.

WARNING: NOT for fall arrest or back support.

Tool Holders

Tool Holders

- Black leather construction
- Riveted to assure long life
- Made in the USA with global components



Cat. No.	For Use With	Number of Pockets	Belt Connection	Belt Width	Overall Length	Overall Width	Overall Height	Weight
5118C	7" to 9" Side-cutting Pliers, Most Screwdrivers, 6" Folding Rules and Open-ended Wrenches from 9/16" to 13/16"	4	Slotted	Up to 2" (50.8 mm)	6.5" (165.1 mm)	2" (50.8 mm)	11" (279.4 mm)	0.78 lb (0.35 kg)
5118PRS	7" to 9" Side-cutting Pliers, Most Screwdrivers and 6" Folding Rules	3	Slotted	Up to 2" (50.8 mm)	6.75" (171.5 mm)	2" (50.8 mm)	10" (254.0 mm)	0.49 lb (0.22 kg)
S5118PRS	7" to 9" Side-cutting Pliers, Most Screwdrivers and 6" Folding Rules	3	Slotted	Up to 2" (50.8 mm)	6.75" (171.5 mm)	2" (50.8 mm)	10" (254.0 mm)	0.56 lb (0.25 kg)
5118R	7" to 9" Side-cutting Pliers and 6" Folding Rules	2	Slotted	Up to 2" (50.8 mm)	4.75" (120.7 mm)	2" (50.8 mm)	8" (203.2 mm)	0.43 lb (0.20 kg)
5118RT	7" to 9" Side-Cutting Pliers and 6" Folding Rules	2	Tunnel	Up to 3.75" (95.3 mm)	4.5" (114.3 mm)	2" (50.8 mm)	12.5" (317.5 mm)	0.50 lb (0.23 kg)
5118S	7" to 9" Side-cutting Pliers and Most Screwdrivers	2	Slotted	Up to 2" (50.8 mm)	4.25" (108 mm)	2" (50.8 mm)	10.75" (273.1 mm)	0.35 lb (0.16 kg)
5107-6	6" or 7" Long-nose or Diagonal-cutting Pliers	1	Slotted	Up to 2" (50.8 mm)	3.5" (88.9 mm)	1.125" (28.6 mm)	8.5" (215.9 mm)	0.17 lb (0.08 kg)
5107-9	8" or 9" Long-nose or Diagonal-cutting Pliers	1	Slotted	Up to 2" (50.8 mm)	3.75" (95.3 mm)	1.125" (28.6 mm)	11" (279.4 mm)	0.26 lb (0.12 kg)
5112	7" to 9" Side-cutting Pliers	1	Slotted	Up to 2" (50.8 mm)	3.25" (82.6 mm)	1" (25.4 mm)	11" (279.4 mm)	0.21 lb (0.10 kg)
5100M	Klein Scissor Snips or Shears	1	Tunnel	Up to 2" (50.8 mm)	2" (50.8 mm)	1" (25.4 mm)	8" (203.2 mm)	0.15 lb (0.07 kg)
5101	Klein Electrician's Scissors	1	Tunnel	Up to 1.5" (38.1 mm)	2" (50.8 mm)	1" (25.4 mm)	7" (177.8 mm)	0.11 lb (0.05 kg)
5187	Klein Electrician's Scissors and Cable-splicer's Knife	2	Slotted	Up to 2.25" (57.2 mm)	2" (50.8 mm)	1.25" (31.8 mm)	7.25" (184.2 mm)	0.11 lb (0.05 kg)
5187T	Klein Electrician's Scissors and Cable-splicer's Knife	2	Tunnel	Up to 2.25" (57.2 mm)	2" (50.8 mm)	1" (25.4 mm)	7.25" (184.2 mm)	0.13 lb (0.06 kg)
5188	Klein Cable-splicer's Knife	1	Slotted	Up to 2.25" (57.2 mm)	2.125" (54 mm)	1" (25.4 mm)	7.75" (196.9 mm)	1.3 oz (37 g)
5188T	Klein Cable-splicer's Knife	1	Tunnel	Up to 2.25" (57.2 mm)	2.125" (54 mm)	1" (25.4 mm)	7.25" (184.2 mm)	0.11 lb (0.05 kg)
5163	Klein Skinning Knives	1	Slotted	Up to 2" (50.8 mm)	3.5" (88.9 mm)	1" (25.4 mm)	9.375" (238.1 mm)	0.21 lb (0.10 kg)
5185	Klein Utility Knives	1	Slotted	Up to 2.5" (63.5 mm)	2.625" (66.7 mm)	0.75" (19.1 mm)	8.25" (209.6 mm)	0.11 lb (0.05 kg)
5129	Standard Two-cell Flashlight	1	Slotted	Up to 2.25" (57.2 mm)	3" (76.2 mm)	2.25" (57.2 mm)	9.5" (241.3 mm)	0.22 lb (0.10 kg)



Tool Holders

Tape Measure Holders

- Leather construction
- Cut-out sides for easy access to tape
- Slotted for attaching to belts up to 2-1/2" (63 mm) wide
- Riveted to assure long life
- Made in the USA with global components



Klein Tape Measure Sizing Guide

Tape Measure	Holder Cat. No.	Description
86216, 86315	5195	Medium Leather Pouch
86125, 86225, 86375	5196	Large Leather Pouch
86230	5196	Large Leather Pouch

Cat. No.	Description	Belt Connection	Belt Width	Overall Length	Overall Width	Overall Height	Weight
5194	Small Tape Measure Holder	Slotted	Up to 2.5" (63.5 mm)	4" (101.6 mm)	2" (50.8 mm)	6" (152.4 mm)	0.16 lb (0.07 kg)
5195	Tape Measure Holder, Leather, Medium	Slotted	Up to 2.5" (63.5 mm)	4.5" (114.3 mm)	3" (76.2 mm)	7" (177.8 mm)	0.18 lb (0.08 kg)
5196	Leather Tape Measure Holder, Large	Slotted	Up to 2.5" (63.5 mm)	5" (127.0 mm)	2" (50.8 mm)	7" (177.8 mm)	0.21 lb (0.10 kg)

Hammer Holders

- Black leather construction
- Heavy-metal hammer loop riveted to panel
- Riveted and stitched to assure long life
- Holds most Klein hammers except lineman's and mining/specialty hammers
- Made in the USA with global components

Cat. No.	Material	Belt Connection	Belt Width	Overall Length	Overall Width	Overall Height	Weight
5456	Leather	Slotted	Up to 2.5" (63.5 mm)	4.313" (109.6 mm)	2.5" (63.5 mm)	7.875" (200 mm)	0.33 lb (0.15 kg)
5456T	Leather	Tunnel	Up to 4" (101.6 mm)	4.313" (109.6 mm)	3" (76.2 mm)	10" (254.0 mm)	0.42 lb (0.19 kg)
5456TS	Leather	Tunnel	Up to 4" (101.6 mm)	4.313" (109.6 mm)	3" (76.2 mm)	10" (254.0 mm)	0.42 lb (0.19 kg)



Bull-Pin Holders

- Riveted to assure long life
- Holds all standard bull pins
- Made in the USA with global components

Cat. No.	Material	Belt Connection	Belt Width	Overall Length	Overall Width	Overall Height	Weight
5417	Leather	Slotted	Up to 2" (50.8 mm)	3.25" (82.6 mm)	2" (50.8 mm)	11" (279.4 mm)	0.22 lb (0.10 kg)
5417T	Leather	Tunnel	Up to 3.5" (88.9 mm)	3.25" (82.6 mm)	3" (76.2 mm)	12.25" (311.2 mm)	0.32 lb (0.15 kg)



Erection Wrench Holders

- Has tool slots for two erection wrenches
- Cat. No. 5461T has cotton web tunnel loop
- Tunnel loop on Cat. No. 5459T and 5461T is riveted to assure long life
- Holds erection wrenches and adjustable head construction wrench Cat. No. 3239
- Made in the USA with global components

Cat. No.	Material	Belt Connection	Belt Width	Overall Length	Overall Width	Overall Height	Weight
5459T	Leather	Tunnel	Up to 3.5" (88.9 mm) or to Slide Over D-Rings, Buckles, and Other Accessories	6" (152.4 mm)	1.5" (38.1 mm)	9.5" (241.3 mm)	0.32 lb (0.15 kg)
5460	Leather	Slotted	Up to 2" (50.8 mm)	6" (152.4 mm)	2" (50.8 mm)	8.5" (215.9 mm)	0.19 lb (0.09 kg)
5461T	Leather	Cotton Web Tunnel	Up to 2" (50.8 mm)	6" (152.4 mm)	1" (25.4 mm)	10" (254.0 mm)	0.26 lb (0.12 kg)



Tool Holders

Tie-Wire Reel Pad

- Worn on the belt under the Klein® tie-wire reel (Cat. No. 27400)
- Made of 3/16" (5 mm) thick rigging leather
- Underside has a sponge-rubber pad to minimize hip fatigue
- Made in the USA with global components



27450

Cat. No.	Belt Connection	Belt Width	Overall Length	Overall Width	Overall Height	Weight
27450	Slotted	Up to 2" (50.8 mm)	7" (177.8 mm)	7" (177.8 mm)	0.75" (19.1 mm)	0.30 lb (0.14 kg)

Tie-wire reel and ironworker's heavy-duty tie-wire belts also available.

Tape Thong

- Leather strap with fiber bar
- Fits all standard electrical tape rolls
- Made in the USA with global components



5130

Cat. No.	Belt Connection	Overall Length	Overall Width	Overall Height	Weight
5130	Slotted	12" (304.8 mm)	4" (101.6 mm)	1" (25.4 mm)	0.48 oz (13.6 g)

Connecting Bar Holder with Lock Collar

- Fits Klein® 7/8" (22 mm) connecting bars (Cat. Nos. 3246 and 3248)
- Leather construction
- Tunnel loop allows for weight distribution on belt
- Fits belts up to 3-1/2" (89 mm) wide
- Replacement lock collar (Cat. No. 5459C) available
- Made in the USA with global components

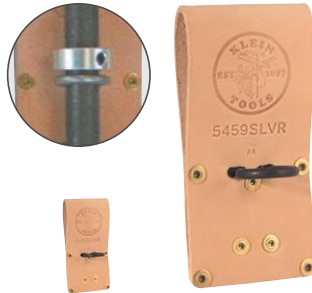

5459C

5459SLVR

Cat. No.	Belt Connection	Belt Width	Overall Length	Overall Width	Overall Height	Weight
5459SLVR	Tunnel	Up to 3.5" (88.9 mm)	3" (76.2 mm)	2" (50.8 mm)	6.75" (171.5 mm)	0.40 lb (0.18 kg)

Snap Loop

- Black leather construction
- Designed for tools with hang holes
- Loop with snap hook for carrying an adjustable wrench, welder's igniter or other tool with hang hole
- Riveted to assure long life
- Made in the USA with global components



5458

Cat. No.	Belt Connection	Belt Width	Overall Length	Overall Width	Overall Height	Weight
5458	Slides On	Up to 4" (101.6 mm)	1.5" (38.1 mm)	0.5" (12.7 mm)	8.5" (215.9 mm)	0.15 lb (0.07 kg)

⚠WARNING: Lock collar should ONLY be used on Klein 7/8" connecting bars
Lock collar must be installed on connecting bar before using holder.

Tool Guards

Axe Guard

- Protect both tool and user with a Klein guard for your edged tools
- Made of 1/16" (1.6 mm) vulcanized hard fiber, securely riveted and equipped with adjustable web straps to hold the tool
- Made in the USA with global components



5509

Cat. No.	For Use With	Weight
5509	Edged Tools	0.22 lb (0.10 kg)

Splitting-Knife Guards

- Leather construction
- Made in the USA with global components



5574L

Cat. No.	For Use With	Weight
5574L	Klein Knife, Cat. No. 1515-1	0.13 lb (0.06 kg)
5574S	Klein Knife, Cat. No. 1515-S	0.80 oz (22.7 g)



Tool Pouches and Carriers

TRADESMAN PRO™

Electrician's Tool Belt



55427

- 26 pockets for easy tool storage
- Wide open pockets for tools, drills and spare parts
- Removable pouches allow you to carry only the tools needed
- Handles for easy carrying
- Loop tape measure holder
- Padded belt with mesh interior is breathable and comfortable
- Rugged leather belt ends
- Attachments for Tradesman Pro™ padded suspenders (Cat. No. 55400)

Cat. No.	Description	Waist Size	Overall Width	Weight
55427	Tradesman Pro™ Electrician's Tool Belt, Medium	31" to 34" (787.4 to 863.6 mm)	46" (1168.4 mm)	4.2 lb (1.9 kg)
55428	Tradesman Pro™ Electrician's Tool Belt, Large	35" to 39" (889.0 to 990.6 mm)	50.5" (1282.7 mm)	4.2 lb (1.9 kg)
55429	Tradesman Pro™ Electrician's Tool Belt, XL	40" to 44" (101.6 to 111.8 cm)	55.5" (1409.7 mm)	4.3 lb (2.0 kg)

⚠WARNING: This is NOT an occupational protective belt. NOT for fall arrest or back support.

15-Pocket Tool Pouch

- Heavy duty reinforced bottom
- Features multiple pockets of various sizes, plus a tape thong
- Great for carrying a mix of tools and job site consumables
- Includes a padded shoulder strap for easy carrying to use without a belt



5243

Cat. No.	Number of Pockets	Material	Belt Connection	Belt Width	Overall Length	Overall Width	Overall Height	Weight
5243	15	1680d Ballistic Weave	Tunnel	Up to 2" (50.8 mm)	11.5" (292.1 mm)	10" (254.0 mm)	11.5" (292.1 mm)	1.8 lb (0.8 kg)

9-Pocket Tool Pouch

- Heavy duty reinforced bottom
- Deep center pocket and closed front pocket to carry small parts
- Includes an array of other pockets for various tools, plus a tape thong
- Convenient handle for "pick up and go" mobility; shoulder strap for hands free carry



5242

Cat. No.	Number of Pockets	Material	Belt Connection	Belt Width	Overall Length	Overall Width	Overall Height	Weight
5242	9	1680d Ballistic Weave	Tunnel	Up to 2" (50.8 mm)	9.5" (241.3 mm)	7.5" (190.5 mm)	9.5" (241.3 mm)	1.2 lb (0.5 kg)

See page 297 for additional information on warnings.

⚠WARNING: This is NOT an occupational protective belt.

⚠WARNING: NOT for fall arrest or back support.

TRADESMAN PRO™

Tool Pouches and Carriers

6-Pocket Tool Pouch

- Heavy duty reinforced bottom
- Features one deep center pocket, five outside pockets, plus tape thong
- Carry a variety of screwdrivers and other tools



5241

Cat. No.	Number of Pockets	Material	Belt Connection	Belt Width	Overall Length	Overall Width	Overall Height	Weight
5241	6	1680d Ballistic Weave	Tunnel	Up to 2" (50.8 mm)	10.25" (260.4 mm)	6.75" (171.5 mm)	10.25" (260.4 mm)	0.81 lb (0.37 kg)

Maintenance Pouch

- Just enough pockets for your essential tools
- Includes a tape thong
- Easy grab and go styling keeps your basic tools right at hand



5240

Cat. No.	Number of Pockets	Material	Belt Connection	Belt Width	Overall Length	Overall Width	Overall Height	Weight
5240	9	1680d Ballistic Weave	Tunnel	Up to 2" (50.8 mm)	10.25" (260.4 mm)	5.5" (139.7 mm)	10.25" (260.4 mm)	0.39 lb (0.18 kg)

Drill Pouch

- Fits most impact and battery drills
- Strap closure keeps drill in place
- Pockets for a variety of drill bits



5183

Cat. No.	Number of Pockets	Material	Belt Connection	Belt Width	Overall Length	Overall Width	Overall Height	Weight
5183	8	1680d Ballistic Weave	Tunnel	Up to 2" (50.8 mm)	7.25" (184.2 mm)	3" (76.2 mm)	12.25" (311.2 mm)	0.47 lb (0.21 kg)

4-Pocket Tool Apron

- Heavy duty reinforced bottom so tools won't poke through
- Two large open pockets for parts
- Two pockets for assorted tools
- Includes pencil/marker pockets and a tape thong
- Adjustable belt fits waist sizes 32" (812.8 mm) to 53" (1346.2 mm)



5244

⚠ WARNING: The tool belt is not an occupational protective belt.

Cat. No.	Number of Pockets	Size	Belt Width	Overall Length	Overall Height	Overall Width	Weight
5244	6	Adjustable	1.875" (47.6 mm)	0.5" (12.7 mm)	10.5" (266.7 mm)	19" (482.6 mm)	1.4 lb (0.7 kg)



Holders, Belts & Suspenders

TRADESMAN PRO™

Padded Tool Belt

- 2 inch wide belt features padded liner with breathable mesh interior
- Thick, rugged leather belt ends
- Side handles for ease of lifting
- Includes metal connection points to attach suspenders for extra support



5247

Cat. No.	Waist Size	Belt Width	Overall Length	Overall Width	Weight
5245	31" to 34" (787.4 to 863.6 mm)	2" (50.8 mm)	44.5" (113 cm)	5" (127.0 mm)	1.0 lb (0.5 kg)
5246	35" to 39" (889.0 to 990.6 mm)	2" (50.8 mm)	49" (124.5 cm)	5" (127.0 mm)	1.3 lb (0.6 kg)
5247	40" to 44" (101.6 to 111.8 cm)	2" (50.8 mm)	54" (137.2 cm)	5" (127.0 mm)	1.0 lb (0.5 kg)

Knife Holder

- Holds up to a 4-1/2" (114.3 mm) knife
- Metal clip attaches securely to belt or pocket
- Magnetic closure keeps top flap firmly in place



5248

Cat. No.	Material	Overall Length	Overall Width	Overall Height	Weight
5248	1680d Ballistic Weave	5.25" (133.4 mm)	2.5" (63.5 mm)	5.25" (133.4 mm)	0.19 lb (0.09 kg)

Padded Suspenders

- Tear resistant
- Fully adjustable
- Durable nylon web straps for long wear
- Heavy duty padding for comfort
- Easy snap hook fastening system



55400

Cat. No.	Color	Size	Strap Width	Weight
55400	Black	One Size Fits Most	1.5" (38.1 mm)	0.84 lb (0.38 kg)

Hard Cases

- Hard shell protects tools, meters, small parts and tech devices
- Soft interior lining
- Durable zipper closure



5189



5184

Cat. No.	Number of Pockets	Overall Length	Overall Height	Overall Width	Weight
5184	1	8.75" (222.3 mm)	2.25" (57.2 mm)	6.5" (165.1 mm)	0.63 lb (0.29 kg)
5189	1	10.25" (260.4 mm)	2.25" (57.2 mm)	5.5" (139.7 mm)	0.63 lb (0.29 kg)

See page 297 for additional information on warnings.

WARNING: This is NOT an occupational protective belt.

WARNING: NOT for fall arrest or back support.

TRADESMAN PRO™

Holders, Belts & Suspenders

Carrying Cases

- Two layers of padding protect even delicate instruments
- Heavy-duty zipper and rugged PVC coated polyester for durability
- One interior and one exterior pocket for quick access and organization
- Sturdy handle with box stitching for secure transportation and convenient hanging. Constructed of 1680d ballistic weave
- Cat. Nos. 69406 and 69407 recommended for meters, testers, infrared guns, and small tools
- Cat. No. 69408 is recommended for meters, testers, borescopes, infrared guns and tools
- Made in the USA with global components



Cat. No.	Number of Pockets	Overall Length	Overall Height	Overall Width	Weight
69406	1	9.25" (235 mm)	2.25" (57.2 mm)	4.5" (114.3 mm)	0.38 lb (0.17 kg)
69407	2	10.25" (260.4 mm)	2.25" (57.2 mm)	6" (152.4 mm)	0.53 lb (0.24 kg)
69408	2	10.25" (260.4 mm)	2.25" (57.2 mm)	7" (177.8 mm)	0.66 lb (0.30 kg)

Mobile Phone Holders

- Fits iPhone® and Samsung® and equivalent sized phones as listed
- XX-Large holder Cat. No. 55474 easily accommodates your phone inside its protective case
- Metal clip for attaching to belts up to 2" wide
- Magnetic flap closure
- Constructed of 1680d ballistic weave



Realtree AP-XTRA Camouflage Design
© 2012 of Jordan Outdoor Enterprises, Ltd., all rights reserved.

Cat. No.	Size	Fits iPhone® or Equivalent Size	Fits Samsung® or Equivalent Size	Overall Length	Overall Width	Overall Height	Weight
55460	Small	4, 5		1.5" (38.1 mm)	2.906" (73.8 mm)	5.75" (146.1 mm)	0.22 lb (0.10 kg)
55461	Large	6, 7, 7S, 8, X	Galaxy S3, S4, S7	1.5" (38.1 mm)	3.297" (83.7 mm)	6" (149.2 mm)	0.32 lb (0.15 kg)
55468	X-Large	6 Plus, 7 Plus	Galaxy Note® Edge, Note® 7	1.5" (38.1 mm)	3.75" (95.3 mm)	6.75" (171.5 mm)	0.42 lb (0.19 kg)
NEW 55474	XX-Large	6 Plus, 7 Plus, 8 Plus	Galaxy® S7, S8, S8 Plus, S9, S9 Plus, Note® 7, Note® 8, Note® Edge	1.5" (38.1 mm)	3.86" (98.4 mm)	7.13" (182.9 mm)	
55563	Large	6, 7, 7s, 8, X	Galaxy® S3, S4, S7	1.5" (38.1 mm)	3.297" (83.7 mm)	6" (152.4 mm)	0.26 lb (0.12 kg)
55564	X-Large	6 Plus, 7 Plus	Galaxy Note® Edge, Note® 7	1.5" (38.1 mm)	3.75" (95.3 mm)	6.75" (171.5 mm)	0.26 lb (0.12 kg)

iPhone® is a registered trademark of Apple, Inc., Galaxy S® is a registered trademark of Samsung Electronics Co., Ltd., Realtree AP-XTRA Camouflage Design © 2012 of Jordan Outdoor Enterprises, Ltd., all rights reserved.

Tool Pouches, Carriers, Belts & Suspenders

PowerLine™ Series



Constructed of double layered 1000 denier washable Cordura® fabric

Double nylon-stitched and rivet reinforced for extra durability

Lightweight and comfortable in warm climates, soft and pliable in cold climates

Oversized pockets and reinforced bottom for extra carrying capacity, as well as durability

Exceptional resistance to abrasion, punctures, and tearing

No break-in period; naturally forms and hugs the body, making it easy to wear for everyday use

Heavy-duty, nylon webbing

Washable

Cordura® is a registered trademark of INVISTA for durable fabrics



Tool Pouches



Cat. No.	Number of Pockets	Belt Connection	Belt Width	Overall Length	Overall Width	Overall Height	Weight
5700	9	Tunnel	2.5" (63.5 mm)	11" (279.4 mm)	3" (76.2 mm)	12" (304.8 mm)	0.92 lb (0.42 kg)
5701	8	Tunnel	2.5" (63.5 mm)	11" (279.4 mm)	6" (152.4 mm)	12" (304.8 mm)	0.83 lb (0.38 kg)
5702	2	Tunnel	2.5" (63.5 mm)	11" (279.4 mm)	2" (50.8 mm)	12" (304.8 mm)	0.64 lb (0.29 kg)
5703	3	Tunnel	2.5" (63.5 mm)	11" (279.4 mm)	2" (50.8 mm)	12" (304.8 mm)	0.75 lb (0.34 kg)
5718	8	Tunnel	2.5" (63.5 mm)	11" (279.4 mm)	2.25" (57.2 mm)	12" (304.8 mm)	0.74 lb (0.34 kg)
5719	18	Tunnel	2.5" (63.5 mm)	11" (279.4 mm)	3.75" (95.3 mm)	12" (304.8 mm)	0.87 lb (0.39 kg)

Cordura® is a registered trademark of INVISTA for durable fabrics.

PowerLine™ Series

Pouches, Holders, & Suspenders

Tape Measure Pouch

Includes core PowerLine™ features plus:

- Holds most 35-foot (11 m) tape measures, fasteners, nails, or wire nuts
- Two inside elastic loops fit screwdrivers, pencils, markers, etc.
- Made in the USA with global components



5712

Cat. No.	Belt Connection	Belt Width	Overall Length	Overall Width	Overall Height	Weight
5712	Tunnel	Up to 2.25" (57.2 mm)	8.25" (209.6 mm)	2.25" (57.2 mm)	4.5" (114.3 mm)	0.24 lb (0.11 kg)

Closeable Pouch

Includes core PowerLine™ features plus:

- Closeable pouch helps protect supplies and tools
- Made in the USA with global components



5714

Cat. No.	Belt Connection	Belt Width	Overall Length	Overall Width	Overall Height	Weight
5714	Tunnel	Up to 2.25" (57.2 mm)	7.5" (190.5 mm)	2.25" (57.2 mm)	6.75" (171.5 mm)	0.24 lb (0.11 kg)

Multi-Purpose Holder

Includes core PowerLine™ features plus:

- Holds a flashlight, cellular phone, or electrical tester
- Made in the USA with global components



5708

Cat. No.	Belt Connection	Belt Width	Overall Length	Overall Width	Overall Height	Weight
5708	Tunnel	Up to 2.25" (57.2 mm)	3.25" (82.6 mm)	1" (25.4 mm)	8.5" (215.9 mm)	0.13 lb (0.06 kg)

Flashlight Holder

Includes core PowerLine™ features plus:

- Accommodates most "D" cell size battery flashlights up to 1-7/8" (48 mm) in diameter
- Heavy-duty, 1-1/2" (38 mm) wide nylon webbing for extra strength
- Riveted to assure long life
- Made in the USA with global components



5713

Cat. No.	Belt Connection	Belt Width	Overall Length	Overall Width	Overall Height	Weight
5713	Tunnel	Up to 2.25" (57.2 mm)	4.25" (108 mm)	2.25" (57.2 mm)	2.375" (60.3 mm)	1.0 oz (28 g)

Tape Measure Holder

Includes core PowerLine™ features plus:

- Holds most tape measures with belt clips
- Stainless steel clip holder accepts most tape clips up to 1-3/4" (44 mm) wide
- Made in the USA with global components



5707

Cat. No.	Belt Connection	Belt Width	Overall Length	Overall Width	Overall Height	Weight
5707	Tunnel	Up to 2.25" (57.2 mm)	4.125" (104.8 mm)	2.25" (57.2 mm)	3.75" (95.3 mm)	0.10 lb (0.05 kg)

Hammer Holder

Includes core PowerLine™ features plus:

- Heavy-metal hammer loop riveted for additional strength
- Made in the USA with global components



5706

Cat. No.	Belt Connection	Belt Width	Overall Length	Overall Width	Overall Height	Weight
5706	Tunnel	Up to 2.25" (57.2 mm)	4.125" (104.8 mm)	2.25" (57.2 mm)	3.75" (95.3 mm)	0.19 lb (0.09 kg)

Utility Knife Holder

Includes core PowerLine™ features plus:

- Holds standard utility knife or other small tools
- Made in the USA with global components



5716

Cat. No.	Belt Connection	Belt Width	Overall Length	Overall Width	Overall Height	Weight
5716	Tunnel	Up to 2.25" (57.2 mm)	7.75" (196.9 mm)	1" (25.4 mm)	2.5" (63.5 mm)	0.15 lb (0.07 kg)

Padded Suspenders

Includes core PowerLine™ features plus:

- Fully adjustable length - front and back
- Heavy-duty, 1-1/2" (38 mm) wide nylon web strap for extra strength and long wear
- Convenient fastening system features genuine VELCRO® brand touch fasteners
- Heavy-duty padding for user comfort
- Made in the USA with global components



5717

Cat. No.	Size	Strap Width	Weight
5717	One Size Fits Most	1.5" (38.1 mm)	0.84 lb (0.38 kg)

Velcro® is a registered trademark of Velcro Industries B.V.



Belts & Combo Sets

PowerLine™ Series

Adjustable Web Work Belt



5705

Includes core PowerLine™ features plus:

- Heavy-duty, 2" (51 mm) wide nylon webbing for extra strength
- Accommodates tunnel loop and slotted tool pouches and holders
- Rugged metal buckle for quick release and adjustment
- Made in the USA with global components

Cat. No.	Waist Size	Overall Width	Weight
5705	One Size Fits up to 54" (137.2 cm) Waist	2" (50.8 mm)	0.56 lb (0.25 kg)

Padded Tool Belts



5704L

Includes core PowerLine™ features plus:

- 5" (17 mm) cushioned pad for stability and comfort
- Tapered front for comfort while bending
- Heavy-duty 2" (51 mm) wide nylon web belt with rugged metal buckle
- Made in the USA with global components

Cat. No.	Waist Size	Overall Width	Weight
5704M	32" to 36" (812.8 to 914.4 mm)	2" (50.8 mm)	0.95 lb (0.43 kg)
5704L	36" to 40" (91.4 to 101.6 cm)	2" (50.8 mm)	1.0 lb (0.5 kg)
5704XL	40" to 44" (101.6 to 111.8 cm)	2" (50.8 mm)	1.1 lb (0.5 kg)

4-Piece Combo Sets

Includes core PowerLine™ features plus:

- 8-Pocket Tool Pouch (Cat. No. 5701)
- 3-Pocket Utility Pouch (Cat. No. 5703)
- Hammer Holder (Cat. No. 5706)
- Sized Padded Tool Belt (Cat. No. 5704M, 5704L or 5704XL)
- Made in the USA with global components



5709L

Cat. No.	Belt Width	Waist Size	Weight
5709M	2" (50.8 mm)	32" to 36" (812.8 to 914.4 mm)	2.7 lb (1.2 kg)
5709L	2" (50.8 mm)	36" to 40" (91.4 to 101.6 cm)	2.8 lb (1.3 kg)
5709XL	2" (50.8 mm)	40" to 44" (101.6 to 111.8 cm)	2.8 lb (1.3 kg)

4-Piece Electrician's Combo Sets

Includes core PowerLine™ features plus:

- 8-Pocket Tool Pouch (Cat. No. 5718)
- 19-Pocket Tool Pouch (Cat. No. 5719)
- Hammer Holder (Cat. No. 5706)
- Sized Padded Tool Belt (Cat. No. 5704M, 5704L or 5704XL)
- Made in the USA with global components



5710M

Cat. No.	Belt Width	Waist Size	Weight
5710M	2" (50.8 mm)	32" to 36" (812.8 to 914.4 mm)	2.8 lb (1.3 kg)
5710L	2" (50.8 mm)	36" to 40" (91.4 to 101.6 cm)	2.8 lb (1.3 kg)
5710XL	2" (50.8 mm)	40" to 44" (101.6 to 111.8 cm)	3.1 lb (1.4 kg)

See page 297 for additional information on warnings.

⚠WARNING: This is NOT an occupational protective belt.

⚠WARNING: NOT for fall arrest or back support.

Tool Belts

Tool Belts

- Strong, black leather construction
- Designed to carry lightweight tool pouches (Cat. No. 5201)
- Removable single-tongue buckle held by two heavy-duty snaps (Cat. No. 5202 Series)
- Made in the USA with global components

Cat. No.	Waist Size	Overall Width	Weight
5201	33" to 45" (83.8 to 114.3 cm)	1" (25.4 mm)	0.30 lb (0.14 kg)
5202M	32" to 40" (81.3 to 101.6 cm)	1.5" (38.1 mm)	0.40 lb (0.18 kg)
5202L	38" to 46" (96.5 to 116.8 cm)	1.5" (38.1 mm)	0.45 lb (0.20 kg)
5202XL	46" to 54" (116.8 to 137.2 cm)	1.5" (38.1 mm)	0.50 lb (0.23 kg)



5202L

Lightweight Utility Belt

- Strong, lightweight blue polypropylene web
- Quickly adjusts for waist sizes through 56" (142.2 cm)
- Accepts tunnel-loop and slotted pouches and holders
- Tough, molded, non-metallic, slide-action buckle provides single-handed, quick release and adjustment
- Made in the USA with global components

Cat. No.	Waist Size	Overall Width	Weight
5204	Up to 56" (142.2 cm)	2" (50.8 mm)	0.20 lb (0.09 kg)



5204

Adjustable Web Tool Belt

- Accommodates tunnel loop and slotted tool pouches and holders
- 2" (51 mm) wide polypropylene webbing
- Rugged metal buckle for quick release and easy adjustment
- Corrosion resistant hardware
- Made in the USA with global components

Cat. No.	Waist Size	Overall Width	Weight
5225	32" to 48" (81.3 to 121.9 cm)	2" (50.8 mm)	0.60 lb (0.27 kg)



5225

Heavy-Duty Tool Belts

- Strong, heavy-duty leather construction
- Equipped with a double-tongue buckle (Cat. No. 5415 Series) or double-tongue buckle with keeper (Cat. No. 5420 Series)
- Separate reel-strap with its own buckle lets you quickly and conveniently put on or take off a Klein tie-wire reel (Cat. No. 5420 Series)
- Made in the USA with global components

Cat. No.	Waist Size	Overall Width	Weight
5415S	32" to 40" (81.3 to 101.6 cm)	2" (50.8 mm)	0.63 lb (0.29 kg)
5415	36" to 44" (91.4 to 111.8 cm)	2" (50.8 mm)	0.64 lb (0.29 kg)
5415L	40" to 48" (101.6 to 121.9 cm)	2" (50.8 mm)	0.64 lb (0.29 kg)
5415XL	44" to 52" (111.8 to 132.1 cm)	2" (50.8 mm)	0.65 lb (0.29 kg)
5420S	32" to 40" (81.3 to 101.6 cm)	2" (50.8 mm)	0.85 lb (0.39 kg)
5420	36" to 44" (91.4 to 111.8 cm)	2" (50.8 mm)	0.95 lb (0.43 kg)
5420L	40" to 48" (101.6 to 121.9 cm)	2" (50.8 mm)	1.1 lb (0.5 kg)
5420XL	44" to 52" (111.8 to 132.1 cm)	2" (50.8 mm)	1.2 lb (0.5 kg)



5415



5420L



Tool Belts

Padded Leather Quick-Release Belts

- Durable leather belt and pad provide comfort and safety
- Quick-release buckle allows user to immediately disengage the belt if needed
- Leather belt pad provides a comfortable cushion for the back
- One-way release snaps keep the pad in place
- Heavy-duty leather for long life
- Made in the USA with global components



5426M

Cat. No.	Waist Size	Overall Width	Weight
NEW 5426M	34" to 38" (86.4 cm to 96.5 cm)	5" (12.7 cm)	2.09 lb (0.94 kg)
NEW 5426L	38" to 46" (96.5 cm to 116.8 cm)	5" (12.7 cm)	2.10 lb (0.95 kg)
NEW 5426XL	46" to 54" (116.8 to 137.2 cm)	5" (12.7 cm)	2.15 lb (0.98 kg)

Cotton/Polyester Blend Tool Belt w/Quick-Release Buckle

- NOT an occupational protective belt. ONLY use as a tool belt
- Features a forged, quick-release buckle for emergency situations where the user has to quickly disengage the belt (for example, when working over water or in grain elevators)
- Must be worn over the user's harness and clothing so it will drop free when released
- Made of a mildew-resistant blend of cotton/polyester webbing for comfort and strength
- Made in the USA with global components



5425M

Cat. No.	Waist Size	Overall Width	Weight
5425M	30" to 44" (76.2 to 111.8 cm)	2" (50.8 mm)	1.5 lb (0.7 kg)
5425XL	38" to 58" (96.5 to 147.3 cm)	2" (50.8 mm)	1.7 lb (0.8 kg)

Designed for Quick Release

1. Pull free end of release strap to disengage other end from retainer.
2. Pulling action rotates clasp to open position.
3. Disengaged clasp allows belt to separate.

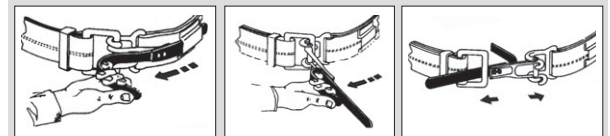

Suspenders & Belt Accessories

Suspenders

- Clips and slides are nickel-plated for corrosion resistance
- Extra-strong belt clips have alligator teeth for added gripping power
- Made in the USA with global components



60223B

Cat. No.	Description	Color	Size	Strap Width	Weight
60210B	Nylon-Web Suspenders with Adjustable Back	Blue	One Size Fits All	2" (50.8 mm)	0.63 lb (0.29 kg)
60223B	Elastic-Back Suspenders	Blue	One Size Fits All	2" (50.8 mm)	0.60 lb (0.27 kg)

Leather Cushion Belt Pads

- Durable, deluxe leather pad is comfortable to wear for long periods
- Thick leather back with four snap-open straps for easy attachment to any belt up to 2" (51 mm) wide
- Sponge-padded leather liner has rounded edges, and is permanently stitched to the back
- When sizing a belt to accommodate this pad, add 2" to 4" (51 to 102 mm) to the belt waist size
- Made in the USA with global components



87904

Cat. No.	Overall Length	Overall Width	Weight
87904	22" (558.8 mm)	4" (101.6 mm)	0.99 lb (0.45 kg)
87906	30" (762.0 mm)	4" (101.6 mm)	1.0 lb (0.5 kg)

See page 297 for additional information on warnings.

WARNING: This is NOT an occupational protective belt.

WARNING: NOT for fall arrest or back support.

Tool Bags and Storage

Tool bags from Klein come in a wide variety of shapes and sizes to match the diverse tools and accessories professionals use every day.



For Professionals...
Since 1857™

TRADESMAN PRO™ TOOL MASTER BACKPACK

Be ready for anything

REMOVABLE TOOL CADDY
with handles and D-Ring for hanging

Padded handle with reinforced aircraft cable

Metal hanging hook tucks easily away

Large interior space fits larger hand tools like drills

Durable back padding extends over the hard bottom for carrying comfort

Extra padding on the shoulder straps

**48
POCKETS**

Adjustable chest and lower straps for a customized fit

Molded front pocket protects safety glasses, phones, etc.

Hard molded plastic bottom protects from the elements

Tool Master Backpack

- 48 pockets to easily keep everything organized
- Removable tool caddy with carrying handles and a D-ring for hanging, a zipper pocket and closed pouches for small tools and parts, and open pockets and straps ideal for long drivers
- Aircraft cable heavily reinforces the handle as well as a heavy-duty zipper with lockable pulls
- Made of durable 1680d ballistic weave material and a molded bottom to help protect from the elements
- Hang the bag from the heavy-duty metal hook for easy access into the bag
- Well-padded shoulder straps have a buckled chest strap along with lower straps that adjust for a perfect fit
- Molded front pocket helps protect items like phones and safety glasses
- Orange interior helps find tools easily and a large interior space for larger hand tools

NEW
Product

PTIA 2018
TOOL INNOVATION AWARDS FINALIST

Cat. No.	Number of Pockets	Overall Length	Overall Height	Overall Width	Weight
NEW 55485	48	11" (279.4 mm)	19.5" (495.3 mm)	13.5" (342.9 mm)	13.2 lb (6.0 kg)



55485

TRADESMAN PRO™

Durable, versatile, functional and designed with the tradesperson in mind.

Most Tradesman Pro™ bags have these core features



1680d ballistic weave for durability

Multiple pockets sized specifically to fit all your tools for complete organization

Bright colored interior for easy tool visibility

Tough, durable molded bottoms to protect from the elements

Electrician's Backpacks

Includes core Tradesman Pro™ features plus:

- Wide opening fits power drills, meters, flashlights, etc.
- Large front pocket easily fits cables and tools
- Cat. No. 55597 has a polyester upper pocket and Cat. Nos. 55421BP-14 and 55421BP14CAMO have a hard molded pocket to protect safety glasses, meters, etc.
- Resized pockets to better fit tools
- Shoulder strap with extra padding
- Longer pockets for screwdrivers
- Cat. No. 55597 features reflective shoulder and front strips



Realtree AP-XTRA Camouflage Design
© 2012 of Jordan Outdoor Enterprises, Ltd., all rights reserved.

55421BP-14

55421BP14CAMO

55597

Cat. No.	Description	Number of Pockets	Overall Length	Overall Height	Overall Width	Weight
55421BP-14	Tradesman Pro™ Backpack	39	14.5" (368.3 mm)	20" (508.0 mm)	7.25" (184.2 mm)	6.0 lb (2.7 kg)
55421BP14CAMO	Tradesman Pro™ Camo Backpack	39	14.5" (368.3 mm)	20" (508.0 mm)	7.25" (184.2 mm)	6.0 lb (2.7 kg)
55597	Tradesman Pro™ High Visibility Backpack	39	14.375" (365.1 mm)	20" (508.0 mm)	7" (177.8 mm)	5.4 lb (2.5 kg)

* DOES NOT conform to ANSI/SEA 107-2015 high visibility safety apparel and accessories standard.



Backpacks & Tool Bags

TRADESMAN PRO™

Tool Gear Backpack

- Tall interior pockets for long screwdrivers
- Upper pocket holds cell phones, keys, etc.
- Zipper pocket has space for pencils and small items
- Bottom is constructed of a coated tough diamond-textured material
- Orange interior to find tools faster
- 1680d ballistic weave for durability



Cat. No.	Number of Pockets	Overall Length	Overall Height	Overall Width	Weight
55475	35	7.375" (187.3 mm)	17.5" (444.5 mm)	14.5" (368.3 mm)	4.4 lb (2.0 kg)

55475

Tech Backpack

Includes core Tradesman Pro™ features plus:

- Storage for adapters and cables
- Organizer pocket for pens, phone, cables, and more
- Hard, molded front pocket protects safety glasses
- Cat. No. 55439BPTB fits laptop up to 3" (76 mm) thick



Separate compartment keeps laptop protected from other tools.



Cat. No.	Number of Pockets	Overall Length	Overall Height	Overall Width	Weight
55456BPL	25	14" (355.6 mm)	18.5" (469.9 mm)	7" (177.8 mm)	6.0 lb (2.7 kg)
55439BPTB	25	14" (355.6 mm)	18.5" (469.9 mm)	7" (177.8 mm)	5.4 lb (2.5 kg)

55456BPL

Tech Bag

Includes core Tradesman Pro™ features plus:

- Inside pocket for adapters and cables
- Zipper pocket for files and paperwork
- Rubber feet and water resistant material on bottom protects from the elements



Separate compartment keeps laptop protected from other tools.



Cat. No.	Number of Pockets	Overall Length	Overall Height	Overall Width	Weight
55455M	22	19" (482.6 mm)	16" (406.4 mm)	6.5" (165.1 mm)	4.6 lb (2.1 kg)

55455M

TRADESMAN PRO™ Tool Bags

Wide-Open Tool Bag

Includes core Tradesman Pro™ features plus:

- Stay-open top for unobstructed tool access
- Large interior zipper pocket
- Inside is equipped with various sized pockets for tools and gear
- Multiple exterior front and back pockets for quick access
- Outside has side mesh pockets and a metal tape measure holder
- Shoulder strap with extra padding and handles



Cat. No.	Number of Pockets	Overall Length	Overall Height	Overall Width	Weight
55469	42	10.25" (260.4 mm)	16.25" (412.8 mm)	17.75" (450.9 mm)	8.0 lb (3.6 kg)

55469

Lighted Tool Bag

Includes core Tradesman Pro™ features plus:

- Included removable LED light can be twist on / twist off so light can be positioned to illuminate inside the bag or the outside workspace

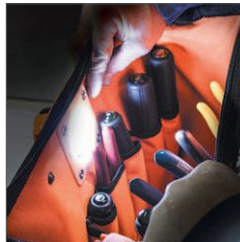

See **55437 Work Light** in Illumination section for additional information or to order a replacement light.



Cat. No.	Number of Pockets	Overall Length	Overall Height	Overall Width	Weight
55431	31	15.25" (387.4 mm)	14" (355.6 mm)	8" (203.2 mm)	5.0 lb (2.3 kg)

55431

High-Visibility Tool Bag

Includes core Tradesman Pro™ features plus:

- Stay-open top
- Large interior zipper pocket
- Tall interior pockets for long screwdrivers
- Shoulder strap with extra padding and handles
- Front pockets hold tools or small parts
- Mesh side pockets
- Reflective outer strips for visibility in low-light environments



Cat. No.	Number of Pockets	Overall Length	Overall Height	Overall Width	Weight
55598	42	17.5" (444.5 mm)	16" (406.4 mm)	10" (254.0 mm)	7.0 lb (3.2 kg)

55598

*DOES NOT conform to ANSI/SEA 107-2015 high visibility safety apparel and accessories standard.



Tool Bags & Totes

TRADESMAN PRO™

Rolling Tool Bag

Includes core Tradesman Pro™ features plus:

- Rugged 6-inch wheels easily handle rough terrain
- Load tested up to 200 lbs.
- Top has reinforced metal frame that stays open for easy loading/unloading
- Heavy-duty telescoping handle
- Withstands cold conditions



Molded kick plate to protect from the elements.



Wide open interior to accommodate large tools.

Cat. No.	Number of Pockets	Overall Length	Overall Height	Overall Width	Weight
55452RTB	24	19" (482.6 mm)	14" (355.6 mm)	12.5" (317.5 mm)	19.0 lb (8.6 kg)



55452RTB

10-Inch Tote

Includes core Tradesman Pro™ features plus:

- Double stitched seams for extra durability
- Resized pockets to better fit tools
- Large zipper pockets for tools and small parts
- Shoulder strap with extra padding
- Longer pockets for screwdrivers



Cat. No.	Number of Pockets	Overall Length	Overall Height	Overall Width	Weight
5541610-14	40	10" (254.0 mm)	12.25" (311.2 mm)	10.25" (260.4 mm)	6.0 lb (2.7 kg)



5541610-14

8-Inch Tote

Includes core Tradesman Pro™ features plus:

- Double stitched seams for extra durability
- Resized pockets to better fit tools
- Large zipper pockets for tools and small parts
- Shoulder strap with extra padding
- Longer pockets for screwdrivers



Cat. No.	Number of Pockets	Overall Length	Overall Height	Overall Width	Weight
554158-14	20	8.75" (222.3 mm)	17" (431.8 mm)	8.75" (222.3 mm)	5.0 lb (2.3 kg)



554158-14

TRADESMAN PRO™ Pouches & Bags

Shoulder Pouch

Includes core Tradesman Pro™ features plus:

- Double stitched seams for extra durability
- Resized pockets to better fit tools
- Shoulder strap with extra padding
- Longer pockets for screwdrivers



55419SP-14

Cat. No.	Number of Pockets	Overall Length	Overall Height	Overall Width	Weight
55419SP-14	14	8" (203.2 mm)	10" (254.0 mm)	5" (127.0 mm)	3.0 lb (1.4 kg)

Bucket Bag

- Double layer of polyester at bucket edges for durability
- Interior pockets include: three tool sleeves, one power tool/cord sleeve, and six universal pockets
- Exterior pockets include: nine screwdriver/nut driver pockets, eleven pliers pockets, eleven utility pockets, two wire stripper pockets, and two Velcro® closeable pockets
- Heavy-duty webbing keeps pockets open for easy access to supplies and tools



55448

Cat. No.	Number of Pockets	Diameter	Weight
55448	45	19" (482.6 mm)	2.0 lb (0.9 kg)

VELCRO® is a registered trademark of Velcro Industries B.V. Tools and bucket not included.

Attachable Hacksaw Holder

- Quick link for attaching to tool bags
- Fits standard hacksaws up to 16.5"
- Protective plastic lined interior
- Top-loading for easy access to hacksaw
- Web strap with snap closure keeps hacksaw secure

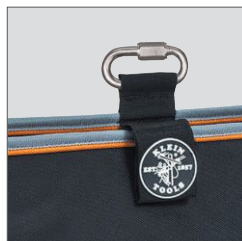

55454DHB

Cat. No.	Number of Pockets	Overall Length	Overall Height	Overall Width	Weight
55454DHB	1	17" (431.8 mm)	8.375" (212.7 mm)	1.5" (38.1 mm)	1.3 lb (0.6 kg)



Tool Bags

Cordura® Ballistic Nylon Tool Bag

- Cordura® ballistic nylon, a high-performance fabric resistant to abrasions, tears and scuffs
- Molded bottom made with a durable, impact modified polypropylene
- Eight interior and two exterior pockets hold a wide assortment of hand tools and supplies
- Large opening with reinforced steel frame maintains the bag's shape while loading and unloading
- Heavy-duty nylon zipper closure and a large leather zipper-pull assure easy operation
- Box-stitched 2" (51 mm) wide polypropylene padded carrying handles with comfortable leather wrap
- Optional padded, slip-resistant adjustable shoulder strap (Cat. No. 58889) for hands-free mobility is available
- Made in USA with global components



5200-15

Cat. No.	Overall Length	Overall Height	Overall Width	Weight
5200-15	15" (381.0 mm)	14.5" (368.3 mm)	8" (203.2 mm)	3.5 lb (1.6 kg)

Cordura® is a registered trademark of INVISTA for durable fabrics.

Canvas Tool Bags

- Heavy-duty No. 8 natural canvas
- Rivet-reinforced for durability
- Steel-frame mouth with hinge for rugged use
- Stitched and riveted leather handles for comfort and strength
- Two retaining straps with buckles provide secure closure
- Bottom and lower sides are covered with moisture-resistant vinyl
- Non-scratch studs on base protect against wear
- Should strap kit available (Cat. No. 5102S)
- Made in USA with global components



5102-12

Cat. No.	Overall Length	Overall Height	Overall Width	Weight
5102-12	12" (304.8 mm)	10" (254.0 mm)	6" (152.4 mm)	2.0 lb (0.9 kg)
5102-14	14" (355.6 mm)	14" (355.6 mm)	6" (152.4 mm)	2.5 lb (1.1 kg)
5102-16	16" (406.4 mm)	14" (355.6 mm)	6" (152.4 mm)	3.0 lb (1.4 kg)
5102-18	18" (457.2 mm)	14" (355.6 mm)	6" (152.4 mm)	2.8 lb (1.3 kg)
5102-20	20" (508.0 mm)	15" (381.0 mm)	6" (152.4 mm)	3.0 lb (1.4 kg)
5102-22	22" (559 mm)	15" (381.0 mm)	6" (152.4 mm)	3.0 lb (1.4 kg)
5102-24	24" (609.6 mm)	15" (381.0 mm)	6" (152.4 mm)	4.0 lb (1.8 kg)

Deluxe Canvas Tool Bags

- Multiple interior pockets for organization
- Detachable shoulder strap can be adjusted for a perfect fit
- Made of heavy-duty No. 8 natural canvas
- Moisture-resistant vinyl bottom with non-scratch studs on the base to protect against wear
- Steel frame mouth with hinge for rugged use
- Stitched and riveted leather handles for long life
- Made in USA with global components



5102-16SP

Cat. No.	Number of Pockets	Overall Length	Overall Height	Overall Width	Weight
5102-14SP	10	14" (355.6 mm)	10" (254.0 mm)	6" (152.4 mm)	3.5 lb (1.6 kg)
5102-16SP	13	16" (406.4 mm)	14" (355.6 mm)	6" (152.4 mm)	3.7 lb (1.7 kg)
5102-18SP	13	18" (457.2 mm)	14" (355.6 mm)	6" (152.4 mm)	4.0 lb (1.8 kg)
5102-24SP	17	24" (609.6 mm)	15" (381.0 mm)	6" (152.4 mm)	5.0 lb (2.3 kg)

Tool Bags

High-Bottom Canvas Tool Bags

- Heavy-duty No. 8 natural canvas
- Bottom and 8" (203 mm) of lower sides are covered with moisture-resistant vinyl
- Non-scratch studs on base protect against wear
- Steel-frame mouth with hinge for rugged use
- Harness-leather handles with two retaining straps and buckles
- Retro-fit bags with shoulder strap kit (Cat. No. 5102S). Kit includes leather strap with pad and snap hooks, rings and fasteners for attaching rings to bags
- Made in USA with global components

Cat. No.	Overall Length	Overall Height	Overall Width	Weight
5105-20	20" (508.0 mm)	15" (381.0 mm)	6" (152.4 mm)	3.5 lb (1.6 kg)
5105-24	24" (609.6 mm)	15" (381.0 mm)	6" (152.4 mm)	4.0 lb (1.8 kg)



5105-20

Canvas Tool Bags - Multiple Pockets, Leather Bottom

- Steel-frame mouth with hinge for rugged use
- Internal pockets in a variety of sizes
- External pocket for additional carrying needs
- Constructed of strong No. 8 natural canvas
- Reinforced bottom supports heavy tools, blocks moisture, and provides durability at wear points
- Wide opening provides easy access to large tools
- Bottom is protected from the elements by 6 studs
- Includes: Shoulder strap mounts (optional shoulder strap available, Cat. No. 58889), leather bottom and 3" (76 mm) of sides covered with black leather, 2" (51 mm) wide web handles, leather handle wrap, and external tool loop handle in the webbing
- Made in USA with global components

Cat. No.	Number of Pockets	Overall Length	Overall Height	Overall Width	Weight
5003-18	11	18" (457.2 mm)	14" (355.6 mm)	6" (152.4 mm)	4.0 lb (1.8 kg)
5003-20	15	20" (508.0 mm)	15" (381.0 mm)	6" (152.4 mm)	4.0 lb (1.8 kg)



5003-18

Canvas Tool Bags

- Heavy-duty No. 6 natural canvas
- Double-layer canvas bottom
- Reinforced, riveted web handles
- Made in USA with global components

Cat. No.	Overall Length	Overall Height	Overall Width	Weight
5155	17" (431.8 mm)	12" (304.8 mm)	9" (228.6 mm)	1.5 lb (0.7 kg)
5156	19" (482.6 mm)	15" (381.0 mm)	9" (228.6 mm)	1.9 lb (0.9 kg)



5155



Tool Bags

Lineman's Duffel Bag

- Bright orange for easy visibility
- Water-resistant vinyl protects against the elements
- Drain holes help minimize water build up
- Mesh strips keep bag aerated so clothes and equipment can dry
- Web straps extend around the bag for extra support
- Handles are large enough to carry bag like a backpack
- Made in the USA of global components



5216V

Cat. No.	Overall Length	Overall Height	Overall Width	Weight
NEW 5216V	24" (609.6 mm)	12" (304.8 mm)	12" (304.8 mm)	2 lb (0.9 kg)

Vinyl Equipment Bags

- Wide bag opening easily accommodates helmets and other equipment
- Two large, outside pockets with Velcro® fastening (Cat. No. 5182BLA)
- Durable, double-stitched plastic bottom; Cat. No. 5180 is reinforced with 1/4" (6 mm) plywood
- Webbing extends down side of bag from handles and shoulder strap for extra support and durability (Cat. Nos. 5182BLA and 5181ORA)
- Wide opening steel frame is securely riveted in top of bag (Cat. No. 5180)
- Right-sized rain flap with Velcro® fastening
- Adjustable, padded shoulder strap included (Cat. Nos. 5182BLA and 5181ORA)
- Made in USA with global components



5180



5182BLA

5181ORA

Cat. No.	Number of Pockets	Overall Length	Overall Height	Overall Width	Weight
5182BLA	2	24" (609.6 mm)	20" (508.0 mm)	10" (254.0 mm)	7.0 lb (3.2 kg)
5181ORA	1	24" (609.6 mm)	20" (508.0 mm)	10" (254.0 mm)	7.0 lb (3.2 kg)
5180	0	24" (609.6 mm)	18" (457.2 mm)	10" (254.0 mm)	6.0 lb (2.7 kg)

VELCRO® is a registered trademark of Velcro Industries B.V.

Tool Bags

Lineman's Backpack

- Wide opening easily accommodates helmets, belts, and other equipment
- Large front pocket for separate storage of gaffs, rubber gloves, or other equipment
- Durable, double stitched plastic bottom with drain holes
- Rain flap for top of pack
- Adjustable padded shoulder straps with adjustable waist strap
- Padded back area
- Made in USA with global components



51850RA

Cat. No.	Number of Pockets	Overall Length	Overall Height	Overall Width	Weight
51850RA	4	18" (457.2 mm)	23" (584.2 mm)	10" (254.0 mm)	5.0 lb (2.3 kg)

Tool Totes

- Constructed of rugged, 600 x 300 denier polyester to resist wear and tear on the jobsite
- 2" (51 mm) wide polypropylene padded carrying handles with comfortable leather wrap
- Water-resistant to avoid the build-up of mold and mildew
- Exterior pockets hold a variety of tools and a mobile phone
- Multiple interior pockets and a large interior compartment for a wide assortment of tools and supplies (only with Cat. No. 58888 and Cat. No. 58890)
- Durable molded bottom with drain holes to prevent water retention
- Contoured, padded, slip-resistant shoulder strap for hands-free mobility (included with Cat No. 58888 and Cat. No. 58890)
- Heavy-duty chain tape thong (Cat. No. 58890 only)
- Made in USA with global components



58890

Cat. No.	Number of Pockets	Chain Tape Thong	Shoulder Strap	Overall Length	Overall Height	Overall Width	Weight
58886	7	No	No	15.5" (393.7 mm)	10" (254.0 mm)	7.5" (190.5 mm)	2.5 lb (1.1 kg)
58888	12	No	Yes	15.5" (393.7 mm)	10" (254.0 mm)	7.5" (190.5 mm)	3.0 lb (1.4 kg)
58890	17	Yes	Yes	15.5" (393.7 mm)	10" (254.0 mm)	7.5" (190.5 mm)	3.0 lb (1.4 kg)

*Optional shoulder strap (Cat. No. 58889) available.

Ten-Compartment Drawstring Bag

- 12 oz. olive canvas
- Ten compartments to hold small parts
- Drawstring for easy closing
- Made in USA with global components



5151

Cat. No.	Overall Height	Diameter	Weight
5151	6" (152.4 mm)	11" (279.4 mm)	0.40 lb (0.18 kg)



Tool Bags

Leather Tote Bag

- Rugged tool bag made of extra-heavy leather
- Stitched and riveted construction
- Reinforced ends
- Double-ply bottom with steel studs
- Made in USA with global components



5115

Cat. No.	Overall Length	Overall Height	Overall Width	Weight
5115	15" (381.0 mm)	7" (177.8 mm)	6.5" (165.1 mm)	2.0 lb (0.9 kg)

Deluxe Leather Bags

- Rugged tool bag made of extra-heavy leather
- Removable padded shoulder strap
- Three-ply bottom with steel studs
- Retaining straps extend around bag for extra support
- Made in USA with global components



5108-18

Cat. No.	Overall Length	Overall Height	Overall Width	Weight
5108-18	18" (457.2 mm)	8" (203.2 mm)	7" (177.8 mm)	4.6 lb (2.1 kg)
5108-20	20" (508.0 mm)	8" (203.2 mm)	7" (177.8 mm)	5.0 lb (2.3 kg)
5108-24	24" (609.6 mm)	8" (203.2 mm)	7" (177.8 mm)	5.0 lb (2.3 kg)

Zipper Bags

TRADESMAN PRO™

Tradesman Pro™ Zipper Bags

- Includes 2 zipper bags: 12-1/2"x 7" (317.5 x 177.8 mm) and 10" x 5-1/2" (254.0 x 139.7 mm)
- Handy storage for pliers, wrenches, screwdrivers and other small tools and parts
- Black aluminum carabiner included (not for human support)
- Cat. No. 55599 features high-visibility interiors and reflective outer strips



55560



55599



Realtree AP-XTRA Camouflage Design
© 2012 of Jordan Outdoor Enterprises, Ltd., all rights reserved.

Cat. No.	Material	Color	Overall Height	Overall Width	Weight
55599	1680d Ballistic Weave	Black, Reflective Gray, Green Accents	7" (177.8 mm), 5.5" (139.7 mm)	12.5" (317.5 mm), 10" (254 mm)	0.39 lb (0.18 kg)
55560	1680d Ballistic Weave	Camouflage	7" (177.8 mm), 5.5" (139.7 mm)	12.5" (317.5 mm), 10" (254 mm)	0.39 lb (0.18 kg)

DOES NOT conform to ANSI/ISEA 107-2015 high visibility safety apparel and accessories standard.

Zipper Bags

Stand-up Zipper Bags

- Reinforced bottom of 2520d ballistic material prevents tools and parts from poking through
- Stand-up bottom allows items to be found more easily
- Colored interior to see items better
- Bags are different sizes and colors to help with organization
- Body of the bags are of tough 1680d ballistic material
- Connect bags with a carabiner (not for human support)
- Two-pack includes a 6-1/2" tall (165 mm) orange bag and a 7-1/2" tall (191 mm) gray bag



55470

Cat. No.	Material	Color	Overall Length	Overall Height	Overall Width	Weight
55470	1680d Ballistic Nylon, 2520d Ballistic Nylon Bottom	Orange/Black; Gray/Black	8.5" (215.9 mm); 9" (228.6 mm)	6.5" (165.1 mm); 7.5" (190.5 mm)	1.125" (28.6 mm)	6.6 oz (186 g)

Canvas Zipper Bags

- Heavy-duty brass zipper
- Convenient storage for wire nuts, connectors and other consumables
- 3-1/2" (89 mm) wide bottom for stability when standing; easy access when open
- Brass grommet for hanging or attaching to belt or clip
- Made in USA with global components



5539BLU

Cat. No.	Material	Color	Overall Length	Overall Height	Overall Width	Weight
5539RED	No. 8 Canvas	Red	10" (254.0 mm)	8" (203.2 mm)	3.5" (88.9 mm)	3.8 oz (109 g)
5539BLU	No. 8 Canvas	Blue	10" (254.0 mm)	8" (203.2 mm)	3.5" (88.9 mm)	3.8 oz (109 g)
5539YEL	No. 8 Canvas	Yellow	10" (254.0 mm)	8" (203.2 mm)	3.5" (88.9 mm)	3.8 oz (109 g)
5539NAT	No. 8 Canvas	Natural	10" (254.0 mm)	8" (203.2 mm)	3.5" (88.9 mm)	3.8 oz (109 g)
5539CPAK	No. 8 Canvas	3-Pack; Red, Blue, Yellow	10" (254.0 mm)	8" (203.2 mm)	3.5" (88.9 mm)	12.3 oz (350 g)

US Patents: D621153, D625515, D625915

Contractor's Zipper Portfolios

- Great for transporting contracts, quotations, work orders, plans, and schedules
- Holds clipboards, binders, and mobile phones
- Convenient storage for pliers, wrenches, screwdrivers, nut drivers, other tools, and spare parts
- Cat. No. 5236 has a heavy duty nylon zipper
- Cat. Nos. 5136 and 5336 have heavy duty brass zippers
- Made in USA with global components



5136

Cat. No.	Material	Color	Overall Length	Overall Height	Overall Width	Weight
5136	Top Grain Leather	Brown	17" (431.8 mm)	12" (304.8 mm)	0.7" (18 mm)	13.4 oz (381 g)
5236	Cordura® Ballistic Nylon	Black	17" (431.8 mm)	12" (304.8 mm)	0.5" (12.7 mm)	8.2 oz (231 g)
5336	No. 10 Canvas	Natural	17" (431.8 mm)	12" (304.8 mm)	0.7" (18 mm)	6.4 oz (181 g)

Cordura® is a registered trademark of INVISTA for durable fabrics.



Zipper Bags

Canvas Zipper Bags - 4 Pack

- Includes four assorted colors to organize and categorize important tools
- Heavy-duty brass zipper
- Convenient storage for pliers, wrenches, screwdrivers, nut drivers, other tools, and spare parts
- Made in USA with global components



5140



5141

Cat. No.	Material	Color	Overall Length	Overall Height	Overall Width	Weight
5140	No. 10 Canvas	Olive, Orange, Blue, Yellow	12.5" (317.5 mm)	7" (177.8 mm)	0.7" (18 mm)	15 oz (426 g)
5141	No. 10 Canvas	Red, Gray, Black, Brown	12.5" (317.5 mm)	7" (177.8 mm)	0.7" (18 mm)	15 oz (426 g)

Zipper Bags



5139



5139B



5139C



5139L

- Constructed of No. 10 canvas with heavy-duty brass zipper (Cat. No. 5139)
- Convenient storage for pliers, wrenches, screwdrivers, nut drivers, other tools, and spare parts
- Constructed of Cordura® ballistic nylon, a high-performance fabric resistant to abrasions, tears, and scuffs (Cat. Nos. 5139B, 5139C)
- Cat. No. 5139C features the jungle stalker digitized camouflage pattern for maximum concealment
- Heavy-duty nylon stitching and zipper ensure durability and long life (Cat. Nos. 5139B, 5139C)
- Heavy-duty nylon zipper. (Cat. Nos. 5139B, 5139C)
- Made in USA with global components

Cat. No.	Material	Color	Overall Length	Overall Height	Overall Width	Weight
5139	No. 10 Canvas with Brass Zipper	Natural	12.5" (317.5 mm)	7" (177.8 mm)	0.7" (18 mm)	3.0 oz (86 g)
5139B	Cordura® Ballistic Nylon	Black	12.5" (317.5 mm)	7" (177.8 mm)	0.5" (12.7 mm)	3.8 oz (109 g)
5139C	Cordura® Camouflage	Camouflage	12.5" (317.5 mm)	7" (177.8 mm)	0.5" (12.7 mm)	2.2 oz (64 g)
5139L	Top Grain Leather	Brown	12.5" (317.5 mm)	7" (177.8 mm)	0.7" (18 mm)	3.7 oz (104 g)

Cordura® is a registered trademark of INVISTA for durable fabrics.

Padded Cordura® Zipper Bag

- Constructed of Cordura® washable fabric, a high performance fabric resistant to abrasions, tears and scuffs
- Three-layer padding provides additional protection to contents
- Heavy-duty nylon zipper
- Made in USA with global components



5139PAD

Cat. No.	Material	Color	Overall Length	Overall Height	Overall Width	Weight
5139PAD	Cordura® Ballistic Nylon	Black	12.5" (317.5 mm)	7" (177.8 mm)	0.5" (12.7 mm)	4.5 oz (127 g)

Cordura® is a registered trademark of INVISTA for durable fabrics.

Glove Bags

Canvas Glove Bags

- Made of durable canvas
- Has an expansion gusset, 5-1/2" (140 mm) across the top and 2-3/4" (70 mm) at bottom
- Brass grommets in bottom for ventilation
- Supplied with two-way snap
- Includes safety notice to remind workers of the importance of using gloves
- Made in USA with global components

Cat. No.	Material	Overall Length	Overall Width	Top Depth	Bottom Depth	Weight
5121-15	No. 4 Canvas	15" (381.0 mm)	8" (203.2 mm)	5.5" (139.7 mm)	2.75" (69.9 mm)	0.75 lb (0.34 kg)
5121-19	No. 4 Canvas	19" (482.6 mm)	8" (203.2 mm)	5.5" (139.7 mm)	2.75" (69.9 mm)	0.75 lb (0.34 kg)
5124-15	No. 10 Canvas	15" (381.0 mm)	8" (203.2 mm)	4" (101.6 mm)	4" (101.6 mm)	0.60 lb (0.27 kg)
5124-17	No. 10 Canvas	17" (431.8 mm)	8" (203.2 mm)	4" (101.6 mm)	4" (101.6 mm)	0.60 lb (0.27 kg)
5124-19	No. 10 Canvas	19" (482.6 mm)	8" (203.2 mm)	4" (101.6 mm)	4" (101.6 mm)	0.75 lb (0.34 kg)



5121-15

Combination Glove and Sleeve Bags

- Panels are tough No. 4 canvas
- Provides separate storage for gloves and sleeves
- Brass grommets in bottom for ventilation
- Supplied with two-way snap
- Includes safety notice to remind workers of the importance of using gloves
- Made in USA with global components

Cat. No.	Material	Overall Length	Overall Width	Top Depth	Bottom Depth	Weight
5122-16	No. 4 Canvas	16" (406.4 mm)	8" (203.2 mm)	4.813" (122.3 mm)	4.813" (122.3 mm)	1.0 lb (0.5 kg)
5122-18	No. 4 Canvas	18" (457.2 mm)	8" (203.2 mm)	4.813" (122.3 mm)	4.813" (122.3 mm)	1.0 lb (0.5 kg)



5122-16

Tool Bag Accessories

Adjustable Shoulder Strap Kit

- Works with Cat. Nos. 5102 and 5105 series canvas tool bags
- Adjustable strap is 1" (25 mm) wide with a 2-1/2" (64 mm) shoulder pad
- Complete kit contains leather strap with pad and snap hooks, rings and fasteners for attaching rings to bags
- Made in USA with global components

Cat. No.	Adjustable Length	Weight
5102S	46 to 57.5" (1168.4 to 1460.5 mm)	0.75 lb (0.34 kg)



5102S

Padded Adjustable Shoulder Strap

- Shoulder strap for Tool Tote™ and 5003 series canvas tool bags
- Adjustable from both ends for a perfect fit
- Strap is 2" (51 mm) wide with a 3" (76 mm) soft shoulder pad
- Made in USA with global components

Cat. No.	Adjustable Length	Weight
58889	37" to 55" (940 to 1397 mm)	0.35 lb (0.16 kg)



58889



Slide Racks

Slide Racks

- Holds Klein mid-size or extra-large storage boxes
- Boxes not included with rack; must be ordered separately
- Welded, extra-rigid, all-steel construction
- Metallic gray baked-enamel finish
- Boxes ride in and out on heavy-duty channel tracks that permit covers to open all the way for full access
- Heavy tabs prevent boxes from being accidentally pulled out, yet allow boxes to be easily removed when desired
- Locking bars can be readily attached to prevent unauthorized access
- Made in USA

Cat. No.	Overall Length	Overall Height	Overall Width	Holds	Weight
54474	11.875" (301.6 mm)	11.313" (287.4 mm)	15.188" (385.8 mm)	Four Klein Mid-Size Storage Boxes	20.0 lb (9.1 kg)
54476	11.75" (298.5 mm)	16.375" (415.9 mm)	15.25" (387.4 mm)	Six Klein Mid-Size Storage Boxes	30.0 lb (13.6 kg)
54477	15.75" (400.1 mm)	15" (381.0 mm)	20" (508.0 mm)	Four Klein Extra-Large Storage Boxes	37.0 lb (16.8 kg)



54474

Slide Rack Locking Bars

- Steel bars lock to secure mid-size storage boxes in slide racks
- Front hasp pivots down to allow locking bar to open
- Available for Klein four-box and six-box racks
- Strong piano hinge
- Metallic gray baked enamel finish
- Mounting holes allow for easy installation with sheet metal screws or pop rivets
- Made in USA



54484

Cat. No.	Description	Weight
54484	Slide Rack Locking Bars for 54474	0.25 lb (0.11 kg)
54486	Slide Rack Locking Bars for 54476/54477	0.35 lb (0.16 kg)

Tool Boxes

Adjustable Compartment Parts Box

- Movable dividers in this parts box allow compartment sections to be arranged and sized as desired
- Three partitions, running from front to back, divide the box into four equal 4-1/2" (114 mm) x 12" (305 mm) sections
- Nine straight metal dividers can be positioned anywhere between the partitions, in one inch (25 mm) increments, to create the compartments desired
- Boxes feature strong, rigid, heavy-duty welded construction
- Full-length piano hinged covers are designed to stay open for ease of access
- Each box has a carrying handle, positive pull-down locking catch
- Boxes are a heavy metallic gray baked-enamel finish
- Box compartments feature high-impact styrene construction
- Scoop-bottom design for easy parts removal and cleaning
- Fits four drawer extra-large slide rack Cat. No. 54477
- Made in USA

Cat. No.	Overall Length	Overall Height	Overall Width	Number of Compartments	Compartment Sizes	Weight
54451	12" (304.8 mm)	3" (76.2 mm)	18" (457.2 mm)	Adjustable	Adjustable	7.0 lb (3.2 kg)



54451

Tool Boxes

Mid-Size Compartment Boxes

- Klein storage boxes are offered with a choice of compartment sizes and arrangements
- Boxes feature strong, rigid, heavy-duty welded construction
- Full-length piano hinged covers are designed to stay open for ease of access
- Each box has a carrying handle, positive pull-down locking catch
- Boxes have a heavy, metallic gray baked-enamel finish
- Box compartments feature high-impact styrene construction
- Scoop-bottom design for easy parts removal and cleaning
- Fits either four-drawer slide rack Cat. No. 54474 or six-drawer rack Cat. No. 54476
- Made in USA



54438

Cat. No.	Overall Length	Overall Height	Overall Width	Number of Compartments	Compartment Sizes	Weight
54436	9.75" (247.7 mm)	2" (50.8 mm)	13.313" (338.2 mm)	8	6-7/16" x 2-1/16" (163.5 x 52.4 mm)	3.7 lb (1.7 kg)
54437	9.75" (247.7 mm)	2" (50.8 mm)	13.313" (338.2 mm)	12	4-5/16" x 2-5/16" (109.5 x 58.7 mm)	4.0 lb (1.8 kg)
54438	9.75" (247.7 mm)	2" (50.8 mm)	13.313" (338.2 mm)	16	3-1/4" x 2-5/16" (82.6 x 58.7 mm)	4.0 lb (1.8 kg)
54439	9.75" (247.7 mm)	2" (50.8 mm)	13.313" (338.2 mm)	20	2-5/8" x 2-5/16" (66.7 x 58.7 mm)	4.5 lb (2.0 kg)
54440	9.75" (247.7 mm)	2" (50.8 mm)	13.313" (338.2 mm)	21	20 Each 2-1/16" x 2-5/16" (52.4 x 58.7 mm) and One 2-3/4" x 9-1/16" (69.9 x 230.2 mm)	4.0 lb (1.8 kg)

Extra-Large Compartment Boxes

- Klein storage boxes are offered with a choice of compartment sizes and arrangements
- Boxes feature strong, rigid, heavy-duty welded construction
- Full-length piano hinged covers are designed to stay open for ease of access
- Each box has a carrying handle, positive pull-down locking catch
- Boxes have a heavy, metallic gray baked-enamel finish
- Box compartments feature high-impact styrene construction
- Scoop-bottom design for easy parts removal and cleaning
- Fits four-drawer extra-large slide rack Cat. No. 54477
- Made in USA



54445

Cat. No.	Overall Length	Overall Height	Overall Width	Number of Compartments	Compartment Sizes	Weight
54445	12" (304.8 mm)	3" (76.2 mm)	18" (457.2 mm)	16	4-3/8" x 2-7/8" (111.1 x 73.0 mm)	7.0 lb (3.2 kg)
54446	12" (304.8 mm)	3" (76.2 mm)	18" (457.2 mm)	21	20 Each 2-3/4" (69.9 mm) x 2-7/8" (73.0 mm) and One 3-3/4" (95.3 mm) x 11-7/8" (301.6 mm)	7.0 lb (3.2 kg)
54447	12" (304.8 mm)	3" (76.2 mm)	18" (457.2 mm)	24	20 Each 2-3/4" (69.9 mm) x 2-7/8" (73.0 mm) and Four 3-3/4" (95.3 mm) x 2-7/8" (73.0 mm)	8.0 lb (3.6 kg)
54448	12" (304.8 mm)	3" (76.2 mm)	18" (457.2 mm)	32	32 Each 2-1/8" x 2-7/8" (54.0 x 73.0 mm)	8.0 lb (3.6 kg)



Tool Kits

Some projects are more complex than others and require a variety of tools to be used. For this reason, Klein has tool kits to assist professionals with these demanding projects.

For Professionals...
Since 1857™

41-Piece Tool Kit

Cat. No.	Kit Contains	Weight
80141		29.8 lb (13.5 kg)



80141

⚠ WARNING: Blades are intended for cutting only, and should be handled and disposed of with care. Bending the blade can cause it to break, possibly resulting in bodily injury. Check local laws on legality of selling or possessing these knives.

⚠ WARNING: Do NOT open the tape measure case. Spring motor is under tension, and opening may cause injury.

⚠ WARNING: Never remove screws while fish tape is coiled inside reel.

Cat. No.	Description
BLK12	L Style Ball End Hex Key Caddy Set 12-Piece
J203-6	Long Nose Side Cutting Pliers, 6-3/4"
J203-8N	Journeyman™ Long Nose Pliers Side Cutting, 8"
J502-10	Journeyman™ Pump Pliers, 10"
D507-8	Adjustable Wrench, Extra Capacity 8"
D507-12	Adjustable Wrench Extra Capacity, 12"
600-1	5/16" Cabinet Tip Screwdriver 1-1/2"
600-4	1/4" Screwdriver Heavy Duty Square Shank
601-3	3/16" Cabinet Tip Screwdriver 3"
601-6	3/16" Cabinet Tip Screwdriver 6"
602-6	5/16" Keystone Tip Screwdriver, 6" Length
603-1	Stubby Screwdriver, #2 Phillips, 1-1/2" Shank
603-3	#1 Phillips Screwdriver, 3" Round Shank
603-4B	#2 Wire Bending Phillips Screwdriver
605-6	1/4" Cabinet Tip Screwdriver, Heavy Duty, 6"
630-3/16	3/16" Nut Driver with 3" Hollow Shaft
630-1/4	1/4" Nut Driver 3" Shaft Cushion Grip
630-5/16	5/16" Nut Driver Cushion-Grip 3" Shaft
630-11/32	11/32" Nut Driver 3" Hollow Shaft
630-3/8	3/8" Nut Driver with 3" Hollow Shaft
630-7/16	7/16" Hollow Nut Driver, 3", Cushion-Grip
630-1/2	1/2" Nut Driver, 3" Shaft, Cushion-Grip
650	Cushion-Grip Scratch Awl
662	#2 Square Screwdriver with 4" Round Shank
670-6	Screwdriver, 3/16" Cabinet, Rapi-Driv®, 6"
86225	Double Hook Magnetic Tape Measure, 25-Foot
935R	Aluminum Torpedo Level Rare Earth Magnet
J1005	Journeyman™ Crimping/Cutting Tool
K1412	Klein-Kurve® Dual NM Cable Stripper/Cutter
J2000-9NETP	9" Journeyman™ Wire Pulling Pliers Heavy Duty Side Cutting
J2000-48	8" Diagonal HD Cutting Pliers Angled Head
5003-18	Tool Bag, Canvas with Leather Bottom, 18"
5139	Canvas Zipper Bag
11055	Solid and Stranded Copper Wire Stripper and Cutter
44133	Klein-Kurve® Retractable Utility Knife
46037	Cable Splicer's Kit
56003	1/8" Wide Steel Fish Tape 125 ft
58889	Padded Adjustable Shoulder Strap
60053	Protective Eyewear, Black Frame, Clear Lens
J63050	Journeyman™ High Leverage Cable Cutter
85191	Conduit-Fitting and Reaming Screwdriver





28-Piece Tool Kit



Cat. No.	Kit Contains	Weight
80028		17.2 lb (7.8 kg)

Cat. No.	Description
D203-8	8" Long Nose Pliers Side-Cutting
D213-9NETP	Side Cutting and Tape Pulling Pliers, 9"
85191	Conduit-Fitting and Reaming Screwdriver
D248-8	8" Diagonal Cutting Pliers High Leverage
D502-10	Pump Pliers, 10"
506-10	10" Adjustable Wrench Standard Capacity
600-4	1/4" Screwdriver Heavy Duty Square Shank
601-6	3/16" Cabinet Tip Screwdriver 6"
602-6	5/16" Keystone Tip Screwdriver, 6" Length
603-4B	#2 Wire Bending Phillips Screwdriver
605-6	1/4" Cabinet Tip Screwdriver, Heavy Duty, 6"
630-3/16	3/16" Nut Driver with 3" Hollow Shaft
630-1/4	1/4" Nut Driver 3" Shaft Cushion Grip
630-5/16	5/16" Nut Driver Cushion-Grip 3" Shaft
630-11/32	11/32" Nut Driver 3" Hollow Shaft
630-3/8	3/8" Nut Driver with 3" Hollow Shaft
630-7/16	7/16" Hollow Nut Driver, 3", Cushion-Grip
630-1/2	1/2" Nut Driver, 3" Shaft, Cushion-Grip
662	#2 Square Screwdriver with 4" Round Shank
670-6	Screwdriver, 3/16" Cabinet, Rapi-Driv®, 6"
86125	25-Foot Non-Magnetic Tape Measure
935	Torpedo Level
1005	Crimping and Cutting Tool for Connectors
5102-16	16" Canvas Tool Bag
5139	Canvas Zipper Bag
11045	Wire Stripper/Cutter (10-18 AWG Solid)
44100	Utility Knife with Retractable Blade
60053	Protective Eyewear, Black Frame, Clear Lens

⚠WARNING: Blades are intended for cutting only, and should be handled and disposed of with care. Bending the blade can cause it to break, possibly resulting in bodily injury. Check local laws on legality of selling or possessing these knives.

⚠WARNING: Do NOT open the tape measure case. Spring motor is under tension, and opening may cause injury.



18-Piece Tool Kit



Cat. No.	Set Contains	Weight
80118		11.6 lb (5.3 kg)

Cat. No.	Description
J203-8N	Journeyman™ Long Nose Pliers Side Cutting, 8"
J502-10	Journeyman™ Pump Pliers, 10"
D507-10	Adjustable Wrench Extra Capacity, 10"
603-3	#1 Phillips Screwdriver, 3" Round Shank
603-4B	#2 Wire Bending Phillips Screwdriver
605-4	1/4" Cabinet Tip Screwdriver 4" Shank
605-6	1/4" Cabinet Tip Screwdriver, Heavy Duty, 6"
630-1/4	1/4" Nut Driver 3" Shaft Cushion Grip
630-5/16	5/16" Nut Driver Cushion-Grip 3" Shaft
662	#2 Square Screwdriver with 4" Round Shank
670-6	Screwdriver, 3/16" Cabinet, Rapi-Driv®, 6"
86225	Double Hook Magnetic Tape Measure, 25-Foot
J2000-9NETP	9" Journeyman™ Wire Pulling Pliers Heavy Duty Side Cutting
J2000-48	8" Diagonal HD Cutting Pliers Angled Head
5165	10 Pocket Tool Pouch Knife Snap
5705	PowerLine™ Web Work Belt
11055	Solid and Stranded Copper Wire Stripper and Cutter
60053	Protective Eyewear, Black Frame, Clear Lens

⚠WARNING: Blades are intended for cutting only, and should be handled and disposed of with care. Bending the blade can cause it to break, possibly resulting in bodily injury. Check local laws on legality of selling or possessing these knives.

⚠WARNING: Do NOT open the tape measure case. Spring motor is under tension, and opening may cause injury.

⚠WARNING: This is NOT an occupational protective belt.

80118

14-Piece Tool Kit



Cat. No.	Kit Contains	Weight
80014		9.6 lb (4.4 kg)

Cat. No.	Description
D203-8	8" Long Nose Pliers Side-Cutting
D213-9NETP	Side Cutting and Tape Pulling Pliers, 9"
D248-8	8" Diagonal Cutting Pliers High Leverage
D502-10	Pump Pliers, 10"
603-3	#1 Phillips Screwdriver, 3" Round Shank
603-4B	#2 Wire Bending Phillips Screwdriver
605-4	1/4" Cabinet Tip Screwdriver 4" Shank
605-6	1/4" Cabinet Tip Screwdriver, Heavy Duty, 6"
670-6	Screwdriver, 3/16" Cabinet, Rapi-Driv®, 6"
86125	25-Foot Non-Magnetic Tape Measure
5164	8-Pocket Tool Pouch Slotted
5225	Adjustable PolyWeb Tool Belt
11045	Wire Stripper/Cutter (10-18 AWG Solid)
60056	Protective Frameless Eyewear Clear Lens

⚠WARNING: Do NOT open the tape measure case. Spring motor is under tension, and opening may cause injury.

⚠WARNING: This is NOT an occupational protective belt.

80014





12-Piece Tool Kit



5300

Cat. No.	Kit Contains	Weight
5300		6.8 lb (3.1 kg)

Cat. No.	Description
5166	7-Pocket Tool Pouch
5225	Adjustable PolyWeb Tool Belt
603-3	#1 Phillips Screwdriver, 3" Round Shank
603-4	#2 Phillips Screwdriver 4" Round Shank
605-4	1/4" Cabinet Tip Screwdriver 4" Shank
605-6	1/4" Cabinet Tip Screwdriver, Heavy Duty, 6"
11045	Wire Stripper/Cutter (10-18 AWG Solid)
D248-8	8" Diagonal Cutting Pliers High Leverage
D203-8	8" Long Nose Pliers Side-Cutting
D213-9NETP	Side Cutting and Tape Pulling Pliers, 9"
D502-10	Pump Pliers, 10"
928-25HV	Tape Measure, High Visibility Case, 25-Foot

⚠ WARNING: Do NOT open the tape measure case. Spring motor is under tension, and opening may cause injury.

⚠ WARNING: This is NOT an occupational protective belt.

12-Piece Tool Kit



92003

Cat. No.	Kit Contains	Weight
92003		17.0 lb (7.7 kg)

Cat. No.	Description
D213-9NETP	Side Cutting and Tape Pulling Pliers, 9"
D248-8	8" Diagonal Cutting Pliers High Leverage
D203-8	8" Long Nose Pliers Side-Cutting
D502-10	Pump Pliers, 10"
11045	Wire Stripper/Cutter (10-18 AWG Solid)
86375	7.5 M Double Hook Magnetic Tape Measure
603-4	#2 Phillips Screwdriver 4" Round Shank
605-4	1/4" Cabinet Tip Screwdriver 4" Shank
661	Screwdriver, #1 Square Recess Tip, 4" Shank
662	#2 Square Screwdriver with 4" Round Shank
5719	PowerLine™ Series 18 Pocket Electrician Tool Pouch
5705	PowerLine™ Web Work Belt

⚠ WARNING: Do NOT open the tape measure case. Spring motor is under tension, and opening may cause injury.

⚠ WARNING: This is NOT an occupational protective belt.

6-Piece Trim-Out Tool Kit



80006

Cat. No.	Set Contains	Weight
80006		2.8 lb (1.3 kg)

Cat. No.	Description
603-4	#2 Phillips Screwdriver 4" Round Shank
605-4	1/4" Cabinet Tip Screwdriver 4" Shank
11055	Solid and Stranded Copper Wire Stripper and Cutter
D2000-9NE	9" Pliers Heavy Duty Side-Cutting
5204	Lightweight Utility Belt Blue
5119	4 Pocket Tool Pouch 6-1/2" x 8-1/2"

⚠ WARNING: This is NOT an occupational protective belt.

See page 297 for additional information on warnings.



Voice/Data/ Video Tools, Testers & Connectors

Our comprehensive line of verification VDV products was created to prep, connect and test network, phone, CATV, home theater, satellite, and security cables for residential or commercial systems.



For Professionals...
Since 1857™

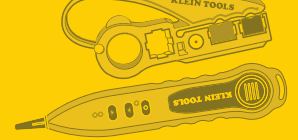

Cable Preparation

Radial Strippers

- Durable high-carbon steel cutting blades automatically adjust to cable diameter; won't damage internal conductors
- Finger loop design for smooth, easy rotation
- Slide depth gauge pre-measures coax cable for quick, precise and repeatable 5/16" and 1/4" (7.9 mm and 6.4 mm) strips
- Additional external blade in a structured design allows user to slit wire jacket for mid-span access or to open lengthwise (Cat. Nos. VDV110-261 and VDV110-295)
- Cat. No. VDV110-095 features two stripping cavities: one for standard size cable and one for utility size cables



US Patent: D688927

Cat. No.	Cable Size	Levels	Strip Dimensions	Prepared Cable	Handle Color	Weight
VDV110-261	CAT3, CAT5/5e, CAT 6/6A	1	Variable		Yellow/Blue	1.2 oz (34 g)
VDV110-061	RG59, RG6/6Q	2	0.3125" and 0.250" (7.94 and 6.35 mm)		Yellow/Black	1.2 oz (34 g)
VDV110-095	RG59, RG6/6Q, RG7, RG11	2	0.3125" and 0.250" (7.94 and 6.35 mm)		Yellow/Gray	1.5 oz (43 g)
VDV110-295	RG59, RG6/6Q; CAT3, CAT5/5e, CAT6/6A	Coaxial: 2, Twisted Pair: 1	Coaxial: 0.3125" and 0.250" (7.94 and 6.35 mm), Twisted Pair: Variable		Yellow/Blue	1.5 oz (43 g)

Cartridge Radial Strippers

- One-piece construction ensures precise stripping and never requires adjustment
- Multiple cable-type preparation
- Cartridges snap in from both sides for left or right-handed operation
- Large finger loop for easy rotation
- Includes storage cartridge-bay
- Additional and replacement cartridges available



VDV100-801

Cat. No.	Set Contains	Weight			
VDV100-801-SEN	Dual Cartridge Radial Stripper	0.10 lb (0.05 kg)			
Cat. No.	Cable Type	Color	Levels	Strip Dimensions	Prepared Cable
VDV110-003-SEN	RG59, RG6/6Q	Black	2	0.3125" x 0.250" (7.94 x 6.35 mm)	
VDV120-005-SEN	UTP Cable (CAT3, CAT5/5e and CAT6)	Blue	1	Variable	
Cat. No.	Set Contains	Weight			
VDV110-802-SEN	Cartridge Radial Stripper	0.10 lb (0.05 kg)			
Cat. No.	Cable Type	Color	Levels	Strip Dimensions	Prepared Cable
VDV110-003-SEN	RG59, RG6/6Q	Black	2	0.3125" x 0.250" (7.94 x 6.35 mm)	

Radial Stripper Cartridges

- Designed for use with: Dual Cartridge Radial Strippers (Cat. Nos. VDV100-801-SEN and VDV110-802-SEN)
- Pre-set cutting blades for precise, accurate and efficient cable stripping
- Durable high-carbon steel cutting blades are ground and honed for long life
- Patented "V" notch eliminates scoring of the center conductor (excluding Cat. No. VDV120-005-SEN)
- Color-coded for easy identification



Cat. No.	Cable Type	Color	Levels	Strip Dimensions	Prepared Cable	Weight
VDV120-005-SEN	UTP Cable (CAT3, CAT5/5e and CAT6)	Blue	1	Variable		1.0 oz (28 g)
VDV110-003-SEN	RG59, RG6/6Q	Black	2	0.3125" x 0.250" (7.94 x 6.35 mm)		0.9 oz (26 g)
VDV110-004-SEN	RG7, RG11	Gray	2	0.3125" x 0.250" (7.94 x 6.35 mm)		0.10 lb (0.05 kg)
VDV110-020	Mini-Coaxial Cable	Green	2	0.250" x 0.250" (6.35 x 6.35 mm)		0.10 oz (2.8 g)
VDV113-021	RG58, RG59, RG62	Green	3	0.234" x 0.234" x Variable (5.95 x 5.95 mm x Variable)		0.10 oz (2.8 g)
VDV113-022	RG58, RG59, RG62	Brown	3	0.109" x 0.312" x Variable (2.77 x 7.92 mm x Variable)		0.10 oz (2.8 g)

See page 297 for additional information on warnings.



Cable Connection — Coaxial

Compact, F-Connector

- Fixed plunger allows quick, easy insertion and removal of cable and connector
- Steel body with black-oxide finish for corrosion resistance and durability
- Compact tool with integrated handle lock
- Spring loaded return increases user comfort and ease of use



VDV212-008

Cat. No.	Cable Size	Connector Type	Overall Length	Weight
VDV212-008-SEN	RG59, RG6/6Q	Common F-Connectors	5.594" (142.1 mm)	0.10 lb (0.05 kg)

Compression Crimper - Compact, Multi-Connector (F, BNC, RCA)

- Adjustable universal plunger ensures accurate crimps on multiple types of connectors
- Steel body with chrome finish resists corrosion and extends tool life
- Open design for easy insertion, complete compression and simple removal of cable and connector
- F/BNC/RCA gauge markings on tool for accurate positioning and quick adjustment of the plunger
- Spring loaded return increases user comfort and ease of use



VDV211-048

Cat. No.	Cable Size	Connector Type	Overall Length	Weight
VDV211-048	RG59, RG6/6Q	BNC, F and RCA	5.594" (142.1 mm)	0.50 lb (0.23 kg)

Compression Crimper - Extended Reach, Multi-Connector (F, BNC, RCA)

- Optimized for confined-space and short cable installations and repairs
- Made of stamped steel for durability
- Adjustable extended length universal plunger ensures optimized crimping on multiple types of connectors
- Open-channel design for easy insertion of all connector head styles
- Integrated leverage point to assist connector installation
- Connector markings and mm scale are lasered into tool for consistent crimping



VDV211-100

Cat. No.	Cable Size	Connector Type	Overall Length	Weight
NEW VDV211-100	RG59, RG6/6Q	F, BNC, RCA	9" (228.6 mm)	0.8 lb (0.4 kg)

Compression Crimper - Lateral, Multi-Connector (F, BNC, RCA)

- One tool crimps most cable sizes
- Heavy-duty zinc die-cast chassis for durable, long lasting performance
- Unique cable selection wheel eliminates the need to change plunger tips, saving time and avoids losing parts
- Open design for easy insertion, complete compression and simple removal
- F/BNC/RCA gauge markings on tool for accurate positioning and quick adjustment of the plunger
- Spring loaded return increases user comfort and ease of use
- Integrated leverage point to assist connector installation



VDV211-063

Cat. No.	Cable Size	Connector Type	Overall Length	Weight
VDV211-063	Minicoax, RG58, RG59, RG62, RG6/6Q, RG7, RG11	F, BNC and RCA	6.25" (158.8 mm)	1.2 lb (0.5 kg)



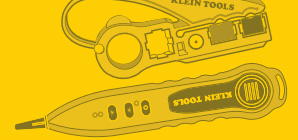

Cable Connection — Coaxial

Ratcheting Crimper Frame

- Professional CATV, electrical, home theater, satellite and security system ratcheting crimper frame with optional dies is perfect for fast, reliable connector installations
- Full-cycle ratchet action assures a complete, precise crimp every cycle
- Preset tension for optimum performance
- Ratchet mechanism is designed to prevent the release of the connector prior to full compression
- Safety crimp release helps eliminate rejected terminations due to incorrect positioning
- Steel body with black-oxide finish for corrosion resistance and durability
- Thumb-screws secure die-sets for quick, easy changes
- Optional, quick interchangeable die sets thumb and Phillips screw set available (see table)



VDV200-010

Cat. No.	Handle Color	Overall Length	Weight
VDV200-010	Black/Yellow	8.75" (222.3 mm)	1.2 lb (0.5 kg)

Coaxial Hex-Crimp Die Sets

NOTE: Use caution when tightening thumb screws to prevent thread damage/stripping and hand tighten only; do not over-tighten the thumb screws. Over-tightening thumb-screws can damage the tool and/or die set.

Cat. No.	Die Set	Nest Dimension
VDV999-033	Replacement Screw Set (Thumb and Phillips)	N/A
VDV212-034	CATV F Connectors RG59 RG6	0.255"/0.320"/0.350" 6.48/ 8.13/ 8.89 mm
VDV205-035	Insulated Terminals, AWG 10-22	AWG 22-18/16-14/12-10 DIN 0.5-1.0/1.5-2.5/4-6 mm
VDV205-036	Non-Insulated Terminal or Open Barrel Terminal, AWG 10-20	AWG 20-18/16, 14/12-10 DIN 0.75-1.5/2.5/4 - 6 mm

Cat. No.	Die Set	Nest Dimension
VDV211-037	RG58/RG59/ RG6/RG62	0.256"/0.319"/0.068"/0.213"/6.50/ 8.10/ 1.73/5.41 mm
VDV211-038	RG58/RG59/ RG6/RG62	0.256"/0.068"/0.213"/6.50/ 1.73/5.41 mm
VDV205-039	Pin Terminal Insulated or Non-Insulated Ferrules, AWG 12-22	AWG 22/20/18/16/14/12 DIN 0.5/0.75/1.0/1.5/2.5/4 mm
VDV201-040	RG58/RG59/ RG62/RG174 Fiber Optic	0.043"/0.068"/0.100"/0.137"/0.213"/0.255"/1.09/1.73/2.54/3.48/5.41/ 6.48 mm

Cat. No.	Die Set	Nest Dimension
VDV211-041	RG58/RG59/ RG6/RG62	0.255"/0.213"/0.098"/0.068"/0.321" 6.48/ 5.41/2.49/ 1.73/8.15 mm
VDV201-042	RG174/ RG179/Belden 8218 and Fiber Optic	0.042"/0.068"/0.078"/0.128"/0.151"/0.178"/1.07/7.73/1.98/ 3.25/3.84/ 4.52 mm
VDV211-043	RG8/RG11/ RG174/ RG179/RG213	0.100"/0.128"/0.429" 2.54/ 3.25/10.90 mm
VDV205-044	Non-Insulated Terminal, AWG 8-18	AWG 18-16/14 /12-10/8 DIN 0.75-1.5/ 2.54/ 4-6/ 10 mm

Standard Compression Connectors

- Full ferrule design
- Solid brass construction with nickel-plated finish
- Best choice for outdoors and satellite dishes

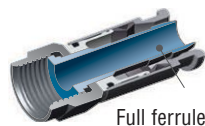

Full ferrule

Cat. No.	Connector Type	Cable Type	Package Quantity
VDV812-623	F-Connector	RG6	10
VDV812-624	F-Connector	RG6	50



VDV812-623

Push-On Connectors

- Patented, tool-less, easy grip design
- Fits most major brands
- For indoor use only



VDV812-627

Cat. No.	Connector Type	Crimping Type	Cable Type	Package Quantity
VDV812-627	F-Connector	Push-on	RG6/6Q	10

F-Splice Adapter 3 GHz

- Patented gripping mechanism for optimal signal strength



VDV814-609

Cat. No.	Package Quantity
VDV814-609	10

Universal Compression Connectors

- Fit all manufacturers' diameter variations within a cable series
- Fit difficult to work with multi-shield and plenum cables
- For indoor use only

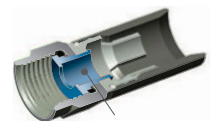

Compact ferrule

F • RG59



VDV812-615

BNC • RG59



VDV813-616

F • RG6/6Q



VDV812-606

BNC • RG6/6Q



VDV813-607

Cat. No.	Connector Type	Cable Type	Package Quantity
VDV812-615	F-Connector	RG59	10
VDV812-618	F-Connector	RG59	50
VDV812-606	F-Connector	RG6/6Q	10
VDV812-612	F-Connector	RG6/6Q	50
VDV813-616	BNC Connector	RG59	10
VDV813-619	BNC Connector	RG59	35
VDV813-607	BNC Connector	RG6/6Q	10
VDV813-613	BNC Connector	RG6/6Q	35



Cable Connection — Twisted Pair

Pass-Thru™ Modular Crimper, Ratcheting

- All-in-one tool cuts, strips and crimps paired-conductor data cables
- Fast, reliable modular crimp-connector installation for Pass-Thru™ RJ45 and standard RJ11/12 applications
- Full-cycle ratchet mechanism ensures complete connector termination
- Trims flush to end face of connector to eliminate unintended contact between conductors
- On-tool wiring guide helps minimize wiring errors
- Use with Klein Tools Pass-Thru™ Connectors
- Not for use with standard (non pass-through) connectors
- Replacement blades available (Cat. No. VDV999-076)



VDV226-110



REPLACEMENT
BLADE KIT
VDV999-076

Cat. No.	Cuts & Strips	Cable Size	Connector Type	Position/Pair/Conductors	Overall Length	Weight
VDV226-110	28-22 AWG (0.08 - 0.34 mm ²) Paired Conductor Data Cables	CAT3, CAT5e, CAT6/6A	RJ45 Klein Tools Pass-Thru™, and RJ11, RJ12 Standard	4-Position, 1-Pair/2-Conductor, 4-Position, 2-Pair/4-Conductor 6-Position, 2-Pair/4-Conductor, 6-Position, 3-Pair/6-Conductor, 8-Position, 4-Pair/8-Conductor	6.094" (154.8 mm)	0.90 lb (0.41 kg)

Compact Pass-Thru™ Modular Crimper

- Crimps and trims Klein Tools' RJ45 Pass-Thru™ connectors
- Trims flush to end face of connector to eliminate unintended contact between conductors
- On-tool wiring guide helps minimize wiring errors
- Fast, reliable RJ45 Pass-Thru™ modular crimp-connector installation for data applications
- Use with Klein Tools Pass-Thru™ Connectors
- Not for use with standard (non Pass-Thru™) connectors
- Replacement blades available (Cat. No. VDV999-078)



VDV226-005



REPLACEMENT
BLADE KIT
VDV999-078

Cat. No.	Cuts & Strips	Cable Size	Connector Type	Position/Pair/Conductors	Overall Length	Weight
NEW VDV226-005	—	CAT3, CAT5e, CAT6/6A	RJ45 Klein Tools Pass-Thru™	8-Position, 4-Pair/8-Conductor	5.5" (139.7 mm)	0.61 lb (0.28 kg)

Compact Ratcheting Modular Crimper

- All-in-one tool cuts, strips and crimps CAT6, CAT5e, CAT3 and flat-satin voice cables
- Crimps RJ11/12 and RJ45 modular connectors
- Full-cycle ratchet mechanism ensures complete connector termination
- Direct lateral crimp action provides more even, precise contact termination across all pins
- Compact, ergonomic design for natural, single-hand operation
- On-tool working guide helps minimize wiring errors
- Replacement blades available (Cat. No. VDV999-074)



VDV226-107



REPLACEMENT
BLADE KIT
VDV999-074

Cat. No.	Cuts & Strips	Cable Size	Connector Type	Position/Pair/Conductors	Overall Length	Weight
VDV226-107	STP/UTP Data Cable Flat-Satin Phone Cable 28-22 AWG (0.08 - 0.34 mm ²)	CAT3, CAT5e, CAT6	RJ11, RJ12 and RJ45 Standard	6-Position, 2 Pair/4-Conductor; 6-Position, 3-Pair/6-Conductor; 8-Position, 4-Pair/8-Conductor	5.25" (133.4 mm)	0.70 lb (0.32 kg)

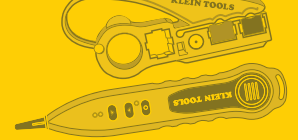

Cable Connection — Twisted Pair

Ratcheting Modular Crimper/Stripper

- Fast, reliable modular-crimp connector installation for voice and data applications
- All-in-one tool, cuts, strips and crimps paired-conductor cables (round STP/UTP and flat-satin phone cable)
- Crimps RJ45, RJ11 and RJ12 modular connectors
- Crimping dies are precision ground from high-carbon steel
- Ratchet safety-release and a blade-guard on cutting and stripping knives reduce risk of injury
- Full-cycle ratchet mechanism ensures complete connector termination
- Not for use with AMP® connectors
- Replacement blade set available (Cat. No. VDV999-064)



VDV226-011-SEN



REPLACEMENT
BLADE KIT
VDV999-064

Cat. No.	Cuts & Strips	Cable Size	Connector Type	Position/Pair/Conductors	Overall Length	Weight
VDV226-011-SEN	STP/UTP, Flat-Satin Phone Cable, and 22-28 AWG (0.08 - 0.34 mm ²)	CAT3, CAT5e, CAT6/6A	RJ45, RJ11, RJ12 Standard	4-Position, 1-Pair/2-Conductor, 4-Position, 2-Pair/4-Conductor 6-Position, 2-Pair/4-Conductor, 6-Position, 3-Pair/6-Conductor, 8-Position, 4-Pair/8-Conductor	7.5" (190.5 mm)	0.10 lb (0.05 kg)

AMP® is a registered trademark of TYCO, Inc.

Long-Nose Pliers - Connector Crimping

- Crimps UR/UY/UG insulation displacement connectors (IDC) - Scotchlok® type connectors
- Cleanly strips 23-24 AWG wire
- Grooved jaws for wire wrapping, looping and twisting
- Hot-riveted joint ensures smooth action and no handle wobble
- Induction-hardened cutting surface for long life



VDV026-049

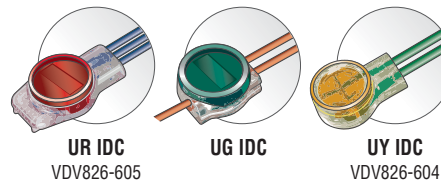

UR IDC
VDV826-605

UG IDC

UY IDC
VDV826-604

Cat. No.	Overall Length	Jaw Length	Jaw Width	Jaw Thickness	Point Diameter	Knife Length	Handle Color	Handle Finish	Weight
VDV026-049	6.8" (173 mm)	2" (51 mm)	0.7" (18 mm)	0.4 (10 mm)	0.095" x 0.125" (2.41 mm x 3.17 mm)	0.44" (11 mm)	Yellow	Plastic Dipped	0.28 lb (0.13 kg)

Scotchlok® is a registered trademark of 3M Corporation

Insulation Displacement Connectors

- Insulation displacement connector to add or terminate a telephone line
- Gel-filled for moisture resistance
- For use with Cat. Nos. VDV026-049, D234-6 and D234-6C crimping tools



UY IDC
VDV826-604 2 wire (26-22 AWG)



UR IDC
VDV826-605 3 wire (26-19 AWG)

Cat. No.	Connector Type	Position & Contacts	Connector Color	Package Quantity
VDV826-604	UY	2P2C	Yellow	25
VDV826-605	UR	3P3C	Red	25

See page 297 for additional information on warnings.



Cable Connection — Twisted Pair

Twisted Pair Connectors

- Professional-grade data and telephone plugs deliver consistent, reliable performance
- Featuring thick 50 micro-inch gold plating on three-pronged contacts for solid and stranded wire. Durable connector housings for a sure connection each and every time.

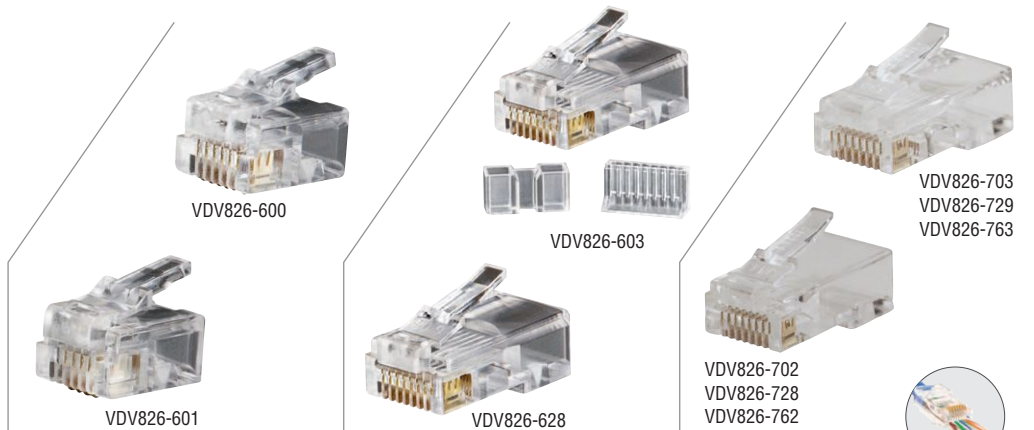

Connector Type	PHONE		STANDARD		PASS-THRU™	
	RJ11	RJ12	CAT5e	CAT6	CAT5e	CAT6
Position & Contacts	6P4C	6P6C	8P8C		8P8C	
Connector Design	1-Piece		1-Piece	3-Piece	1-Piece	
Gold Plating Thickness (micro-inch)	50µ"		50µ"		50µ"	
Cat. No.			VDV826-628	VDV826-603	VDV826-728	VDV826-729
Pack Size: 10						
Pack Size: 25	VDV826-601	VDV826-600				
Pack Size: 50			VDV826-602		VDV826-702	VDV826-703
Pack Size: 100			VDV826-611			
Pack Size: 200					NEW VDV826-762	VDV826-763
Crimping Type	Modular Plug Connector					
Klein Crimping Tools	VDV226-011, VDV226-107				VDV226-110, VDV226-005	

Telecom Tools

Can Wrench

- Two tools in one; saves space in your pouch
- One end opens telephone box fasteners, the other end tightens nuts on binding-post terminals
- The 7/16" socket has a black finish and the 3/8" socket has a silver finish
- Sockets are 1-1/4" (32 mm) deep to fit over long binding posts and are thin-walled for easy access into tight areas
- Hex-socket design enables using a wrench to obtain extra torque
- High-impact, break-resistant handle for long and dependable service
- Sockets are heat-treated, alloy steel



68005



Cat. No.	Socket Size	Handle Diameter	Overall Length	Weight
68005	3/8" and 7/16" Hex Nut	1" (25.4 mm)	7" (177.8 mm)	0.35 lb (0.16 kg)



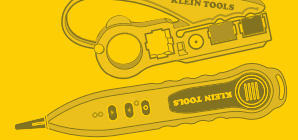

Installation Kits

VDV ProTech™ Kits

- For data and coaxial cable installations

















VDV026-831



VDV011-832



VDV001-833

Cat No.	Product	Description	VDV026-831	VDV011-832	VDV001-833
2100-8	 Free-Fall Snip – Stainless Steel	Stainless steel blades maintain blade durability and sharpness when cutting 19 and 23 AWG wire	•		•
63020	 Multi-Cable Cutter Klein-Kurve™	Cutter has a wide range of blades designed to cut various types of cable including solid and stranded copper wire, RG-59, RG6Q and RG-62 coaxial cable as well as other conductors		•	•
VDV000-133	 VDV ProTech™ Transport	Lightweight tool case with 12 organizational compartments for small parts and a large, open section to hold hand tools	•	•	•
VDV110-061	 Coax Cable Stripper – 2-Level, Radial	Provides one step, two-level stripping: 5/16" (7.9 mm) and 1/4" (6.4 mm)		•	•
VDV211-048	 Compression Crimper – Compact, Multi-Connector	Crimps compression (F, BNC, RCA) connectors to coaxial cable		•	
VDV211-063	 Compression Crimper-Lateral, Multi-Connector	One tool crimps most compression (F, BNC, RCA) connectors to most coaxial cables including Mini-Coax, RG58, RG59, RG62, RG6Q, RG7 and RG11			•
VDV226-107	 Compact Ratcheting Modular Crimper	All inclusive tool cuts, strips and crimps data cables and modular data plugs	•		•
VDV812-606	 Universal F Compression Connector – RG6/6Q	Patented universal sleeve technology installs up to 5X faster and fits all diameter variations of RG6/6Q cable		• 10 pack (x2)	• 10 pack (x2)
VDV812-615	 Universal F Compression Connector – RG59	Patented universal sleeve technology installs up to 2X faster and fits all diameter variations of RG59 cable		• 10 pack	• 10 pack
VDV812-623	 F Compression Connector – RG6	All metal construction with dual O-ring to seal out moisture – satellite provider approved		• 10 pack (x2)	• 10 pack (x2)
VDV813-607	 Universal BNC Compression Connector – RG6/6Q	Patented universal sleeve technology installs up to 5X faster and fits all diameter variations of RG6/6Q cable		• 10 pack	• 10 pack
VDV813-616	 Universal BNC Compression Connector - RG59	Patented universal sleeve technology installs up to 2X faster and fits all diameter variations of RG59 cable		• 10 pack	• 10 pack
VDV826-600	 Telephone Plug - RJ11 - 6P6C	Thick 50 micro-inch gold-plated and 3-pronged contacts with durable housing – for 1, 2 or 3 line telephones	• 25 pack		• 25 pack
VDV826-603	 Modular Data Plug – RJ45 - CAT6	Thick 50 micro-inch gold-plated and 3-pronged contacts with durable housing – 8 position, 8 contact 3-piece design for solid and stranded wire	• 25 pack		• 25 pack
VDV826-628	 Modular Data Plug – RJ45 - CAT5e	Thick 50 micro-inch gold-plated and 3-pronged contacts with durable housing – 8 position, 8 contact for solid or stranded wire	• 10 pack (x2)		• 10 pack (x2)

See page 297 for additional information on warnings.



Coaxial Installation Kits

Coax Cable Installation Kit with Hip Pouch

- Includes all the tools needed to cut, strip and crimp compression F-connectors to RG59/RG6/6Q cables
- Custom molded freestanding hip pouch with durable metal belt clip
- Multi-Cable Cutter has precision shear-type blades for easier cutting and double-dipped comfort grips with curved handles
- Radial Stripper with 2-level, one step prep has durable high-carbon steel pre-set cutting blades for precise, accurate cable stripping
- Compression Crimper features a fixed plunger for quick, easy insertion and removal of cable and connector
- Works with many commonly available compression F-connectors



VDV011-852

Cat. No.	Kit Contains	Weight
NEW VDV011-852	Coax Cable Installation Kit with Hip Pouch	1.6 lb (0.73 kg)
Cat. No.	Description	
VDV110-061	Coax Cable 2-Level Radial Stripper	
VDV212-008-SEN	Compact Compression Crimper, F-Connector	
63020	Multi-Cable Cutter Klein-Kurve®	

Coax Cable Installation Kit with Zipper Pouch

- Everything needed to prep and connect RG59/RG6/6Q coax cables with F-Connectors
- Includes a cable cutter, radial stripper, crimper, universal connectors and a zipper pouch for storage
- Multi-Cable Cutter has precision shear-type blades for easier cutting and double-dipped comfort grips with curved handles
- Radial Stripper with 2-level, one step prep has durable high-carbon steel pre-set cutting blades for precise, accurate cable stripping
- Crimper crimps compression F-Connectors to coaxial cable; fixed plunger allows quick, easy insertion and removal of cable and connector
- Includes 6 Universal RG6/6Q F-Compression Connectors (also available as a 10-pack, Cat. No. VDV812-606)
- Polyester zipper bag 7" x 12-1/2" (178 x 318 mm) keeps all components together



VDV026-211

Cat. No.	Kit Contains	Weight
NEW VDV026-211	Coax Cable Installation Kit with Zipper Pouch	1.5 lb (0.7 kg)
Cat. No.	Description	
63020	Multi-Cable Cutter Klein-Kurve®	
VDV110-061	Coax Cable 2-Level Radial Stripper	
VDV212-008-SEN	Compact Compression Crimper, F-Connector	
VDV812-606	Universal F Compression Connectors RG6/6Q 10-Pack	



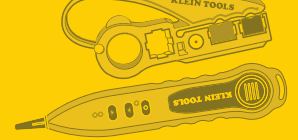

Coaxial Installation and Test Kits

Coax Installation & Test Kit

- Includes tools needed to prepare, connect and test coax cables
- Radial Stripper designed for easy single operation cable preparations
- Crimper crimps compression F-connectors to coaxial cable quickly and reliably
- Coax Explorer™ 2 Tester tests and verifies coaxial cable connections (good/open/short)
- Universal F-Compression Connectors - RG6/6Q: Patented design installs up to 5X faster



Cat. No.	Kit Contains	Weight
VDV002-818	Coax Cable Installation & Test Kit	1.1 lb (0.5 kg)
Cat. No.	Description	
VDV212-008-SEN	Compact Compression Crimper, F-Connector	
VDV110-061	Coax Cable 2-Level Radial Stripper	
VDV512-100	Coax Explorer® 2 Tester	
VDV812-606	Universal F Compression Connectors RG6/6Q 10-Pack	

VDV002-818

Coax Push-On Connector Installation & Test Kit

- Includes tools needed to prepare and test push-on coax cables
- Radial Stripper designed for easy single operation cable preparations
- Coax Explorer™ 2 Tester tests and verifies coaxial cable connections (good/open/short)
- Push-On F-Connectors feature patented cable grip design for easy installation and strong hold with no tool required



Cat. No.	Kit Contains	Weight
VDV002-820	Coax Push-On Connector Installation and Test Kit	0.28 lb (0.13 kg)
Cat. No.	Description	
VDV110-061	Coax Cable 2-Level Radial Stripper	
VDV512-100	Coax Explorer® 2 Tester	
VDV812-627	Push-On F Connectors RG6/6Q 10-Pack	

VDV002-820

Twisted Pair Installation Kits

Modular Installation Kit

- Includes tools needed to prepare and connect modular cables
- Ratcheting Modular Crimper/Stripper cuts, strips and crimps paired-conductor data cables (RJ11/RJ12, RJ45)
- Modular Data Plugs - RJ45 - CAT5e: Thick 50 micro-inch gold plating and 3-pronged contacts with durable housing - 8 position, 8 contact for data cables
- Telephone Plugs - RJ11 - 6P6C: Thick 50 micro-inch gold plating and 3-pronged contacts with durable housing - for 1, 2 or 3 line telephones



Cat. No.	Kit Contains	Weight
VDV226-817	Modular Installation Kit	0.76 lb (0.34 kg)
Cat. No.	Description	
VDV226-011-SEN	Ratcheting Modular Crimper/Stripper	
VDV826-628	Modular Data Plugs, RJ45, CAT5e, 10-Pack	
Kit exclusive	Telephone Plugs, RJ11, 10-Pack	

VDV226-817

See page 297 for additional information on warnings.



Twisted Pair Installation Kits

Twisted Pair Installation Kit with Zipper Pouch

- All the tools needed to strip, crimp, and punch down, to connect modular cables, plus a zippered pouch to keep everything together
- Radial Stripper (Cat. No. VDV110-261) with durable high-carbon steel blade automatically adjusts to cable diameter to avoid damaging conductors
- Ratcheting Modular Crimper/Stripper (Cat. No. VDV226-011) cuts, strips and crimps data cables
- 110-Type Punchdown Tool with Klein's exclusive DuraBlade™ precision cutting edge for clean, accurate wire termination
- RJ45-CAT5e Modular Data Plugs (6-Pack)
- Polyester zipper bag keeps everything together
- RJ45-CAT5e Modular Data Plugs also available as a 25-pack (Cat. No. VDV826-603)



VDV026-212

Cat. No.	Kit Contains	Weight
NEW VDV026-212	Twisted Pair Installation Kit with Zipper Pouch	1.3 lb (0.6 kg)
Cat. No.	Description	
VDV110-261	Twisted Pair Radial Stripper	
VDV226-011	Ratcheting Modular Crimper/Stripper	
Kit Exclusive	110 Punchdown tool	
Kit Exclusive	CAT5e, RJ45 connectors, 6-Pack	

Twisted Pair Installation and Test Kits

LAN Installer Starter Kit - Modular

- Includes the tools needed to prepare, connect and test modular data cables
- Durable nylon tool pouch designed specifically for modular plug installation tools
- Two additional pockets hold a screwdriver and common AA battery flashlights
- Pouch includes a closeable pocket that will hold up to 25 RJ45 plugs (not included)
- Tunnel-loop accommodates up to 2" belt



VDV026-812

Cat. No.	Kit Contains	Weight
VDV026-812	LAN Installation and Tester Starter Kit	1.5 lb (0.7 kg)
Cat. No.	Description	
2100-8	Free-Fall Snip Stainless Steel	
VDV226-011-SEN	Ratcheting Modular Crimper/Stripper	
VDV526-052	LAN Scout Jr. Continuity Tester	
98554	Fine Point Permanent Markers, Pk 2	
Kit exclusive	5-pocket nylon pouch plus closeable consumables pocket	



Cable Testers

Pocket Continuity Tester for Coax Cable

- Simple compact wire tracing of coaxial cables
- Identifies and tests cable drops for pass, short faults and location via audible beep and LED indicators
- LED lights green on a correctly made cable drop, red for short fault
- Remote contains loud audible beep for easy location identification
- Replaceable AAA Alkaline battery, included
- Female to female F-adapter (included) enables testing of loose cables and installed cable runs
- Docked remote switches tester off to conserve battery life
- Pocket clip secures tester to shirt pocket



VDV512-007

Cat. No.	Location ID	Batteries	Included	Weight
NEW VDV512-007	1	1 x AAA	F-adapter, Pocket Clip, Battery	4.8 oz (136 g)

Coax Explorer™ 2 Testers

- Test coaxial cable and map up to 4 locations
- Simple push button operation
- Easy to read LED panel indicates PASS, OPEN or SHORT conditions, simplifying cable identification
- (2) Replaceable AAA Alkaline batteries, included
- Push-on remotes for ease of use
- Cat. No. VDV512-101 includes a removable holder with 4 color coded remotes to trace up to 4 locations at the same time



REMOTE REPLACEMENT KIT
VDV512-110



VDV512-100



VDV512-101



Cat. No.	Cable Type	Test-n-Map ID Remotes	Location ID	Batteries	Display	Included	Weight
VDV512-100	RG59, RG6/6Q, RG7, RG11	(1) Red Remote (included)	1	2 x AAA	LED	Batteries, Red Remote	3.0 oz (85g)
VDV512-101	RG59, RG6/6Q, RG7, RG11	4 (Included)	4	2 x AAA	LED	Batteries, 4 Colored Push-on Remotes, F-adapter, Snap-on Remote Holder	4.8 oz (136 g)

LAN Scout™ Jr. Tester

- Tests continuity on twisted pair data wiring (RJ45) connections
- Tone generator with 4 distinct tones
- Heavy-duty ports are designed for long life and repeated connections
- Large display with pin-to-pin wire map for easy identification
- Compact, contoured dual-material chassis fits comfortably in your hand
- Remote stores in tester



RJ45 Port



Self Storing Remote



VDV526-052



Features	VDV526-052
RJ45 8-wire Cables	•
Continuity Testing	•
Pass TIA-568A/B & Crossover/Uplink	•
LCD LCD Display	•
1 2 3 4 Wiremap	•
Open Fault	•
Short Fault	•
Miswire Fault	•
Split Pair Fault	•
Tones	4
Self-Storing Remote	•
Low Battery	•
Apo Auto Power Off	•
Voltage Warning	•
Shield Detection	•

Cat. No.	Cable Type	Test-n-Map ID Remotes	Location ID	Batteries	Display	Included	Weight
VDV526-052	CAT3, CAT5/5e, CAT6/6A	—	—	6V to 4 x LR44 Alkaline	LCD	Batteries	0.25 lb (0.11 kg)

See page 297 for additional information on warnings.



WARNING: Do NOT use on energized circuits or cabling systems.













Cable Testers

VDV Ranger™ TDR Kit

- Measure paired-conductor data cable length up to 3,000 ft. (914 m) including voice, data, video, doorbell, siamese, lamp-wire and NM cables
- Time Domain Reflectometry Spread Spectrum (TDR-SS) Technology provides superior accuracy up to +/- (1% + 3 ft) by eliminating interference when measuring cable
- Measure cable remaining in box or on a reel
- Determine if cable run is broken or damaged
- TDR-SS technology broadens TDR environments by operating in Safety Extra Low Voltage (SELV) rated environments as defined by IEC. (SELV is 60 volts DC or Peak AC - 45 volts RMS)
- Tone Generator traces and identifies cables†
- Simplify cable estimating and bill jobs more accurately



VDV501-815

Features	VDV501-815	
Interface		Multi-Adapter Set
Measures Cable Length		•
Length Measurement Method	TDR-SS Spread Spectrum Time Domain Reflectometry	•
Accuracy & Resolution Measurement	±(1% + 3 ft.) ± (1% + 1 m)	•
Maximum Cable Length	3,000 ft. / 914 m	
Common Cable Length Ranges Must be paired conductors		
RJ45 8-Cables		0 - 1,500 Ft. (457 m)
Coaxial Cable		0 - 2,000 Ft. (609 m)
Electrical Cable		0 - 1,000 Ft. (305 m)
Imperial & Metric Results	Ft./m	•
On-Board Calibration Memory		2 Storage Locations
Open Fault		•
Short Fault		•
Tones†		4
Display		2.25" (57 mm) Backlit LCD
Voltage Warning		•
Low Battery		•
Auto Power Off	Apo	•



Includes custom designed polyester carrying case.



Cat. No.	Batteries	Battery Life	Included	Weight
VDV501-815	(4) AA Alkaline Batteries Included	15 Hours Active, 4 Years Standby	Tester, Adapter Cord Set (BNC to F-connector adapter, F-connector adapter, Insulated Push-on F-connector to alligator clips; Insulated BNC Connector to alligator clips; Insulated Push-on F-Connector to RJ45 plug) and Carrying Case	0.75 lb (0.34 kg)

†Requires analog tone tracing probe VDV500-060 (sold separately).



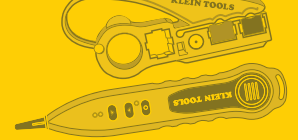

Cable Testers

VDV Commander™

- Locate, test and measure coaxial, data (RT45) and telephone (RJ11/RJ12) cables
- Measure cable length and Distance-to-Fault with Time Domain Reflectometry (TDR) technology
- Locate and identify cables with location ID remotes, Test-n-Map™ remotes, Link Light and Tone Generator†
- Detect, identify and test Power-over-Ethernet (PoE)
- Perform active network (Ethernet) testing
- Store up to 256 cable or network tests that can be exported to print reports
- Tester battery life of 20 hours active and 4 years standby
- Probe battery life of 25 hours active and 4 years standby



Features		
	RJ-45 8-Wire Cables	•
	F-connector Coaxial Cables	•
	Telephone Cables	with adapter
	Wiremap	•
	Open Fault	•
	Short Fault	•
	Miswire Fault	•
	Split-Pair Fault	•
Pass	TIA-568A/B & Crossover/Uplink	•
	Active Ethernet - Detects link speed and capabilities	•
	Single-End Cable Testing	•
	Test-n-Map™ Remote (Two End Testing) - Test and Identify location in one step with remote	supports up to 8
PoE	Power-Over-Ethernet Testing	•
TDR	Time Domain Reflectometry - Length Measurement Method	•
	Measures Cable Length	1500 ft. / 457 m
$\pm(5\% + 1 \text{ Ft.})$ $\pm(5\% + 0.3 \text{ m})$	Accuracy/ Measurement Resolution	•
	Link Light	•
ID	Cable Identification (Coaxial & Data)	supports up to 20
	Shield Detection	•
	Voltage Warning	•
	Low Battery Indicator	•
	Store Test Results	256
	Print / Export Custom Reports	•
	Tones* (Down to Single Conductor/Pair/Cable)	4
	Color LCD Display	2.7" (68.6 mm)
	Multiple Languages	ENG · ESP · FRA
Ft./m	Imperial or Metric Results	•
Apo	Auto Power Off	•
	Customizable Setup	•
	USB interface (for PC connection)	MICRO
	Upgradeable Firmware (via internet download & pc connection)	•

VDV Commander™ Kits



VDV501-828



VDV501-829

Cat. No.	Cable Type	Test-n-Map ID Remotes	Location ID	Batteries	Display	Included	Weight
VDV501-828	RG59, RG6/6Q, RG7/11, CAT3, CAT5, CAT6/6A	1	5	6 x AA	LCD	Tester, Test-n-Map Remote #1, (5) LanMap ID Remotes, (5) CoaxMap ID remotes, USB/RJ12/RJ45 Test Cables, Coax Adapter, (6) AA Batteries, Carrying Case	12 oz (340 g)
VDV501-829	RG59, RG6/6Q, RG7/11, CAT3, CAT5, CAT6/6A	1	20	Commander: 6 x AA Alkaline Probe: 1 x 9V Alkaline	LCD	Tester, Probe, Test-n-Map Remote #1, (20) LanMap ID Remotes, (20) CoaxMap ID remotes, USB/RJ12/RJ45 Test Cables, Coax Adapter, (6) AA Batteries, 9V Battery, Carrying Case	12 oz (341 g)

† Functionality requires an analog tone tracing probe VDV500-060 (Included with Cat. No. VDV501-829).

See page 297 for additional information on warnings.



WARNING: Do NOT use on energized circuits or cabling systems.

Cable Testers

VDV Scout™ Pro 2 Series

CE	VDV Scout™ Pro 2	VDV Scout™ Pro 2 LT
Features	VDV501-098	VDV501-108
Tests RJ45 8-wire cables	●	●
Tests RJ11/12 6-wire cables	●	●
Tests F-connector coaxial cables	●	●
Continuity testing	●	●
Pass TIA-568A/B & crossover/uplink	●	●
Wiremap	●	●
Detects open faults	●	●
Detects short faults	●	●
Detects miswires	●	●
Detects split pairs	●	●
Measures cable length	—	●
Test-n-Map™ Remotes	Supports up to 8	Supports up to 8
ID	Twisted-pair (RJ45) cable ID location remotes	Supports up to 19
	Coaxial F-connector cable ID location remotes	Supports up to 19
Tones	4	4
Low battery indicator	●	●
Voltage warning	●	●
Shield detection	●	●
Apo Auto power off	●	●
Kit Cat. No.	VDV501-823 VDV501-824	VDV501-825 VDV501-826

Top View: RJ45, RJ11/12 and F-connector ports

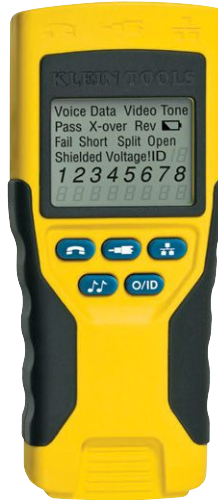

VDV Scout™ Pro 2 with Self-Storing Remote



VDV Scout™ Pro 2 with Test-n-Map™ Remote



VDV Scout™ Pro 2 LT with Test-n-Map™ Remote



Kit VDV501-823 Kit Self Storing Remote

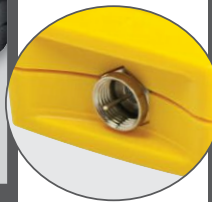

Coax interface on opposite end



Kits VDV501-824, VDV501-825, VDV501-826 Test-n-Map™ Self Storing Remote

Cat. No. VDV501-098 and VDV501-108 are only available as part of the kits shown on the next page. They are not available for individual purchase.



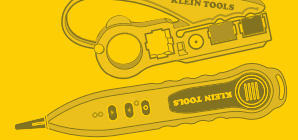

Cable Testers

VDV Scout™ Pro 2 Series Kits

- Tests continuity on voice (RJ11/12), data (RJ45) and video (F-connector) connections
- Locates cable runs to wall outlets with location ID remotes
- Compatible with single-step Test-n-Map™ Remotes
- Supports multiple tones and control of pins carrying tone with integrated tone generator†
- Measures cable length in feet or meters (LT models only)

Items Included	Cat. No.	VDV Scout™ Pro 2 Tester Kit	VDV Scout™ Pro 2 Tester & Test-n-Map™ Remote Kit	VDV Scout™ Pro 2 LT Tester & Remote Kit	VDV Scout™ Pro 2 LT Tester & Test-n-Map™ Remote Kit	VDV Scout™ Pro 2 Test-n-Map™ Remote Kit
		VDV501-823	VDV501-824	VDV501-825	VDV501-826	VDV770-827
VDV Scout™ Pro 2 Tester		VDV501-098	VDV501-098	—	—	—
VDV Scout™ Pro 2 LT Tester		—	—	VDV501-108	VDV501-108	—
Test-n-Map™ Remotes		—	8	1	8	8
LanMap™ Cable Identification Location Remotes		5	—	19	—	—
CoaxMap™ Cable Identification Location Remotes		5	—	19	—	—
Coax barrel F adapter (female to female)		1	1	1	1	—
Coax push-on F adapter (threaded male to push-on female)		—	8	—	8	8
RJ45 jumper test cable (9')		—	8	—	8	8
9V battery		•	•	•	•	•
Carrying case		—	•	•	•	•

† Functionality requires an analog tone tracing probe VDV500-060 (Included with Cat. No. VDV501-829).



VDV Scout™ Pro 2 Tester Kit
VDV501-823



VDV Scout™ Pro 2 LT Tester & Remote Kit
VDV501-825



VDV Scout™ Pro 2 Test-n-Map™ Remote Kit
VDV770-827



VDV Scout™ Pro 2 Tester & Test-n-Map™ Remote Kit
VDV501-824



VDV Scout™ Pro 2 LT Tester & Test-n-Map™ Remote Kit
VDV501-826



Carrying case is also available separately
VDV770-080

See page 297 for additional information on warnings.



WARNING: Do NOT use on energized circuits or cabling systems.

Cable Tester Accessories

Test-n-Map™ Remote Kit for VDV Commander™ Series

- Test, map and identify a location in a single step
- Cuts testing and identification time in half
- Test and identify up to eight locations at once



Cat. No.	Included	Weight
VDV770-834	(7) Test-n-Map™ Remotes, (8) Coax Push-on F Adapters, (8) RJ45 Jumper Test Cables, (2) RJ11/RJ12 Jumper Cables, Verification Cable, Zipper Pouch	1.4 lb (0.6 kg)

Tester sold separately.



Test-n-Map™ Remotes

- Replacement remotes to test, map and identify a location in a single step
- Pin-to-Pin testing of RJ45 data, RJ11/RJ12 voice and mapping of F-connector coax connections
- For use with the Scout Pro™ and Commander™ Series of testers (sold separately)
- Remotes are numbered and identifiable by tester for fast, accurate tracing/mapping of locations



Cat. No.	Description	For Use With	Weight
VDV501-111	Test-n-Map™ ID Remote #1	Scout Pro™ Series (VDV501-823; -824; -825; -826; -827) and Commander Series (VDV501-828; -829)	1.4 oz (39.7 mm)
VDV501-112	Test-n-Map™ ID Remote #2	Scout Pro™ Series (VDV501-823; -824; -825; -826; -827) and Commander Series (VDV501-828; -829)	1.4 oz (39.7 mm)
VDV501-113	Test-n-Map™ ID Remote #3	Scout Pro™ Series (VDV501-823; -824; -825; -826; -827) and Commander Series (VDV501-828; -829)	1.4 oz (39.7 mm)
VDV501-114	Test-n-Map™ ID Remote #4	Scout Pro™ Series (VDV501-823; -824; -825; -826; -827) and Commander Series (VDV501-828; -829)	1.4 oz (39.7 mm)
VDV501-115	Test-n-Map™ ID Remote #5	Scout Pro™ Series (VDV501-823; -824; -825; -826; -827) and Commander Series (VDV501-828; -829)	1.4 oz (39.7 mm)
VDV501-116	Test-n-Map™ ID Remote #6	Scout Pro™ Series (VDV501-823; -824; -825; -826; -827) and Commander Series (VDV501-828; -829)	1.4 oz (39.7 mm)
VDV501-117	Test-n-Map™ ID Remote #7	Scout Pro™ Series (VDV501-823; -824; -825; -826; -827) and Commander Series (VDV501-828; -829)	1.4 oz (39.7 mm)
VDV501-118	Test-n-Map™ ID Remote #8	Scout Pro™ Series (VDV501-823; -824; -825; -826; -827) and Commander Series (VDV501-828; -829)	1.4 oz (39.7 mm)

LanMap™ Kit and CoaxMap™ Kit

- Identify and map twisted-pair (RJ45) infrastructure (Cat. No. VDV526-055) or coaxial (F-connector) cable infrastructure (Cat. No. VDV512-056), up to 19 locations
- For use with VDV Scout™ Pro Series and VDV Commander™ testers
- Heavy-duty design for long life and repeated connections
- Remotes numbered and identifiable by tester 1 through 19 for fast and accurate identification



VDV512-056



VDV526-055



Cat. No.	Description	For Use With	Weight
VDV526-055	LanMap™ Kit	Scout Pro™ Series (VDV501-823; -824; -825; -826; -827) and Commander Series (VDV501-828; -829)	0.12 lb (0.05 kg)
VDV512-056	CoaxMap™ Kit	Scout Pro™ Series (VDV501-823; -824; -825; -826; -827) and Commander Series (VDV501-828; -829)	0.33 lb (0.15 kg)





Tone & Probe

TONEcube & PROBEplus Kit

- Trace wire paths and identify cables in common wiring systems
- Uses a 9-volt alkaline battery (not included)
- Five unique tracing tones
- Zip pouch for storage

Cat. No.	Kit Contains	Weight
VDV500-808	TONEcube & PROBEplus Tone and Probe Tracing Kit	1.0 lb (0.5 kg)
Cat. No.	Description	
VDV500-051	TONEcube Tone Generator	
VDV500-060	PROBEplus Tone Tracing Probe	



VDV500-808

PROBEplus-Tone Tracing Probe

- Trace wire paths and identify cables in common wiring systems
- Amplifier overload LED improves accuracy, warning against misreads
- Dual mode power button with Power-On LED indicator - tap or hold
- Recessed buttons prevent accidental operation
- Works with other manufacturers' analog tone generators
- Replacement tips available (Cat. No. VDV999-065)



VDV500-060



Features	VDV500-060
O.L. Amplifier Overload Indication	●
Adjustable Digital Volume Control	●
Tap-Mode Operation	●
Hold-Mode Operation	●
Power-On LED Indicator	●
Visual Notification	●
Apo Auto Power-Off	●
Low Battery Indicator	●
Replaceable Tip	●
Lanyard Attachment Loop	●

Cat. No.	Batteries	Overall Length	Overall Height	Overall Width	Weight
VDV500-060	9V (Not Included)	1.141" (29 mm)	9.906" (251.6 mm)	2" (50.8 mm)	0.38 lb (0.17 kg)

TONEcube-Tone Generator

- Alligator clips for unterminated cable
- Single modular RJ12 plug for direct connection to RJ11/RJ12 or RJ45 jacks.
- Transmits five discrete tracing tones
- Constant output level over useful battery life
- Momentary slide switches prevent accidental operation
- Works with other manufacturers' analog tone probes



VDV500-051



Features	VDV500-051
Tones	5
Heavy-Duty Leads	●
Rugged Universal RJ11/RJ12/RJ45 Modular Plug	●
Continuity Testing	●
O.L. Voltage Overload Protection	●
+/- Line Status & Polarity	●
Power-On Flashing LED Indicator	●
Apo Auto Power-Off	●
Low Battery Indicator	●
Lanyard Attachment Loop	●

Cat. No.	Batteries	Overall Length	Overall Height	Overall Width	Weight
VDV500-051	9V (Not Included)	1.422" (36.1 mm)	2.703" (68.7 mm)	2.5" (63.5 mm)	0.31 lb (0.14 kg)

See page 297 for additional information on warnings.



WARNING: Do NOT use on energized circuits or cabling systems.

Tone & Probe

TraceAll™ Tone & Probe

- Trace wire paths and identify cables in common wiring systems
- Heavy-duty RJ11 jack on tone generator for long life and repeated connections
- Includes RJ11 adapter to convert tone generator to an alligator-clip configuration
- Dual material chassis fits comfortably in your hand
- Replacement tips available (Cat. No. VDV999-059)
- Replacement adapter cable available (Cat. No. VDV999-067)



VDV526-054

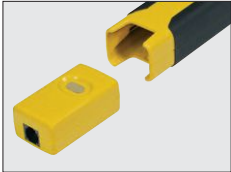

Self Storing Tone Generator

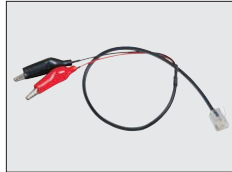

Adapter

Features	VDV526-054
Tone Generator	2
Adjustable Volume	●
Self-Storing Remote	●
Apo Auto Power-Off	●
Replaceable Tip	●



Cat. No.	Batteries	Overall Length	Overall Height	Overall Width	Weight
VDV526-054	6V 4 x LR44 Alkaline (Included)	1.203' (30.6 mm)	8.891' (225.8 mm)	1.703' (43.3 mm)	0.31 lb (0.14 kg)

Punchdown Tools

LAN Installer Starter Kit - Punchdown

- Includes the tools needed to prepare and connect 66 type and 110 type punchdown terminal blocks
- Durable nylon tool pouch designed specifically for punchdown installation tools
- Two additional pockets hold a screwdriver and common AA battery flashlights
- Tunnel-loop accommodates up to 2" (51 mm) belt

Cat. No.	Kit Contains	Weight
VDV027-813	LAN Installer Starter Kit, Punchdown	0.88 lb (0.40 kg)
Cat. No.	Description	
2100-8	Free-Fall Snip Stainless Steel	
VDV427047	Punchdown Multi-Tool Chassis	
VDV427-015-SEN	110 Punchdown Blade	
VDV427-104	Dura-Blade™ 110/66 Cut Punchdown Blade	
98554	Fine Point Permanent Markers, Pk 2	



VDV027-813

Punchdown Screwdriver Multi-Tool

- Terminate and cut wire in one step with 110/66 combination cut-type punchdown blade with precision ground cutting edge
- Non-impact wire termination
- Machine-tooled steel bits for superior strength
- Heavy-duty blade barrel provides storage for bits
- Bayonet-style (twist & lock) socket accepts most manufacturers' punchdown blades
- Cushion-Grip handle for greater torque and enhanced comfort
- Tip-Ident™ for quick identification of tool



VDV001-081



US Patent: 8856994

Cat. No.	Nut Driver Sizes	Phillips Bits	Slotted Bits	Hex Bits	Other Bits	Overall Length	Weight
VDV001-081	1/4", 3/8"	#1, #2	1/4" (6.4 mm), 3/16" (4.8 mm)	3/8"	66/110 Terminate and Cut	8" (203.2 mm)	0.59 lb (0.27 kg)



Punchdown Tools

Cushion-Grip Impact Punchdown Tools

- 4-piece tool kit for termination of 110/66 panels, cross-connect systems and wall jacks
- Punchdown Tool (Cat. No. VDV427-821) includes a "Hi/Lo" impact functionality to adjust compression force on various wire gauges, blocks and jacks (US Patent D718585)
 - Integrated, extra-long shaft for reaching into bulky/crowded blocks and a heavy-duty metal collar for strength and longevity
 - Cushion-Grip handle reduces hand fatigue and provides superior comfort
- Wire Pick (Cat. No. VDV327-103) used to pick-up, separate or remove wires, small components, covers or debris from panels, blocks or jacks
 - Features a metal hook end with non-conductive spudger and body to prevent shorts
- Dura-Blade (Cat. No. VDV427-104) manufactured using a metal injecting molding (MIM) technology for better quality, durability and performance
 - Blade has both 110 and 66 cut/terminate edges for clean, accurate wire insertion and trimming and is compatible with most bayonet style (twist & lock) socket punchdown tools
- Kit-exclusive Multi-Pocket Pouch features a metal belt clip and a reinforced puncture-resistant bottom



VDV427-822

Cat. No.	Set Contains			Weight
VDV427-822				0.93 lb (0.42 kg)
Cat. No.	Description	Configuration End 1	Configuration End 2	
VDV427-821	Cushion-Grip Impact Punchdown Tool w/Dura-Blade™	110 Terminate and Cut	66 Terminate and Cut	
VDV327-103	Wire Pick	Metal Hook End	Non-Conductive Spudger End	
VDV427-104	Dura-Blade™ 110/66 Cut Punchdown Blade	110 Terminate and Cut	66 Terminate and Cut	

Items also sold separately

Punchdown Multi-Tool with 110/66 Blade and WorkEnds™ Kit

- Terminate and cut wire in one step with precision ground-combination 100/66 blade (included)
- Workends™ Kit converts chassis into a multi-bit driver with four driver bits (#1/#2 Phillips; 3/16"/1/4" Slotted), adapter and reach extension
- Selectable (Hi/Low) impact-force settings adjust compression force
- Spring loaded for fast, low effort seating and terminating
- Integrated hook and spudger easily manipulates wire and small components and stores in chassis
- Locking impact mechanism allows for operation and sure driving with a variety of optional WorkEnds™ driver bits
- Blade storage compartment with spring loaded locking mechanism
- Replacement blades/accessories available



INTEGRATED HOOK AND SPUDGER STORE IN CHASSIS

VDV427-807

Cat. No.	Set Contains			Weight
VDV427-807				0.47 lb (0.21 kg)
Cat. No.	Description	Configuration End 1	Configuration End 2	
VDV427-104	Dura-Blade™ 110/66 Cut Punchdown Blade	110 Terminate and Cut	66 Terminate and Cut	
VDV770-050	WorkEnds Kit for VDV427-047	Proprietary Magnetic Hex	1/4" Female Hex	

See page 297 for additional information on warnings.



WARNING: Do NOT use on energized circuits or cabling systems.

Punchdown Tools

Impact Punchdown Tools

- Terminate cable in variety of cross-connect panels, blocks and keystone jacks
- Spring loaded for fast, low effort seating and terminating
- Selectable (Hi/Low) impact-force settings
- Rubber finger grips and boot provide greater control and enhanced comfort
- Blade storage compartment with spring loaded locking mechanism
- Bayonet style (twist & lock) socket accepts most manufacturers' tools and blades
- Induction-hardened high-carbon steel for durability and long life
- Replacement blades available



VDV427-800



VDV427-104



VDV427-015-SEN

Cat. No.	Set Contains	Weight	
VDV427-800-SEN	Impact Punchdown Tool, 110/66 Blade	0.44 lb (0.20 kg)	
Cat. No.	Description	Configuration End 1	Configuration End 2
VDV427-013	Impact Punchdown Tool	-	-
VDV427-104	Dura-Blade™ 110/66 Cut Punchdown Blade	110 Terminate and Cut	66 Terminate and Cut
Cat. No.	Set Contains	Weight	
VDV427-805-SEN	Impact Punchdown Tool, 110 Blade	0.10 lb (0.05 kg)	
Cat. No.	Description	Configuration End 1	Configuration End 2
VDV427-013	Impact Punchdown Tool	-	-
VDV427-015-SEN	110 Punchdown Blade	110 Terminate	110 Terminate and Cut

Punchdown Accessories

- Blades compatible with Klein® punchdown tools and other bayonet style (twist & lock) socket tools
- Precision ground cutting-edge for clean, precise wire termination (depending on blade type)
- Terminate, and adjust cable in variety of cross-connect panels, blocks and keystone jacks
- Induction-hardened high-carbon steel blades for durability and long life
- Reversible blades with termination/cutting ends and termination only ends (depending on blade type)
- WorkEnds™ Kit converts the Punchdown Multi-Tool chassis (Cat. No. VDV427-047) into a multi-bit driver
- Wire Pick (Cat. No. VDV327-103) is a professional pick/probe/spudger for precise maintenance of wires on blocks or jacks



VDV427-015-SEN



VDV427-016-SEN



VDV427-104



VDV770-050†



VDV327-103

Cat. No.	Description	Configuration End 1	Configuration End 2	Weight
VDV327-103	Wire Pick	Metal Hook End	Non-Conductive Spudger End	0.10 oz (2.8 g)
VDV427-015-SEN	110 Punchdown Blade	110 Terminate	110 Terminate and Cut	0.10 lb (0.05 kg)
VDV427-016-SEN	66 Punchdown Blade	66 Terminate	66 Terminate and Cut	0.6 oz (17 g)
VDV427-104	Dura-Blade™ 110/66 Cut Punchdown Blade	110 Terminate and Cut	66 Terminate and Cut	0.61 oz (17.3 g)
VDV770-050	WorkEnds Kit for VDV427-047	Proprietary Magnetic Hex	1/4" Female Hex	1.4 oz (40 g)

†WorkEnds™ Kit is only compatible with VDV427-047, VDV427-806 and VDV427-807.



Test & Measurement

Crafted for optimum durability, reliability and functionality, our line of test and measurement equipment is engineered with the user in mind. Designed for, and by electricians, our electrical testers provide the latest in innovative, time-saving features that professionals require.

For Professionals...
Since 1857™

Clamp Meters



	NEW CL900	CL800	CL700	CL600	NEW CL450	NEW CL380	CL312	CL210	CL110
	<ul style="list-style-type: none"> Auto-ranging True root mean square (TRMS) 2000A AC/DC current AC/DC voltage Resistance Continuity Frequency Duty cycle Capacitance Tests diodes Low Impedance (LoZ) mode Inrush Current NCVT 	<ul style="list-style-type: none"> Auto-ranging True root mean square (TRMS) 600A AC/DC current AC/DC voltage Resistance Continuity Frequency Duty cycle Capacitance Tests diodes Temperature Low Impedance (LoZ) mode NCVT 	<ul style="list-style-type: none"> Auto-ranging True root mean square (TRMS) 600A AC current AC/DC voltage Resistance Continuity Frequency Duty cycle Capacitance Tests diodes Temperature Low Impedance (LoZ) mode NCVT 	<ul style="list-style-type: none"> Auto-ranging True root mean square (TRMS) 600A AC current AC/DC voltage Resistance Continuity Tests diodes NCVT 	<ul style="list-style-type: none"> Auto-ranging True root mean square (TRMS) 600A AC current AC/DC voltage AC+DC Voltage DC Microamps Resistance Continuity Frequency Duty cycle Capacitance Tests diodes Differential Temperature Temperature Calibration Inrush Current Low Impedance (LoZ) mode Low Pass Filter NCVT 	<ul style="list-style-type: none"> Auto-ranging True root mean square (TRMS) 400A AC/DC current AC/DC voltage DC Microamps Resistance Continuity Frequency Duty cycle Capacitance Tests diodes Temperature NCVT Reverse Contrast Display 	<ul style="list-style-type: none"> Auto-ranging True root mean square (TRMS) 400A AC current AC/DC voltage DC Microamps Resistance Continuity Frequency Duty cycle Capacitance Tests diodes 	<ul style="list-style-type: none"> Auto-ranging 400A AC current AC/DC voltage Resistance Continuity Temperature 	<ul style="list-style-type: none"> Auto-ranging 400A AC current AC/DC voltage Resistance Continuity
Includes	<ul style="list-style-type: none"> Carrying Case Instruction Manual Test Leads with CATIII/CAT IV safety caps 2 x AAA Batteries 	<ul style="list-style-type: none"> Carrying Case Instruction Manual Test Leads with CATIII/CAT IV safety caps Thermocouple with adapter 2 x AAA Batteries 	<ul style="list-style-type: none"> Carrying Case Instruction Manual Test Leads with CATIII/CAT IV safety caps Thermocouple with adapter 2 x AAA Batteries 	<ul style="list-style-type: none"> Carrying Case Instruction Manual Test Leads with CATIII/CAT IV safety caps 2 x AAA Batteries 	<ul style="list-style-type: none"> Carrying Case Instruction Manual Test Leads with CATIII/CAT IV safety caps 2 Type K thermocouples 3 x AAA Batteries 	<ul style="list-style-type: none"> Carrying Case Instruction Manual Test Leads with CATIII/CAT IV safety caps Thermocouple 3 x AAA Batteries 	<ul style="list-style-type: none"> Carrying Case Instruction Manual Test Leads with CATIII/CAT IV safety caps Thermocouple 3 x AAA Batteries 	<ul style="list-style-type: none"> Carrying Case Instruction Manual Test Leads with CATIII/CAT IV safety caps Thermocouple 3 x AAA Batteries 	<ul style="list-style-type: none"> Carrying Case Instruction Manual Test Leads with CATIII/CAT IV safety caps 3 x AAA Batteries
Standards	CATIV 600 V, CATIII 1000V, CE	CATIV 600 V, CATIII 1000V, CE	CATIV 600 V, CATIII 1000V, CE	CATIV 600 V, CATIII 1000V, CE	CATIV 600 V, CATIII 1000V, CE	CATIII 600V, CE	CATIII 600V, CE	CATIII 600V, CE	CATIII 600V, CE
Law Size	2.00" (50.4 mm)	1.38" (34.9 mm)	1.38" (34.9 mm)	1.38" (34.9 mm)	2.00" (50.4 mm)	1.12" (28.6 mm)	1.12" (28.6 mm)	1.12" (28.6 mm)	1.12" (28.6 mm)
Overall Length	10.39" (263.9 mm)	9.09" (231.0 mm)	9.09" (231.0 mm)	9.09" (231.0 mm)	10.00" (254.0 mm)	8.70" (221.1 mm)	8.70" (221.1 mm)	8.70" (221.1 mm)	8.70" (221.1 mm)
Overall Width	3.90" (99.1 mm)	3.81" (96.9 mm)	3.81" (96.9 mm)	3.81" (96.9 mm)	3.77" (95.8 mm)	3.02" (76.6 mm)	3.02" (76.6 mm)	3.02" (76.6 mm)	3.02" (76.6 mm)
Overall Depth	1.70" (43.3 mm)	1.55" (39.3 mm)	1.55" (39.3 mm)	1.55" (39.3 mm)	1.59" (40.4 mm)	1.61" (40.9 mm)	1.61" (40.9 mm)	1.61" (40.9 mm)	1.61" (40.9 mm)
Weight	1.10 lb (485.0 g)	0.78 lb (350.0 g)	0.74 lb (330.0 g)	0.74 lb (330.0 g)	0.78 lb (350.0 g)	0.60 lb (270.0 g)	0.63 lb (290.0 g)	0.63 lb (290.0 g)	0.63 lb (290.0 g)



Clamp Meters

FEATURES	NEW CL900	CL800	CL700	CL600	NEW CL450	NEW CL380	CL312	CL210	CL110
Drop Protection	6.6 ft. (2 m)	6.6 ft. (2 m)	6.6 ft. (2 m)	6.6 ft. (2 m)	6.6 ft. (2 m)	6.6 ft. (2 m)	3.3 ft. (1 m)	3.3 ft. (1 m)	3.3 ft. (1 m)
Ingress Protection	IP40	IP40	IP40	IP40	-	-	-	-	-
Safety	CAT IV 600V CAT III 1000V	CAT IV 600V CAT III 1000V	CAT IV 600V CAT III 1000V	CAT IV 600V CAT III 1000V	CAT IV 600V CAT III 1000V	CAT III 600V	CAT III 600V	CAT III 600V	CAT III 600V
AC Voltage (Volts)	1000V	1000V	1000V	1000V	1000V	600V	600V	600V	600V
DC Voltage (Volts)	1000V	1000V	1000V	1000V	1000V	600V	600V	600V	600V
AC + DC Voltage	-	-	-	-	●	-	-	-	-
AC Current (Amps)	2000A	600A	600A	600A	600A	400A	400A	400A	400A
DC Current (Amps)	2000A	600A	-	-	-	400A	-	-	-
Ohms (Resistance)	60MΩ	60MΩ	60MΩ	60MΩ	60MΩ	40MΩ	40MΩ	20MΩ	20MΩ
AC Millivolts	-	-	-	-	-	●	-	●	●
DC Millivolts	●	●	●	●	●	●	●	●	●
DC Microamps	-	-	-	-	●	●	●	-	-
True RMS	●	●	●	●	●	●	●	-	-
Audible Continuity	●	●	●	●	●	●	●	●	●
Backlight	●	●	●	●	●	Reverse Contrast Display		●	●
Temperature	-	-14° – 1000°F (-26° – 538°C)	-14° – 1000°F (-26° – 538°C)	-	-40° – 1832°F (-40° – 1000°C)	-40° – 1832°F (-40° – 1000°C)	-40° – 1832°F (-40° – 1000°C)	-40° – 1832°F (-40° – 1000°C)	-
Differential Temperature	-	-	-	-	●	-	-	-	-
Digital Temperature Calibration	-	-	-	-	●	-	-	-	-
Low Impedance	●	●	●	-	●	-	-	-	-
Low-Pass Filter	-	-	-	-	●	-	-	-	-
Inrush Current	2000A	-	-	-	600A	-	-	-	-
Non-Contact Voltage Testing	●	●	●	●	●	●	-	-	-
Auto Ranging	●	●	●	●	●	●	●	●	●
Range Hold	●	●	●	●	●	●	●	●	●
Data Hold	●	●	●	●	●	●	●	●	●
Diode Test	●	●	●	●	●	●	●	-	-
Capacitance Test	6000 μF	6000 μF	6000 μF	-	6000 μF	4000 μF	4000 μF	-	-
Frequency / Duty Cycle	1Hz – 500kHz	1Hz – 500kHz	1Hz – 500kHz	-	10Hz – 1MHz	10Hz – 60kHz	10Hz – 1MHz	-	-
Max / Min	●	●	●	●	●	●	●	MAX only	MAX only
Relative Mode	-	-	-	-	●	●	-	-	-
Magnetic Mount	Available As Accessory	Available As Accessory	Available As Accessory	Available As Accessory	Available As Accessory	-	-	-	-
Worklight	-	●	-	-	-	-	-	-	-
Auto-Power Off	●	●	●	●	●	●	●	●	●
LCD Display Count	6000	6000	6000	6000	6000	4000	4000	2000	2000

















Specifications are subject to change.
See page 297 for additional information on warnings.



See warning section on page 196 for important safety information regarding clamp meters

Specialty Clamp Meters



FEATURES	NEW CL360	NEW CL150
 Drop Protection	9.8 ft. (3 m)	6.6 ft. (2 m)
 Ingress Protection	IP40	—
 Safety	Jaw & Housing CAT IV 600V CAT III 1000V Electrical & Protection Circuit CAT III 600V CAT II 1000V	CAT IV 600V CAT III 1000V
 AC Voltage (Volts)	600V	—
 DC Voltage (Volts)	1000V	—
 AC Current (Amps)	200A	3000A
 Ohms (Resistance)	60MΩ	—
 True RMS	●	●
 Audible Continuity	●	—
 Backlight	●	●
 Non-Contact Voltage Testing	●	—
 Auto Ranging	●	—
 Range Hold	—	●
 Data Hold	●	●
 Max / Min	—	●
 Auto-Power Off	●	●
 LCD Display Count	6000	3000

	NEW CL360	NEW CL150
	<ul style="list-style-type: none"> Auto-ranging True root mean square (TRMS) 200A AC current AC/DC voltage Resistance Continuity Non-Contact Voltage Testing 	<ul style="list-style-type: none"> True root mean square (TRMS) 3000A AC current Data Hold Max/Min
Includes	<ul style="list-style-type: none"> Carrying Case Instruction Manual Test Leads with CATIII/CAT IV safety caps 2 x AAA Batteries 	<ul style="list-style-type: none"> Carrying Case Instruction Manual 2 x AAA Batteries
Standards	Jaw and Housing: CATIV 600V/CATIII 1000V Electrical: CATIII 600V/CATII 1000V CE	CATIV 600V, CATIII 1000V, CE
Overall Length	8.39" (213.1 mm)	10.50" (266.7mm)
Overall Width	2.12" (53.8 mm)	4.12" (104.6 mm)
Overall Depth	1.38" (35.1 mm)	1.06" (26.9 mm)
Weight	6.40 oz (180.0g)	5.90 oz (167.0 g)



⚠ WARNINGS:

To ensure safe operation and service of the tester, follow these instructions. Failure to observe these warnings can result in severe injury or death.

- Before each use, verify meter operation by measuring a known voltage or current.
- Never use the meter on a circuit with voltages that exceed the category based rating of this meter.
- Do not use the meter during electrical storms or in wet weather.
- Do not use the meter or test leads if they appear to be damaged.
- Ensure meter leads are fully seated, and keep fingers away from the metal probe contacts when making measurements.
- Do not open the meter to replace batteries while the probes are connected.
- Use caution when working with voltages above 60V DC, or 25V AC RMS. Such voltages pose a shock hazard.
- To avoid false readings that can lead to electrical shock, replace batteries if a low battery indicator appears.
- Unless measuring voltage or current, shut off and lock out power before measuring resistance or capacitance.
- Always adhere to local and national safety codes. Use individual protective equipment to prevent shock and arc blast injury where hazardous live conductors are exposed.





Multimeters



MM700	MM600	MM400	MM300
<ul style="list-style-type: none"> Auto-ranging True root mean square (TRMS) 10A AC/DC current AC/DC voltage Resistance Continuity Frequency Duty cycle Capacitance Tests diodes Temperature Low Impedance (LoZ) mode 	<ul style="list-style-type: none"> Auto-ranging 10A AC/DC current AC/DC voltage Resistance Continuity Frequency Duty cycle Capacitance Tests diodes Temperature 	<ul style="list-style-type: none"> Auto-ranging 10A AC/DC current AC/DC voltage Resistance Continuity Frequency Duty cycle Capacitance Tests diodes Temperature 	<ul style="list-style-type: none"> Manual-ranging 10A AC current AC/DC voltage Resistance Continuity Tests diodes

Includes	MM700	MM600	MM400	MM300
	<ul style="list-style-type: none"> Instruction Manual Test Leads with CATIII/CAT IV safety caps Thermocouple with adapter Alligator Clips 2 x AAA Batteries Carrying Case 	<ul style="list-style-type: none"> Instruction Manual Test Leads with CATIII/CAT IV safety caps Thermocouple with adapter Alligator Clips 2 x AAA Batteries Carrying Case 	<ul style="list-style-type: none"> Instruction Manual Test Leads with CATIII/CAT IV safety caps Thermocouple with adapter 2 x AAA Batteries 	<ul style="list-style-type: none"> Instruction Manual Test Leads with CATIII/CAT IV safety caps 2 x AAA Batteries

Standards	MM700	MM600	MM400	MM300
	CATIV 600V, CATIII 1000V CE	CATIV 600V, CATIII 1000V CE	CAT III 600V, CE	CAT III 600V, CE

Overall Length	MM700	MM600	MM400	MM300
	7.00" (177.8 mm)	7.00" (177.8 mm)	6.00" (152.4 mm)	6.00" (152.4 mm)

Overall Width	MM700	MM600	MM400	MM300
	3.55" (90.1 mm)	3.55" (90.1 mm)	3.16" (80.4 mm)	3.16" (80.4 mm)

Overall Depth	MM700	MM600	MM400	MM300
	2.09" (53.2 mm)	2.09" (53.2 mm)	1.78" (45.2 mm)	1.78" (45.2 mm)

Weight	MM700	MM600	MM400	MM300
	0.90 lb (0.41 kg)	0.90 lb (0.41 kg)	0.51 lb (0.23 kg)	0.51 lb (0.23 kg)

FEATURES	MM700	MM600	MM400	MM300
Drop Protection	6.6 ft. (2 m)	6.6 ft. (2 m)	3.3 ft. (1 m)	3.3 ft. (1 m)
Ingress Protection	IP42	IP42	—	—
Safety	CAT IV 600V CAT III 1000V	CAT IV 600V CAT III 1000V	CAT III 600V	CAT III 600V
AC Voltage (Volts)	1000V	1000V	600V	600V
DC Voltage (Volts)	1000V	1000V	600V	600V
AC Current (Amps)	10A	10A	10A	10A
DC Current (Amps)	10A	10A	10A	—
Ohms (Resistance)	40MΩ	40MΩ	40MΩ	20MΩ
DC Millivolts	●	●	●	●
AC Milliamps	●	●	●	—
DC Milliamps	●	●	●	●
AC Microamps	●	●	●	—
DC Microamps	●	●	●	●
True RMS	●	—	—	—
Audible Continuity	●	●	●	●
Backlight	●	●	●	—
Temperature	0° – 1500°F (-18° – 816°C)	0° – 1000°F (-18° – 538°C)	0° – 1000°F (-18° – 538°C)	—
Low Impedance	●	—	—	—
Auto Ranging	●	●	●	—
Range Hold	●	●	●	—
Data Hold	●	●	●	●
Diode Test	●	●	●	●
Capacitance Test	4000 µF	1000 µF	200 µF	—
Frequency / Duty Cycle	1Hz – 500 KHz	1Hz – 500 KHz	1Hz – 50 KHz	—
Max / Min	●	●	●	—
Lead Warning	●	●	—	—
Bar Graph	●	—	—	—
Magnetic Mount	Available As Accessory	Available As Accessory	Available As Accessory	Available As Accessory
Auto-Power Off	●	●	●	—
Battery Test	—	—	—	●
LCD Display Count	4000	4000	4000	2000



Specifications are subject to change.
See page 297 for additional information on warnings.



See warning section on page 196 for important safety information regarding multimeters

Multimeter Fuses

Multimeter Replacement Fuses



69033



69191

Cat. No.	For Use With	Fuse Type
69191	MM1000, MM1300, MM2000, MM2300, MM6000	F 11A/1000V
69192	MM1000, MM1300, MM2000, MM2300, MM6000	F 440mA/1000V
69193	MM100 Fuse Kit	F10A/500V, F250mA/250V
69194	MM200 Fuse Kit	F10A/500V, F400mA/250V
69031	MM300	5x20 200MA 600V
69032	MM300, MM400	6x32 10A 600V
69033	MM400	5x20 500MA 600V
69034	MM600, MM700	10x38 10A 1000V
69035	MM600, MM700	6x32 500MA 1000V

Meter Kits

Electrical Maintenance & Test Kit

- Cat. No. RT210 detects the most common wiring problems in standard and GFCI receptacles including open ground, reverse polarity, open hot, open neutral, and hot/ground reversed
- Cat. No. 69409 Line splitter 10x allows the measuring of current draw up to 15A without splitting the load's power cord
- Cat. No. CL110 has CAT III 600V, Class 2, Double insulation safety rating and features a backlit display for clear readings
- RT210 withstands a 6.6 ft. (2 m)
- Includes a carrying case, test leads and batteries



Cat. No.	Set Contains	Weight
CL110KIT		0.94 lb (430.0 g)

Cat. No.	Overall Length	Overall Height	Overall Width	Batteries
CL110	8.70" (221.1 mm)	1.61" (40.9 mm)	3.02" (76.6 mm)	3 x AAA
RT210	1.62" (41.3 mm)	2.88" (73.0 mm)	1.88" (47.6 mm)	—
69409	4.67" (118.6 mm)	4.67" (118.6 mm)	2.28" (57.9 mm)	—



CL110KIT

Electrical Test Kit

- The MM300 multimeter was developed to withstand daily wear and tear on the job site, and has a safety rating of CAT III 600V, Class 2, Double insulation
- The NCVT-1 has a bright green LED to indicate the tester is working; it changes to red and warning tones sound when voltage is detected
- NCVT-1 has a digitally-controlled ON/OFF power button and auto power-off feature to conserve and extend battery life
- Receptacle tester detects wiring configurations and indicates correct wiring, open ground, open hot, open neutral, hot/ground reversed; it does not indicate quality of ground, multiple hot wires, or a combination of defects
- Includes visual and audible continuity indicators up to 25Ω
- Includes test leads and batteries



Cat. No.	Set Contains	Weight
69149		0.94 lb (430.0 g)

Cat. No.	Overall Length	Overall Height	Overall Width	Batteries
MM300	6.00" (152.4 mm)	1.78" (45.2 mm)	3.16" (80.4 mm)	2 x AAA
NCVT-1	5.50" (139.7 mm)	1.00" (25.4 mm)	0.72" (18.3 mm)	2 x AAA
Receptacle Tester	2.75" (69.9 mm)	1.00" (25.4 mm)	1.50" (38.1 mm)	—



69149





Meter Accessories

K-Type Temperature Pipe Clamp

- Features a temperature sensor that clamps around pipes ranging from 1/4" to 1-3/8" diameter (up to 35 mm)
- A flexible 40" (1016 mm) lead
- Works with any clamp or multimeter that measures temperature
- Includes banana plug adapter



69140

Cat. No.	Overall Length	Overall Height	Overall Width	Temperature Range	Weight
69140	5.25" (133.4 mm)	0.75" (19.1 mm)	3.00" (76.2 mm)	-4 to 212°F (-20 to 100°C)	3.13 lb (1420.0 g)

K-Type Thermocouple Probe

- Pointed tip easily pierces fiberglass ductwork for HVAC measurements
- A coiled 5 ft (1.5 m) lead
- Wide measurement range: -58 to 1112°F
- Works with any clamp or multimeter that measures temperature
- Includes banana plug adapter



69144

Cat. No.	Overall Length	Overall Height	Overall Width	Temperature Range	Weight
69144	12.50" (317.5 mm)	0.50" (12.7 mm)	0.50" (12.7 mm)	-58 to 1112°F (-50 to 600°C)	3.19 lb (1450.0 g)

Replacement K-Type Thermocouples

- UL® listed replacement thermocouple with banana plug connector 0° to 250°C (Cat. No. 69028)
- Measurement range of 0° to 250°C (Cat. No. 69435)
- Temperature measurement range of 0 to 480°C and includes banana plug adapter (Cat. No. 69142)
- Allows Type K temperature thermocouples to be used with a meter with banana plug ports (Cat. No. 69146)



69028

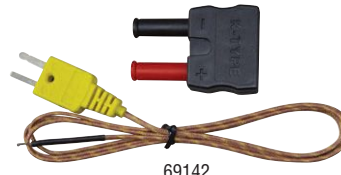

69142



69146



69435

Cat. No.	Type	For Use With	Weight
69028	K-Type Banana Thermocouple	CL200, CL210, CL310, CL312, CL330, CL700, CL1300, CL2300, MM200, MM400, MM600, MM700, MM1000, MM1300, MM2000, MM2300, MM6000	0.70 oz (19.8 g)
NEW 69435	K-Type Thermocouple	Any Clamp or Digital Multimeter that Measures Temperature	0.40 oz (11.0 g)
69142	K-Type Thermocouple, High Temperature with Adapter	Any Clamp or Digital Multimeter that Measures Temperature	0.40 oz (11.0 g)
69146	K-Type Banana Plug Adapter	Any Clamp or Digital Multimeter that Measures Temperature	0.40 oz (11.0 g)

Replacement Test Lead Set

- Safety Rating: Category IV 600V and CAT III 1000V
- Screw-on alligator clips attach to wires and other conductors
- Intended for use as replacement test leads for meters that have standard, banana-type input jacks
- Leads are 41" (1,041 mm) long
- Replacement test-lead set for all DMM, Clamp Meters, and testers
- The leads perform accurately with Klein Tools' meters and other manufacturer's meters



69410

Cat. No.	Weight
69410	0.20 lb (90.0 g)

See page 297 for additional information on warnings.



Meter Accessories

Line Splitter 10x

- Allows the measuring of current draw up to 15A without splitting the load's power cord
- For use with all Klein Tools clamp meters and other manufacture clamp meters
- Can be used to perform voltage checks with standard multimeter probes
- Provides 10X measurement mode
- For North American-style outlets only

⚠WARNINGS:

- Do NOT use with loads greater than 15A.
- Risk of electric shock and burn. Contact with live circuits could result in death or serious injury.
- Do not use if line splitter appears damaged. If in doubt, replace line splitter.
- Do NOT use line splitter if wet. For indoors use only.



69409

Cat. No.	Overall Length	Overall Height	Overall Width	Weight
69409	4.67" (118.6 mm)	4.67" (118.6 mm)	2.28" (57.9 mm)	0.24 lb (110.0 g)

Magnetic Hangers

- Durable nylon weave resists wear and tear
- Constructed with powerful rare earth magnets
- Has a secure loop & hook
- Hanger allows the user to safely work hands-free
- Cat. No. 69190 clips securely into back of rubber boot

Cat. No.	Application	For Use With	Weight
69417	Electrician's Multimeters and Select Clamps	MM300, MM400, MM600, MM700, CL450, CL600, CL700, CL800, CL900	1.10 oz (31.0 g)
69190	Electrician's Previous Generation Multimeters	MM1000, MM1300, MM2000, MM2300	1.10 oz (31.0 g)



Electrical Testers

Continuity Tester



69133

- Quickly reveals shorts or broken circuits in all types of electrical devices and controls
- Tests for continuity of circuit with power off
- Bulb in handle glows when circuit is complete (bulb included)
- Pointed 3-3/4" (95 mm) probe gets right to the problem
- Deluxe 4" (102 mm) long handle with removable nylon cap holds replaceable bulb and battery
- 36" (915 mm) test lead with alligator clip
- Uses one AAA battery (not included)
- Proudly built in U.S.A. with global components

Cat. No.	Overall Length	Weight
69133	43.75" (111.1 cm)	0.21 oz (6.0 g)
Replacement Part		
69131	Replacement Bulb for Continuity Tester Cat. No. 69133	0.05 oz (1.4 g)

Low-Voltage Tester



69127

- Device for checking live 6-24V, AC or DC circuits
- Tests for shorts in automotive and truck electrical systems, motor field coils, radio and low-voltage circuits, ground circuits of all lamps, wiring, fuses, etc.
- Bulb in handle glows when circuit is complete (bulb included)
- Pointed 3-3/4" (95 mm) probe makes checking easier
- Deluxe 3-1/2" (89 mm) long handle with nylon top holds replaceable bulb
- 36" (915 mm) test lead with alligator clip
- Proudly built in U.S.A. with global components

Cat. No.	Overall Length	Weight
69127	43.25" (109.9 cm)	0.21 oz (6.0 g)



Electrical Testers

Electronic Voltage Testers

- Cat. Nos. ET45 and ET60 do not require batteries
- Cat. Nos. ET40 and ET250 include batteries
- **ET40** is an Electronic Voltage Tester for checking or troubleshooting common residential electrical wiring and devices such as outlets, light fixtures, doorbells, batteries, etc. It tests at four useful levels for both AC (12V to 240V AC) and DC (1.5V to 24V), can identify and distinguish between AC or DC voltage, and indicates polarity when measuring DC voltages. Using 2 x AAA batteries (included), it will power off automatically after approximately 2 minutes of non-use, and has a low battery indicator. This CATIII 250V, Class 2, Double insulation safety rated tester has built-in test lead holders on sides of the tester.
- **ET45** is an Electronic Voltage Tester for checking, verifying or troubleshooting common residential electrical wiring in electrical outlets, light fixtures, doorbells, etc. It tests at four useful levels for both AC (24V to 240V AC) and DC (32V to 330V). Batteries are not required; tester is powered by the applied voltage. Built-in test leads are held in one of two positions: one so that they are spaced correctly to test tamper-resistant US-style outlets and the other for convenient storage. Built to withstand a 9.8 ft (3 m) drop, this tester has a CATIII 350V, Class 2, Double insulation safety rating.
- **ET60** is a solid-state, low impedance, electronic voltage tester that measures AC/DC voltages up to 600V. It does NOT require batteries - it is powered by the applied voltage. This tough meter design is water and dust resistant, and withstands a 9.8 ft (3 m) drop.
- **ET250** Digital AC/DC Voltage and Continuity Tester is a solid-state, digital voltage and continuity tester that measures AC/DC voltages up to 600V and tests for continuity. Additionally, the ET250 also tests GFCI protected circuits to verify that the GFCI device is functioning appropriately. This tester includes a backlight and integrated flashlight for working in reduced ambient lighting conditions. It automatically selects the measurement mode, and auto-powers on when a voltage/continuity measurement is attempted. This tough meter design is water and dust resistant, and withstands a 9.8 ft (3 m) drop.



Cat. No.	Batteries	Voltage	Standard	Overall Length	Overall Width	Weight
NEW ET40	2 x AAA	AC Level Indicators: 12V, 24V, 120V, 240V and DC indicators: 1.5V, 9V, 12V, >17-24V	CATIII 250V, CE	5.24" (133.0 mm)	1.11" (28.0 mm)	2.30 oz (66.0 g)
NEW ET45	Not Required	AC Level Indicators: 24V, 48V, 120V, 240V; DC Level indicators: 32V, 64V, 160V, 330V	CATIII 350V, CE	4.45" (113.0 mm)	1.05" (27.0 mm)	1.80 oz (52.0 g)
ET60	Not Required	12 to 600 V AC/DC	CAT IV 600V, CE	5.67" (144.1 mm)	2.84" (72.2 mm)	3.20 oz (92.00 g)
ET250	3 x AAA	2 to 600V AC/DC	CAT IV 600V, CE	6.06" (154.0 mm)	2.31" (58.8 mm)	6.00 oz (170.0 g)



See page 297 for additional information on warnings.



Electrical Testers

Non-Contact Voltage Testers

- CAT IV safety rating
- Auto power-off
- Convenient pocket clip
- Does not detect DC voltage
- **NCVT-1** provides non-contact detection of standard voltage 50 to 1000V AC in cables, cords, circuit breakers, lighting fixtures, switches, outlets and wires
- **NCVT-2** provides non-contact detection of standard voltage 12 - 1000V AC in cables, cords, circuit breakers, lighting fixtures, switches, outlets and wires. It also detects and indicates low voltage (12 to 40V AC) in security, entertainment, communications, environmental and irrigation systems
- **NCVT-3** features a flashlight, and provides non-contact detection of voltage 12 to 1000V AC with simultaneous visual and audible voltage indicators. US Patent No. D750985
- **NCVT-4IR** is designed for HVAC applications and hot spots in panels, includes an infrared thermometer with selectable °F/°C from -20 to 482°F (-30 to 250°C), LCD backlit display, and convenient laser pointer to help target 4:1 distance to spot ratio for temperature



NCVT-1



NCVT-2



NCVT-3



NCVT-4IR



Features	NCVT-1	NCVT-2	NCVT-3	NCVT-4IR
Drop Protection	9.8 ft. (3 m)	9.8 ft. (3 m)	6.6 ft. (2 m)	6.6 ft. (2 m)
Ingress Protection	IP40	IP40	IP67	IP54
Safety	CAT IV 1000V	CAT IV 1000V	CAT IV 1000V	CAT IV 1000V
Voltage	50-1000V AC	Mode 1: 12-40V AC Mode 2: 12-1000V AC	12-1000V AC	12-1000V AC
Frequency Range	50-500Hz	50-500Hz	50-500Hz	50-500Hz
Audible and Visual Alarms	●	●	●	●
Auto-Power Off	●	●	●	●
Temperature	—	—	—	-22° - 482°F (-30° - 250°C)
Laser	—	—	—	Class 2
Flashlight	—	—	●	—
Backlight	—	—	—	●
LCD Display	—	—	—	●
Batteries	2 x AAA	2 x AAA	2 x AAA	2 x AAA



Cat. No.	Voltage	Frequency	Batteries	Overall Length	Overall Height	Overall Width	Weight
NCVT-1	50 - 1000V AC	50 - 500 Hz	2 x AAA	5.50" (139.7 mm)	1.00" (25.4 mm)	0.72" (18.3 mm)	0.80 oz (22.70 g)
NCVT-2	12 - 1000V AC	50 - 500 Hz	2 x AAA	5.50" (139.7 mm)	1.00" (25.4 mm)	0.72" (18.3 mm)	0.80 oz (22.70 g)
NCVT-3	12 - 1000V AC	50 - 500 Hz	2 x AAA	5.83" (148.0 mm)	1.16" (29.4 mm)	0.72" (18.3 mm)	1.20 oz (34.00 g)
NCVT-4IR	12 - 1000V AC	50 - 500 Hz	2 x AAA	6.25" (158.8 mm)	1.25" (31.8 mm)	1.19" (30.2 mm)	2.00 oz (57.00 g)





Electrical Testers

Receptacle Testers

- Light sequence indicates correct/incorrect wiring
- Conforms to UL Std 1436, Certified to CSA Std C22.2 #160
- Operating temp: 32°F to 140°F (0°C to 40°C)
- Built to withstand a 6.6 ft. (2m) drop
- Nominal Voltage: 110/125V AC at 50/60Hz in 3-wire outlet
- Designed to detect the most common wiring problems in standard receptacles
- Cat. No. RT210 works on GFCI outlets and confirms operation of the ground fault



Cat. No.	GFCI	Overall Length	Overall Height	Overall Width	Weight
RT110	No	1.62" (41.3 mm)	2.88" (73.0 mm)	1.88" (47.6 mm)	0.12 lb (0.06 kg)
RT210	Yes	1.62" (41.3 mm)	2.88" (73.0 mm)	1.88" (47.6 mm)	0.12 lb (0.06 kg)

Digital Circuit Breaker Finder

- Quickly, accurately, and automatically find the corresponding circuit breaker of any standard 120V outlet
- For use on powered circuits only
- Does not require interruption of service
- Bright green arrow and loud beep provide clear indication of correct breaker
- Strong transmitter reaches distances up to 1000 ft. (305 m)
- Optional Circuit Breaker Finder Accessory Kit (Cat. No. 69411) shown below: Find breakers of light fixtures and bare wires with light socket and alligator clip adapters



ET300

Cat. No.	Overall Length	Overall Height	Overall Width	Weight
ET300	Receiver: 6.00" (152.4 mm); Transmitter: 2.80" (71.0 mm)	0.91" (23.0 mm)	Receiver: 2.00" (50.8 mm); Transmitter: 1.89" (48.0 mm)	0.20 lb (90.0 g)

Circuit Tester



69105

- Tests circuits rated from 80 to 600 volts AC/DC
- High-visibility neon lamp indicator
- High-impact, sealed 5-11/16" (144 mm) probe on long 24" (610 mm) leads for convenience in testing motors, fuses, relays, switches, etc.
- Resistor between each probe and lead

Cat. No.	Overall Length	Weight
69105	35.00" (889.0 mm)	0.15 lb (70.0 g)

Circuit Breaker Finder Accessory Kit



69411

- For use with ET300 Digital Circuit Breaker Finder (shown above)
- Light socket adapter for finding the corresponding circuit of a lighting fixture
- Alligator clip adapter enables use of Digital Circuit Breaker Finder on bare wires

Cat. No.	Weight
69411	0.20 lb (60.0 g)

See page 297 for additional information on warnings.



Specialty Testers

USB Digital Meters

- Accurately and reliably measures and displays the USB port voltage, current, capacity, energy and resistance simultaneously for USB-A ports (Cat. Nos. ET900 and ET910) and USB-A and USB-C ports (ET920)
- Cat. No. ET910 can also test the maximum current delivery capability of the USB port with built-in fixed loads
- Tests most common USB-A ports, including Qualcomm Quick Charge ports; Cat. No. ET920 also tests most common USB-C ports, including Qualcomm Quick Charge ports
- Stores and recalls up to 10 readings
- Voltage and current overload detection
- Hi-resolution LCD for clear visibility in environments with low ambient lighting
- Built to withstand a 6-Foot (2m) drop
- No batteries needed; powered by the USB port being tested



	Cat. No.	Voltage	Current	Capacity Used	Energy Delivered	Resistance	Elapsed Time	USB Compatibility	Overall Length	Overall Height	Overall Width	Weight
NEW	ET900	3 to 20V DC	0.05 to 3A	99,999mAh Maximum	999Wh Maximum	400 ohms Maximum	Up to 999 Hours, 59 Min, 59 Secs	USB-A; Qualcomm Quick Charge® Compatible	2.84" (72.1 mm)	0.56" (14.4 mm)	1.25" (31.8 mm)	1.10 oz (31.0 g)
NEW	ET910	3 to 20V DC	0.05 to 3A	99,999mAh Maximum	999Wh Maximum	400 ohms Maximum	Up to 999 Hours, 59 Min, 59 Secs	USB-A; Qualcomm Quick Charge® Compatible	4.31" (109.5 mm)	0.98" (24.9 mm)	2.15" (54.6 mm)	2.80 oz (79.4 g)
NEW	ET920	3 to 20V DC	USB-A: 0.05 to 3A; USB-C: 0.05-5A	99,999mAh Maximum	999Wh Maximum	400 ohms Maximum	Up to 999 Hours, 59 Min, 59 Secs	USB-A, USB-C; Qualcomm Quick Charge® Compatible	2.96" (75.2 mm)	0.60" (15.2 mm)	1.96" (49.8 mm)	1.70 oz (48.0 g)

Light Meter

- Easy-to-operate precision meter to monitor light levels and lighting retrofit projects
- Ideal for incandescent, fluorescent, metal halide, and daylight
- Measurements in foot candles (FC) and Lux
- Auto and manual range: 4000 FC; 40,000 Lux
- Features backlit LCD display with 40-segment bar graph
- Data Hold, Max/Min, and Auto Power Off
- Includes carrying pouch, instruction manual, and 9V battery



ET130

IES RECOMMENDED ILLUMINATION*			
	Location	Lux	FC
Office	Conference Room	200-750	18-70
	Office area	500-750	47-70
	Lobbies, lounges	100-200	9-18
School	Auditorium, Gymnasium	100-300	9-28
	Classroom	200-750	18-70
	Library, Drafting, Laboratory	500-1500	47-140
Hospital	Rooms	100-300	9-28
	Emergency Room	500-1000	47-93
	Operating Room	1000-2000	93-186
Factory	Packing work	150-300	14-28
	Parts assembly	1500-3000	140-280
	Inspection work	750-1500	70-140
Store	Stairs, Corridor	150-200	14-18
	Stockroom	100-300	9-28
	Merchandising	750-1500	70-140

*The Lighting Handbook 10th Edition, Illuminating Engineering Society

Cat. No.	Batteries	Overall Length	Overall Height	Overall Width	Weight
ET130	1 x 9V	8.09" (205.6 mm)	1.41" (35.7 mm)	2.09" (53.2 mm)	5.50 oz (156.0 g)





Specialty Testers

Carbon Monoxide Meter

- Easy-to-use meter detects and measures concentration levels of carbon monoxide gas in ambient air
- User protection with short-term exposure limit (STEL) alarms: low level alarm (35 ppm) and high level alarm (200 ppm)
- Backlit display with CO measurement (0 to 1000 ppm) and temperature (°F and °C)
- Auto-power off after 20 minutes of no usage helps conserve battery life
- Includes carrying pouch, instruction manual, and 4 x AAA batteries



ET110

Cat. No.	Batteries	Overall Length	Overall Height	Overall Width	Weight
ET110	4 x AAA	7.75" (196.9 mm)	1.45" (36.9 mm)	2.16" (54.8 mm)	5.10 oz (144.2 g)

Meter is not intended for use as personal protection equipment

Combustible Gas Leak Detector

- Select from two levels of sensitivity: High (50 to 1000 ppm) and Low (50 to 10,000 ppm)
- Measures methane, propane, butane, and other gases to detect for leaks
- Five red LEDs (visual) and 85db audible alerts that increase with gas concentration to detect the gas leak
- Automatic zero-point calibration at power-up
- 18 inch flexible gooseneck expands sensor's reach; clips onto device for storage
- Auto power-off after 10 minutes of non-usage conserves battery life
- Includes carrying pouch, instruction manual, and 4 x AAA batteries



ET120

Cat. No.	Batteries	Overall Length	Overall Height	Overall Width	Weight
ET120	4 x AAA	28.31" (719.2 mm)	2.75" (69.9 mm)	1.78" (45.2 mm)	13.00 oz (380.0 g)

Meter is not intended for use as personal protection equipment

See page 297 for additional information on warnings.



Thermometers

Digital Pocket Thermometers

- User selectable Fahrenheit and Celsius temperature measurements
- Backlit display for easy viewing in low light
- Max/Min, Hold and Average functions
- Auto-power off after 15 minutes conserves battery life
- FDA GRAS compliant for food usage
- Lightweight, compact tool with pocket clip provides easy storage and quick access
- Cat. No. ET05 has a range of -40 to 482° F (-40 to 250° C); Cat. No. ET10 has a range of -40 to 572° F (-40 to 300° C)



ET05



ET10

(Protective sheath positioned as handle)



- Cat. No. **ET10** features a magnet inside base of probe to easily attach to vents for hand-free IAQ (indoor air quality) measurements

Cat. No.	Batteries	Overall Length	Overall Height	Overall Width	Weight
ET05	2 x LR44	6.50" (165.1 mm)	0.94" (23.8 mm)	1.08" (27.4 mm)	1.40 oz (39.0 g)
ET10	2 x LR44	6.50" (165.1 mm)	0.97" (24.6 mm)	1.25" (31.8 mm)	1.50 oz (42.5 g)

Dual Infrared and Probe Thermometer

- Pocket tester measures temperature from -40 to 572° F (-40 to 300°C)
- Accurately measure surface temperature with infrared thermometer (DS ratio 8:1)
- Measure inside air vents and duct temperatures with temperature probe with hanging hook
- Quickly calculates differential temperature (T1-T2) for both IR and probe temperatures
- Backlit display with Hold, Max/Min, APO, and Low Battery functions
- Includes: pouch, instruction manual and 2 x AAA batteries



IR07

Cat. No.	Batteries	Overall Length	Overall Height	Overall Width	Weight
NEW IR07	2 x AAA	5.82" (147.8 mm)	0.95" (24.1 mm)	1.67" (42.4 mm)	3.60 oz (106.5 g)

Thermometers



IR10 Dual Laser Infrared Thermometer, 20:1

- Optical Resolution (Distance-to-Spot) is 20:1
- Dual targeting lasers offer more accurate determination of the area being tested
- Incorporates surface temperature measurement capability using IR emission and can also measure bulk temperatures of air, gas, or liquids using standard K-Type probe
- Measurement range for both IR and K-Type probe -40° to 1200° F (-40° to 650° C)
- Adjustable emissivity from 0.1 to 1.0 delivers flexibility to address multiple applications
- Bright backlit display for working in low ambient lighting conditions
- Statistical parameters for measurement event - max/min/avg/diff
- User definable high/low limits with audible and visual alarms when limits are breached
- Uses one 9-volt alkaline battery, with battery life expectancy at 8 hours of continuous use with laser and backlight on
- Includes custom pouch, K-Type probe and battery
- Soft-touch, over-mold housing built to withstand a 9.9' (3 m) drop
- IP54 ingress protections for dust and water resistance
- "Auto Power-Off" conserves and extends battery life
- U.S. patent D791,624



Cat. No.	Batteries	Overall Length	Overall Height	Overall Width	Weight
NEW IR10	1 x 9V	7.00" (177.8 mm)	4.49" (114.0 mm)	2.05" (52.1 mm)	7.40 oz (210.0 g)



IR5 Dual Laser Infrared Thermometer, 12:1

- Optical Resolution (Distance-to-spot) is 12:1
- Features include dual-laser targeting, auto-scan, max/min/avg/diff, high/low alarm, backlit display, auto power-off
- Drop protection to 6.6 ft. (2 m)
- Measurement Range: -22° to 752°F (-30° to 400°C)
- Uses one 9-volt battery, with battery life expectancy at 10 hours of continuous use with laser and backlight on
- Includes custom pouch and batteries
- Certified to IEC EN 61326-1:2006, EN608251:1994+A2:2001+A1:2002
- Adjustable emissivity
- Soft-touch, over-mold housing
- For ambient temperatures above freezing, the accuracy is +/- 4° F or +/- 2%; Accuracy below freezing is +/- 4° F plus 0.2 degrees per degree below 32° F



Cat. No.	Batteries	Overall Length	Overall Height	Overall Width	Weight
IR5	1 x 9V	6.82" (173.4 mm)	4.53" (115.1 mm)	1.84" (46.8 mm)	0.62 lb (0.28 kg)

See page 297 for additional information on warnings.



Borescopes

Video Borescope

- Use the Video Borescope to view inaccessible areas
- It features video, audio, photo recording, file playback, a durable camera snake with an adjustable work light, and video output capabilities
- Other features include screen rotation, adjustable LED worklight, TV-out and SD card
- IP67: Dustproof and waterproof camera
- Multiple Applications: Electrical, HVAC, Plumbing, Automotive, Aircraft. Use to view inaccessible areas: inside a wall, down the drain, in furnace or vent
- Package contents: Video Borescope, 17 mm gooseneck camera, Rechargeable lithium ion battery, Mirror camera attachment, Hook camera attachment, Magnet camera attachment, USB data & power adapter/charger, RCA composite to 3.5 mm mini A/V cable, Quick start guide, Software/instruction manual CD-ROM, Carrying case



Multiple Applications!

- Electrical
- HVAC
- Plumbing
- Automotive
- Aircraft
- Use to view inaccessible areas:
 - Inside a wall
 - Down the drain
 - In furnace or vent

ET500



Cat. No.	Overall Length	Overall Height	Overall Width	Batteries	Weight
ET500	7.00" (177.8 mm)	1.75" (44.5 mm)	3.25" (82.6 mm)	Rechargeable Lithium Ion	0.51 lb (0.23 kg)

Borescope

- Use the borescope to view inaccessible areas
- It features a durable camera snake, a high resolution screen, mirror image and an adjustable LED work light
- IP67: Dustproof and waterproof camera
- Multiple Applications: Electrical, HVAC, Plumbing, Automotive, Aircraft. Use to view inaccessible areas: inside a wall, down the drain, in furnace or vent
- Package contents: Borescope, 17 mm gooseneck camera, Rechargeable lithium ion battery, Mirror camera attachment, Hook camera attachment, Magnet camera attachment, USB data adapter/charger, USB power adapter/charger, Instruction manual



Multiple Applications!

- Electrical
- HVAC
- Plumbing
- Automotive
- Aircraft
- Use to view inaccessible areas:
 - Inside a wall
 - Down the drain
 - In furnace or vent

ET510



Cat. No.	Overall Length	Overall Height	Overall Width	Batteries	Weight
ET510	6.53" (165.9 mm)	1.55" (39.3 mm)	2.84" (72.2 mm)	Lithium-ion	0.51 lb (0.23 kg)



Borescope Accessories

6 mm Borescope Camera

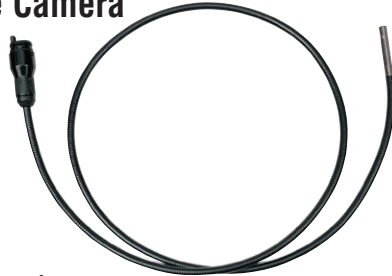

- IP67: Dustproof and waterproof camera
- Bright LED worklight
- Gooseneck design for greater control and positioning
- Smaller footprint when penetrating walls and panels

69450

Cat. No.	Overall Length	Overall Width	Weight
69450	3.28' (1.0 m)	0.23" (6.0 mm)	0.21 lb (100.0 g)
69451	6.60' (2.0 m)	0.23" (6.0 mm)	0.34 lb (160.0 g)

1 Meter Borescope Camera Extension



- Extends the reach of 17 mm and 6 mm borescope cameras
- Up to two extensions can be used with 17 mm camera without loss of video quality, to 9.9 ft. (3 m)
- Maximum of four extensions plus camera

69455

Cat. No.	Overall Length	Overall Width	Weight
69455	3.28' (1.0 m)	0.66" (17.0 mm)	0.58 lb (260.0 g)

17 mm Borescope Camera



- IP67: Dustproof and waterproof camera
- Bright LED worklight
- Gooseneck design for greater control and positioning

69454

Cat. No.	Overall Length	Overall Width	Weight
69454	3.28' (1.0 m)	0.66" (17.0 mm)	0.59 lb (270.0 g)

Borescope Attachment Tools

- Compatible with 17 mm diameter camera



69457

Cat. No.	Included	Weight
69457	1-5/8" (41.3 mm) Mirror Camera Attachment, 3" (76.2 mm) Hook Camera Attachment, 3-1/4" (82.6 mm) Magnet Camera Attachment	0.40 oz (11.3 g)

Test & Measurement Cases

Carrying Case

- Constructed of black 600 Denier Nylon
- Has a heavy-duty PVC zipper and zinc alloy zipper tag
- The case has exceptional resistance to abrasions, punctures and tears
- Easily fits the following Klein Tools test and measurement meters: MM300, MM400, MM600, MM700, CL110, CL210, CL310, CL312, CL330, CL600, CL700 and CL800
- Convenient storage for other test and measurement products

Cat. No.	Number of Pockets	Overall Length	Overall Width	Weight
69401	1	9.25" (235.0 mm)	4.00" (101.6 mm)	0.20 lb (90.0 g)



69401

See page 297 for additional information on warnings.



Cases

TRADESMAN PRO™

Tradesman Pro™ Carrying Cases

- Two layers of padding protect even delicate instruments
- Heavy-duty zipper and rugged PVC coated polyester for durability
- Pockets for quick access and organization
- Cat. No. 69406 has loop with snap closure to attach to belts, bags and backpacks
- Cat. Nos. 69407 and 69408 have sturdy handle with box stitching for secure transportation and convenient hanging
- Cat. Nos. 69406 and 69407 recommended for meters, testers, infrared guns, and small tools
- Cat. No. 69408 recommended for meters, testers, infrared guns, tools, and borescopes
- Made in the USA with global components



Cat. No.	Number of Pockets	Overall Length	Overall Height	Overall Width	Weight
69406	1	9.25" (235 mm)	2.25" (57.2 mm)	4.50" (114.3 mm)	0.38 lb (0.17 kg)
69407	2	10.25" (260.4 mm)	2.25" (57.2 mm)	6.00" (152.4 mm)	0.53 lb (0.24 kg)
69408	2	10.25" (260.4 mm)	2.25" (57.2 mm)	7.00" (177.8 mm)	0.66 lb (0.30 kg)

Tradesman Pro™ Hard Cases

- Hard shell protects tools, meters, small parts and tech devices
- Soft interior lining
- Durable zipper closure



Cat. No.	Number of Pockets	Overall Length	Overall Height	Overall Width	Weight
5184	1	8.75" (222.3 mm)	2.25" (57.2 mm)	6.50" (165.1 mm)	0.63 lb (0.29 kg)
5189	1	10.25" (260.4 mm)	2.25" (57.2 mm)	5.50" (139.7 mm)	0.63 lb (0.29 kg)



High Voltage Testers

Detect a wide range of AC voltage in overhead conductors and cables

Dual-Range High Voltage Non-Contact Tester

- Use to check for the presence of voltage in overhead conductors or to find faults in cables
- LOW range for 50V AC to 1.5kV AC
- HIGH range for 1.5kV AC to 132kV AC
- Includes durable carrying case



HVNCVT-1

Visual signal indicates presence of voltage.

Cat. No.	Overall Length	Voltage	Weight
HVNCVT-1	13.00" (330.2 mm)	Low: 50V AC - 1.5kV AC High: 1.5kV AC - 132kV AC	0.66 lb (0.30 kg)

Broad-Range Non-Contact Tester

- Use to check for the presence of voltage in overhead conductors or to find faults in cables
- 7 sensitivity ranges up to 230kV AC (240V, 4.2kV, 15kV, 25kV, 35kV, 69kV, 115kV, 230kV)
- Includes durable carrying case and universal/shotgun adapter

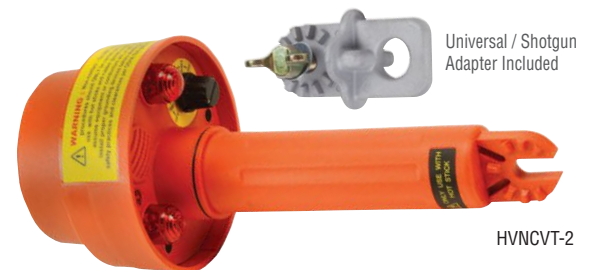

Universal / Shotgun Adapter Included

HVNCVT-2

Cat. No.	Overall Length	Voltage	Weight
HVNCVT-2	10.39" (263.9 mm)	up to 230kV AC	1.40 lb (0.60 kg)



Illumination

The Klein Tools Illumination line provides you the tools to make your life easier and more efficient on and off the jobsite. From hands-free lighting solutions such as headlamps and worklights to handheld flashlights and penlights, you can find the right tool to light your way. And as with all Klein products, you can be assured they offer the durability and reliability you know and trust.



For Professionals...
Since 1857™

Flashlight with Worklight

- Bright, focused flashlight and broadcasting work light in one tool
- Strong magnet for secure, hands-free illumination
- Glow ring tip charges while the light is on and allows for easy retrieval in the dark
- Durable; IP67 waterproof and dust proof with 10 ft. drop rating
- Aluminum body with cushion-grip handle
- Pocket clip for easy, convenient access
- 3 x AAA batteries included



56028

Charges when light is on



Glow when light turned off



Magnetic end for hands-free illumination

FL 1 STANDARD	
10ft	IP67
Flashlight	
235 Lumens	6h
Worklight	
100 Lumens	12h

Cat. No.	Lumens	Battery Life	Batteries	Drop Protection	Weight
56028	Flashlight 235; Worklight 100	Flashlight 6 hrs.; Worklight 12 hrs.	3 x AAA	10 ft (3 m)	0.34 lb (0.16 kg)

Inspection Penlight with Laser

- LED penlight for up-close lighting in dim areas
- Laser pointer aids in pinpointing objects in out-of-reach locations
- Glow ring tip charges while the light is on and allows for easy retrieval in the dark
- 10 ft. drop rating
- Pocket clip for easy, convenient access
- Aluminum body with cushion-grip handle
- 2 x AAA batteries included



56026

Charges when light is on

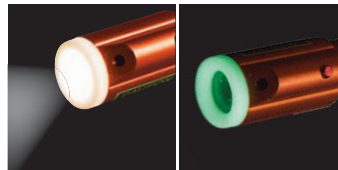

Glow when light turned off

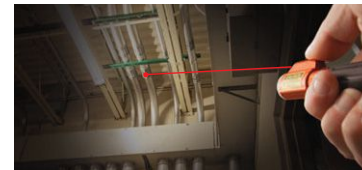

Laser pointer helps pinpoint objects

FL 1 STANDARD	
45 Lumens	10h
10ft	

Cat. No.	Lumens	Battery Life	Batteries	Drop Protection	Weight
56026	45	10 hrs.	2 x AAA	10 ft (3 m)	0.18 lb (0.08 kg)

Telescoping Magnetic LED Pickup Tool

- Telescoping extension 24" (610 mm) beyond arm's reach to retrieve magnetically-attractive tools and parts
- Powerful magnetic head with 2 lb (907 g) pickup strength
- LED light provides long-lasing illumination to guide you to and from your target
- 3" (75 mm) gooseneck end bends to aid with pickup and to work around obstacles
- Pocket clip for easy, convenient storage



56027

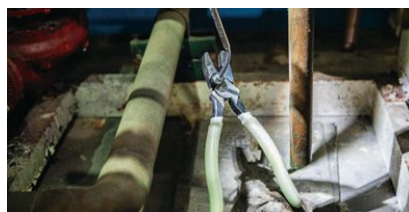

Easily locate and retrieve tools in tight spaces

FL 1 STANDARD	
25 Lumens	10h
10ft	
IP54	

Cat. No.	Lumens	Battery Life	Batteries	Drop Protection	Weight
56027	25	10 hrs.	2 x AAA Alkaline	10 ft (3 m)	6.4 oz (181.4 g)

Rechargeable Auto-Off Headlamp

- In bright light, auto-sensing technology turns headlamp off after 3 minutes to save battery
- Light can be easily removed from bracket for recharging
- Battery gauge indicates level of battery life with colored LED lights
- Slim profile with pivoting mount to allow up to a 64° lighting angle
- Silicone strap stays securely on a hardhat
- Rechargeable via micro-USB port (cable included)



56034

Easily remove from bracket for recharging



Battery gauge indicator



FL 1 STANDARD	
10ft	IP54
Spot	
200 Lumens	12h
Flood	
100 Lumens	22h

Cat. No.	Lumens	Batteries	Battery Life	Drop Protection	Weight
56034	Spot/High: 200; Flood/Low: 100	Rechargeable Internal, Li-Ion, 3.7V / 1700 mAh	Spot/High: 12 hrs.; Flood/Low: 22 hrs.	10' (3m)	3.7 oz (95.3 g)

NEW

Alkaline Headlamp

- Anti-slip silicone strap keeps headlamp securely fastened to hard hat
- Strap comes pre-adjusted for quick fit to hard hat
- 45-degree tilt for varied beam direction to point light where it is needed most
- Two modes: High (spotlight) and Low (floodlight)
- 3 x AAA batteries included



56220

Two Modes



FL 1 STANDARD	
6ft	IP54
Spotlight	
150 Lumens	6h
Floodlight	
50 Lumens	10h

Cat. No.	Lumens	Batteries	Battery Life	Drop Protection	Weight
56220	Spotlight: 150; Floodlight: 50	3 x AAA	Spotlight: 6 hrs.; Floodlight: 10 hrs	6 ft (1.8 m)	0.30 lb (0.14 kg)

Clamping Worklight

- Worklight can easily clamp to a ladder or lift
- Head rotates a full 360° and pivots up to 90° directing light wherever you need it
- Unit can stand up by itself
- Light projects in front of you, reducing shadows
- Easy to find glow head recharges when the light is on
- 4 x AAA batteries included

360° rotating pivot

90° hinge

NEW
Product

FL 1 STANDARD			
HIGH	250 Lumens	8h	LOW
	125 Lumens	10h	
10ft	✓		IP54



56029

Cat. No.	Lumens	Batteries	Battery Life	Drop Protection	Weight
NEW 56029	High: 250, Low: 125	4 x AA	High: 8 hrs., Low: 10 hrs.	10' (3 m)	15.3 oz (434 g)

Work Light

- Swivel hook and magnet for hands free use
- Three AAA batteries included
- Works with lighted tool bag Cat. No. 55431



55437

FL 1 STANDARD	
50 Lumens	5h
6ft	✓

Cat. No.	Lumens	Batteries	Battery Life	Drop Protection	Weight
55437	50	3 x AAA	5 hrs.	6 ft. (1.8 m)	0.20 lb (0.09 kg)

Clip Light

- Rugged, durable rubber overmold for safe and comfortable grip
- Hands-free options: magnetized clip for mounting to magnetic surface or clip for shirt or pocket
- Two modes: High/Low
- Impact and water resistant
- 3 x AAA batteries included



MAGNETIZED CLIP
on back of light



56221

FL 1 STANDARD	
150 Lumens	6h
10ft	✓

Cat. No.	Lumens	Batteries	Battery Life	Drop Protection	Weight
56221	High: 150, Low: 50	3 x AAA	High: 6 hrs. Low: 10 hrs.	10 ft (3 m)	0.10 lb (0.05 kg)

Sheet Metal Tools/HVAC

Klein's line of HVAC tools make it easy to work with sheet metal, ductwork and tubing. These job-matched tools are proven to stand the test of time with superior results.



For Professionals...
Since 1857™



Snips

Snips - Aviation/Bulldog/Offset **JOURNEYMAN**

- Serrated blades of forged steel for superior strength and durability
- Cuts 18 gauge steel and 22 gauge stainless steel
- Cat. Nos. J2100L, J2101R and J2102S feature exclusive Klein Kurve™ handles for natural hand positioning and ease of use
- Handles are color coded by cutting pattern
- Conforms to ASME B107.16M performance standard
- Made in USA



J2101R



J2103S



J1100L

Cat. No.	Type	Cutting Pattern	Color Code	Cutting Capacity	Cutting Length	Overall Length	Weight
J1100L	Aviation	Left/Straight	Red/Black	18 gauge steel and 22 gauge stainless steel	1.375" (34.9 mm)	9.875" (250.8 mm)	0.90 lb (0.41 kg)
J1101R	Aviation	Right/Straight	Green/Black	18 gauge steel and 22 gauge stainless steel	1.375" (34.9 mm)	9.875" (250.8 mm)	0.92 lb (0.42 kg)
J1102S	Aviation	Straight/Wide Curves	Yellow/Black	18 gauge steel and 22 gauge stainless steel	1.5" (38.1 mm)	10.063" (255.6 mm)	0.90 lb (0.41 kg)
J2103S	Bulldog	Notch/Straight	Yellow/Black	18 gauge steel and 22 gauge stainless steel	0.875" (22.2 mm)	9.438" (239.7 mm)	0.87 lb (0.39 kg)
J2100L	Offset	Left/Straight	Red/Black	18 gauge steel and 22 gauge stainless steel	1.25" (31.8 mm)	9.5" (241.3 mm)	0.97 lb (0.44 kg)
J2101R	Offset	Right/Straight	Green/Black	18 gauge steel and 22 gauge stainless steel	1.25" (31.8 mm)	9.5" (241.3 mm)	0.98 lb (0.44 kg)
J2102S	Offset	Straight/Wide Curves	Yellow/Black	18 gauge steel and 22 gauge stainless steel	1.5" (38.1 mm)	9.5" (241.3 mm)	0.97 lb (0.44 kg)

Aviation Snips with Wire Cutter

- Serrated blades of forged steel for superior strength and durability
- Unique intergrated wire cutter on outside of blade for duct and ceiling suspension wire
- Cuts 18 gauge steel and 22 gauge stainless steel
- Spring-action lock allows opening of tool with one handed operation
- Features color-coded comfortable contoured grips
- Convenient hang-hole for easy storage
- Conforms to ASME B107.16M performance standard



1201R



1202S



1200L

Cat. No.	Type	Cutting Pattern	Color Code	Cutting Capacity	Cutting Length	Overall Length	Weight
NEW 1200L	Aviation with Wire Cutter	Left/Straight	Red	18 gauge Steel and 22 gauge Stainless Steel	1.5" (38.1 mm)	10.063" (255.6 mm)	0.90 lb (0.41 kg)
NEW 1201R	Aviation with Wire Cutter	Right/Straight	Green	18 gauge Steel and 22 gauge Stainless Steel	1.5" (38.1 mm)	10.063" (255.6 mm)	0.90 lb (0.41 kg)
NEW 1202S	Aviation with Wire Cutter	Straight/Wide Curves	Yellow	18 gauge Steel and 22 gauge Stainless Steel	1.5" (38.1 mm)	10.063" (255.6 mm)	0.90 lb (0.41 kg)

See page 297 for additional information on warnings.



Sheet Metal Tools

Snap Lock Punch

- Steel jaw easily punches 3/8" (9.5 mm) wide impressions on metal edges to easily join pieces of sheet metal, duct, or siding
- Compound-leverage mechanism for greater control and easy operation
- All-steel construction and nickel-chrome plated hardware provide long life and durability
- Convenient self-opening latch for one handed operation



86528

Cat. No.	Overall Length	Handle Color	Weight
NEW 86528	8.4" (212.7 mm)	Blue/Gray	1.0 lb (0.5 kg)

Hand Notcher

- Cuts 30° V shapes in sheet metal quickly and easily to make corners
- High-impact steel jaw with 13/16" (21 mm) maximum throat depth
- All steel construction with nickel-plate and black-oxide finish provides long life and durability
- Comfortable, contoured grips cover hardened steel handles
- For up to 24 gauge steel and 28 gauge stainless steel
- Convenient self-opening latch for one handed operation



86526

Cat. No.	Overall Length	Handle Color	Weight
NEW 86526	9" (231.7 mm)	Blue/Gray	1.0 lb (0.5 kg)

5-Blade Crimper

- Produces factory-precision indentations in stove pipe and round duct with just a squeeze
- Compound-leverage mechanism makes precise indentations
- Comfortable, contoured grips cover hardened steel handles
- All steel construction and nickel-plating provide long life and durability
- Convenient self-opening latch for one handed operation
- Crimps 24 gauge steel and 28 gauge stainless steel
- Convenient self-opening latch for one handed operation



86520

Cat. No.	Overall Length	Jaw Size	Handle Color	Weight
NEW 86520	10.2" (260.3 mm)	1.75" (44.5mm)	Blue/Gray	1.0 lb (0.5 kg)

Tin Snips

- 12" long tool with high-carbon cutting blades
- Full 3.5" (89 mm) blades cut straight and wide curves
- Excellent for 24 gauge steel and 28 gauge stainless steel
- Easily cuts tin, copper, aluminum, soft metals and vinyl
- All steel construction for long life and durability
- Easily replaceable cutting blades (Cat. No. 89555)
- Largehandles to accommodate gloves



89556

Cat. No.	Cutting Capacity	Cutting Length	Overall Length	Weight
NEW 89556	24 Gauge Steel, 28 Gauge Stainless Steel	3.5" (88.9 mm)	12" (304.8 mm)	0.84 lb (0.38 kg)

Replacement Blade Kit		
Cat. No.	Overall Length	Weight
89555	4.75" (120.6 mm)	4.5 oz (127 g)





Sheet Metal Tools

Seamers - Straight and Offset

- 3" jaw folds 22 gauge steel and 24 gauge stainless steel
- Jaw marked in 1/4" (6 mm) increments for precise bending measurements
- Compound-leverage mechanism easily and accurately bends, seams, and flattens sheet metal
- All-steel construction and nickel-chrome plated hardware for long life and durability
- Convenient self-opening latch for one handed operation
- Comfortable, contoured grips cover hardened steel handles



86524



86522

	Cat. No.	Type	Overall Length	Jaw Size	Handle Color	Weight
NEW	86522	Straight	8.6" (219.1 mm)	3" (76.2 mm)	Blue/Gray	1.5 lb (0.7 kg)
NEW	86524	Offset	5.4" (136.5mm)	3" (76.2 mm)	Blue/Gray	1.5 lb (0.7 kg)

Folding Tools

- Two folding depths: 3/8" (10 mm) and 1" (25 mm)
- Handy sight gauges for accurate depth alignment
- Made of heavy-duty 16 gauge steel for strength

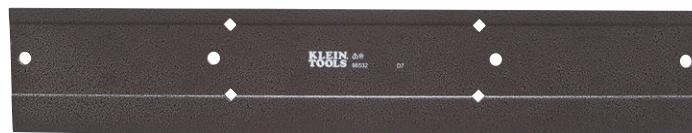

86532

	Cat. No.	Overall Length	Folds	Weight
NEW	86530	12" (305 mm)	24 ga Steel; 28 ga Stainless Steel	1.3 lb (.59 kg)
NEW	86532	18" (457 mm)	24 ga steel; 28 ga Stainless Steel	2.0 lb (0.9 kg)
NEW	86534	24" (610 mm)	24 ga Steel; 28 ga Stainless Steel	2.6 lb (1.18 kg)

Duct Tools

Duct Cutter with Wire Cutter

- All-steel double edge blade easily cuts fiber board, fiberglass lined, and flexible ducts
- Built-in wire cutter for convenience
- Compound leverage mechanism for easy wire cutting
- Comfortable, contoured grips cover hardened steel handles
- All-steel construction and nickel-chrome plated hardware provides long life and durability
- Convenient self-opening latch for one handed operation



89554

	Cat. No.	Overall Length	Weight
NEW	89554	12.5" (318.8 mm)	14.2 oz (403 g)

WARNING: Blades are intended for cutting only, and should be handled and disposed of with care. Bending the blade can cause it to break, possibly resulting in bodily injury. Check local laws on legality of selling or possessing these knives.



Duct Tools

Hole Cutter

- Cuts 2 to 12" (51 to 305 mm) holes in sheet metal
- For up to 24 gauge steel and 26 gauge stainless steel
- Inch and centimeter measurement scales are molded into the body
- Quality bearings assure a long cutting life
- Installs into standard electric drill chucks
- Includes replacement bit and L-Style Hex-Key to tighten the bit
- Features an adjustable Pivot Point for accurate hole size



89552

Cat. No.	Hole Diameter	Overall Length	Weight
NEW 89552	2" to 12"	7.2" (182.9 mm)	0.89 lb (0.4 kg)
Replacement Drill Bit			
Cat. No.	Overall Length	Weight	
89551	4.3" (109.2 mm)	0.7 oz (19.8 g)	

Duct Stretcher

- Aligns and pulls ductwork together, easing installation of drive cleats
- Offset handle protects hand



89565

Cat. No.	Overall Length	Weight
89565	16" (406.4 mm)	0.75 lb (0.34 kg)

Serrated Duct Knife

- Cuts duct board and flexible duct
- Double-edged knife: regular and serrated
- Cushion-grip handle for comfort
- Includes puncture resistant nylon sheath with belt loop



DK06

Cat. No.	Blade Length	Blade Material	Weight
DK06	5.5" (139.7 mm)	Stainless Steel	8.5 oz (241 g)

⚠WARNING: Blades are intended for cutting only, and should be handled and disposed of with care. Bending the blade can cause it to break, possibly resulting in bodily injury. **Check local laws on legality of selling or possessing these knives.**



Pipe & Tubing Tools

PVC Tube Cutter

- Handle latch keeps tool closed
- Replacement blade available (Cat. No. 88914)



88912

Cat. No.	Overall Length	Cutting Capacity	Weight
88912	7.344" (186.5 mm)	1" (25.4 mm) O.D. Multilayer Plastic Tubing and Up To 3/4" (19.1 mm) Schedule 40 PVC	7.6 oz (215 g)





Pipe & Tubing Tools

Professional Tube Cutter



88904

- Accurate 4 roller tracking system - no spiraling
- Professional reaming tool for stainless steel tubing
- Extra cutting wheel included in handle
- Replacement blade available (Cat. No. 88905)

Cat. No.	Overall Length	Cutting Capacity	Weight
88904	6.031" (153.2 mm)	1/8" to 1-3/8" (3.2 to 34.9 mm) Steel and Copper Tubing	1.3 lb (0.6 kg)

Professional Mini Tube Cutter

- Requires only 1-3/8" (35 mm) swing radius
- Perfect for tight space cutting
- Small convenient size; strong and durable tool
- Not designed for cutting stainless steel or hard tempered tubing
- Replacement blade available (Cat. No. 88905)



88910

Cat. No.	Overall Length	Cutting Capacity	Weight
88910	1.469" (37.3 mm)	1/8" to 5/8" (3.2 to 15.9 mm)	3.5 oz (99 g)

Professional 4-in-1 Tube Bender

- Bends four popular tube sizes
- Calibrated markings for accurate left-hand, right-hand, and offset bends up to 90°
- For soft copper, aluminum, and steel tubing
- Bends 3/16", 1/4", 5/16" and 3/8" (6 mm and 8 mm) O.D. tubing



89030

Cat. No.	Overall Length	Weight
89030	10" (254 mm)	1.0 lb (0.5 kg)

Professional 6-in-1 Swaging Punch

- Swages six sizes of tubing
- Hex design for ease of extraction
- Precision machined surface for ease of forming
- High-alloy steel, heat-treated for strength and durability



66400

Cat. No.	Swages	Overall Length	Weight
66400	3/16" (4.8 mm), 1/4" (6.4 mm), 5/16" (7.9 mm), 3/8" (9.5 mm), 1/2" (12.7 mm), 5/8" (15.9 mm) O.D. Tubing	5.813" (147.7 mm)	0.37 lb (0.17 kg)

Nylon Tie Tensioning Tools

Nylon Tie Tensioning Tools

- Designed for work with ties rated at 120 - 250 lbs. (54 - 113 kg)
- Tensions up to 65 lbs. of force (30 kg)
- Maximum tie width of 15/32" (12 mm)
- Handle grips for comfort
- Excess tie material is automatically cut off (Cat. No. 86571 only)



86571



86570

Cat. No.	Description	Weight
86570	Nylon Tie Tensioning Tool	0.87 lb (0.39 kg)
86571	Nylon Tie Tensioning Tool with Auto Cutoff	1.0 lb (0.5 kg)

See page 297 for additional information on warnings.



Wrenches

Adjustable Wrenches - Slim Jaw

- Designed for tight-wrench-over-wrench applications
- Jaws meet ASME 107.11-2010 testing standards for adjustable wrenches while being 40% slimmer than most standard adjustable wrench jaws
- 1-1/2" extra wide jaw capacity that is 5/16" larger than other wide-capacity 8" wrenches (Cat. No. D86936)
- Standard and metric size markings for fast adjustment
- Manufactured for strength and durability



D86936

Cat. No.	Overall Length	Handle Color	Handle Finish	Jaw Capacity	Weight
D86932	4.563" (115.9 mm)	Blue	Plastic Dipped	1/2" (12.7 mm)	2.4 oz (0.07 kg)
D86934	6.406" (162.7 mm)	Blue	Plastic Dipped	1" (25.4 mm)	0.31 lb (0.14 kg)
D86936	8.375" (212.7 mm)	Blue	Plastic Dipped	1-1/2" (38.1 mm)	0.67 lb (0.30 kg)

2-in-1 Reversible Adjustable Pipe Wrench

- Versatile 2-in-1 tool converts from adjustable wrench to pipe wrench by reversing the removable jaw
- Reversible jaw has teeth and an obtuse angle to work as a pipe wrench
- Pipe wrench side of jaw grips pipes and round fasteners with self-gripping angled teeth
- 1-1/2" extra-wide jaw opening in both configurations
- Standard and metric size markings for fast adjustment
- Meets ASME 107.11-2010 standards for adjustable wrenches



D86930

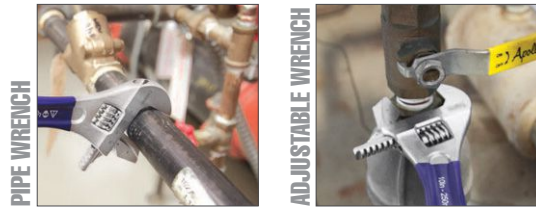

Cat. No.	Overall Length	Handle Color	Handle Finish	Jaw Capacity	Weight
D86930	10.25" (260.4 mm)	Blue	Plastic Dipped	1-1/2" (38 mm)	1.0 lb (0.5 kg)

Ratcheting Refrigeration Wrenches

- Fully reversible for refrigeration-packing gland nuts, valve stem sockets and beam-clamp installation
- Compact in size, with clearly marked sockets for four nut sizes
- Quick-flip reversing lever permits instant ratchet reversal
- Polished chrome finish for smooth edges for comfort



86938



86939

Cat. No.	Overall Length	Size	Weight
68309	6.813" (173.1 mm)	3/16" and 1/4" Sq. x 1/2" and 9/16" Hex	0.43 lb (0.20 kg)
86938	5.5" (139.7 mm)	3/16" and 5/16" Sq. x 1/4" and 3/8" Sq.	0.20 lb (0.09 kg)

Additional Items					
Cat. No.	Description	Hex Size	Connector Type	Overall Length	Weight
NEW 86939	Hex Key Adapter for Refrigeration Wrench	3/16" and 5/16"	Spring Loaded Ball Bearing	2.125" (54.0 mm)	0.7 oz (20 g)



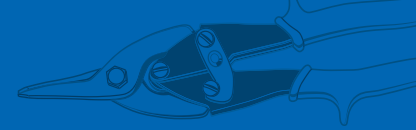

Drivers

10-in-1 Folding Screwdriver/Nut Driver *10-FOLD™*

- Conveniently folds up for easy storage or to fit into your pocket
- Each driver arm contains for interchangeable bit styles and two nut drivers
- Unfold each driver arm up to a full 180° for straight on driving power, or at 90° for extra leverage on stubborn fasteners
- The quick release button easily unlocks a fully extended driver arm



32534



Cat. No.	Nut Driver Sizes	Phillips Bits	Slotted Bits	Square Bits	Other Bits	Handle Color	Weight
32534	5/16", 1/4"	#1, #2	1/4" (6.4 mm), 3/16" (4.8 mm)	#1, #2	Schrader® Valve Insertion/Core Removal	Blue	0.37 lb (0.17 kg)

Schrader® is a registered trademark of Schrader-Bridgeport International, Inc.

11-in-1 Screwdriver/Nut Driver with Schrader® Valve Removal/Installation Bit

- Great for HVAC and other industrial applications
- Includes unique style bit for installation/removal of common TR-4 Schrader® valves and aggressive thread extractor tip for backing out broken cores



32527



Cat. No.	Nut Driver Sizes	Phillips Bits	Slotted Bits	Square Bits	Other Bits	Shank Length	Handle Color	Overall Length	Weight
32527	3/8", 5/16", 1/4"	#1, #2	1/4" (6.4 mm), 3/16" (4.8 mm)	#1, #2	Schrader® Valve Insertion/Core Removal	3" (76.2 mm)	Yellow/Black	7.75" (196.9 mm)	0.44 lb (0.20 kg)

Schrader® is a registered trademark of Schrader International, Inc.

8-in-1 HVAC Slide Driver™ Screwdriver/Nut Driver

- Unique, patented head slides back and forth to switch from 1/4" to 5/16" magnetic hex-head screwdriver
- Thumb nut locks tip setting
- Features a specialty bit for installation/removal of common TR-4 Schrader® valves
- Includes 1/4" and 3/8" hollow nut drivers, as well as #2 Phillips, 1/8" (3 mm) and 1/4" (6 mm) slotted screwdriver tips
- Great for HVAC applications including thermostat installation and control work
- U.S. patent 7,654,175 B2



32596

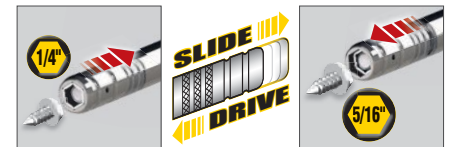

Cat. No.	Overall Length	Handle Color	Shank Length	Nut Driver Sizes	Phillips Bits	Slotted Bits	Other Bits	Weight
32596	7.5" (190.5 mm)	Yellow/Black	3.25" (82.6 mm)	1/4" Magnetic, 5/16" Magnetic, 1/4", 3/8"	#2	1/8" (3.2 mm), 1/4" (6.4 mm)	Schrader® Valve Core Removal	0.50 lb (0.2 kg)

Schrader® is a registered trademark of Schrader-Bridgeport International, Inc.

Magnetic Hex Drivers

- For driving sheet metal screws
- Strong rare earth magnets for maximum holding
- 1/4" (6.4 mm) hex shank with quick release groove



86602

Cat. No.	Description	Overall Length	Weight
86600	Magnetic Hex Drivers, 1/4", 3-Pack	1.75" (44.5 mm)	0.12 lb (0.05 kg)
86601	5/16" Magnetic Hex Drivers, 3-Pack	1.75" (44.5 mm)	0.14 lb (0.06 kg)
86602	3/8" Magnetic Hex Drivers, 3-Pack	1.75" (44.5 mm)	0.16 lb (0.07 kg)
8660010	1/4" Magnetic Hex Drivers, 10-pack	1.75" (44.5 mm)	0.43 lb (0.20 kg)
8660110	Magnetic Hex Drivers, 5/16", 10-Pack	1.75" (44.5 mm)	0.49 lb (0.22 kg)
8660210	3/8" Magnetic Hex Drivers, 10-pack	1.75" (44.5 mm)	0.57 lb (0.26 kg)

See page 297 for additional information on warnings.



Holemaking Products & Accessories

Made of top-of-the-line materials for longer lasting performance, Klein's diverse line of drill bits and holemaking products and accessories provide accuracy and consistency to get the job done right.



For Professionals...
Since 1857™

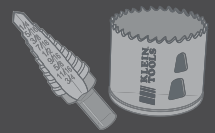

Hole Saws

Bi-Metal Hole Saws

- Optimized for cutting steel including stainless steel
- Cuts precise holes in stainless steel and mild steel, drywall, ceiling tile, laminates, wood and plastic
- Heavy-duty steel construction includes 5 mil back plate to withstand abuse
- The smallest hole saws feature hex-shaped base for easy removal from arbor



Cat. No.	Hole Diameter	Pipe Tap Size	Pipe Entrance Size	For Use With	Weight
31914	7/8" (22.2 mm)	3/4" (19.1 mm)	1/2" (12.7 mm)	31905	1.0 oz (28 g)
31918	1-1/8" (28.6 mm)	1" (25.4 mm)	3/4" (19.1 mm)	31905	1.3 oz (37 g)
31922	1-3/8" (34.9 mm)	—	1" (25.4 mm)	31905 or 31906	1.9 oz (54.4 g)
31928	1-3/4" (44.5 mm)	1-1/2" (38.1 mm)	1-1/4" (31.8 mm)	31906	1.9 oz (54.4 g)
31932	2" (50.8 mm)	—	1-1/2" (38.1 mm)	31906	2.1 oz (59.0 g)
31940	2-1/2" (63.5 mm)	—	2" (50.8 mm)	31906	2.7 oz (77.1 g)
31944	2-3/4" (69.9 mm)	—	—	31906	3.0 oz (86.2 g)
31948	3" (76.2 mm)	—	2-1/2" (63.5 mm)	31906	3.5 oz (99.8 g)
31958	3-5/8" (92.1 mm)	—	3" (76.2 mm)	31906	4.6 oz (131.5 g)
31972	4-1/2" (114.3 mm)	—	4" (101.6 mm)	31906	6.4 oz (181.4 g)
31900	6-3/8" (161.9 mm)	—	6" (152.4 mm)	31906	2.0 lb (0.9 kg)



Multiple slots provide different leverage points to easily remove material.

* Pipe Tap Size - The sizes listed provide the necessary information whenever a pipe is to be threaded into tanks, boilers, etc. To secure the best results, the hole should be reamed before tapping with a reamer having a taper of 3/4" per foot. **Pipe Entrance Size - The sizes listed provide the necessary information for any given pipe size to have sufficient clearance to pass through beams, walls, bulkheads, etc.

Hole-Saw Arbors and Accessories

- Cat. No. 31905 is for use with all Klein hole saws
- Cat. No. 31906 is for use with Klein hole saws 1-3/8" to 6-6/8" (35 mm to 162 mm)
- Fast and easy to engage and disengage hole saws
- Steel construction for long life
- 118° split point pilot bits
- 31905 includes arbor adaptor for 5/8"-18
- Hardened mandrels for long thread life



Cat. No.	Thread Length	Shank Diameter	Shank Style	Pins	Electric Drill Size	Weight
31905	1/2"-20	3/8"	Hexagonal	N	1/2" (12.7 mm) and Larger	2.6 oz (72.6 g)
31906	5/8"-18	7/16"	Hexagonal	Y	1/2" (12.7 mm) and Larger	2.6 oz (72.6 g)

Replacement Part		
Cat. No.	Description	Weight
31907	Replacement Pilot Bit, 1/4 x 3-1/2"	0.32 oz (9.1 g)

Adjustable Hole Saw

- Quickly and smoothly cuts cleaner holes in drywall and ceiling tiles
- Blades adjust to cut holes from 2" to 7" (50.8 to 177.8 mm) in diameter
- Fits most 3/8" (9.5 mm) and 1/2" (12.7 mm) drill chucks
- No binding while cutting
- No additional tools needed to adjust the hole saw
- Dust shield catches ceiling debris (2 included)
- Hex key included



Cat. No.	Range	Weight
53731	2" to 7" (50.8 to 177.8 mm)	5.0 oz (149.6 g)

See page 297 for additional information on warnings.



NOTE: Read and follow safety instructions in power tool owner's manual.

Hole Saws

Electrician's Hole Saw Kits

- Optimized teeth pattern for fast, consistent cutting of steel including stainless steel
- Cuts precise holes in stainless steel and mild steel, drywall, ceiling tile, laminates, wood and plastic
- Heavy-duty steel construction includes 5 mil back plate to withstand abuse
- Hex-shaped base for easy removal from arbor
- Contains the most popular sizes for basic electrical work
- All components are packed in a rust-proof, molded plastic carrying case

Cat. No.	Kit Contains	Weight
32905	Electrician's Hole Saw Kit with Arbor 3-Piece	2.6 lb (1.2 kg)

Cat. No.	Description
31914	Bi-Metal Hole Saw, 7/8"
31918	Bi-Metal Hole Saw, 1-1/8"
31922	Bi-Metal Hole Saw, 1-3/8"
31905	Hole Saw Arbor with Adapter, 3/8"
31907	Replacement Pilot Bit, 1/4 x 3-1/2"

Cat. No.	Kit Contains	Weight
31902	Bi-Metal Hole Saw Kit, 8-Piece	2.6 lb (1.2 kg)

Cat. No.	Description
31914	Bi-Metal Hole Saw, 7/8"
31918	Bi-Metal Hole Saw, 1-1/8"
31922	Bi-Metal Hole Saw, 1-3/8"
31928	Bi-Metal Hole Saw, 1-3/4"
31932	Bi-Metal Hole Saw, 2"
31940	Bi-Metal Hole Saw, 2-1/2"
31905	Hole Saw Arbor with Adapter, 3/8"
31906	Hole Saw Arbor With Pins, 7/16"



32905



31902

Carbide-Tipped Hole Cutters

Carbide Hole Cutters

- Cuts quick, precise holes in stainless steel, mild steel, iron, copper and brass sheet up to 3/16" (5 mm) thick
- Smooth start pilot drill bit for greater control
- Split point pilot drill bit prevents bit walking
- Integrated flange prevents the operator from drilling beyond the sheet metal
- Ejection spring for easy slug removal



31860

Cat. No.	Hole Diameter	Conduit Sizes	Weight
31850	3/4" (19.1 mm)	—	4.0 oz (113.4 g)
31852	7/8" (22.2 mm)	1/2" (12.7 mm)	4.8 oz (136.1 g)
31856	1-1/8" (28.6 mm)	3/4" (19.1 mm)	6.4 oz (181.4 g)
31860	1-3/8" (34.9 mm)	1" (25.4 mm)	7.2 oz (204.1 g)
31866	1-3/4" (44.5 mm)	1-1/4" (31.8 mm)	11.2 oz (317.5 g)
31868	2" (50.8 mm)	1-1/2" (38.1 mm)	12.8 oz (362.9 g)
31870	2-1/2" (63.5 mm)	2" (50.8 mm)	15.2 oz (430.9 g)

Replacement Part

Cat. No.	Description	Weight
31874	Replacement Hole Cutter Pilot Bit	0.80 oz (22.7 g)

4-Piece Carbide Hole Cutter Kit

- Conduit and pipe sizes: 1/2" to 1" (12.7 to 25.4 mm)
- All components are packed in a rust-proof, molded plastic carrying case



31872

Cat. No.	Set Contains	Weight
31872		1.5 lb (0.7 kg)

Cat. No.	Hole Diameter	Conduit Sizes
31852	7/8" (22.2 mm)	1/2" (12.7 mm)
31856	1-1/8" (28.6 mm)	3/4" (19.1 mm)
31860	1-3/8" (34.9 mm)	1" (25.4 mm)
31874	Pilot Bits	—



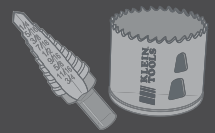

Carbide-Tipped Hole Cutters

8-Piece Master Electrician's Hole Cutter Kit

- Conduit and pipe sizes: 1/2" to 2" (12.7 to 50.8 mm)
- Includes 2 pilot bits
- All components are packed in a rust-proof, molded plastic carrying case



31873

Cat. No.	Set Contains	Weight
31873		4.3 lb (2.0 kg)
Cat. No.	Hole Diameter	Conduit Sizes
31852	7/8" (22.2 mm)	1/2" (12.7 mm)
31856	1-1/8" (28.6 mm)	3/4" (19.1 mm)
31860	1-3/8" (34.9 mm)	1" (25.4 mm)
31866	1-3/4" (44.5 mm)	1-1/4" (31.8 mm)
31868	2" (50.8 mm)	1-1/2" (38.1 mm)
31870	2-1/2" (63.5 mm)	2" (50.8 mm)
31874	Pilot Bits	—

Knockout Punches

Knockout Punch Set

- Optimized design reduces wrench effort
- Slugs are split inside for easy removal
- Maximum capacity of 10 gauge mild steel. Also cuts aluminum, fiberglass and plastic
- Punches holes cleanly and accurately
- Set includes 1/2" or 3/4" punch and die with draw stud

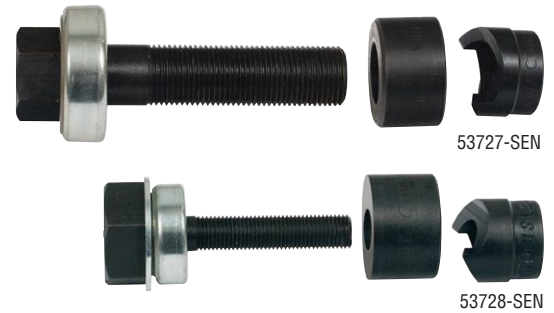

53727-SEN

53728-SEN

NOTE: Lubricate threads before each use.

Cat. No.	Conduit Sizes	Overall Length	Weight
53727SEN	3/4" (19.1 mm)	4" (101.6 mm)	0.98 lb (0.44 kg)
53728SEN	1/2" (12.7 mm)	2.625" (66.7 mm)	0.45 lb (0.20 kg)

Knockout Punch Set with Wrench

- Set includes: 1" ratcheting wrench, knockout punches, dies and draw studs for 1/2", 3/4", 1", 1-1/4", 1-1/2", and 2" conduit sizes
- Cutting capacity 10 gauge mild steel; also cuts aluminum, fiberglass and plastic
- Splits slugs for easy removal
- Punches holes cleanly and accurately
- Kit includes six different size knockout punches and dies, two draw studs and one ratcheting box end wrench



53732-SEN

NOTE: Lubricate threads before each use.

Cat. No.	Set Contains	Weight
53732SEN		9.0 lb (4.1 kg)
Cat. No.	Description	
Punch		
53819	0.875" Knockout Punch for 1/2" Conduit	
53827	1.115" Knockout Punch for 3/4" Conduit	
53837	1.362" Knockout Punch for 1" Conduit	
53849	1.701" Knockout Punch for 1-1/4" Conduit	
53857	1.951" Knockout Punch for 1-1/2" Conduit	
53867	2.416" Knockout Punch for 2" Conduit	
Die		
53820	0.875" Knockout Die for 1/2" Conduit	
53828	1.115" Knockout Die for 3/4" Conduit	
53838	1.362" Knockout Die for 1" Conduit	
53850	1.701" Knockout Die for 1-1/4" Conduit	
53858	1.951" Knockout Die for 1-1/2" Conduit	
53868	2.416" Knockout Die for 2" Conduit	
Additional Items		
53873	Ratcheting Box End Wrench, 1"	
53871	3/8" by 2-5/8" Knockout Draw Stud	
53872	Knockout Draw Stud 3/4" x 4"	

See page 297 for additional information on warnings.



NOTE: Read and follow safety instructions in power tool owner's manual.

Flexible Drill Bits

Flex Bit Augers



- Used to drill holes through wood within a wall
- Tapered back for easy bit retrieval
- Spring steel shaft resists deformation
- Screw point tip pulls the bit through wood
- Hole in tip allows for use with wire or cable pulling grip



53720

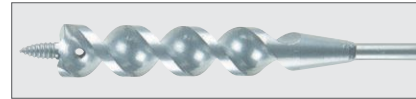

53719



53718

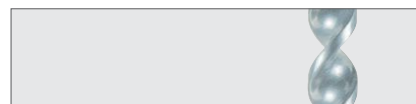

53716

Cat. No.	Bit Diameter	Overall Length	Weight
53716	3/8" (9.5 mm)	54" (137.2 cm)	1.0 lb (0.5 kg)
53717	3/8" (9.5 mm)	72" (182.9 cm)	1.0 lb (0.5 kg)
53718	9/16" (14.3 mm)	54" (137.2 cm)	1.0 lb (0.5 kg)
53719	3/4" (19.1 mm)	54" (137.2 cm)	2.0 lb (0.9 kg)
53751	3/4" (19.1 mm)	72" (182.9 cm)	2.0 lb (0.9 kg)
53720	1" (25.4 mm)	54" (137.2 cm)	2.0 lb (0.9 kg)

Flex Bit Extensions



- Connects to the end of a flex bit and extends the length

53722



Cat. No.	Connection Diameter	For Use With	Overall Length	Weight
53722	5/8" (15.9 mm)	3/4" (19.1 mm) and Larger	54" (137.2 cm)	1.0 lb (0.5 kg)
53723	7/16" (11.1 mm)	9/16" (14.3 mm) and Smaller	54" (137.2 cm)	1.0 lb (0.5 kg)

Flex Bit Kit

- 3-piece kit includes folding placement tool, 1/2"-9/16" O.D. pulling grip and 9/16" x 54" flexible drill bit
- Everything you need to pull up to 9/16" O.D. wire
- Complete kit used for drilling and pulling wire and cable
- Use placement tool (Cat. No. 53715SEN) to guide bit through walls
- Flexible drill bit (Cat. No. 53718) makes 9/16" holes in wood
- Pulling grip attaches to the flexible drill bit after the hole has been made and pulls 1/2" - 9/16" wire and cable



53721

Cat. No.	Included	Weight
53721	Flex Bit Placement Tool, Flex Drill Bit - 9/16" x 54" (14.3 x 1371.6 mm), Pulling Grip - 1/2" - 9/16" (12.7 - 14.3 mm)	2.0 lb (0.9 kg)

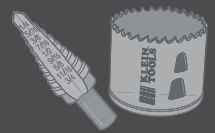

Flexible Drill Bits

Flex Bit Placement Tool

- For use with flexible drill bits
- Positions flexible drill bits horizontally or vertically within a wall
- Cushion Grip handle for non-slip comfort
- Folding design stores more compactly than standard tool



53715SEN

Cat. No.	Overall Length	Weight
53715SEN	11" (279.4 mm)	1.0 lb (0.5 kg)

Step Drill Bits

Double-Fluted High-Speed Step Drill Bits

- Two flutes cut faster and keep bit cooler
- Easy-to-read silver step rings save time when drilling common holes
- Fast-starting, non-walking drill tip
- Thick, extra-long 3/8" hex shank provides a firm, positive grip in the drill and won't spin out



High-visibility silver step rings!



Cat. No.	Quick Reference	Number of Holes	Increment	Size	Weight
KTSB01	#1	13	1/32" (0.8 mm)	1/8" to 1/2" (3.2 to 12.7 mm)	0.80 oz (22.7 g)
KTSB03	#3	9	1/16" (1.6 mm)	1/4" to 3/4" (6.4 to 19.1 mm)	0.15 lb (0.07 kg)
KTSB11	#11	2	—	7/8" to 1-1/8" (22.2 to 28.6 mm)	0.30 lb (0.14 kg)
KTSB14	#14	12	1/16" (1.6 mm)	3/16" to 7/8" (4.8 to 22.2 mm)	0.15 lb (0.07 kg)
KTSB15	#15	3	—	7/8" to 1-3/8" (22.2 to 34.9 mm)	0.46 lb (0.21 kg)

Ship-Auger Bits

Ship-Auger Bits with Screw Point

- Drills through nails, wood, vinyl, plastics and heavy timber
- Special bit steel with machine-ground flutes and polished edges for smooth, wobble-free boring
- Full length is heat-treated and tempered
- Deep, open-throat design clears chips for faster, cleaner cuts
- 7/16" hex shafts fit 1/2" and larger three-jaw chucks
- Head and twist are ground to correct clearance for easy removal from hole
- For heavy construction and repair work in mines, on docks and bridges, as well as electrical work



53437

Cat. No.	Bit Diameter	Twist Length	Overall Length	Weight
53402	3/4" (19.1 mm)	4" (101.6 mm)	6" (152.4 mm)	0.40 lb (0.18 kg)
53404	7/8" (22.2 mm)	4" (101.6 mm)	6" (152.4 mm)	0.50 lb (0.23 kg)
53406	1" (25.4 mm)	4" (101.6 mm)	6" (152.4 mm)	0.50 lb (0.23 kg)
53408	1-1/8" (28.6 mm)	4" (101.6 mm)	6" (152.4 mm)	0.80 lb (0.36 kg)
53437	3/4" (19.1 mm)	15" (381.0 mm)	18" (457.2 mm)	0.95 lb (0.43 kg)
53439	7/8" (22.2 mm)	15" (381.0 mm)	18" (457.2 mm)	1.2 lb (0.5 kg)
53441	1" (25.4 mm)	15" (381.0 mm)	18" (457.2 mm)	1.7 lb (0.8 kg)
53443	1-1/8" (28.6 mm)	15" (381.0 mm)	18" (457.2 mm)	1.8 lb (0.8 kg)

See page 297 for additional information on warnings.



NOTE: Read and follow safety instructions in power tool owner's manual.

Drill Bits



53128

Regular-Point 118° High-Speed Drill Bits

- General-purpose, high-speed bits for reliable performance in a wide range of materials
- Standard jobber length
- Black-oxide finish reduces chip welding
- Lightly roughened surface has higher lubricity for easier chip flow
- Made in USA

Cat. No.	Overall Length	Bit Diameter	Flute Length	Weight
53100	1.875" (47.6 mm)	1/16" (1.59 mm)	0.875" (22.2 mm)	0.16 oz (4.5 g)
53101	2" (50.8 mm)	5/64" (2.0 mm)	1" (25.4 mm)	0.16 oz (4.5 g)
53102	2.25" (57.2 mm)	3/32" (2.4 mm)	1.25" (31.8 mm)	0.16 oz (4.5 g)
53103	2.625" (66.7 mm)	7/64" (2.8 mm)	1.5" (38.1 mm)	0.16 oz (4.5 g)
53104	2.75" (69.9 mm)	1/8" (3.2 mm)	1.625" (41.3 mm)	0.16 oz (4.5 g)
53105	2.875" (73 mm)	9/64" (3.6 mm)	1.75" (44.5 mm)	0.16 oz (4.5 g)
53106	3.125" (79.4 mm)	5/32" (4.0 mm)	2" (50.8 mm)	0.16 oz (4.5 g)
53107	3.25" (82.6 mm)	11/64" (4.4 mm)	2.125" (54 mm)	0.16 oz (4.5 g)
53108	3.5" (88.9 mm)	3/16" (4.8 mm)	2.313" (58.8 mm)	0.32 oz (9.1 g)
53109	3.625" (92.1 mm)	13/64" (5.2 mm)	2.438" (61.9 mm)	0.32 oz (9.1 g)
53110	3.75" (95.3 mm)	7/32" (5.6 mm)	2.5" (63.5 mm)	0.80 oz (22.7 g)
53111	3.875" (98.4 mm)	15/64" (6.0 mm)	2.625" (66.7 mm)	0.80 oz (22.7 g)
53112	4" (101.6 mm)	1/4" (6.4 mm)	2.75" (69.9 mm)	0.80 oz (22.7 g)
53113	4.125" (104.8 mm)	17/64" (6.7 mm)	2.875" (73 mm)	0.80 oz (22.7 g)
53114	4.25" (108 mm)	9/32" (7.1 mm)	2.938" (74.6 mm)	0.80 oz (22.7 g)
53116	4.5" (114.3 mm)	5/16" (7.9 mm)	3.188" (81 mm)	0.80 oz (22.7 g)
53117	4.625" (117.5 mm)	21/64" (8.3 mm)	3.313" (84.2 mm)	1.6 oz (45.4 g)
53118	4.75" (120.7 mm)	11/32" (8.7 mm)	3.438" (87.3 mm)	0.80 oz (22.7 g)
53119	4.875" (123.8 mm)	23/64" (9.1 mm)	3.5" (88.9 mm)	1.6 oz (45.4 g)
53120	5" (127.0 mm)	3/8" (9.5 mm)	3.625" (92.1 mm)	1.6 oz (45.4 g)
53121	5.125" (130.2 mm)	25/64" (9.9 mm)	3.75" (95.3 mm)	1.6 oz (45.4 g)
53122	5.25" (133.4 mm)	13/32" (10.3 mm)	3.875" (98.4 mm)	2.4 oz (68.0 g)
53123	5.375" (136.5 mm)	27/64" (10.7 mm)	3.938" (100 mm)	2.4 oz (68.0 g)
53124	5.5" (139.7 mm)	7/16" (11.1 mm)	4.063" (103.2 mm)	2.4 oz (68.0 g)
53125	5.625" (142.9 mm)	29/64" (11.5 mm)	4.188" (106.4 mm)	2.9 oz (82.2 g)
53126	5.75" (146.1 mm)	15/32" (11.9 mm)	4.313" (109.6 mm)	2.4 oz (68.0 g)
53127	5.875" (149.2 mm)	31/64" (12.3 mm)	4.375" (111.1 mm)	3.2 oz (90.7 g)
53128	6" (152.4 mm)	1/2" (12.7 mm)	4.5" (114.3 mm)	3.2 oz (90.7 g)

Drill Bit Sets



53000

29-Piece Regular-Point Drill-Bit Set

- Hinged metal box with three stand-up bit holders
- General-purpose, high-speed bits for reliable performance in a wide range of materials
- Standard jobber length
- Black-oxide finish reduces chip welding
- Lightly roughened surface has higher lubricity for easier chip flow
- Made in USA

Cat. No.	Set Contains	Weight
53000		3.3 lb (1.5 kg)
Cat. No.	Bit Diameter	Flute Length
53100	1/16" (1.59 mm)	0.875" (22.2 mm)
53101	5/64" (2.0 mm)	1" (25.4 mm)
53102	3/32" (2.4 mm)	1.25" (31.8 mm)
53103	7/64" (2.8 mm)	1.5" (38.1 mm)
53104	1/8" (3.2 mm)	1.625" (41.3 mm)
53105	9/64" (3.6 mm)	1.75" (44.5 mm)
53106	5/32" (4.0 mm)	2" (50.8 mm)
53107	11/64" (4.4 mm)	2.125" (54 mm)
53108	3/16" (4.8 mm)	2.313" (58.8 mm)
53109	13/64" (5.2 mm)	2.438" (61.9 mm)
53110	7/32" (5.6 mm)	2.5" (63.5 mm)
53111	15/64" (6.0 mm)	2.625" (66.7 mm)
53112	1/4" (6.4 mm)	2.75" (69.9 mm)
53113	17/64" (6.7 mm)	2.875" (73 mm)
53114	9/32" (7.1 mm)	2.938" (74.6 mm)
53115	19/64" (7.4 mm)	3-1/16" (77.8 mm)
53116	5/16" (7.9 mm)	3.188" (81 mm)
53117	21/64" (8.3 mm)	3.313" (84.2 mm)
53118	11/32" (8.7 mm)	3.438" (87.3 mm)
53119	23/64" (9.1 mm)	3.5" (88.9 mm)
53120	3/8" (9.5 mm)	3.625" (92.1 mm)
53121	25/64" (9.9 mm)	3.75" (95.3 mm)
53122	13/32" (10.3 mm)	3.875" (98.4 mm)
53123	27/64" (10.7 mm)	3.938" (100 mm)
53124	7/16" (11.1 mm)	4.063" (103.2 mm)
53125	29/64" (11.5 mm)	4.188" (106.4 mm)
53126	15/32" (11.9 mm)	4.313" (109.6 mm)
53127	31/64" (12.3 mm)	4.375" (111.1 mm)
53128	1/2" (12.7 mm)	4.5" (114.3 mm)

Anchors

Conical Anchor Kit

- Kit contains: 100 #2 Phillips Screws, and 100 plastic anchors
- 1/4" Masonry drill bit also included



53729

Cat. No.	Anchor Size	Screw Size	Tip Size	Weight
53729	#10 - #12	#10 x 1" (25.4 mm)	1/4" (6.4 mm)	1.0 lb (0.5 kg)



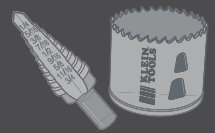

Drill Bit Sets

15-Piece Regular-Point Drill-Bit Set

- Hinged metal box with two stand-up bit holders
- General-purpose, high-speed bits for reliable performance in a wide range of materials
- Standard jobber length
- Black-oxide finish reduces chip welding
- Lightly roughened surface has higher lubricity for easier chip flow
- Made in USA



53001

Cat. No.	Set Contains	Weight
53001		2.0 lb (0.9 kg)
Cat. No.	Bit Diameter	Flute Length
53100	1/16" (1.59 mm)	0.875" (22.2 mm)
53102	3/32" (2.4 mm)	1.25" (31.8 mm)
53104	1/8" (3.2 mm)	1.625" (41.3 mm)
53106	5/32" (4.0 mm)	2" (50.8 mm)
53108	3/16" (4.8 mm)	2.313" (58.8 mm)
53110	7/32" (5.6 mm)	2.5" (63.5 mm)
53112	1/4" (6.4 mm)	2.75" (69.9 mm)
53114	9/32" (7.1 mm)	2.938" (74.6 mm)
53116	5/16" (7.9 mm)	3.188" (81 mm)
53118	11/32" (8.7 mm)	3.438" (87.3 mm)
53120	3/8" (9.5 mm)	3.625" (92.1 mm)
53122	13/32" (10.3 mm)	3.875" (98.4 mm)
53124	7/16" (11.1 mm)	4.063" (103.2 mm)
53126	15/32" (11.9 mm)	4.313" (109.6 mm)
53128	1/2" (12.7 mm)	4.5" (114.3 mm)

13-Piece Regular-Point Drill-Bit Set

- Hinged metal box with one stand-up bit holder
- General-purpose, high-speed bits for reliable performance in a wide range of materials
- Standard jobber length
- Black-oxide finish reduces chip welding
- Made in USA

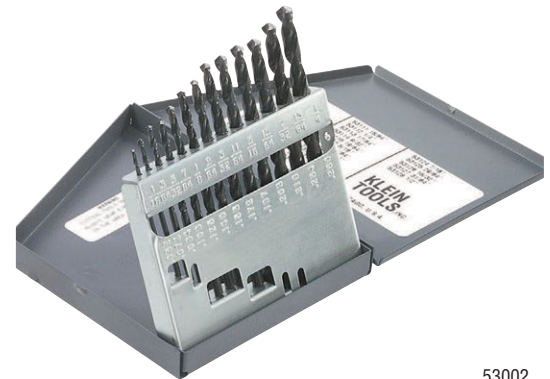

53002

Cat. No.	Set Contains	Weight
53002		0.60 lb (0.27 kg)
Cat. No.	Bit Diameter	Flute Length
53100	1/16" (1.59 mm)	0.875" (22.2 mm)
53101	5/64" (2.0 mm)	1" (25.4 mm)
53102	3/32" (2.4 mm)	1.25" (31.8 mm)
53103	7/64" (2.8 mm)	1.5" (38.1 mm)
53104	1/8" (3.2 mm)	1.625" (41.3 mm)
53105	9/64" (3.6 mm)	1.75" (44.5 mm)
53106	5/32" (4.0 mm)	2" (50.8 mm)
53107	11/64" (4.4 mm)	2.125" (54 mm)
53108	3/16" (4.8 mm)	2.313" (58.8 mm)
53109	13/64" (5.2 mm)	2.438" (61.9 mm)
53110	7/32" (5.6 mm)	2.5" (63.5 mm)
53111	15/64" (6.0 mm)	2.625" (66.7 mm)
53112	1/4" (6.4 mm)	2.75" (69.9 mm)

See page 297 for additional information on warnings.



NOTE: Read and follow safety instructions in power tool owner's manual.

Saws & Blades

Saws and blades from Klein are designed with the professional user in mind, providing superior results with less effort.



For Professionals...
Since 1857™

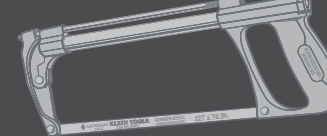

Saws & Blades

High-Tension Hacksaw

- Adjustable blade tension up to 30,000 PSI for fast, precise cuts
- Soft-touch grips
- Alternative 45° mounting for flush cutting
- Front mount for reciprocating saw blades
- Blade storage in handle
- Includes 12" x 24 TPI bi-metal hack saw blade and 6" x 24 TPI bi-metal reciprocating saw blade



702-12

Cat. No.	Blade Length	Overall Length	Weight
702-12	12" (304.8 mm)	16.25" (412.8 mm)	1.5 lb (0.7 kg)

Dual-Purpose Hacksaw - Golden Tri-Cut™ 3-in-1 Blade

- Blade has three teeth sizes
- Blade converts quickly to 90° or 45° for standard or flush-cut applications
- Pivot-lock adjusts blade tension for straighter cuts and longer blade life
- Set screw allows for storage of extra blades and secures blade for "jab" sawing
- Thumb guard for two-hand sawing
- Made in USA



701-S

Cat. No.	Blade Length	Overall Length	Weight
701-S	12" (304.8 mm)	16" (406.4 mm)	1.5 lb (0.7 kg)



Blade has three teeth sizes

Bi-Metal Blades



1224BI

- Special high-speed steel teeth fused to carbon-steel body, which provides superior cutting and longer life
- Withstands greater saw tension for less blade flexing
- Fits all 12" (305 mm) hacksaw blades
- Available in box of 100 blades or in a reclosable, heavy-vinyl, seal-tight pouch of 10 blades
- Made in USA

Cat. No.	Teeth Per Inch	Overall Length	Package Quantity	Weight
1218BI-P	18	12" (304.8 mm)	10	0.45 lb (0.20 kg)
1224BI-P	24	12" (304.8 mm)	10	0.45 lb (0.20 kg)
1232BI-P	32	12" (304.8 mm)	10	0.45 lb (0.20 kg)
1218BI	18	12" (304.8 mm)	100	4.5 lb (2.0 kg)
1224BI	24	12" (304.8 mm)	100	4.5 lb (2.0 kg)
1232BI	32	12" (304.8 mm)	100	4.5 lb (2.0 kg)

Golden Tri-Cut™ Blades



1200BI



Blade has three teeth sizes

- Unique design provides three teeth sizes on one blade
- Has 32 teeth/inch for quick starts, along with 24 teeth/inch and 18 teeth/inch for fast and smooth conventional cutting
- Special high-speed steel teeth fused to carbon-steel provide superior cutting action and long life
- Available in box of 100 blades or in a reclosable, heavy-vinyl, seal-tight pouch of ten blades
- Made in USA

Cat. No.	Teeth Per Inch	Overall Length	Package Quantity	Weight
1200BI-P	32-24-18	12" (304.8 mm)	10	0.45 lb (0.20 kg)
1200BI	32-24-18	12" (304.8 mm)	100	4.5 lb (2.0 kg)



Saws & Blades

Reciprocating Saw Blades

- Bi-metal blades offer different cutting applications of steel and wood
- Bi-metal construction for long cutting life
- Heat and wear resistant
- Shock resistant teeth resist strippage
- 1/2" universal shank to fit all popular reciprocating saw tools
- Made in USA



Cat. No.	Application	Teeth Per Inch	Blade Length	Blade Width	Blade Thickness	Package Quantity	Weight
31716	Wood with Nails	6	6" (152.4 mm)	0.75" (19.1 mm)	0.050" (1.27 mm)	5	0.23 lb (0.10 kg)
31751	Wood, Wood with Nails	6	9" (228.6 mm)	0.75" (19.1 mm)	0.05" (1.27 mm)	5	0.30 lb (0.14 kg)
31761	Wood with Nails	6	12" (304.8 mm)	0.75" (19.1 mm)	0.05" (1.27 mm)	5	0.50 lb (0.23 kg)
31731	Wood with Nails, Heavy Gauge Metals	10/14	6" (152.4 mm)	0.75" (19.1 mm)	0.050" (1.27 mm)	5	0.25 lb (0.11 kg)
31741	Wood with Nails, Heavy Gauge Metals	10/14	8" (203.2 mm)	0.75" (19.1 mm)	0.05" (1.27 mm)	5	0.40 lb (0.18 kg)
31727	Heavy Gauge Metals	14	6" (152.4 mm)	0.75" (19.1 mm)	0.035" (0.89 mm)	5	0.25 lb (0.11 kg)
31755	Heavy Gauge Metals	14	9" (228.6 mm)	1" (25.4 mm)	0.042" (1.07 mm)	5	0.50 lb (0.23 kg)
31728	Heavy Gauge Metals	18	6" (152.4 mm)	0.75" (19.1 mm)	0.035" (0.89 mm)	5	0.41 lb (0.19 kg)
31739	Heavy Gauge Metals	18	8" (203.2 mm)	0.75" (19.1 mm)	0.035" (0.89 mm)	5	0.30 lb (0.14 kg)
31734	18 Gauge and Under	24	6" (152.4 mm)	0.75" (19.1 mm)	0.035" (0.89 mm)	5	0.10 lb (0.05 kg)

NOTE: Read and follow safety instructions in power tool owner's manual.

Magic-Slot Compass Saws

- Magic-Slot design allows fast blade changing without removing thumbscrew
- Strong, lightweight, die-cast zinc handle with blue finish is contoured for comfort
- Cat. No. 703 comes with Cat. No. 706 8" blade
- Cat. No. 702 can be used with Magic-Slot cut-in or general-purpose blades only
- Made in USA



703

Cat. No.	Teeth Per Inch	Overall Length	Weight
703	10	13" (330.2 mm)	1.2 lb (0.5 kg)
Magic-Slot Compass Saw Handle			
702	702	5" (127.0 mm)	1.1 lb (0.5 kg)

Compass Saw Replacement Blades

- For cutting through wallboard or Masonite to install wiring, outlet boxes, etc.
- Tough high-quality carbon steel
- Fits Magic-Slot compass saw handle Cat. No. 702



709

Cat. No.	Teeth Per Inch	Blade Length	Weight
704	8	12" (304.8 mm)	0.14 lb (0.06 kg)
705	10	12" (304.8 mm)	0.14 lb (0.06 kg)
706	10	8" (203.2 mm)	1.4 oz (40 g)
707	10	10" (254.0 mm)	0.12 lb (0.05 kg)
709	10	4" (101.6 mm)	1.0 oz (28 g)



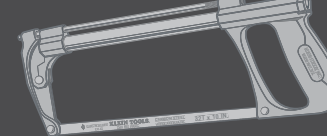

Saws & Blades

Jab Saws

- Cuts drywall, wallboard, plywood and plastic and other construction materials
- Faster cutting blade with triple ground teeth and ability to cut in both directions (push and pull)
- Folding Jab Saw (Cat. No. 31737) is as sturdy as fixed blade jab saws, with a lockback mechanism to secure the blade open at 125° and fully open at 180°
- Hardened, carbon-steel blade for durability
- Hardened, beveled blade point for scoring and plunge cuts
- Comfort cushioned grip handle
- Flat-end grip for palming or punching through drywall



725



31737

Folding Jab Saw blade securely locks at 125° and 180°



Folding Jab Saw shown closed, prevents punctures to tool bags

Cat. No.	Description	Blade Length	Overall Length	Weight
NEW 31737	Folding Jab Saw	5.2" (132.1 mm)	11.9" (302.6 mm)	0.54 lb (0.25 kg)
725	Jab Saw	6" (152.4 mm)	12" (304.8 mm)	0.31 lb (0.14 kg)



See page 297 for additional information on warnings.



Knives & Cutting Tools

Klein provides a wide range of knives, scissors and other cutting tools for professional applications across all trades.



For Professionals...
Since 1857™

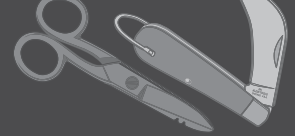

Pocket Knives

Assisted-Open Pocket Knives

- Cat. No. 44213 features a bearing-assisted opening mechanism for smooth deployment of the blade and ambidextrous flip-lever for easy one-finger opening
- Cat. No. 44223 features a spring-loaded opening mechanism for quick deployment of the blade, dual thumb studs for both left- and right-hand opening and safety lock keeps blade closed
- Low-carry pocket clip allows the knife to sit low and out of the way
- Lanyard hole for secure tethering
- Blade secures open with a frame lock (Cat. No. 44213) or a liner lock (Cat. No. 44223)



44213



44223

	Cat. No.	Blade Type	Blade Length	Blade Material	Handle Material	Length Closed	Overall Length	Weight
NEW	44213	Tanto	3.4" (86.4 mm)	420HC Stainless Steel	Stainless Steel	4.6" (117 mm)	8.0" (203.2 mm)	2.2 oz (62 g)
NEW	44223	Half-Serrated Drop Point	3.5" (88.9 mm)	440A Stainless Steel	Anodized Aluminum	4.6" (116.8 mm)	8.1" (205.7 mm)	5.3 oz (150 g)

Rugged Pocket Knives

- Liner lock secures blade in open position
- Rugged handle with rubber finger grip
- Lanyard hole allows knife to be tethered
- Low-carry pocket clip



Realtree AP-XTRA Camouflage Design
© 2012 of Jordan Outdoor Enterprises, Ltd., all rights reserved.



44220



44222

	Cat. No.	Blade Type	Blade Length	Blade Material	Handle Material	Length Closed	Overall Length	Weight
	44220	Drop Point	3.5" (88.9 mm)	440A Stainless Steel	Anodized Aluminum	4.703" (119.5 mm)	8.203" (208.4 mm)	5.0 oz (142 g)
	44222	Tanto	3.5" (88.9 mm)	440A Stainless Steel	Nylon/Rubber	4.703" (119.5 mm)	8.203" (208.4 mm)	4.0 oz (113 g)

Electrician's Pocket Knives

- Liner lock secures blade in open position
- Stripping notches on the back of the blade
- Low-carry pocket clip
- Cat. No. 44217 has a No. 2 Phillips driver



STRIPPING NOTCHES
10-14 AWG Solid and
12-16 AWG Stranded



44201



44217

	Cat. No.	Blade Type	Blade Length	Blade Material	Handle Material	Length Closed	Overall Length	Weight
	44201	Drop Point	3.375" (85.7 mm)	440A Stainless Steel	Anodized Aluminum	4.7" (119.4 mm)	7.969" (202.4 mm)	4.8 oz (136 g)
	44217	Drop Point	3.375" (85.7 mm)	440A Stainless Steel	Anodized Aluminum	4.7" (119.4 mm)	10" (254.0 mm)	7.0 oz (187 g)

See page 297 for additional information on warnings.



WARNING: Blades are intended for cutting only, and should be handled and disposed of with care. Bending the blade can cause it to break, possibly resulting in bodily injury. **Check local laws on legality of selling or possessing these knives.**

Pocket Knives

Silver Aluminum Lockback Knives

- Lockback secures blade in open position
- Reversible thumb stud for easy one-hand opening
- Cat. Nos. 44001, 44006, 44007 include removable pocket clip



44000

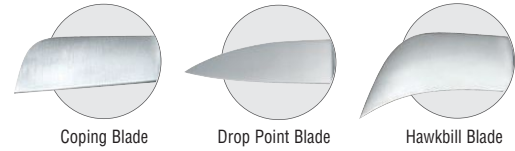

Coping Blade

Drop Point Blade

Hawkbill Blade

Cat. No.	Blade Type	Blade Length	Blade Material	Handle Material	Length Closed	Overall Length	Weight
44000	Drop Point	2.25" (57.2 mm)	AUS 8 Stainless Steel	Anodized Aluminum	3.125" (79.4 mm)	5.5" (139.7 mm)	1.5 oz (43 g)
44001	Drop Point	2.5" (63.5 mm)	AUS 8 Stainless Steel	Anodized Aluminum	3.5" (88.9 mm)	6.125" (155.6 mm)	2.6 oz (74 g)
44006	Hawkbill	2.625" (66.7 mm)	AUS 8 Stainless Steel	Anodized Aluminum	3.875" (98.4 mm)	6.625" (168.3 mm)	1.3 oz (37 g)
44007	Coping	2.5" (63.5 mm)	AUS 8 Stainless Steel	Anodized Aluminum	3.5" (88.9 mm)	6.125" (155.6 mm)	1.5 oz (43 g)

Black Aluminum Lockback Knives

- Lockback secures blade in open position
- Black stainless-steel blade and black anodized-aluminum handle
- Reversible thumb stud for easy one-hand opening
- Cat. Nos. 44001-BLK and 44052-BLK include removable pocket clip



44000-BLK

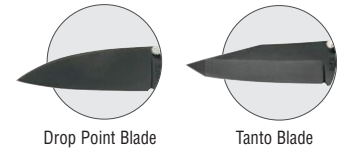

Drop Point Blade

Tanto Blade

Cat. No.	Blade Type	Blade Length	Blade Material	Handle Material	Length Closed	Overall Length	Weight
44000-BLK	Drop Point	2.25" (57.2 mm)	AUS 8 Stainless Steel	Anodized Aluminum	3.125" (79.4 mm)	5.5" (139.7 mm)	1.1 oz (31 g)
44001-BLK	Drop Point	2.5" (63.5 mm)	AUS 8 Stainless Steel	Anodized Aluminum	3.5" (88.9 mm)	6.125" (155.6 mm)	1.5 oz (43 g)
44052BLK	Tanto	2.563" (65.1 mm)	AUS 8 Stainless-Steel	Anodized Aluminum	3.5" (88.9 mm)	6.125" (155.6 mm)	4.8 oz (136 g)

Lockback Knives

- Lockback secures blade in open position
- Impact-resistant nylon resin handle with rubber insert
- Reversible thumb stud for easy one-hand opening
- Cat. Nos. 44005C and 44005RC include pocket clip



44002



44005RC

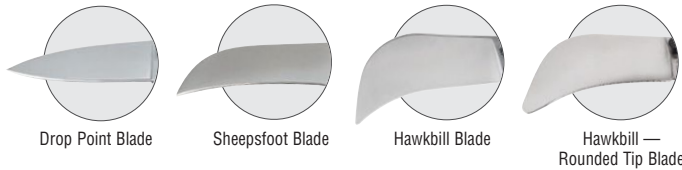

Drop Point Blade

Sheepsfoot Blade

Hawkbill Blade

Hawkbill -
Rounded Tip Blade



POCKET CLIP
AVAILABLE ON
44005C
44005RC

Cat. No.	Blade Type	Blade Length	Blade Material	Handle Material	Length Closed	Overall Length	Weight
44002	Drop Point	2.375" (60.3 mm)	AUS 8 Stainless-Steel	Nylon Resin	3.5" (88.9 mm)	6" (152.4 mm)	1.5 oz (43 g)
44003	Drop Point	2.75" (69.9 mm)	AUS 8 Stainless Steel	Nylon Resin	4.125" (104.8 mm)	7" (177.8 mm)	2.6 oz (74 g)
44004	Sheepsfoot	2.5" (63.5 mm)	AUS 8 Stainless Steel	Nylon Resin	3.5" (88.9 mm)	6" (152.4 mm)	1.5 oz (43 g)
44005	Hawkbill	2.625" (66.7 mm)	AUS 8 Stainless Steel	Nylon Resin	4.203" (106.8 mm)	6.75" (171.5 mm)	2.6 oz (74 g)
44005R	Hawkbill - Rounded Tip	2.625" (66.7 mm)	AUS 8 Stainless Steel	Nylon Resin	4.203" (106.8 mm)	6.75" (171.5 mm)	2.6 oz (74 g)
44005RC	Hawkbill - Rounded Tip	2.625" (66.7 mm)	AUS 8 Stainless Steel	Nylon Resin	4.203" (106.8 mm)	6.75" (171.5 mm)	2.6 oz (74 g)
44005C	Hawkbill with Clip	2.625" (66.7 mm)	AUS 8 Stainless Steel	Nylon Resin	4.203" (106.8 mm)	6.75" (171.5 mm)	2.2 oz (62.4 g)



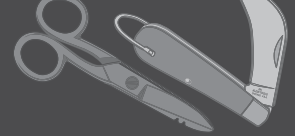

Pocket Knives

Compact Pocket Knife

- Lockback secures blade in open position
- Corrosion resistant black aluminum handle
- Reversible thumb stud for easy one-hand opening
- Lanyard hole allows knife to be tethered
- Low-carry pocket clip



44142

Cat. No.	Blade Type	Blade Length	Blade Material	Handle Material	Length Closed	Overall Length	Weight
44142	Drop Point	2.875" (73 mm)	440A Stainless Steel	Aluminum	3.8" (96.5 mm)	6.75" (171.5 mm)	0.14 oz (4.0 g)

Stainless Steel Compact Knives

- Lockback secures blade in open position
- High-grade stainless steel handle with rosewood inlay
- Lightweight and compact



44032

Cat. No.	Blade Type	Blade Length	Blade Material	Handle Material	Length Closed	Overall Length	Weight
44032	Drop Point	1.625" (41.3 mm)	Stainless Steel	Stainless Steel	2.406" (61.1 mm)	4.25" (108 mm)	1.0 oz (28 g)
44033	Drop Point	2.25" (57.2 mm)	Stainless Steel	Stainless Steel	3" (76.2 mm)	5.25" (133.4 mm)	1.8 oz (51 g)
44034	Drop Point	3" (76.2 mm)	Stainless Steel	Stainless Steel	4" (101.6 mm)	7" (177.8 mm)	4.0 oz (113 g)

Wood Grain Handle Pocket Knives

- Liner lock secures blade in open position
- Durable plastic handle with faux wood grain
- Shackle allows knife to be tethered



1550-4



1550-11



1550-44

Cat. No.	Blade Type	Blade Length	Blade Material	Handle Material	Length Closed	Overall Length	Weight
1550-4	Hawkbill	2.625" (66.7 mm)	Carbon Steel	Plastic	4.141" (105.2 mm)	6.125" (155.6 mm)	4.0 oz (113 g)
1550-11	Coping	2.25" (57.2 mm)	Carbon Steel	Plastic	3.25" (82.6 mm)	5.5" (139.7 mm)	1.5 oz (43 g)
1550-44	Hawkbill	2.625" (66.7 mm)	Stainless Steel	Plastic	3.5" (88.9 mm)	6.125" (155.6 mm)	4.0 oz (113 g)

Slitting Pocket Knife

- Liner lock secures blade in open position
- Durable plastic handle
- Shackle allows knife to be tethered



1550-24

Cat. No.	Blade Type	Blade Length	Blade Material	Handle Material	Length Closed	Overall Length	Weight
1550-24	Hawkbill	2.75" (69.9 mm)	Stainless Steel	Plastic	4.5" (114.3 mm)	6.75" (171.5 mm)	2.6 oz (74 g)

See page 297 for additional information on warnings.



WARNING: Blades are intended for cutting only, and should be handled and disposed of with care. Bending the blade can cause it to break, possibly resulting in bodily injury. **Check local laws on legality of selling or possessing these knives.**

Pocket Knives

Sportsman Knives

- Lockback secures blade in open position
- Wood handle with brass holsters
- Cat. No. 44037 has a leather case with belt loop



44037

Cat. No.	Blade Type	Blade Length	Blade Material	Handle Material	Length Closed	Overall Length	Weight
44036	Clip Point	2.625" (66.7 mm)	Stainless Steel	Ebony Wood	3.75" (95.3 mm)	6.375" (161.9 mm)	2.6 oz (74 g)
44037	Clip Point	3.375" (85.7 mm)	Stainless Steel	Ebony Wood	5" (127.0 mm)	8.75" (222.3 mm)	6.6 oz (187 g)

Pocket Knives – Multi-Blade

2-Blade Pocket Knife - Spearpoint and Screwdriver-Tip Blades

- Standard spearpoint blade - 2-1/2" (63.5 mm) long
- Screwdriver-tip blade - 2-1/2" (63.5 mm) long
- Screwdriver-tip blade locks open



1550-2

Cat. No.	Blade Length	Material	Length Closed	Overall Length	Weight
1550-2	2.5" (63.5 mm)	Carbon Steel	3.75" (95.3 mm)	6.625" (168.3 mm)	4.0 oz (113 g)

3-Blade Pocket Knife - Sheepsfoot, Spearpoint and Screwdriver-Tip Blades

- Curved sheepsfoot skinning blade - 2-3/8" (60 mm) long
- Standard spearpoint blade - 2-1/2" (64 mm) long
- Screwdriver-tip blade - 2-1/2" (64 mm) long
- Screwdriver blade locks open



1550-6

Cat. No.	Blade Length	Material	Length Closed	Overall Length	Weight
1550-6	2.375" (60.3 mm), 2.5" (63.5 mm)	Carbon Steel	3.75" (95.3 mm)	6.5" (165.1 mm)	5.0 oz (142 g)

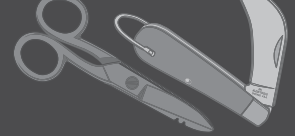

Pocket Knives – Multi-Tool

Hybrid Pliers Multi-Tool

- Includes: hybrid pliers, wire cutter, wire stripper, pocket knife, No. 2 Phillips screwdriver, slotted screwdriver, metal splinter remover
- Features a wide, knurled plier head to easily grab and twist wires
- Strips 10-14 AWG solid and 12-16 AWG stranded wire
- 3" (76 mm) drop point knife blade is accessible without opening the tool
- Both the slotted driver and No. 2 Phillips driver tuck neatly in the handle
- Liner lock keeps knife blade securely in the open position
- Metal splinter remover stores in the durable aluminum handle
- Seven (7) most used functions in one compact everyday-carry multi-tool
- Fits with Knife Holder Cat. No. 5248



44216

Cat. No.	Blade Length	Material	Length Closed	Overall Length	Weight
NEW 44216	3" (76.2 mm)	Stainless Steel and Aluminum	4.5" (114.3 mm)	7.3" (185.4 mm)	12.1 oz (343 g)

Trip-Saver™ Multi-Tool

- Unique multi-tool addresses the special needs of electricians and maintenance professionals while providing many other features handy on any job
- Specially designed locking "L" handle snaps securely into the "L" channel, locking the fully opened blade or implement in place during use
- Features the following: Needle-Nose Pliers, Beveled Wire Cutter, Toothed Pipe Grippers, Files (coarse and fine), 5-Slot Wire Stripper (10-18 AWG), Wire-Looping Hole, Scraper, Awl/Reamer, Serrated Sheepfoot Knife, Clip-Point Knife, Standard/Metric Ruler, Drywall Saw, Locking "L" Handle, #1 and #2 Phillips Hex Bits, Small-Slotted Hex Bit, Large-Slotted Hex Bit, 1/4" Socket Adapter, Lanyard Hole, Nylon Pouch



1016

⚠WARNING: Close handles to lock blade in place before use.

Cat. No.	Blade Length	Material	Length Closed	Overall Length	Weight
1016	1.875" (47.6 mm); 2.5" (63.5 mm)	Stainless Steel	5.75" (146.1 mm)	5.75" (146.1 mm)	15.2 oz (431 g)

Utility Knives

Camouflage Assisted-Open Folding Utility Knife

- Realtree Xtra® Camo design handle with rubber grip and TPR overmold for a secure grip
- Rugged, heavy-duty and durable construction
- Spring-assisted opening with dual thumb stud for right- or left-handed use
- Blade locks when in closed position
- Low carry pocket clip
- Lanyard hole



44135

Cat. No.	Overall Length	Length Closed	Weight
44135	7" (177.8 mm)	6.25" (158.8 mm)	7.5 oz (213 g)



Realtree AP-XTRA Camouflage Design
© 2012 of Jordan Outdoor Enterprises, Ltd., all rights reserved.

See page 297 for additional information on warnings.



⚠WARNING: Blades are intended for cutting only, and should be handled and disposed of with care. Bending the blade can cause it to break, possibly resulting in bodily injury. **Check local laws on legality of selling or possessing these knives.**

241

Utility Knives

Folding Utility Knife

- Push button to easily open and close
- Rugged, heavy-duty and durable construction
- Contains a wire stripping notch
- High quality triple ground blades stay sharp longer
- Rubber grips on handle for improved control and comfort
- The bright orange handle color makes this knife easy to find in a tool bag or pouch



44131

Cat. No.	Overall Length	Length Closed	Weight
44131	6.25" (158.8 mm)	4" (101.6 mm)	4.3 oz (122 g)

Auto-Loading Folding Retractable Utility Knife

- Auto-loading blade for faster and safer blade changes
- Internal blade storage holds and includes 3 blades
- Rubber grips on handle for improved control and comfort
- High quality triple ground blades stay sharp longer
- Lock release to close knife
- Equipped with belt clip



44130



Cat. No.	Overall Length	Length Closed	Weight
44130	7.125" (181 mm)	4.125" (104.8 mm)	7.5 oz (213 g)

Auto-Retracting Utility Knife

- Rugged, heavy-duty and durable construction
- Knife incorporates a wire-stripping notch
- Safety yellow handle for greater visibility
- Blade removal/insertion without disassembly
- Blade retracts fully into housing when cut is complete



44136

Blade retracts fully into housing when cut is complete.



Cat. No.	Overall Length	Length Closed	Weight
44136	5.75" (146.1 mm)	5.672" (144.1 mm)	7.0 oz (187 g)

Klein Kurve™ Retractable Utility Knife

- Rugged, heavy-duty and durable construction
- Contains a wire-stripping notch
- Internal blade storage includes and holds 6 blades
- High quality triple ground blades stay sharp longer
- Rubber grips on handle for improved control and comfort
- Designed for improved cutting ability



44133

Cat. No.	Overall Length	Length Closed	Weight
44133	7" (177.8 mm)	6.5" (165.1 mm)	7.5 oz (213 g)

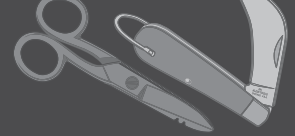

Utility Knives

Utility Knife - Retractable Blade

- Top button moves heavy-duty, razor-edged blade to any of three cutting positions
- Double-ended, reversible blade retracts fully for carrying
- Lightweight aluminum handle is shaped for comfort
- Accepts most standard blades
- Includes three standard blades, stored in handle
- Leather holder available, Cat. No. 5185



44100

Cat. No.	Overall Length	Length Closed	Weight
44100	6.625" (168.3 mm)	6" (152.4 mm)	3.5 oz (99 g)

Utility Knife Blade Dispenser

- 50 blades included
- High quality triple ground blades stay sharp longer
- Gauge on dispenser indicates blades remaining
- Convenient interim storage for used blades
- Blades are compatible with all standard utility knives



44103

Cat. No.	Overall Width	Dimensions	Weight
44103	1.297" (32.9 mm)	4-21/64" x 2-51/64" x 1-19/64" (109.9 x 71.0 x 32.9 mm)	1.0 lb (0.45 kg)

Utility Knife Blades

- Heavy-duty razor-edged blades
- Universal size fits Klein and most other makes of utility knives
- Blades are reversible for extra life
- Blades made in the U.S.A.

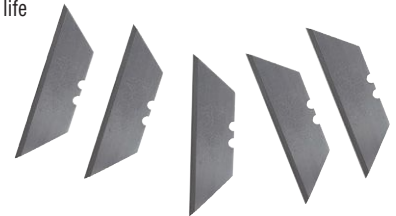

44101

Cat. No.	Blade Length	Blade Thickness	Package Quantity	Weight
44101	2.438" (61.9 mm)	0.025" (0.6 mm)	5	0.8 oz (23 g)

Cable Knives

Cable Skinning Utility Knife with Replaceable Blade

- Heavy-duty sheepsfoot blade is replaceable to eliminate the need for sharpening
- Blade locks securely by a captive lock screw, making it as solid as a fixed-blade knife
- Thumb stud for easy opening
- Handle has rubber exterior for increased grip
- A lock-back design securely locks the blade in the open position
- Pocket clip for easy storage and convenient access
- Replacement blades available in pack of 3 (Cat. No. 44219)



44218

Cat. No.	Special Features	Blade Length	Overall Length	Blade Material	Handle Color	Weight
44218	Replaceable Blade Knife	2.5" (63.5 mm)	7.797" (198 mm)	440A Stainless Steel	Orange/Black	5.8 oz (164 g)

Replacement Blades

Cat. No.	Blade Length	Blade Type	Package Quantity	Weight
44219	2.5" (63.5 mm)	Hawkbill	3	0.5 oz (14.1 g)
44138	2.0" (49.2 mm)	Coping	3	1.6 oz (45 g)

See page 297 for additional information on warnings.



WARNING: Blades are intended for cutting only, and should be handled and disposed of with care. Bending the blade can cause it to break, possibly resulting in bodily injury. **Check local laws on legality of selling or possessing these knives.**

Cable Knives

Cable/Lineman's Skinning Knives

- Cat. Nos. 1570-3 and 1570-3LR feature three-inch steel blades that withstand frequent scoring and slitting of cable jacket
- Notch on blade back for scraping or removing wire insulation
- Comfortable textured handle with finger grooves and guard
- No contact between stainless steel ring and hardened steel blade (Cat. No. 1570-3)
- Rectangle-shaped handle design for attachment to some utility hot stick equipment
- Leather sheath available, Cat. No. 5163 only for Cat. Nos. 1570-3 and 1570-3LR
- Cat. No. 1580-3 has a 2" (50.8 mm) blade for increased control when scoring and slitting cable jacket and an ergonomic handle for maximum comfort



Cat. No.	Special Features	Blade Length	Overall Length	Blade Material	Handle Color	Weight
1570-3	Hook Blade, Notch, and Ring	3" (76.2 mm)	8" (203.2 mm)	Steel	Black	4.8 oz (136 g)
1570-3LR	Hook Blade and Notch	3" (76.2 mm)	8" (203.2 mm)	Steel	Black	4.6 oz (130 g)
1580-3	Hook Blade, Notch, and Ring	2.047" (52 mm)	8.75" (222.3 mm)	Steel	Black	4.5 oz (128 g)

Cable-Sheath Splitting Knife

- Compact, lightweight knife for opening lead cables
- Rugged, forged tempered cutlery steel blade
- Sharp chisel-shaped edge
- Hammer head on back
- Plastic-dipped handles for comfort
- Leather guard available, Cat. No. 5574S



Cat. No.	Blade Length	Overall Length	Weight
1515-S	2.75" (69.9 mm)	7.375" (187.3 mm)	0.35 lb (0.16 kg)

Bell System Cable-Sheath Splitting Knife - Heavy-Duty

- Heavy-duty knife for splitting cable sheaths
- Rugged, forged tempered cutlery steel blade
- Sharp chisel-shaped edge
- Plastic-dipped handles for comfort
- Leather guard available, Cat. No. 5574L



Cat. No.	Blade Length	Overall Length	Weight
1515-1	4.5" (114.3 mm)	9" (228.6 mm)	1.2 lb (0.5 kg)



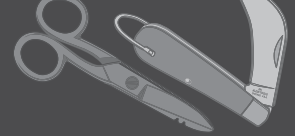

Cable Knives

Cable-Splicer's Knife

- Special-purpose short blade with comfortable, full-sized, heavy-duty handle
- Coping-type blade made of the finest cutlery steel, tough and carefully tempered to hold its edge
- Handle is textured for comfort and firm grip
- Hang hole for easy storage and portability



44200

Cat. No.	Blade Length	Overall Length	Weight
44200	1.75" (44.5 mm)	6.25" (158.8 mm)	0.15 lb (0.07 kg)

Cable-Splicer's Kits

- Cuts cable, telephone wire, and strips insulation
- Dimensions: 2-1/8" (54 mm) x 7-1/2" (190.5 mm)

Cat. No.	Kit Contains	Weight
46037	Cable Splicer's Kit	8.0 oz (227 g)
Cat. No.	Description	
44200	Cable Splicer's Knife, 6-1/2"	
2100-7	Electrician's Scissors, Nickel Plated	
5187	Scissors and Cable Splicer's Knife Holder	
Cat. No.	Kit Contains	Weight
46039	Cable Splicer's Kit with Free-Fall Snip	9.3 oz (264 g)
Cat. No.	Description	
44200	Cable Splicer's Knife, 6-1/2"	
21010	Free-Fall Snip	
5187	Scissors and Cable Splicer's Knife Holder	



46037

46039

Specialty Knife

Serrated Duct Knife

- Cuts duct board and flexible duct.
- Double-edged knife - regular and serrated.
- Cushion-grip handle for comfort.
- Includes puncture resistant nylon sheath with belt loop.



DK06

Cat. No.	Blade Length	Blade Material	Weight
DK06	5.5" (139.7 mm)	Stainless Steel	8.5 oz (241 g)

See page 297 for additional information on warnings.



WARNING: Blades are intended for cutting only, and should be handled and disposed of with care. Bending the blade can cause it to break, possibly resulting in bodily injury. **Check local laws on legality of selling or possessing these knives.**

Sharpening Tools

Pocket-Sized Knife Sharpener

- Versatile sharpener featuring fine craftsmanship and unique design
- Sharpening rod unscrews and stores in handle for convenient carrying in tool box, pouch, or pocket
- Sharpening rod is precision-cut, hard-chromed steel for accurate, consistent sharpening and long life
- Magnetized to trap metal particles when sharpening
- Handle is a high-visibility orange color with handy pocket clip

PRODUCT SHOWN CLOSED



PRODUCT SHOWN OPEN

44151

Cat. No.	Blade Length	Overall Length	Overall Width	Blade Material	Handle Length	Weight
44151	3.75" (95.3 mm)	9.5" (241.3 mm)	0.5" (12.7 mm)	Steel	5.5" (139.7 mm)	0.80 oz (22.7 g)

Combination Knife and Scissors Sharpener

- High-grade, tungsten-carbide inserts sharpen both sides of the blade at the same time
- Restores knife edge in three or four strokes
- Built-in finger guard helps to protect your hand
- Lightweight, compact size for easy carrying and storage
- Sharpens electrician's scissors, pocket knives, retractable-blade utility knives, razor blade knives and serrated knives



48036

WARNING: Improper use of knife and scissors sharpener and/or failure to follow instructions can result in injuries. Keep your fingers behind the curved guard and your thumb securely on the multi-grooved thumb-rest indentation, never in front of it.

Cat. No.	Overall Length	Overall Width	Weight
48036	4" (101.6 mm)	2.25" (57.2 mm)	0.10 lb (0.05 kg)

Electrician's Scissors

Electrician's Scissors

- Nickel plated to resist corrosion (Cat. Nos. 2100-5 and 2100-7)
- Notches for stripping 19 AWG and 23 AWG wire on the upper blade (Cat. Nos. 2100-7, 2100-8 and 2100-9)
- Extended handle to provide comfort and cutting leverage (Cat. No. 2100-8)



2100-8



2100-7



2100-5



2100-9

Cat. No.	Special Features	Application	Material	Cutting Length	Overall Length	Weight
2100-5	Scraper, File	Telecom, Electrical, Heavy-Duty Cutting	Steel	1.875" (47.6 mm)	5.25" (133.4 mm)	0.20 lb (0.09 kg)
2100-7	Scraper, File, Stripping Notches, Serrated Blades	Telecom, Electrical, Heavy-Duty Cutting	Steel	1.875" (47.6 mm)	5.25" (133.4 mm)	0.20 lb (0.09 kg)
2100-8	Free-Fall Snip, Extended Handle, Serrated Blades	Wire Cutting; Stripping	Stainless Steel	1.875" (47.6 mm)	6.313" (160.4 mm)	0.21 lb (0.10 kg)
2100-9	Free-Fall Snip, Serrated Blades	Wire Cutting; Stripping	Stainless Steel	1.875" (47.6 mm)	5.25" (133.4 mm)	0.21 lb (0.10 kg)

WARNING: Blades are intended for cutting only, and should be handled and disposed of with care. Bending the blade can cause it to break, possibly resulting in bodily injury. Check local laws on legality of selling or possessing these knives.



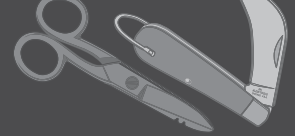

Electrician's Scissors

All-Purpose Electrician's Scissors

- Cable cutting notch in blade provides increased leverage and stability on tough cuts of up to 14 AWG wire
- Strips 19 and 23 AWG wire
- Durable, forged high carbon steel blades maintain sharpness and outlast stamped designs
- Ergonomic handle fits a variety of hold preferences
- Notch in tip for deburring electrical boxes
- Serrated teeth allow for non-slip cutting action
- Scraper on both blades for cleaning wire



2600-1

Cat. No.	Special Features	Application	Material	Cutting Length	Overall Length	Weight
26001	Serrated Blades, Notches	Cable Cutting, Stripping, Deburring	Carbon Steel	1.875" (47.6 mm)	6.75" (171.5 mm)	4.6 oz (132 g)

Industrial High-Leverage Shears

High-Leverage Snip

- Nickel-chrome plating resists corrosion and rusting
- Cat. Nos. 22001 and 22002 have broad, short jaws



22000



22001



22002



22003

Cat. No.	Description	Special Features	Application	Material	Cutting Length	Overall Length	Weight
22000	High-Leverage Snip	—	Cuts Light Metals, Rubber, Heavy Fabrics	Forged Steel	1.75" (44.5 mm)	6.5" (165.1 mm)	0.34 lb (0.15 kg)
22001	Broad Blade Utility Shear	Serrated Blade, Broad Short Jaws	Cuts Light Wire, Fabric, Cable, Cordage	Forged Steel	2" (50.8 mm)	8" (203.2 mm)	0.55 lb (0.25 kg)
22002	Large Broad Blade Utility Shear	Extended Handles, Serrated Blade, Broad Short Jaws	Cuts Light Metal, Rubber, Cable, Wire Metal Screens, Cordage, Plastic, Ropes	Forged Steel	2" (50.8 mm)	8.5" (215.9 mm)	0.55 lb (0.25 kg)
22003	High Leverage Utility Shear, 8"	Extended Handles	Cuts Light Metals, Rubber, Heavy Fabrics	Forged Steel	3" (76.2 mm)	9" (228.6 mm)	0.49 lb (0.22 kg)

See page 297 for additional information on warnings.



⚠ WARNING: Blades are intended for cutting only, and should be handled and disposed of with care. Bending the blade can cause it to break, possibly resulting in bodily injury. **Check local laws on legality of selling or possessing these knives.**

Industrial Utility Snips

High-Leverage Kevlar® Snip

- Nickel-chrome plating resists corrosion and rusting
- Compatible for right- and left-handed users



Cat. No.	Description	Special Features	Application	Material	Cutting Length	Overall Length	Weight
24000	High Leverage Kevlar® Snip	Closure Lock, Serrated Blade, Spring-Loaded	Fiberoptic (Cutting Kevlar® Insulation)	Steel	0.625" (15.9 mm)	6.5" (165.1 mm)	0.28 lb (0.13 kg)
24001	Rapid Cutting Snip	Closure Lock, Serrated Blade, Spring-Loaded	Fiberoptic (Cutting Kevlar® Insulation); Cuts Stranded Wire, Light Metal, Cordage	Steel	1" (25.4 mm)	5" (127.0 mm)	0.28 lb (0.13 kg)

Kevlar® is a registered trademark of E.I. du Pont de Nemours and Company.

Bent Trimmers

Bent Trimmers

- Nickel-chrome plating resists corrosion and rusting

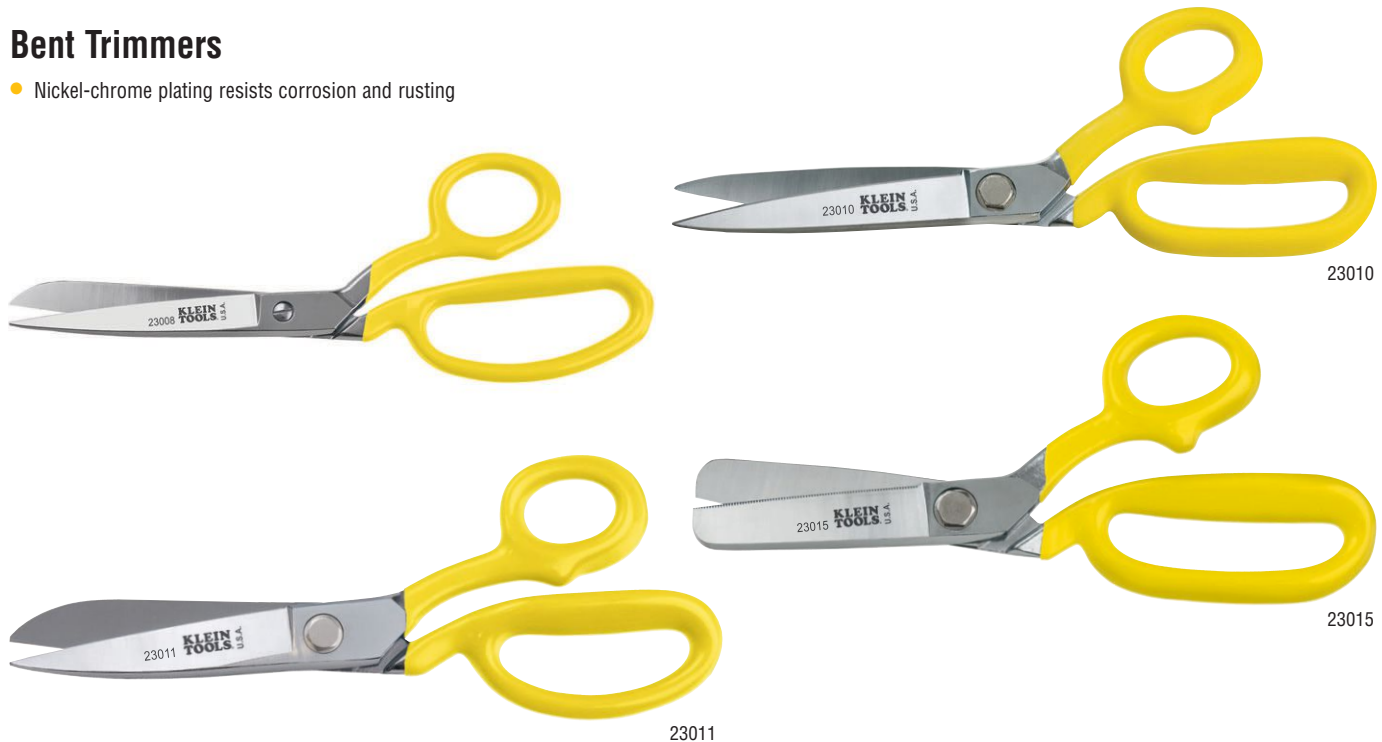

Cat. No.	Description	Special Features	Application	Material	Cutting Length	Overall Length	Weight
23008	Bent Trimmer, 8"	Extended Handle	Cuts Plastic, Rubber, Tar Paper, Cording, Vinyl, Fiberglass Insulation and Cloth Materials	Metal	3.5" (88.9 mm)	9" (228.6 mm)	0.41 lb (0.19 kg)
23010	Bent Trimmer, 10"	Extended Handle	Cuts Plastic, Rubber, Tar Paper, Cording, Vinyl, Fiberglass Insulation and Cloth Materials	Metal	4.5" (114.3 mm)	10.5" (266.7 mm)	0.99 lb (0.45 kg)
23011	Bent Trimmer, 11-1/4"	Extended Handle	Cuts Felt Lining, Muslin, Cord, Rubber, Abrasive Materials and Multiple Layers of Fabric	Metal	4.75" (120.7 mm)	11.25" (285.8 mm)	1.2 lb (0.6 kg)
23015	Single Serrated Blunt Blade Shear	Extended Handle, Serrated Blade	Cuts Belting, Heavy Fabric or Carpet, Leather, Upholstery	Metal	3.188" (81 mm)	9.75" (247.7 mm)	0.94 lb (0.43 kg)

⚠WARNING: Blades are intended for cutting only, and should be handled and disposed of with care. Bending the blade can cause it to break, possibly resulting in bodily injury. **Check local laws on legality of selling or possessing these knives.**





Lineman Buckets & Accessories

Klein canvas buckets and accessories have been recognized for decades for their durability and dependability. They are built for strength to handle professional wear and tear.

For Professionals...
Since 1857™

Load Rated Buckets

Flame-Resistant Canvas Buckets



- ⚠️ WARNINGS:**
- Inspect for damage before each use.
 - Remove from service if bucket shows signs of wear.
 - Never exceed the working load limit.

FR

NFPA-701

Meets the performance requirement of NFPA -701

Load Rated Buckets

- Durable straight wall buckets made of heavy-duty materials to withstand the harshest job site conditions
- Reinforced bottoms extend up the sides for added durability
- Web straps extend down the sides for additional strength
- Hold a 5 gallon bucket (not included) (Cat. Nos. 5104CLR17 and 5104CLR22)
- Interior D-ring for tether connection (Cat. No. 5104OCTO)
- Bright orange water-resistant vinyl for easy visibility and keeps tools dry (Cat. Nos. 5109CSV and 5109SV)



Cat. No.	Load Rating	Diameter	Material	Special Features	Overall Height	Weight
Leather Reinforced Bottom						
5104	100 lb (45 kg)	12" (304.8 mm)	No. 4 Canvas	Interior Pocket	17" (431.8 mm)	2.7 lb (1.2 kg)
5104S	100 lb (45 kg)	12" (304.8 mm)	No. 4 Canvas	Interior Pocket, Swivel Snap (Cat. No. 2012)	17" (431.8 mm)	2.9 lb (1.3 kg)
5104OCTO	100 lb (45 kg)	12" (304.8 mm)	No. 1 Canvas	Interior Pocket, Oversized Hook, D-Ring Connection Points, Work-At-Height Approved	15" (381.0 mm)	6.0 lb (2.7 kg)
5104FR	100 lb (45 kg)	12" (304.8 mm)	No. 4 Flame-Resistant Canvas	Interior Pocket	17" (431.8 mm)	3.1 lb (1.4 kg)
5104CLRFR	100 lb (45 kg)	12" (304.8 mm)	No. 4 Flame-Resistant Canvas	Interior Pocket, Double Action Carabiner, Zipper Closed Top, Leather Covered Strap, Work-At-Height Approved	17" (431.8 mm)	4.25 lb (1.93 kg)
5104CLR17	150 lb (68 kg)	14" (355.6 mm)	No. 1 Canvas	Swivel Snap (Cat. No. 2012), Zipper Closed Top, Work-At-Height Approved	17" (431.8 mm)	6.7 lb (3.0 kg)
5104CLR22	150 lb (68 kg)	14" (355.6 mm)	No. 1 Canvas	Heavy Duty D Ring, Zipper Closed Top, Work-At-Height Approved	22" (558.8 mm)	7.0 lb (3.2 kg)
Black Molded Polypropylene Bottom						
5109	75 lb (34 kg)	12" (304.8 mm)	No. 6 Canvas	—	15" (381.0 mm)	2.1 lb (0.9 kg)
5109S	75 lb (34 kg)	12" (304.8 mm)	No. 6 Canvas	Swivel Snap (Cat. No. 2012)	15" (381.0 mm)	2.0 lb (0.9 kg)
5109P	75 lb (34 kg)	12" (304.8 mm)	No. 6 Canvas	Interior Pocket	15" (381.0 mm)	2.1 lb (1.0 kg)
5109PS	75 lb (34 kg)	12" (304.8 mm)	No. 6 Canvas	Interior Pocket, Swivel Snap (Cat. No. 2012)	15" (381.0 mm)	2.4 lb (1.1 kg)
NEW 5109SV	100 lb (45 kg)	12" (304.8 mm)	Vinyl	Swivel Snap (Cat. No. 2012)	15" (381.0 mm)	2.37 lb (1 kg)
NEW 5109CSV	100 lb (45 kg)	12" (304.8 mm)	Vinyl	Swivel Snap (Cat. No. 2012), Zipper Closed Top, Work-At-Height Approved	17" (431.8 mm)	1.75 lb (0.8 kg)
5109SLR	150 lb (68 kg)	12" (304.8 mm)	No. 4 Canvas	Swivel Snap (Cat. No. 2012), Drain Holes	15" (381.0 mm)	6.0 lb (2.7 kg)

VELCRO® is a registered trademark of Velcro Industries B.V.



Canvas Buckets

Canvas Buckets

- Durable canvas construction

Cat. No.	Diameter	Material	Special Features	Overall Height	Weight
Black Molded Polypropylene Bottom					
5106	9" (228.6 mm)	No. 6 Canvas	—	14" (355.6 mm)	1.5 lb (0.7 kg)
5106P	9" (228.6 mm)	No. 6 Canvas	Two 7" (177.8) Square Inside Pockets	14" (355.6 mm)	1.6 lb (0.7 kg)
5106S	9" (228.6 mm)	No. 6 Canvas	Swivel Snap (Cat. No. 2012)	14" (355.6 mm)	1.8 lb (0.8 kg)
Leather Reinforced Bottom					
5104VT	12" (304.8 mm)	No. 1 Canvas	VELCRO® Closure, Rope Handle, Work-At-Height Approved	17" (431.8 mm)	3.0 lb (1.4 kg)



Tapered-Wall Buckets

- Black molded polypropylene bottom
- Top diameter is 12" (305 mm) and tapers to 9" (229 mm) at the bottom
- Riveted leather glove strap (Cat. Nos. 5103S, 5171PS and 5172PS)



Cat. No.	Material	Special Features	Overall Height	Weight
5113	No. 6 Canvas	—	13" (330.2 mm)	1.6 lb (0.7 kg)
5113S	No. 6 Canvas	Swivel Snap (Cat. No. 2012)	13" (330.2 mm)	1.8 lb (0.8 kg)
5103S	No. 4 Canvas	Swivel Snap (Cat. No. 2012)	12" (304.8 mm)	2.0 lb (0.9 kg)
5171PS	No. 4 Canvas	Swivel Snap (Cat. No. 2012); 4 Exterior Pockets	12" (304.8 mm)	2.2 lb (1.0 kg)
5172PS	No. 4 Canvas	Swivel Snap (Cat. No. 2012); 15 Interior Pockets	12" (304.8 mm)	2.4 lb (1.1 kg)

Vinyl Bucket Top

- Top cover for canvas bucket designed to keep the elements out and tools securely inside
- Compatible with Klein Tools 5104 and 5109 series buckets
- Attaches with Velcro®
- Includes safety strap loop to ensure connection to bucket
- Bucket not included

Cat. No.	Overall Height	Diameter	Weight
51TOP	3.5" (88.9 mm)	12-1/2" (317.5 mm)	0.40 lb (0.18 kg)



51TOP

VELCRO® is a registered trademark of Velcro Industries B.V.

Oval Buckets

Oval Bucket with Pockets

- Black molded polypropylene bottom
- Cat. Nos. 5144S and 5152S have sisal-rope handles equipped with Cat. No. 2012 swivel snap hook
- Cat. No. 5144 includes two nylon 66 polymer hooks (Cat. No. 5144H)



Cat. No.	Overall Height	Material	Color	Number of Pockets	Weight
5144S	10" (254.0 mm)	No. 6 Canvas	Natural	15	2.2 lb (1.0 kg)
5152S	10" (254.0 mm)	No. 6 Canvas	Natural	41	2.5 lb (1.1 kg)
5144	10" (254.0 mm)	No. 6 Canvas	Natural	15	2.0 lb (0.91 kg)
5144B	10" (254.0 mm)	No. 6 Canvas	Natural	15	1.5 lb (0.68 kg)

Hard Body Oval Buckets

- Black molded polypropylene bottom with drain holes
- Cat. No. 5144HBS includes leather skinning knife sheath and 14 other interior pockets
- Cat. No. 5144H hooks sold separately



Cat. No.	Overall Height	Material	Color	Number of Pockets	Weight
5144BHB	10" (254.0 mm)	Non-conductive High Density Polyethylene	Orange	14	2.0 lb (0.91 kg)
5144BHHB	10" (254.0 mm)	Non-conductive High Density Polyethylene	Orange	14	2.0 lb (0.91 kg)
5144BHB140S	10" (254.0 mm)	Denier Polyester	Black	29	3.0 lb (1.36 kg)
5144HBS	10" (254.0 mm)	Plastic; Denier Polyester; Polypropylene	Orange	15	2.0 lb (0.91 kg)



Canvas Bags

Canvas Tapered-Bottom Bag

- Two pockets are provided for small parts
- Bottom is tapered so parts will stay in center
- Equipped with a snap for hanging

Cat. No.	Diameter	Material	Special Features	Overall Height	Weight
5143	6-1/2" (165.1 mm)	No. 10 Canvas	Two Internal Pockets; Snap Hook	8" (203.2 mm)	0.30 lb (0.14 kg)



5143

Line-Hose Bag

- No. 6 canvas with top ring and molded bottom
- Large enough to accommodate several pieces of hose
- Can also be used to raise protective rubber blankets that are rolled
- Leather cuff extends 3" (76.2 mm) up the side
- Polypropylene rope handle is reinforced with leather

Cat. No.	Overall Height	Diameter	Weight
5110-48	48" (121.9 cm)	7" (177.8 mm)	1.9 lb (0.9 kg)



5110-48

Canvas Electrode Bags

- Made of tough No. 4 canvas
- Heat-resistant, hard leather bottom
- Cat. No. 5471FR is made of flame-retardant No. 4 canvas which meets the performance requirement of NFPA -701
- Web loop for sliding over belt



5471FR

5471

Cat. No.	Diameter	Front Depth	Back Depth	Weight
5471	2-1/2" (63.5 mm)	12" (304.8 mm)	15.5" (393.7 mm)	0.25 lb (0.11 kg)
5471FR	2-1/2" (63.5 mm)	12" (304.8 mm)	15.5" (393.7 mm)	0.25 lb (0.11 kg)

Lineman Accessories

Aerial Aprons

- Includes: ten hand tool pockets, two pouches, hammer loop and two drill bit holders (Cat. Nos. 51829 and 51829M)
- Two pouches reinforced with heavy duty rivets
- Cat. No. 5144H hooks sold separately
- Hot stick pocket (Cat. No. 51829MHS)
- Sewn-in magnet conveniently holds nuts, bolts and other small metal objects (Cat. No.s 51829M and 51829MHS)



51828



51829M

	Cat. No.	Overall Height	Overall Width	Color	Number of Pockets	Magnetic	Weight
NEW	51828	19.5" (495.3 mm)	4" (101.6 mm)	Orange	8	No	2.2 lb (1 kg)
	51829	23" (584.2 mm)	24" (609.6 mm)	Orange	18	No	4.0 lb (1.8 kg)
	51829M	23" (584.2 mm)	24" (609.6 mm)	Orange	18	Yes	4.0 lb (1.8 kg)
	51829MHS	27.5" (698.5 mm)	32" (812.8 mm)	Orange	16	Yes	4.0 lb (1.8 kg)

Swivel Snap Hook

- This is NOT an occupational protective hook. NOT for human support
- Bronze swivel snap hook made for use on canvas buckets
- Maximum safe load 150 lbs. (68 kg)



2012

Cat. No.	Throat Opening	Overall Length	Overall Width	Weight
2012	2 1/32" (16.7 mm)	4.375" (111.1 mm)	1.625" (41.3 mm)	0.28 lb (0.13 kg)

Hook for Aerial-Baskets and Buckets

- All weather, durable, nylon 66 polymer
- Most manufacturers' aerial basket trucks accommodate bucket hook
- Replacement hook for 5144 Series Baskets and Buckets except 5144S



5144H

Cat. No.	Overall Length	Overall Width	Weight
5144H	5.5" (139.7 mm)	5.5" (139.7 mm)	0.30 lb (0.14 kg)

Pole Pick and Pouch

- Helps determine the condition of a utility pole before climbing
- Extra sharp point for piercing many types of wood poles
- Smooth Comfordome handle fits the palm of the hand comfortably



66141KIT

Cat. No.	Includes	Weight
66141KIT	Pole Pick and Pole Pick Pouch	0.40 lb (0.18 kg)

Pole Sling

- For use where a running loop wrap around pole is desired
- Nylon web stitched with nylon thread



5606

Cat. No.	Overall Length	Overall Width	Rated Capacity	Weight
5606	39" (990.6 mm)	2" (50.8 mm)	Choke Hitch: 3000 lb (1361 kg), Basket Hitch: 4700 lb (2132 kg)	1.3 lb (0.6 kg)

⚠WARNING: This is NOT an occupational protective device. NOT for human support.



Block & Tackle

Klein's line of block and tackle is engineered for high-strength requirements.

For Professionals...
Since 1857™

Hooks and Rope

Anchor Hook

- Forged hook is designed to fit under insulator and engage pin of cross arm
- Maximum safe load 750 lbs. (340 kg)



258

Cat. No.	Eye I.D.	Throat Opening	Overall Length	Weight
258	5/8" (15.9 mm)	1-7/8" (47.6 mm)	5.5" (139.7 mm)	0.42 lb (0.19 kg)

Swivel Anchor Hook

- Swivel clevis on this forged hook will engage with snap on Klein block & tackle Cat. Nos. 1802-30 and H1802-30
- Swivel prevents twisting and kinking of rope
- Cat. No. 470 has plunger latch
- Maximum safe load 750 lbs. (340 kg)



259



470

Cat. No.	Swivel Opening	Throat Opening	Overall Length	Weight
259	1-3/16" x 1" (30.2 x 25.4 mm)	1-7/8" (47.6 mm)	6.5" (165.1 mm)	0.40 lb (0.18 kg)
470	1-3/16" x 1" (30.2 x 25.4 mm)	5/8" (15.9 mm)	5" (127.0 mm)	0.30 lb (0.14 kg)

Polypropylene Hand-Lines with Snap Hook



1804-60

- Made of 5/16" (7.9 mm) three-strand polypropylene rope spliced to eye of snap hook
- Both lines 75' (23 m) long
- Forged steel with swivel clevis and quick-acting plunger-style latch
- Maximum safe load 250 lbs. (113 kg)

Cat. No.	Description	Included	Weight
1803-60	Polypropylene Hand-Line with Snap Hook	75' (22.86 m) of 5/16" (7.93 mm) Rope with Cat. No. 443A Snap	2.5 lb (1.1 kg)
1804-60	Polypropylene Hand-Line with Swivel Hook	75' (22.86 m) of 5/16" (7.93 mm) Rope with Cat. No. 470 Swivel Snap	2.2 lb (1.0 kg)

Heavy-Duty Snap Hook

- Snaps on with one hand
- Forged hook may be used on many conventional steel blocks, 4" (102 mm) or smaller
- Maximum safe load 8000 lbs. (3629 kg)



455

Cat. No.	Eye I.D.	Throat Opening	Overall Length	Weight
455	15/16" (23.8 mm)	1" (25.4 mm)	5" (127.0 mm)	0.84 lb (0.38 kg)

Snap Hook

- General-purpose forged snap hook with eye at 90° to opening
- Maximum safe load 1500 lbs. (675 kg)



443A

Cat. No.	Eye I.D.	Throat Opening	Overall Length	Weight
443A	1" (25.4 mm)	1/2" (12.7 mm)	5.5" (139.7 mm)	0.52 lb (0.24 kg)

Swivel Snap Hook

- Bronze swivel snap hook made for use on canvas buckets
- Maximum safe load 150 lbs. (68 kg)



2012

Cat. No.	Throat Opening	Overall Length	Overall Width	Weight
2012	21/32" (16.7 mm)	4.375" (111.1 mm)	1.625" (41.3 mm)	0.28 lb (0.13 kg)

Rope

- Works with all block and tackle products
- High-quality, 3/8" diameter rope
- Maximum safe load 750 lbs. (340 kg)



48502

Cat. No.	Diameter	Tensile Strength	Overall Length	Weight
48502	3/8" (9.5 mm)	3600 lb (1632 kg)	25' (7.6 m)	0.78 lb (0.35 kg)

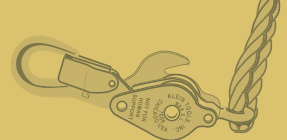

Block & Tackle

Blocks

- Blocks without ropes and hooks
- Made of light galvanized steel and aluminum alloy
- Sheaves have bronze bushings
- Maximum safe load 750 lbs. (340 kg)

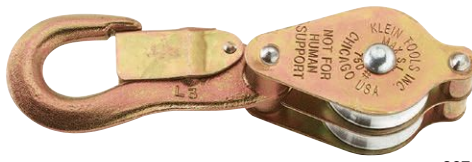

267



268



H267



H268

Cat. No.	Description	Weight
267	Self-locking Block Without Rope and Hook	0.76 lb (0.34 kg)
H267	Block with Nose Extended Over Keeper	0.80 lb (0.36 kg)
268	Block with Eye to Splice Line to Block	0.90 lb (0.41 kg)
H268	Block with Eye and Nose Extended Over Keeper	1.0 lb (0.5 kg)

Howe Wire Tool

- Strap is made of tough Klein-Kord™
- Swivel hook is forged steel with large opening
- Shank of hook is lengthened to reach under insulator
- Other end has device to hold the load at any distance
- All metal parts are galvanized
- Max. safe load 500 lbs. (225 kg)



1720-20N



170220HH

Cat. No.	Overall Width	Weight
1720-20N	1" (25.4 mm)	2.0 lb (0.9 kg)
1702-20HH	1.5" (38.1 mm)	2.75 lb (1.25 kg)

Web Strap Ratchet Hoist

- Large, non-conductive drum knob allows web slack to be adjusted with ease
- 360° handle rotation
- 3/4 ton single line and 1-1/2 ton double line load rating
- Tight ratcheting mechanism allows precise tensioning
- Meets ANSI/ASME B30.21-2005 & B30.10-2009 standards
- Cat. No. KN1500PEXH includes hot rings
- Cat. No. KN1600PEX includes a removable handle



- **Single Line Load Rating:** 1500 lbs. (675 kg)
Min. to Max. Pulling Distance inches (mm):
20" (500 mm) - 138" (3500 mm)



- **Double Line Load Rating:** 3000 lbs. (1350 kg)
Min. to Max. Pulling Distance inches (mm):
26" (700 mm) - 79" (2000 mm)



KN1600P-EX

Cat. No.	Weight
KN1500PEX	12.5 lb (5.7 kg)
KN1500PEXH	13.6 lb (6.2 kg)
KN1600PEX	13 lb (5.9 kg)

See page 297 for additional information on warnings.

WARNING: This is NOT an occupational protective device. NOT for human support.

Block & Tackle Packages

Block and Tackle with Standard Hooks

- Sheaves are strong, yet lightweight aluminum alloy with all-bronze bushings.
- Light, galvanized-steel shell blocks are fitted with snubbing hooks to hold the load.
- All Klein block and tackle use high-quality, 3/8" diameter rope.
- Available with standard snap hooks or guarded snap hooks (with snap hook nose lengthened to extend over the latch or keeper).
- Choice of forged hook Cat. No. 258 or swivel hook Cat. No. 259.
- Catalog numbers followed by S/R have rope spliced to block.
- Maximum safe load is 750 lbs. (338 kg).



Cat. No.	267 Block	268 Block	258 Anchor Hook	259 Swivel Anchor Hook	Rope Spliced to Component Number	Weight
1802-30	•	•	•			2.8 lb (1.3 kg)
1802-30SR	•	•	•		268 Block	2.8 lb (1.3 kg)
1802-30S	•	•		•		2.9 lb (1.3 kg)
1802-30SSR	•	•		•	268 Block	2.8 lb (1.3 kg)



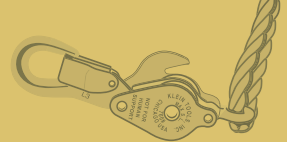

Block & Tackle Packages

Block and Tackle with Guarded Hooks

- Sheaves are strong, yet lightweight aluminum alloy with all-bronze bushings.
- Light, galvanized-steel shell blocks are fitted with snubbing hooks to hold the load.
- All Klein block and tackle use high-quality, 3/8" diameter rope.
- Available with standard snap hooks or guarded snap hooks (with snap hook nose lengthened to extend over the latch or keeper).
- Choice of forged hook Cat. No. 258 or swivel hook Cat. No. 259.
- Catalog numbers followed by S/R have rope spliced to block.
- Maximum safe load is 750 lbs. (338 kg).



Cat. No.	H267 Block	H268 Block	258 Anchor Hook	259 Swivel Anchor Hook	Rope Spliced to Component Number	Weight
H1802-30	•	•	•			2.9 lb (1.3 kg)
H1802-30SR	•	•	•		H268 Block	2.8 lb (1.3 kg)
H1802-30S	•	•		•		3.0 lb (1.4 kg)
H1802-30SSR	•	•		•	H268 Block	3.0 lb (1.4 kg)



H1802-30



H1802-30 S/R



H1802-30S



H1802-30S S/R

See page 297 for additional information on warnings.

WARNING: This is NOT an occupational protective device. NOT for human support.

Wire Pulling Grips

Klein Tools has been manufacturing grips for over 135 years. Klein combines strength and durability to create an extremely high-quality line of grips. With ease-of-use and reliability, Klein wire-pulling grips set the mark.



For Professionals...
Since 1857™

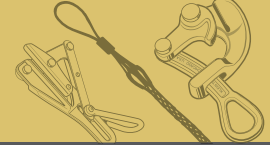

Recommended Care and Maintenance

Grip Cleaning, Lubricating and Inspecting

The following guidelines have been established to keep all grips in good working condition.

Inspection

Step 1. Carefully inspect jaw condition, proper alignment of jaws and all parts, and possible distortion caused by exceeding safe-load specifications. Grips should operate smoothly. Spring-loaded grips should lock open with loop handle in "Down" position and should close automatically with loop handle "Up." The Klein Parallel Jaw Grip may be tested by opening and closing the jaws by hand, exercising proper caution. All parts and rivets should be checked for distortion

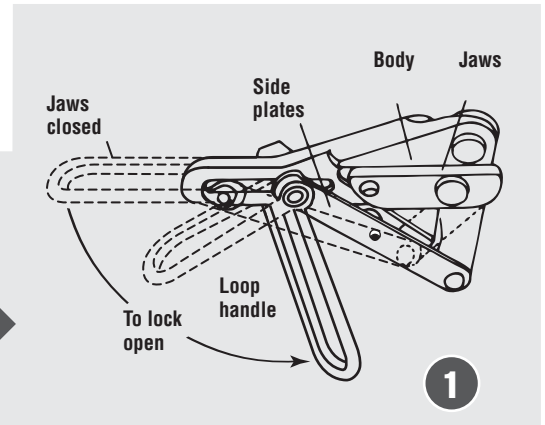

Cleaning



Step 2. Use the Klein Grip Cleaning Wire Brush Set (Cat. No. 25450) to clean the surfaces of grip jaws



Step 3. Spray degreaser on the grip jaws, all joints and moving parts



Step 4. Use the Klein Grip Cleaning Wire Brush to remove dirt and debris from the grip jaws

Step 5. Wipe grips dry with a cloth. Repeat necessary cleaning steps until grip is completely clean



Lubricating

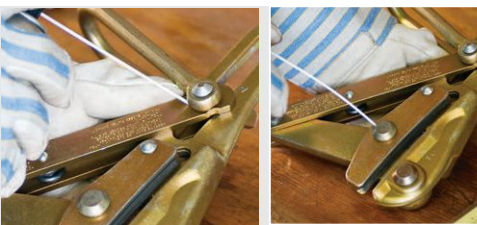

Step 6. Apply lubricant to all joints and moving parts. Do NOT lubricate gripping surfaces of jaws.

Note: Conductors may have a die-grease coating which can deposit on grip jaws. New conductors should be wiped clean before grip application. Grip jaws should be wiped clean of all grease before use.

Never repair any grip. Grips that are bent, misaligned, or otherwise distorted should be discarded and replaced.

If there is ever a question about the safe condition of any grip, please contact Klein Tools Customer Service directly at **844-395-3235** or email **Hisupport@kleintools.com**.

Types of Wire Pulling Grips

Klein Chicago™, Parallel Jaw and Haven's™ Grips are widely used in the power, communications, and general construction fields to pull wire and cable. The grips maintain temporary tension until the wire or cable can be permanently terminated.

Chicago™ Grips

Designed for use on aluminum, copper, weatherproof coated wire, PVC covered conductors and messenger and guy strand

- Locking loop handles allow the jaws to be held in an open position for easy placement on wire or cable
- Available in Round, Double V, Single V and Aggressive jaw contours



Single V Jaw Contour



Double V Jaw Contour



Round Jaw Contour



Aggressive Jaw Contour



1656-30

Parallel Jaw Grips

Lightweight compact grips pull an exceptionally wide range of cable types and sizes

- Latch helps maintain cable position
- Large-diameter eye accommodates large hooks on hoists, winches and tackle blocks
- Available in Round and Double V jaw contours



Double V Jaw Contour



Round Jaw Contour



KT4500

Haven's™ Grips

Designed for use when a light, compact grip is desired where conductor deformation is not a factor

- Knurled eccentric jaw applies gripping pressure to 1/4" of cable area
- Some models include a swing latch that holds cable securely in jaw
- Recommended for messenger and guy strand and wire rope
- 1625 Series can be used for wire rope



1625-20

Hot-line Latch

Designed for placing a grip on cable with a hot-line stick

- The three notches in the hot-line latch adjust the balance of the grip to better match the direction of the cable sag
- When stick is removed, latch closes automatically to guard against grip accidentally disengaging from wire
- Standard hot-line grips are not supplied with springs or lock-open features
- Some grips are available with a positionable latch

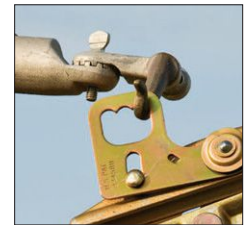

Wire Pulling Grips Warnings

⚠WARNING: Do not exceed rated capacity.

⚠WARNING: Always match proper size and type of grip to application.







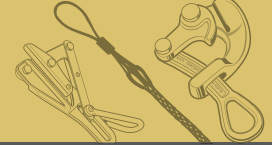

⚠WARNING: Before each use, clean jaw area and inspect grip for proper operation to avoid slippage.

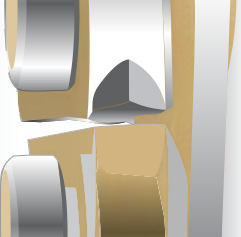
⚠WARNING: Grips are to be used for temporary installation, not for permanent anchorage.

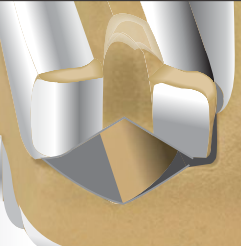
⚠WARNING: When used on/or near energized lines, ground, insulate, or isolate grip before pulling.

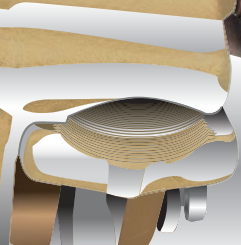

Types of Jaw Contours

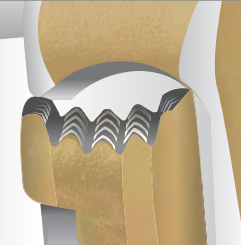
 Single V	Steel Strand Cat. No.				
	<ul style="list-style-type: none"> Simple three-point contact jaws. Designed for use on small diameter bare wire and cable (solid and stranded). 	1613-30	-		
 Double V	Steel Strand Cat. No.		Wide Range of Cables Cat. No.		
	<ul style="list-style-type: none"> Four-point contact provides greater gripping pressure and assures proper alignment of wire and cable within the jaws. Designed for high strength messenger and guy strand and extra high-strength cables and conductors. 	1613-40 and 1613-40H, 1628-16 1628-16AT (Bell System) 1628-17, 1628-18, 1684-5 1684-5AT (Bell System) 1684-5H, 1692-5 1692-5AT (Bell System) 1684-74 and S1684-74H (EHS Cable) 1684-5F	1671-10 1672-10 1686-10 1686-20	-	
 Round	ACSR and AAC Cat. No.		Weatherproof and PVC Covered Copper Cat. No.	Steel Strand Cat. No.	Wide Range of Cables Cat. No.
	<ul style="list-style-type: none"> Round jaws provide maximum contact and gripping power to minimize conductor deformation. (Smooth and knurled styles). Recommended for use on bare aluminum, and copper conductors. 	1628-16P SERIES 1628-30 SERIES 1628-40 SERIES 1628-50 SERIES 1656-20 and 1656-20H 1656-30 and 1656-30H 1656-40 and 1656-40H 1656-50 and 1656-50H 1656-60 and 1656-60H	 Notched Jaw 1611-20 1611-30 1611-40 1611-50	 Serpentine Jaw 1659-20 1659-30 1659-40 1659-50	 Serpentine Jaw 1659-5AT 1685-20 1685-31
 Aggressive	Steel Strand Cat. No.				
	<ul style="list-style-type: none"> Recommended for use when conductor deformation is not an issue or when a more aggressive bite is needed. 	1604-10 1604-20 1604-20L 1625-20 (For Wire Rope) 1625-20 1 (For Wire Rope) 1625-20 7/8 (For Wire Rope) 1684-5C (EHS)			

Selecting the Proper Grip

Grip Recommendation

Klein Tools offers a service of recommending the proper grip for a particular application based on a sample of cable. This service is free of charge. All that we require is a minimum 6-9 foot (2-3 m) length of cable.

If there is ever a question about the safe condition of any grip, please contact Klein Tools at **844.395.3235** or email: Hlsupport@kleintools.com

Three basic factors are needed in order to determine the proper grip for each specific application:

- 1. Type of wire or cable (ACSR, ACSS, AAC, Copper, Steel Strand).**
- 2. AWG or MCM (diameter) of wire or cable.**
- 3. Maximum safe load required.**

ACSR (Aluminum Conductor Steel Reinforced)



**For Cable Diameter
4 AWG - 636 MCM
.250" - .953" (6.35 mm - 24.21 mm)**

MAXIMUM SAFE LOAD

AWG or MCM Cable Size	Diameter inches (mm)	No. of Alum. & Steel Strands	Code Word	MAXIMUM SAFE LOAD			
				A 4,500 lbs (2041 kg)	B 8,000 lbs (3629 kg)	C 15,000 lbs (6803 kg)	D 20,000 lbs (9072 kg)
				Cat. No.	Cat. No.	Cat. No.	Cat. No.
4	.250" (6.35 mm)	6 x 1	Swan	1656-20, 1656-20H & S1656-20H			
4	.257" (6.53 mm)	7 x 1	Swanate	1656-20, 1656-20H & S1656-20H			
2	.316" (8.03 mm)	6 x 1	Sparrow	1656-20, 1656-20H, S1656-20H, 1656-30, 1656-30H & S1656-30H			
2	.325" (8.26 mm)	7 x 1	Sparate	1656-20, 1656-20H, S1656-20H, 1656-30, 1656-30H & S1656-30H			
1	.354" (9.02 mm)	6 x 1	Robin	1656-20, 1656-20H, S1656-20H, 1656-30, 1656-30H & S1656-30H			
1/0	.398" (10.11 mm)	6 x 1	Raven	1656-20, 1656-20H, S1656-20H, 1656-30, 1656-30H & S1656-30H			
2/0	.447" (11.35 mm)	6 x 1	Quail	1656-30, 1656-30H & S1656-30H		1628-16PG*	
3/0	.502" (12.75 mm)	6 x 1	Pigeon	1656-30, 1656-30H & S1656-30H		1628-16PH*	
4/0	.563" (14.30 mm)	6 x 1	Penguin	1656-30, 1656-30H & S1656-30H		1628-16PI*	
266.8 MCM	.609" (15.47 mm)	18 x 1	Waxwing		1656-40, 1656-40H & S1656-40H	1628-16PJ*	
266.8 MCM	.642" (16.31 mm)	26 x 7	Partridge		1656-40, 1656-40H & S1656-40H	1628-16PK*	
300 MCM	.680" (17.27 mm)	26 x 7	Ostrich		1656-40, 1656-40H & S1656-40H	1628-16PK*	
336.4 MCM	.684" (17.37 mm)	18 x 1	Merlin		1656-40, 1656-40H & S1656-40H	1628-16PK*	
336.4 MCM	.720" (18.31 mm)	26 x 7	Linnet		1656-40, 1656-40H & S1656-40H	1628-16PL*	
336.4 MCM	.741" (18.82 mm)	30 x 7	Oriole		1656-50, 1656-50H & S1656-50H	1628-16PL*	
397.5 MCM	.743" (18.87 mm)	18 x 1	Chickadee		1656-50, 1656-50H & S1656-50H	1628-16PL*	
397.5 MCM	.772" (19.61 mm)	24 x 7	Brant		1656-50, 1656-50H & S1656-50H	1628-16PM*	
397.5 MCM	.783" (19.89 mm)	26 x 7	Ibis		1656-50, 1656-50H & S1656-50H	1628-16PM*	
397.5 MCM	.806" (20.47 mm)	30 x 7	Lark		1656-50, 1656-50H & S1656-50H	1628-16PM*	
477 MCM	.814" (20.68 mm)	18 x 1	Pelican		1656-50, 1656-50H & S1656-50H	1628-16PM*	
477 MCM	.846" (21.49 mm)	24 x 7	Flicker		1656-50, 1656-50H & S1656-50H	1628-16PN*	1628-30N*
477 MCM	.858" (21.79 mm)	26 x 7	Hawk		1656-50, 1656-50H & S1656-50H	1628-16PN*	1628-30N*
477 MCM	.883" (22.43 mm)	30 x 7	Hen		1656-60, 1656-60H & S1656-60H	1628-16PN*	1628-30N*
556.5 MCM	.879" (22.33 mm)	18 x 1	Osprey		1656-60, 1656-60H & S1656-60H	1628-16PN*	1628-30N*
556.5 MCM	.914" (23.22 mm)	24 x 7	Parakeet		1656-60, 1656-60H and S1656-60H		1628-300*
556.5 MCM	.927" (23.55 mm)	26 x 7	Dove		1656-60, 1656-60H & S1656-60H		1628-300*
556.5 MCM	.953" (24.21 mm)	30 x 7	Eagle		1656-60, 1656-60H & S1656-60H		1628-300*
605 MCM	.953" (24.21 mm)	24 x 7	Peacock		1656-60, 1656-60H & S1656-60H		1628-300*
636 MCM	.940" (23.88 mm)	18 x 1	Kingbird		1656-60, 1656-60H & S1656-60H		1628-300*

*S is for spring. "H" is for hot latch.

*Special order only. Please allow 30 days for delivery. These are not returnable.

For grip details
See pages 270 and 271.

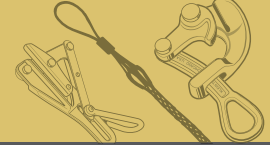

ACSR (Aluminum Conductor Steel Reinforced)



**For Cable Diameter
605 - 2515 MCM
.966" - 1.88" (24.54 mm - 47.75 mm)**

MAXIMUM SAFE LOAD

MCM Cable Size	Diameter inches (mm)	No. of Alum. & Steel Strands	Code Word	MAXIMUM SAFE LOAD		
				D 20,000 lbs (9,072 kg)	E 25,000 lbs (11,340 kg)	F 25,000 lbs. with bolt on jaw (11,340 kg)
				Cat. No.	Cat. No.	Cat. No.
605 MCM	.966" (24.54 mm)	26 x 7	Squab	1628-30P*		1628-50P*
605 MCM	.994" (25.25 mm)	30 x 19	Teal	1628-30P*		1628-50P*
605 MCM	.994" (25.25 mm)	30 x 7	Wood Duck	1628-30P*		1628-50P*
636 MCM	.940" (23.88 mm)	18 x 1	Kingbird	1628-300*		1628-50P*
636 MCM	.977" (24.82 mm)	24 x 7	Rook	1628-30P*		1628-50P*
636 MCM	1.019" (25.88 mm)	30 x 19	Egret	1628-30R*		1628-50R*
636 MCM	1.019" (25.88 mm)	30 x 7	Scoter	1628-30R*		1628-50R*
636 MCM	.991" (25.15 mm)	26 x 7	Grosbeak	1628-30P*		1628-50P*
666.6 MCM	1.00" (25.40 mm)	24 x 7	Flamingo	1628-30P*		1628-50P*
666.6 MCM	1.014" (25.76 mm)	26 x 7	Gannet	1628-30P*		1628-50P*
715.5 MCM	1.051" (26.70 mm)	26 x 7	Starling	1628-30R*		1628-50R*
715.5 MCM	1.081" (27.46 mm)	30 x 19	Redwing	1628-30S*		1628-50S*
795 MCM	1.040" (26.41 mm)	36 x 1	Coot	1628-30R*		1628-50R*
795 MCM	1.063" (27.00 mm)	45 x 7	Tern	1628-30R*		1628-50R*
795 MCM	1.092" (27.76 mm)	54 x 7	Condor	1628-30S*		1628-50S*
795.0 MCM	1.092" (27.74 mm)	24 x 7	Cuckoo	1628-30S*		1628-50S*
795 MCM	1.107" (28.14 mm)	26 x 7	Drake	1628-30S*		1628-50S*
795 MCM	1.140" (28.96 mm)	30 x 19	Mallard	1628-30S*		1628-50S*
900 MCM	1.131" (28.73 mm)	45 x 7	Ruddy	1628-30S*		1628-50S*
900 MCM	1.162" (29.51 mm)	54 x 7	Canary	1628-30T*		1628-50T*
954 MCM	1.165" (29.59 mm)	20 x 7	Corncrake	1628-30T*		1628-50T*
954 MCM	1.165" (29.59 mm)	45 x 7	Rail	1628-30T*		1628-50T*
954 MCM	1.175" (29.85 mm)	48 x 7	Towhee	1628-30T*		1628-50T*
954 MCM	1.196" (30.38 mm)	54 x 7	Cardinal	1628-30T*		1628-50T*
954 MCM	1.196" (30.38 mm)	24 x 7	Redbird	1628-30T*		1628-50T*
1033.5 MCM	1.212" (30.81 mm)	45 x 7	Ortolan	1628-30U*	1628-40U*	1628-50U*
1033.5 MCM	1.245" (31.65 mm)	54 x 7	Curlew	1628-30U*	1628-40U*	1628-50U*
1113 MCM	1.258" (31.95 mm)	45 x 7	Bluejay	1628-30U*	1628-40U*	1628-50U*
1113 MCM	1.292" (32.84 mm)	54 x 19	Finch		1628-40W*	1628-50W*
1192.5 MCM	1.302" (33.07 mm)	45 x 7	Bunting		1628-40W*	1628-50W*
1192.5 MCM	1.337" (33.99 mm)	54 x 19	Grackle		1628-40X*	1628-50X*
1272 MCM	1.317" (33.45 mm)	36 x 1	Skylark		1628-40W*	1628-50W*
1272 MCM	1.345" (34.16 mm)	45 x 7	Bittern		1628-40X*	1628-50X*
1272 MCM	1.381" (35.10 mm)	54 x 19	Pheasant		1628-40X*	1628-50X*
1351.5 MCM	1.386" (35.20 mm)	45 x 7	Dipper		1628-40X*	1628-50X*
1351.5 MCM	1.424" (36.17 mm)	54 x 19	Martin		1628-40Y*	1628-50Y*
1431 MCM	1.427" (36.25 mm)	45 x 7	Bobolink		1628-40Y*	1628-50Y*
1431 MCM	1.465" (37.21 mm)	54 x 19	Plover		1628-40Z*	1628-50Z*
1590 MCM	1.504" (38.15 mm)	45 x 7	Lapwing		1628-40Z*	1628-50Z*
1590 MCM	1.544" (39.24 mm)	54 x 19	Falcon		1628-40A*	1628-50A*
1780 MCM	1.602" (40.69 mm)	84 x 19	Chukar			1628-50B*
2034.5 MCM	1.681" (42.70 mm)	72 x 7	Mockingbird			1628-50C*
2156 MCM	1.762" (44.75 mm)	84 x 19	Bluebird			1628-50D*
2167 MCM	1.735" (44.12 mm)	72 x 7	Kiwi			1628-50D*
2312 MCM	1.802" (45.77 mm)	76 x 19	Thrasher			1628-50E*
2515 MCM	1.88" (47.75 mm)	76 x 19	Joree			1628-50F*

*Special order only. Please allow 30 days for delivery. These are not returnable.

For grip details
See pages 270 and 271.

ACSS (Aluminum Conductor Steel Supported)

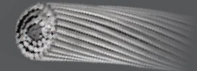

For Cable Diameter

605 - 2515 MCM

.966" - 1.88" (24.54 mm - 47.75 mm)

MAXIMUM SAFE LOAD

F
25,000 lbs.
 (11,340 kg)
 with bolt on jaw

MCM Cable Size	Diameter inches (mm)	No. of Alum. & Steel Strands	Code Word	Cat. No.
605 MCM	.966" (24.54 mm)	26 x 7	Squab/ACSS	1628-50P*
605 MCM	.994" (25.25 mm)	30 x 7	Wood Duck/ACSS	1628-50P*
605 MCM	.994" (25.25 mm)	30 x 19	Teal/ACSS	1628-50P*
636 MCM	.977" (24.82 mm)	24 x 7	Rook/ACSS	1628-50P*
636 MCM	.991" (25.15 mm)	26 x 7	Grosbeak/ACSS	1628-50P*
636 MCM	1.019" (25.88 mm)	30 x 19	Egret/ACSS	1628-50R*
636 MCM	1.019" (25.88 mm)	30 x 7	Scoter/ACSS	1628-50R*
666.6 MCM	1.00" (25.40 mm)	24 x 7	Flamingo/ACSS	1628-50P*
666.6 MCM	1.014" (25.76 mm)	26 x 7	Gannet/ACSS	1628-50P*
715.5 MCM	1.081" (27.46 mm)	30 x 19	Redwing/ACSS	1628-50S*
715.5 MCM	1.051" (26.70 mm)	26 x 7	Starling/ACSS	1628-50R*
795 MCM	1.063" (27.00 mm)	45 x 7	Tern/ACSS	1628-50R*
795 MCM	1.092" (27.74 mm)	24 x 7	Cuckoo/ACSS	1628-50S*
795 MCM	1.092" (27.76 mm)	54 x 7	Condor/ACSS	1628-50S*
795 MCM	1.139" (28.93 mm)	30 x 19	Mallard/ACSS	1628-50S*
795 MCM	1.107" (28.14 mm)	26 x 7	Drake/ACSS	1628-50S*
900 MCM	1.131" (28.73 mm)	45 x 7	Ruddy/ACSS	1628-50S*
900 MCM	1.162" (29.51 mm)	54 x 7	Canary/ACSS	1628-50T*
954 MCM	1.165" (29.59 mm)	20 x 7	Corncrake/ACSS	1628-50T*
954 MCM	1.165" (29.59 mm)	45 x 7	Rail/ACSS	1628-50T*
954 MCM	1.175" (29.85 mm)	48 x 7	Towhee/ACSS	1628-50T*
954 MCM	1.196" (30.38 mm)	54 x 7	Cardinal/ACSS	1628-50T*
954 MCM	1.196" (30.38 mm)	24 x 7	Redbird/ACSS	1628-50T*
954 MCM	1.248" (31.70 mm)	30 x 19	Canvasback/ACSS	1628-50U*
1033.5 MCM	1.212" (30.81 mm)	45 x 7	Ortolan/ACSS	1628-50U*
1033.5 MCM	1.245" (31.65 mm)	54 x 7	Curlew/ACSS	1628-50U*
1113 MCM	1.258" (31.95 mm)	45 x 7	Bluejay/ACSS	1628-50U*
1113 MCM	1.292" (32.84 mm)	54 x 19	Finch/ACSS	1628-50W*
1192.5 MCM	1.302" (33.07 mm)	45 x 7	Bunting/ACSS	1628-50W*
1192.5 MCM	1.337" (33.99 mm)	54 x 19	Grackle/ACSS	1628-50X*
1272 MCM	1.345" (34.16 mm)	45 x 7	Bittern/ACSS	1628-50X*
1272 MCM	1.381" (35.10 mm)	54 x 19	Pheasant/ACSS	1628-50X*
1351.5 MCM	1.386" (35.20 mm)	45 x 7	Dipper/ACSS	1628-50X*
1351.5 MCM	1.424" (36.17 mm)	54 x 19	Martin/ACSS	1628-50Y*
1431 MCM	1.427" (36.25 mm)	45 x 7	Bobolink/ACSS	1628-50Y*
1431 MCM	1.465" (37.21 mm)	54 x 19	Plover/ACSS	1628-50Z*
1590 MCM	1.504" (38.15 mm)	45 x 7	Lapwing/ACSS	1628-50Z*
1590 MCM	1.544" (39.24 mm)	54 x 19	Falcon/ACSS	1628-50A*
1780 MCM	1.602" (40.69 mm)	84 x 19	Chukar/ACSS	1628-50B*
2034.5 MCM	1.681" (42.70 mm)	72 x 7	Mockingbird/ACSS	1628-50C*
2167 MCM	1.735" (44.12 mm)	72 x 7	Kiwi/ACSS	1628-50D*
2156 MCM	1.762" (44.75 mm)	84 x 19	Bluebird/ACSS	1628-50D*
2312 MCM	1.802" (45.77 mm)	76 x 19	Thrasher/ACSS	1628-50E*
2515 MCM	1.88" (47.75 mm)	76 x 19	Joree/ACSS	1628-50F*

Special order only.
 Please allow 30 days for delivery. These are not returnable.

For grip details
 See pages 270 and 271.

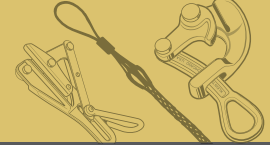

ACSS/TW (Aluminum Conductor Steel Supported/Trapezoidal Wire)



For Cable Diameter

795 - 2627.3 MCM

.960" - 1.762" (24.38 mm - 44.75 mm)

MAXIMUM SAFE LOAD

F

25,000 lbs. (11,340 kg)
with bolt on jaw

MCM Cable Size	Diameter inches (mm)	No. of Alum. & Steel Strands	Code Word	Cat. No
762.8 MCM	.990* (25.15 mm)	20 x 7	Wabash/ACSS/TW	1628-50P*
768.2 MCM	.977* (24.82 mm)	20 x 7	Maumee/ACSS/TW	1628-50P*
795 MCM	.960* (24.38 mm)	17 x 7	Tern/ACSS/TW	1628-50P*
795 MCM	.980* (24.89 mm)	18 x 7	Puffin/ACSS/TW	1628-50P*
795 MCM	.993* (25.22 mm)	20 x 7	Condor/ACSS/TW	1628-50P*
795 MCM	1.010* (25.65 mm)	20 x 7	Drake/ACSS/TW	1628-50P*
946.7 MCM	1.077* (27.36 mm)	35 x 7	Fraser/ACSS/TW	1628-50R*
954.0 MCM	1.044* (26.52 mm)	30 x 7	Phoenix/ACSS/TW	1628-50R*
954.0 MCM	1.061* (26.94 mm)	32 x 7	Rail/ACSS/TW	1628-50R*
954.0 MCM	1.080* (27.43 mm)	20 x 7	Cardinal/ACSS/TW	1628-50S*
957.2 MCM	1.060* (26.92 mm)	32 x 7	Kettle/ACSS/TW	1628-50R*
959.6 MCM	1.110* (28.19 mm)	22 x 7	Suwannee/ACSS/TW	1628-50S*
966.2 MCM	1.092* (27.73 mm)	21 x 7	Columbia/ACSS/TW	1628-50S*
1033.5 MCM	1.089* (27.66 mm)	30 x 7	Snowbird/ACSS/TW	1628-50S*
1033.5 MCM	1.102* (27.99 mm)	32 x 7	Ortolan/ACSS/TW	1628-50S*
1033.5 MCM	1.132* (28.75 mm)	22 x 7	Curlew/ACSS/TW	1628-50S*
1113.0 MCM	1.129* (28.68 mm)	30 x 7	Avocet/ACSS/TW	1628-50S*
1113.0 MCM	1.185* (30.10 mm)	38 x 19	Finch/ACSS/TW	1628-50T*
1113.0 MCM	1.143* (29.03 mm)	33 x 7	Bluejay/ACSS/TW	1628-50T*
1158 MCM	1.165* (29.59 mm)	34 x 7	Genessee/ACSS/TW	1628-50T*
1158.4 MCM	1.196* (30.38 mm)	24 x 7	Hudson/ACSS/TW	1628-50T*
1168.1 MCM	1.155* (29.34 mm)	30 x 7	Cheyenne/ACSS/TW	1628-50T*
1192.5 MCM	1.170* (29.72 mm)	30 x 7	Oxbird/ACSS/TW	1628-50T*
1192.5 MCM	1.181* (29.99 mm)	34 x 7	Bunting/ACSS/TW	1628-50T*
1192.5 MCM	1.225* (31.12 mm)	38 x 19	Grackle/ACSS/TW	1628-50U*
1233.6 MCM	1.245* (31.62 mm)	38 x 19	Yukon/ACSS/TW	1628-50U*
1257.1 MCM	1.213* (30.81 mm)	35 x 7	Nelson/ACSS/TW	1628-50U*
1272 MCM	1.203* (30.56 mm)	30 x 7	Scissortail/ACSS/TW	1628-50T*
1272 MCM	1.203* (30.56 mm)	30 x 7	Catawba/ACSS/TW	1628-50T*
1272 MCM	1.264* (32.11 mm)	39 x 19	Pheasant/ACSS/TW	1628-50U*
1272 MCM	1.220* (30.99 mm)	38 x 7	Bittern/ACSS/TW	1628-50U*
1334.6 MCM	1.290* (32.77 mm)	39 x 19	Thames/ACSS/TW	1628-50W*
1351.5 MCM	1.300* (33.02 mm)	42 x 19	Martin/ACSS/TW	1628-50W*
1351.5 MCM	1.256* (31.90 mm)	35 x 7	Dipper/ACSS/TW	1628-50U*
1359.7 MCM	1.259* (31.98 mm)	36 x 7	Mackenzie/ACSS/TW	1628-50W*
1372.5 MCM	1.248* (31.70 mm)	30 x 7	Truckee/ACSS/TW	1628-50U*
1431 MCM	1.291* (32.79 mm)	36 x 7	Bobolink/ACSS/TW	1628-50W*
1431 MCM	1.337* (33.96 mm)	44 x 19	Plover/ACSS/TW	1628-50X*
1433.6 MCM	1.340* (34.04 mm)	39 x 19	Merrimack/ACSS/TW	1628-50X*
1455.3 MCM	1.302* (33.07 mm)	36 x 7	Miramichi/ACSS/TW	1628-50W*
1467.8 MCM	1.292* (32.82 mm)	33 x 7	St. Croix/ACSS/TW	1628-50W*
1533.3 MCM	1.380* (35.05 mm)	38 x 19	Rio Grande/ACSS/TW	1628-50X*
1557.4 MCM	1.350* (34.29 mm)	36 x 7	Potomac/ACSS/TW	1628-50X*
1569 MCM	1.334* (33.88 mm)	33 x 7	Platte/ACSS/TW	1628-50X*
1590 MCM	1.358* (34.49 mm)	36 x 7	Lapwing/ACSS/TW	1628-50X*
1590 MCM	1.410* (35.81 mm)	42 x 19	Falcon/ACSS/TW	1628-50Y*
1657.4 MCM	1.386* (35.20 mm)	36 x 7	Schuylkill/ACSS/TW	1628-50X*
1622 MCM	1.420* (36.07 mm)	39 x 19	Pecos/ACSS/TW	1628-50Y*
1730.6 MCM	1.470* (37.34 mm)	34 x 19	James/ACSS/TW	1628-50Z*
1758.6 MCM	1.427* (36.25 mm)	38 x 7	Pee Dee/ACSS/TW	1628-50Y*
1780 MCM	1.445* (36.70 mm)	38 x 19	Chukar/ACSS/TW	1628-50Y*
1949.6 MCM	1.504* (38.20 mm)	44 x 7	Athabaska/ACSS/TW	1628-50Z*
1926.9 MCM	1.550* (39.37 mm)	42 x 19	Cumberland/ACSS/TW	1628-50A*
2153.8 MCM	1.602* (40.69 mm)	64 x 19	Powder/ACSS/TW	1628-50B*
2156 MCM	1.608* (40.84 mm)	64 x 19	Bluebird/ACSS/TW	1628-50B*
2627.3 MCM	1.761* (44.73 mm)	64 x 19	Santee/ACSS/TW	1628-50D*

Special order only. Application must be confirmed prior to ordering. Please allow 30 days for delivery

For grip details see pages 270 and 271.

AAC (All Aluminum Conductor)

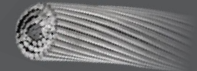

For Cable Diameter
4 AWG - 650 MCM
.231" - .928" (5.87 mm - 23.57 mm)

MAXIMUM SAFE LOAD

AWG or MCM Cable Size	Diameter inches (mm)	No. of Alum. Strands	Code Word	MAXIMUM SAFE LOAD			
				A 4,500 lbs (2041 kg)	B 8,000 lbs (3629 kg)	C 15,000 lbs (6803 kg)	D 20,000 lbs (9072 kg)
				Cat. No.	Cat. No.	Cat. No.	Cat. No.
4	.231" (5.87 mm)	7	Rose	1656-20, 1656-20H and S1656-20H			
2	.292" (7.42 mm)	7	Iris	1656-20, 1656-20H and S1656-20H			
1	.328" (8.33 mm)	7	Pansy	1656-20, 1656-20H, S1656-20H, 1656-30, 1656-30H and S1656-30H			
1/0	.369" (9.36 mm)	7	Poppy	1656-20, 1656-20H, S1656-20H, 1656-30, 1656-30H and S1656-30H			
2/0	.414" (10.51 mm)	7	Aster	1656-30, 1656-30H and S1656-30H			
3/0	.465" (11.81 mm)	7	Phlox	1656-30, 1656-30H and S1656-30H			
4/0	.522" (13.25 mm)	7	Oxlip	1656-30, 1656-30H and S1656-30H			
250 MCM	.567" (14.40 mm)	7	Sneezewort		1656-40, 1656-40H and S1656-40H	1628-16PI*	
250 MCM	.574" (14.58 mm)	19	Valerian		1656-40, 1656-40H and S1656-40H	1628-16PI*	
266.8 MCM	.586" (14.88 mm)	7	Daisy		1656-40, 1656-40H and S1656-40H	1628-16PJ*	
266.8 MCM	.593" (15.05 mm)	19	Laurel		1656-40, 1656-40H and S1656-40H	1628-16PJ*	
300 MCM	.628" (15.95 mm)	19	Peony		1656-40, 1656-40H and S1656-40H	1628-16PJ*	
336.4 MCM	.665" (16.90 mm)	19	Tulip		1656-40, 1656-40H and S1656-40H	1628-16PK*	
350 MCM	.678" (17.22 mm)	19	Daffodil		1656-40, 1656-40H and S1656-40H	1628-16PK*	
397.5 MCM	.724" (18.38 mm)	19	Canna		1656-40, 1656-40H and S1656-40H	1628-16PL*	
450 MCM	.769" (19.53 mm)	19	Goldentuft		1656-50, 1656-50H and S1656-50H	1628-16PM*	
477 MCM	.792" (20.12 mm)	19	Cosmos			1628-16PM*	
477 MCM	.794" (20.18 mm)	37	Syringa			1628-16PM*	
500 MCM	.811" (20.60 mm)	19	Zinnia			1628-16PM*	
500 MCM	.813" (20.65 mm)	37	Hyacinth			1628-16PM*	
556.5 MCM	.856" (21.73 mm)	19	Dahlia			1628-16PN*	1628-30N*
556.5 MCM	.858" (21.80 mm)	37	Mistletoe			1628-16PN*	1628-30N*
600 MCM	.891" (22.63 mm)	37	Meadowsweet				1628-300*
636 MCM	.918" (23.31 mm)	37	Orchid				1628-300*
650 MCM	.928" (23.57 mm)	37	Heuchera				1628-300*

"S" is for spring. "H" is for hot latch.
 *Special order only. Please allow 30 days for delivery. These are not returnable.

For grip details
 See pages 270 and 271.

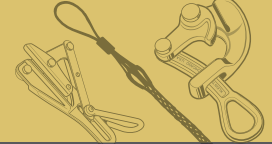

AAC (All Aluminum Conductor)

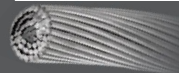

**For Cable Diameter
700 - 2500 MCM
.963" - 1.823" (24.46 mm - 46.30 mm)**

MAXIMUM SAFE LOAD

MCM Cable Size	Diameter inches (mm)	No. of Alum. & Steel Strands	Code Word	MAXIMUM SAFE LOAD		
				D 20,000 lbs (9,072 kg)	E 25,000 lbs (11,340 kg)	F 25,000 lbs. (11,340 kg) with bolt on jaw
				Cat. No.	Cat. No.	Cat. No.
700 MCM	.963" (24.46 mm)	37	Verbena	1628-30P*		1628-50P*
700 MCM	.964" (24.49 mm)	61	Flag	1628-30P*		1628-50P*
715.5 MCM	.974" (24.73 mm)	37	Violet	1628-30P*		1628-50P*
715.5 MCM	.975" (24.76 mm)	61	Nasturtium	1628-30P*		1628-50P*
750 MCM	.997" (25.32 mm)	37	Petunia	1628-30P*		1628-50P*
750 MCM	.998" (25.35 mm)	61	Cattail	1628-30P*		1628-50P*
795 MCM	1.026" (26.07 mm)	37	Arbutus	1628-30R*		1628-50R*
795 MCM	1.028" (26.11 mm)	61	Lilac	1628-30R*		1628-50R*
800 MCM	1.029" (26.14 mm)	37	Fuchsia	1628-30R*		1628-50R*
800 MCM	1.031" (26.19 mm)	61	Heliotrope	1628-30R*		1628-50R*
874.5 MCM	1.076" (27.37 mm)	37	Anemone	1628-30R*		1628-50R*
874.5 MCM	1.077" (27.36 mm)	61	Crocus	1628-30R*		1628-50R*
900 MCM	1.092" (27.74 mm)	37	Cockscomb	1628-30S*		1628-50S*
954 MCM	1.124" (28.55 mm)	37	Magnolia	1628-30S*		1628-50S*
954 MCM	1.126" (28.60 mm)	61	Goldenrod	1628-30S*		1628-50S*
1000 MCM	1.152" (29.26 mm)	61	Camellia	1628-30T*		1628-50T
1000 MCM	1.152" (29.26 mm)	37	Hawkweed	1628-30T*		1628-50T*
1033.5 MCM	1.170" (29.71 mm)	37	Bluebell	1628-30T*		1628-50T*
1033.5 MCM	1.172" (29.76 mm)	61	Larkspur	1628-30T*		1628-50T*
1113 MCM	1.216" (30.88 mm)	61	Marigold	1628-30U*	1628-40U*	1628-50U*
1192.5 MCM	1.258" (31.96 mm)	61	Hawthorn	1628-30U*	1628-40U*	1628-50U*
1272 MCM	1.297" (32.94 mm)	61	Narcissus		1628-40W*	1628-50W*
1351.5 MCM	1.339" (34.02 mm)	61	Columbine		1628-40X*	1628-50X*
1431 MCM	1.379" (35.02 mm)	61	Carnation		1628-40X*	1628-50X*
1510.5 MCM	1.417" (35.98 mm)	61	Gladiolus		1628-40Y*	1628-50Y*
1590 MCM	1.454" (36.93 mm)	61	Coreopsis		1628-40Z*	1628-50Z*
1750 MCM	1.524" (38.72 mm)	61	Jessamine		1628-40A*	1628-50A*
2000 MCM	1.630" (41.41 mm)	91	Cowslip			1628-50B*
2250 MCM	1.729" (43.92 mm)	91	Sagebrush			1628-50D*
2500 MCM	1.823" (46.30 mm)	91	Lupine			1628-50E*

Maximum safe stringing tension 12,500 lbs to minimize cable deformation.

* Special order. Please allow 30 days for delivery. These are not returnable.

For grip details
See pages 270 and 271.

Chicago™ Grips

1656 Series

- Round, smooth inside jaw contour on this series of grips is ideal for bare ACSR
- Smooth jawed grips with maximum contact are less likely to cause cable deformation



1656-30



1656-40

A 4,500 lbs. (2,041 kg) Maximum Safe Load

Cat. No.	Cable Type	Cable Diameter	Hot Latch	Spring	Locking Handle	Jaw Type	Jaw Length	Weight
1656-20	Copper, ACSR, AAC	0.20" to 0.40" (5.08 to 10.16 mm)	—	—	—	Round	4" (101.6 mm)	2.7 lb (1.2 kg)
1656-20H	Copper, ACSR, AAC	0.20" to 0.40" (5.08 to 10.16 mm)	●	—	—	Round	4" (101.6 mm)	3.15 lb (1.43 kg)
S1656-20H	Copper, ACSR, AAC	0.20" to 0.40" (5.08 to 10.16 mm)	●	●	—	Round	4" (101.6 mm)	3.15 lb (1.43 kg)
1656-30	Copper, ACSR, AAC	0.31" to 0.53" (7.87 to 13.46 mm)	—	—	—	Round	4.75" (120.7 mm)	3.4 lb (1.5 kg)
1656-30H	Copper, ACSR, AAC	0.31" to 0.53" (7.87 to 13.46 mm)	●	—	—	Round	4.75" (120.7 mm)	3.95 lb (1.79 kg)
S1656-30H	Copper, ACSR, AAC	0.1" to 0.53" (7.87 to 13.46 mm)	●	●	—	Round	4.75" (120.7 mm)	4 lb (1.81 kg)

B 8,000 lbs. (3,629 kg) Maximum Safe Load

Cat. No.	Cable Type	Cable Diameter	Hot Latch	Spring	Locking Handle	Jaw Type	Jaw Length	Weight
1656-40	ACSR, AAC	0.53" to 0.74" (13.46 to 18.80 mm)	—	—	—	Round	5.5" (139.7 mm)	7.4 lb (3.4 kg)
1656-40H	ACSR, AAC	0.53" to 0.74" (13.46 to 18.80 mm)	●	—	—	Round	5.5" (139.7 mm)	8.5 lb (3.92 kg)
S1656-40H	ACSR, AAC	0.53" to 0.74" (13.46 to 18.80 mm)	●	●	—	Round	5.5" (139.7 mm)	8.65 lb (3.92 kg)
1656-50	ACSR, AAC	0.74" to 0.86" (18.80 to 21.84 mm)	—	—	—	Round	5.5" (139.7 mm)	7.5 lb (3.4 kg)
1656-50H	ACSR, AAC	0.74" to 0.86" (18.80 to 21.84 mm)	●	—	—	Round	5.5" (139.7 mm)	8.45 lb (3.83 kg)
S1656-50H	ACSR, AAC	0.74" to 0.86" (18.80 to 21.84 mm)	●	●	—	Round	5.5" (139.7 mm)	8.45 lb (3.83 kg)
1656-60	ACSR, AAC	0.86" to 0.96" (21.84 to 24.38 mm)	—	—	—	Round	5.5" (139.7 mm)	7.8 lb (3.5 kg)
1656-60H	ACSR, AAC	0.86" to 0.96" (21.84 to 24.38 mm)	●	—	—	Round	5.5" (139.7 mm)	8.4 lb (3.81 kg)
S1656-60H	ACSR, AAC	0.86" to 0.96" (21.84 to 24.38 mm)	●	●	—	Round	5.5" (139.7 mm)	8.36 lb (3.79 kg)

1628-16P Series

- Round jaws are shaped to provide maximum contact with the cable, virtually eliminating cable deformation
- Designed for large-diameter ACSR cables
- These grips are special order only; please allow 30 days for delivery; special order grips are not returnable



1628-16P

C 15,000 lbs. (6,803 kg) Maximum Safe Load

Cat. No.	Cable Type	Cable Diameter	Hot Latch	Spring	Locking Handle	Jaw Type	Jaw Length	Weight
162816PE	Copper, ACSR, AAC	0.31" to 0.33" (7.87 to 8.38 mm)	—	—	—	Round	7.25" (184.2 mm)	17.0 lb (7.7 kg)
162816PF	Copper, ACSR, AAC	0.33" to 0.39" (8.38 to 9.90 mm)	—	—	—	Round	7.25" (184.2 mm)	17.0 lb (7.7 kg)
162816PG	Copper, ACSR, AAC	0.40" to 0.45" (9.93 to 11.50 mm)	—	—	—	Round	7.25" (184.2 mm)	17.0 lb (7.7 kg)
162816PH	Copper, ACSR, AAC	0.46" to 0.52" (11.53 to 13.08 mm)	—	—	—	Round	7.25" (184.2 mm)	17.0 lb (7.7 kg)
162816PI	Copper, ACSR, AAC	0.52" to 0.58" (13.11 to 14.68 mm)	—	—	—	Round	7.25" (184.2 mm)	17.0 lb (7.7 kg)
162816PJ	Copper, ACSR, AAC	0.58" to 0.64" (14.71 to 16.25 mm)	—	—	—	Round	7.25" (184.2 mm)	17.0 lb (7.7 kg)
1628-16PK	Copper, ACSR, AAC	0.64" to 0.70" (16.28 to 17.86 mm)	—	—	—	Round	7.25" (184.2 mm)	17.0 lb (7.7 kg)
162816PL	Copper, ACSR, AAC	0.71" to 0.76" (17.89 to 19.43 mm)	—	—	—	Round	7.25" (184.2 mm)	17.0 lb (7.7 kg)
162816PM	Copper, ACSR, AAC	0.77" to 0.82" (19.46 to 21.03 mm)	—	—	—	Round	7.25" (184.2 mm)	17.0 lb (7.7 kg)
162816PN	Copper, ACSR, AAC	0.83" to 0.89" (21.06 to 22.61 mm)	—	—	—	Round	7.25" (184.2 mm)	17.0 lb (7.7 kg)

The "H" suffix does not indicate Hot Latch for this item.

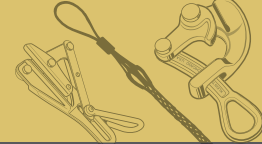

Chicago™ Grips

1628 Series

- Round jaws are shaped to provide maximum contact with the cable, virtually eliminating cable deformation
- These grips are special order only; please allow 30 days for delivery; special order grips are not returnable



1628-30



1628-40

D 20,000 lbs. (9,072 kg) Maximum Safe Load

Cat. No.	Cable Type	Cable Diameter	Hot Latch	Spring	Locking Handle	Jaw Type	Jaw Length	Weight
162830N	ACSR, AAC	0.83" to 0.89" (21.06 to 22.61 mm)	—	—	—	Round	10.75" (273.1 mm)	27.0 lb (12.3 kg)
162830O	ACSR, AAC	0.89" to 0.96" (22.63 to 24.21 mm)	—	—	—	Round	10.75" (273.1 mm)	27.0 lb (12.3 kg)
162830P	ACSR, AAC	0.95" to 1.02" (24.23 to 25.78 mm)	—	—	—	Round	10.75" (273.1 mm)	27.0 lb (12.3 kg)
162830R	ACSR, AAC	1.02" to 1.08" (25.81 to 27.38 mm)	—	—	—	Round	10.75" (273.1 mm)	27.0 lb (12.3 kg)
162830S	ACSR, AAC	1.08" to 1.14" (27.41 to 28.96 mm)	—	—	—	Round	10.75" (273.1 mm)	27.0 lb (12.3 kg)
162830T	ACSR, AAC	1.14" to 1.20" (28.95 to 30.55 mm)	—	—	—	Round	10.75" (273.1 mm)	27.0 lb (12.3 kg)
162830U	ACSR, AAC	1.21" to 1.26" (30.7 to 32 mm)	—	—	—	Round	10.75" (273.1 mm)	27.0 lb (12.3 kg)

E 25,000 lbs. (11,340 kg) Maximum Safe Load

Cat. No.	Cable Type	Cable Diameter	Hot Latch	Spring	Locking Handle	Jaw Type	Jaw Length	Weight
162840U	ACSR, AAC	1.20" to 1.26" (30.48 to 32 mm)	—	—	—	Round	10.75" (273.1 mm)	34.0 lb (15.5 kg)
162840W	ACSR, AAC	1.27" to 1.32" (32.25 to 33.52 mm)	—	—	—	Round	10.75" (273.1 mm)	34.0 lb (15.5 kg)
162840X	ACSR, AAC	1.33" to 1.39" (33.78 to 35.30 mm)	—	—	—	Round	10.75" (273.1 mm)	34.0 lb (15.5 kg)
162840Y	ACSR, AAC	1.39" to 1.45" (35.30 to 36.83 mm)	—	—	—	Round	10.75" (273.1 mm)	34.0 lb (15.5 kg)
162840Z	ACSR, AAC	1.45" to 1.52" (36.83 to 38.6 mm)	—	—	—	Round	10.75" (273.1 mm)	34.0 lb (15.5 kg)
162840A	ACSR, AAC	1.52" to 1.58" (38.6 to 40.13 mm)	—	—	—	Round	10.75" (273.1 mm)	34.0 lb (15.5 kg)

1628 Series

- Removable bolt on floating jaw, secured by a slotted nut and cotter pin. Jaw provides increased cable coverage
- Cat. No. 555 replacement bolt available
- **NOTE:** Jaw must be removed to insert cable
- These grips are special order only; please allow 30 days for delivery; special order grips are not returnable



1628-50

F 25,000 lbs. (11,340 kg) Maximum Safe Load with bolt on jaw

Cat. No.	Cable Type	Cable Diameter	Hot Latch	Spring	Locking Handle	Jaw Type	Jaw Length	Weight
1628-50P	ACSR, ACSS, ACSS-TW, AAC	0.95" to 1.02" (24.23 to 25.78 mm)	—	—	—	Round	10.75" (273.1 mm)	34.0 lb (15.5 kg)
1628-50R	ACSR, ACSS, ACSS-TW, AAC	1.02" to 1.08" (25.91 to 27.43 mm)	—	—	—	Round	10.75" (273.1 mm)	34.0 lb (15.5 kg)
162850S	ACSR, ACSS, ACSS-TW, AAC	1.08" to 1.14" (27.41 to 28.96 mm)	—	—	—	Round	10.75" (273.1 mm)	34.0 lb (15.5 kg)
162850T	ACSR, ACSS, ACSS-TW, AAC	1.14" to 1.20" (28.95 to 30.55 mm)	—	—	—	Round	10.75" (273.1 mm)	34.0 lb (15.5 kg)
162850U	ACSR, ACSS, ACSS-TW, AAC	1.20" to 1.27" (30.48 to 32.25 mm)	—	—	—	Round	10.75" (273.1 mm)	34.0 lb (15.5 kg)
162850W	ACSR, ACSS, ACSS-TW, AAC	1.27" to 1.33" (32.25 to 33.78 mm)	—	—	—	Round	10.75" (273.1 mm)	34.0 lb (15.5 kg)
162850X	ACSR, ACSS, ACSS-TW, AAC	1.33" to 1.39" (33.78 to 35.30 mm)	—	—	—	Round	10.75" (273.1 mm)	34.0 lb (15.5 kg)
162850Y	ACSR, ACSS, ACSS-TW, AAC	1.39" to 1.45" (35.30 to 36.83 mm)	—	—	—	Round	10.75" (273.1 mm)	34.0 lb (15.5 kg)
162850Z	ACSR, ACSS, ACSS-TW, AAC	1.45" to 1.52" (36.83 to 38.6 mm)	—	—	—	Round	10.75" (273.1 mm)	34.0 lb (15.5 kg)
162850A	ACSR, ACSS, ACSS-TW, AAC	1.52" to 1.58" (38.6 to 40.13 mm)	—	—	—	Round	10.75" (273.1 mm)	34.0 lb (15.5 kg)
162850B	ACSR, ACSS, ACSS-TW, AAC	1.58" to 1.64" (40.13 to 41.65 mm)	—	—	—	Round	10.75" (273.1 mm)	34.0 lb (15.5 kg)
162850C	ACSR, ACSS, ACSS-TW, AAC	1.64" to 1.70" (41.65 to 43.18 mm)	—	—	—	Round	10.75" (273.1 mm)	34.0 lb (15.5 kg)
162850D	ACSR, ACSS, ACSS-TW, AAC	1.70" to 1.77" (43.18 to 44.95 mm)	—	—	—	Round	10.75" (273.1 mm)	34.0 lb (15.5 kg)
162850E	ACSR, ACSS, ACSS-TW, AAC	1.77" to 1.83" (44.95 to 46.48 mm)	—	—	—	Round	10.75" (273.1 mm)	34.0 lb (15.5 kg)
162850F	ACSR, ACSS, ACSS-TW, AAC	1.83" to 1.89" (46.48 to 48 mm)	—	—	—	Round	10.75" (273.1 mm)	34.0 lb (15.5 kg)

Chicago™ Grips

Dual Conductor

- Designed specifically for VR2® (vibration-resistant) and TransPowr® T-2® dual conductor twisted pair cables
- Machined upper and lower jaws eliminate scoring or damage to second conductor
- These grips are special order only; please allow 30 days for delivery; special order grips are not returnable

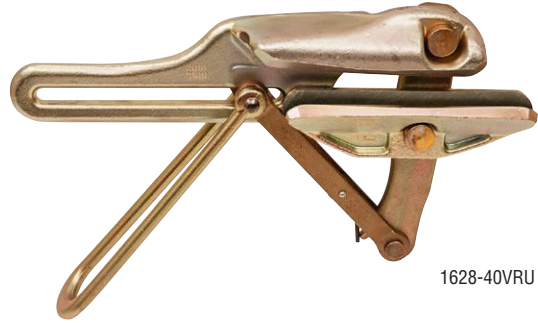

1628-40VRU

Cat. No.	Cable Type	Cable Diameter	Hot Latch	Spring	Locking Handle	Jaw Type	Jaw Length	Weight
15,000 lbs. (6,803 kg) Maximum Safe Load								
162840VRU	ACSR	1.20" to 1.27" (30.5 to 32.3 mm)	—	—	—	Round	10.75" (273.1 mm)	34.0 lb (15.5 kg)
NEW 162830VRP	ACSR	0.95" to 1.02" (24.13 to 25.91 mm)	—	—	—	Round	10.75" (273.1 mm)	27 lb (12.3 kg)

VR2 is a registered trademark of Southwire Company.
TransPowr and T-2 are registered trademarks of General Cable Technologies Corporation.

1613, 1628, 1684, 1686, 1671, 1672 and 1692 Series

- Designed for cable sizes from 0.12" (3.10 mm) to 1" (25.4 mm)
- Double V grooves provide four-point contact, reducing chance of slipping and providing proper alignment of wire and cable. Cat. No. 1684-5F is a Single V with file insert.
- Features an aggressive jaw profile for extra gripping power (Cat. No. 16845C)



 Replacement parts or 1684-5F:
Screws (Cat. No. 573) and
file (Cat. No. 578).



1613-40

Cat. No.	Cable Type	Cable Diameter	Hot Latch	Spring	Locking Handle	Jaw Type	Jaw Length	Weight
4,500 lbs. (2,041 kg) Maximum Safe Load								
1613-40	Aircraft, EHS, Messenger, Guy Strand	0.12" to 0.37" (30.05 to 9.40 mm)	●	—	●	Double V	4.188" (106.4 mm)	2.7 lb (1.2 kg)
1613-40H	Aircraft, EHS, Messenger, Guy Strand	0.12" to 0.37" (30.05 to 9.40 mm)	●	—	●	Double V	4.188" (106.4 mm)	3.15 lb (1.43 kg)
S1613-40H	Aircraft, EHS, Messenger, Guy Strand	0.12" to 0.37" (30.05 to 9.40 mm)	●	●	●	Double V	4.188" (106.4 mm)	3.2 lb (1.4 kg)
8,000 lbs. (3,629 kg) Maximum Safe Load								
1684-5F	Aircraft, EHS, Messenger, Guy Strand	0.16" to 0.55" (4.06 to 13.97 mm)	—	●	●	Single V with File Insert	5" (127.0 mm)	6.4 lb (2.9 kg)
1684-5	Aircraft, EHS, Messenger, Guy Strand	0.218" to 0.55" (5.54 to 13.97 mm)	—	●	●	Double V	5" (127.0 mm)	5.8 lb (2.6 kg)
1684-5H	Aircraft, EHS, Messenger, Guy Strand	0.218" to 0.55" (5.54 to 13.97 mm)	●	—	●	Double V	5" (127.0 mm)	6.5 lb (2.9 kg)
S1684-5H	Aircraft, EHS, Messenger, Guy Strand	0.218" to 0.55" (5.54 to 13.97 mm)	●	●	—	Double V	5" (127.0 mm)	6.7 lb (3.0 kg)
1692-5	Aircraft, EHS, Messenger, Guy Strand	0.218" to 0.55" (5.54 to 13.97 mm)	—	●	●	Double V	5" (127.0 mm)	5.4 lb (2.5 kg)
8,000 lbs. (3,629 kg) Maximum Safe Load – EHS Specific								
16845C	Aircraft, EHS, Messenger, Guy Strand	0.218" to 0.55" (5.54 to 13.97 mm)	—	●	●	Aggressive	5" (127.0 mm)	6.0 lb (2.7 kg)
1684-74	Aircraft, EHS, Messenger, Guy Strand	0.218" to 0.55" (5.54 to 13.97 mm)	—	●	●	Double V, Milled Curved	5" (127.0 mm)	5.6 lb (2.6 kg)
1684-74H	Aircraft, EHS, Messenger, Guy Strand	0.218" to 0.55" (5.54 to 13.97 mm)	●	—	●	Double V, Milled Curved	5" (127.0 mm)	6.3 lb (2.9 kg)
S1684-74H	Aircraft, EHS, Messenger, Guy Strand	0.218" to 0.55" (5.54 to 13.97 mm)	●	●	—	Double V, Milled Curved	5" (127.0 mm)	6.45 lb (2.93 kg)
10,000 lbs. (4,536 kg) Maximum Safe Load								
1686-10	Aircraft, Messenger, Guy Strand	0.20" to 0.40" (5.08 to 10.16 mm)	—	—	—	Double V	4.375" (111.1 mm)	4.6 lb (2.1 kg)
1686-20	Aircraft, Messenger, Guy Strand	0.20" to 0.40" (5.08 to 10.16 mm)	—	—	—	Double V - Serrated	4.375" (111.1 mm)	4.6 lb (2.1 kg)
1671-10	Aircraft, Messenger, Guy Strand	0.37" to 0.75" (9.40 to 19.05 mm)	—	—	—	Double V	4.375" (111.1 mm)	4.3 lb (2.0 kg)
1672-10	Aircraft, Messenger, Guy Strand	0.37" to 0.75" (9.40 to 19.05 mm)	—	—	—	Double V - Serrated	4.375" (111.1 mm)	4.4 lb (2.0 kg)
15,000 lbs. (6,803 kg) Maximum Safe Load								
1628-16	Aircraft, EHS, Messenger, Guy Strand	0.31" to 0.62" (7.87 to 15.75 mm)	—	—	●	Double V	7.25" (184.2 mm)	13.7 lb (6.2 kg)
1628-17	Aircraft, EHS, Messenger, Guy Strand	0.50" to 0.75" (12.70 to 19.05 mm)	—	—	●	Double V	7.25" (184.2 mm)	14.6 lb (6.6 kg)
1628-18	Aircraft, EHS, Messenger, Guy Strand	0.75" to 1.0" (19.05 to 25.40 mm)	—	—	●	Double V	7.25" (184.2 mm)	14.1 lb (6.4 kg)

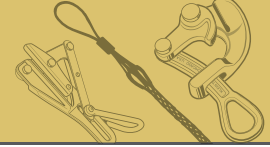

Chicago™ Grips

Weatherproof Stranded and Solid Cable -1611 Series

- Round inside jaw contour for weatherproof coated wire
- Notches in jaw provide firm grip on insulation



1611-30

Cat. No.	Cable Type	Cable Diameter	Hot Latch	Spring	Locking Handle	Jaw Type	Jaw Length	Weight
4,500 lbs. (2,041 kg) Maximum Safe Load								
1611-20	Copper	0.20" to 0.40" (5.08 to 10.16 mm)	—	●	●	Notched	4.188" (106.4 mm)	2.6 lb (1.2 kg)
1611-30	Copper	0.31" to 0.53" (7.87 to 13.46 mm)	—	●	●	Notched	4.75" (120.7 mm)	3.4 lb (1.5 kg)
8,000 lbs. (3,629 kg) Maximum Safe Load								
1611-40	Copper	0.53" to 0.70" (13.46 to 17.78 mm)	—	●	●	Notched	5.688" (144.5 mm)	7.4 lb (3.4 kg)
1611-50	Copper	0.74" to 0.86" (18.80 to 21.84 mm)	—	●	●	Notched	5.688" (144.5 mm)	7.4 lb (3.4 kg)

Due to various types of weatherproof coatings available, selection of proper grips is determined by outside diameter of cable.

Bare Wire-1613 Series

- Designed for working with solid and stranded bare wire from 0.08" (2 mm) to 0.20" (5.1 mm)
- Lightweight, cost-effective grip
- Single "V" groove jaw
- Cat. Nos. 1613-35 and 1613-35H pulls #6 and #8 bare copper wire without damaging or deforming the cable

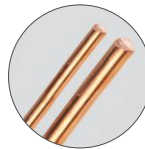

1613-30

Cat. No.	Cable Type	Cable Diameter	Hot Latch	Spring	Locking Handle	Jaw Type	Jaw Length	Weight
1,500 lbs. (680 kg) Maximum Safe Load								
1613-30	Copper, Steel	0.08" to 0.20" (2.03 to 5.08 mm)	—	●	●	Single V	3" (76.2 mm)	1.5 lb (0.7 kg)
4,500 lbs. (2,041 kg) Maximum Safe Load								
1613-35	Copper	#8 to #6 AWG	—	●	●	Single V	4.188" (106.4 mm)	2.9 lb (1.3 kg)
161335H	Copper	#8 to #6 AWG	●	●	●	Single V	4.188" (106.4 mm)	2.8 lb (1.3 kg)

PVC-Covered Cable -1659 Series

- Specially machined serpentine jaws allow insulated conductor to be inserted through jaws
- Eliminates necessity of stripping insulation from conductor
- Round inside-jaw contour



1659-30

Cat. No.	Cable Type	Cable Diameter	Hot Latch	Spring	Locking Handle	Jaw Type	Jaw Length	Weight
4,500 lbs. (2,041 kg) Maximum Safe Load								
1659-20	Copper	0.20" to 0.42" (5.08 to 10.67 mm)	—	●	●	Round - Serpentine	4.188" (106.4 mm)	2.6 lb (1.2 kg)
1659-30	Copper	0.31" to 0.50" (7.87 to 12.70 mm)	—	●	●	Round - Serpentine	4.75" (120.7 mm)	3.3 lb (1.5 kg)
8,000 lbs. (3,629 kg) Maximum Safe Load								
1659-40	Copper	0.49" to 0.79" (12.45 to 20.07 mm)	—	●	●	Round - Serpentine	5.688" (144.5 mm)	7.7 lb (3.5 kg)
1659-50	Copper	0.79" to 1.01" (20.07 to 25.65 mm)	—	●	●	Round - Serpentine	5.688" (144.5 mm)	7.3 lb (3.3 kg)

Chicago™ Grips

Bell System B, L, and H-1628, 1659, 1684 & 1692 Series

- All are equipped with chain, toggle and shackle - keeps the grip from falling off of cable
- 1659-5AT is similar to Bell-System type "B" Strand Puller. Designed to pull 1/4" (6.35 mm) figure-8 telephone cable



1659-5AT

*1692-5AT (larger clamping force than 1684-5AT)

Cat. No.	Cable Type	Cable Diameter	Hot Latch	Spring	Locking Handle	Jaw Type	Jaw Length	Weight
5,000 lbs. (2,268 kg) Maximum Safe Load								
1659-5AT	Steel Strand	0.20" to 0.37" (5.08 to 9.4 mm)	—	●	●	Round - Serpentine	5" (127.0 mm)	6.7 lb (3.03 kg)
8,000 lbs. (3,629 kg) Maximum Safe Load								
1684-5AT	Steel Strand	0.218" to 0.55" (5.54 to 13.97 mm)	—	●	●	Double V	5" (127.0 mm)	6.9 lb (3.12 kg)
NEW 16845CAT	Steel Strand	0.218" to 0.55" (5.54 to 13.97 mm)	—	●	●	Aggressive	5" (127.0 mm)	6.9 lb (3.1 kg)
1692-5AT	Steel Strand	0.218" to 0.55" (5.54 to 13.97 mm)	—	●	●	Double V	5" (127.0 mm)	6.6 lb (2.99 kg)
15,000 lbs. (6,803 kg) Maximum Safe Load								
1628-16AT	Steel Strand	0.31" to 0.62" (7.87 to 15.75 mm)	—	●	●	Double V	7.25" (184.2 mm)	15.8 lb (7.17 kg)

Steel Strand – Haven's™ Grips

1604 Series

- Designed for use when light, compact grip is desired and where cable deformation is not a factor
- Gripping pressure of the knurled jaw is applied to 1/4" (6.35 mm) cable area
- Latch on Cat. No. 1604-20L helps hold cable in the jaw



1604-20



1604-20L

Cat. No.	Cable Type	Cable Diameter	Hot Latch	Spring	Locking Handle	Jaw Type	Weight
2,500 lbs. (1,134 kg) Maximum Safe Load							
1604-10	Messenger and Guy Strand	0.06" to 0.25" (1.52 to 6.35 mm)	—	—	—	Aggressive	0.95 lb (0.43 kg)
5,000 lbs. (2,268 kg) Maximum Safe Load							
1604-20	Messenger and Guy Strand	0.125" to 0.500" (3.18 to 12.70 mm)	—	—	—	Aggressive	2.2 lb (1.0 kg)
1604-20L	Messenger and Guy Strand	0.125" to 0.500" (3.18 to 12.70 mm)	—	—	—	Aggressive	2.60 lb (1.18 kg)

1625 Series

- Designed for use when light, compact grip is desired and where cable deformation is not a factor
- Gripping pressure of the knurled jaw is applied to 1/4" (6.35 mm) cable area
- All 1625 series have a swing latch to help hold cable in the jaw

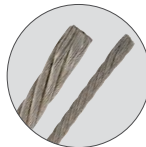

1625-20-114

Cat. No.	Cable Type	Cable Diameter	Hot Latch	Spring	Locking Handle	Jaw Type	Weight
2,000 lbs. (907 kg) Maximum Safe Load							
162520-114	Wire Rope	0.75" to 1.25" (19.05 to 31.75 mm)	—	—	—	Aggressive	3.7 lb (1.7 kg)
8,000 lbs. (3,629 kg) Maximum Safe Load							
1625-20	Wire Rope	0.28" to 0.75" (7.11 to 19.05 mm)	—	—	—	Aggressive	3.5 lb (1.6 kg)
162520-7/8	Wire Rope	0.38" to 0.88" (9.65 to 22.35 mm)	—	—	—	Aggressive	3.4 lb (1.5 kg)
162520-1	Wire Rope	0.50" to 1.00" (12.70 to 25.40 mm)	—	—	—	Aggressive	3.4 lb (1.5 kg)

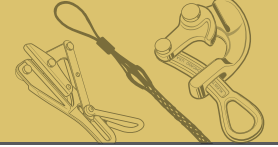

Parallel Jaw Grips

HDPE-Coated Cable

- Securely pulls HDPE-coated cable commonly known as "tree wire"
- Innovative high-traction surface grips the cable without damaging the outer jacket
- Tough carbide grit technology withstands even the harshest jobsite conditions



Cat. No.	Cable Type	Cable Diameter	Hot Latch	Spring	Locking Handle	Jaw Length	Jaw Type	Weight
4,000 lbs. (1,814 kg) Maximum Safe Load								
1716-70	HDPE-Coated	0.625" to 1.362" (15.9 to 34.6 mm)	●	●	—	4.5" (114.3 mm)	Round	5.10 lb (2.31 kg)
NEW 1716-71	HDPE-Coated	0.625" to 1.362" (15.9 to 34.6 mm)	●	●	●	4.5" (114.3 mm)	Round	5.10 lb (2.31 kg)
12,000 lbs. (5,443 kg) Maximum Safe Load								
1716-60	HDPE-Coated	0.70" to 1.30" (17.78 to 33.02 mm)	—	●	—	5.125" (130.2 mm)	Round	8.1 lb (3.7 kg)

KT Series

- Versatile grips hold a wider range of ACSR cable sizes reducing the number of grips needed
- Round jaw provides maximum contact with the cable minimizing deformation
- Large opening in handle accommodates a wide variety of hooks on hoists, winches, and tackle blocks
- Hot latch closes automatically to guard against grip accidentally disengaging from wire
- Spring closes grip on cable helping to maintain initial position
- Locking handle keeps jaw open while grip is placed on cable with a hot stick



KT4500



KT4602



KT4650

Cat. No.	Cable Type	Cable Diameter	Hot Latch	Spring	Locking Handle	Jaw Type	Jaw Length	Weight
5,000 lbs. (2,268 kg) Maximum Safe Load								
KT4500	ACSR	0.18" to 0.60" (4.57 to 15.20 mm)	—	●	—	Round - Serrated	4" (101.6 mm)	3.8 lb (1.7 kg)
KT4501	ACSR	0.18" to 0.60" (4.57 to 15.20 mm)	●	●	●	Round - Serrated	4" (101.6 mm)	3.8 lb (1.7 kg)
KT4502	ACSR	0.18" to 0.60" (4.57 to 15.20 mm)	●	●	—	Round - Serrated	4" (101.6 mm)	3.8 lb (1.7 kg)
KT4650	ACSR	0.16" to 0.90" (4.06 to 22.86 mm)	—	●	—	Round - Serrated	4.5" (114.3 mm)	4.4 lb (2.0 kg)
KT4652	ACSR	0.16" to 0.90" (4.06 to 22.86 mm)	●	●	—	Round - Serrated	4.5" (114.3 mm)	4.9 lb (2.2 kg)
10,000 lbs. (4,536 kg) Maximum Safe Load								
KT4600	ACSR	0.30" to 0.80" (7.62 to 20.3 mm)	—	●	—	Round - Serrated	5" (127.0 mm)	7.0 lb (3.2 kg)
KT4601	ACSR	0.30" to 0.80" (7.62 to 20.3 mm)	●	●	●	Round - Serrated	5" (127.0 mm)	7.0 lb (3.2 kg)
KT4602	ACSR	0.30" to 0.80" (7.62 to 20.3 mm)	●	—	—	Round - Serrated	5" (127.0 mm)	7.0 lb (3.2 kg)
12,000 lbs. (5,443 kg) Maximum Safe Load								
KT4800	ACSR	0.70" to 1.25" (17.78 to 31.75 mm)	—	●	—	Round - Serrated	5.125" (130.2 mm)	9.0 lb (4.1 kg)
KT4801	ACSR	0.70" to 1.25" (17.78 to 31.75 mm)	●	●	●	Round - Serrated	5.125" (130.2 mm)	9.0 lb (4.1 kg)
KT4802	ACSR	0.70" to 1.25" (17.78 to 31.75 mm)	●	—	—	Round - Serrated	5.125" (130.2 mm)	9.0 lb (4.1 kg)

Parallel Jaw Grips

1675 Series

- Versatile grips hold a wider range of ACSR cable sizes reducing the number of grips needed
- Round jaw provides maximum contact with the cable minimizing deformation
- Large opening in handle accommodates a wide variety of hooks on hoists, winches, and tackle blocks
- Hot latch closes automatically to guard against grip accidentally disengaging from wire
- Locking handle keeps jaw open while grip is placed on cable with a hot stick



1675-20

Cat. No.	Cable Type	Cable Diameter	Hot Latch	Spring	Locking Handle	Jaw Type	Jaw Length	Weight
5,000 lbs. (2,268 kg) Maximum Safe Load								
NEW 1675-20	ACSR	0.16" to 0.90" (4.06 to 22.86 mm)	•	•	•	Round - Serrated	5" (127 mm)	7 lb (3.2 kg)
NEW 1675-21	ACSR	0.16" to 0.90" (4.06 to 22.86 mm)	•	•	—	Round - Serrated	5" (127 mm)	7 lb (3.2 kg)

1685 Series

- Lightweight, compact grips pull an exceptionally wide range of cable sizes and types
- Designed with a round inside-jaw contour for maximum contact to minimize conductor damage
- Lower jaw is serrated to firmly grip insulated cables and conductors
- Large-diameter eye accommodates large hooks on hoists, winches and tackle blocks

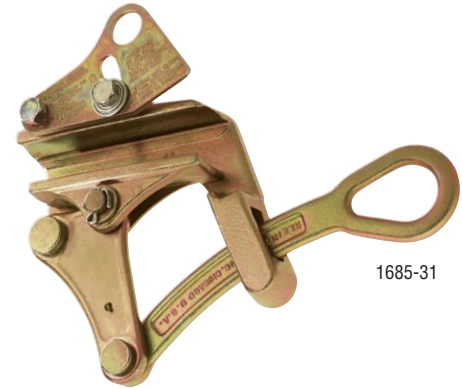

1685-31

Cat. No.	Cable Type	Cable Diameter	Hot Latch	Spring	Locking Handle	Jaw Type	Jaw Length	Weight
1685-20	Messenger, EHS, Coated	0.157" to 0.875" (3.98 to 22.22 mm)	—	•	—	Round - Serrated	2.5" (63.5 mm)	2.6 lb (1.2 kg)
1685-31	Messenger, EHS, Coated	0.625" to 1.250" (15.87 to 31.75 mm)	•	•	—	Round - Serpentine	4.5" (114.3 mm)	4.8 lb (2.2 kg)

Accessories

Grip-Cleaning Brush Set

- Set of four wire-bristle brushes designed for cleaning Klein wire and cable-pulling grips
- Brushes have stiff wire bristles
- Includes round and square shapes in both 12" and 14" (304.8 and 355.6 mm) lengths for efficient cleaning of different jaw configurations
- Semi-flexible steel shafts set into comfortable wooden handles provide the necessary reach into grip jaws



25450

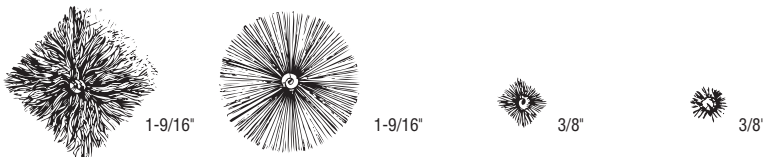

Cat. No.	Weight
25450	1.0 lb (0.5 kg)

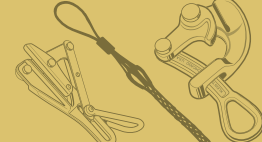

Introduction – Wire Mesh Grips

Klein mesh pulling-grips are used for pulling overhead or underground cable, for stringing service or communication lines into buildings, for pulling wire through conduit, and for general underground construction.

Klein grips may be used for pulling bare or insulated wires, and wire rope. They install quickly and easily, and are designed to pass readily through ducts, conduit, blocks, and sheaves.

Klein grips are reusable and do not damage the cable because pulling tension remains uniform along the length of the grip. The mesh will fit either a single cable, or a bundle of cables.

Klein pulling grips are woven of galvanized steel – strong and long lasting.

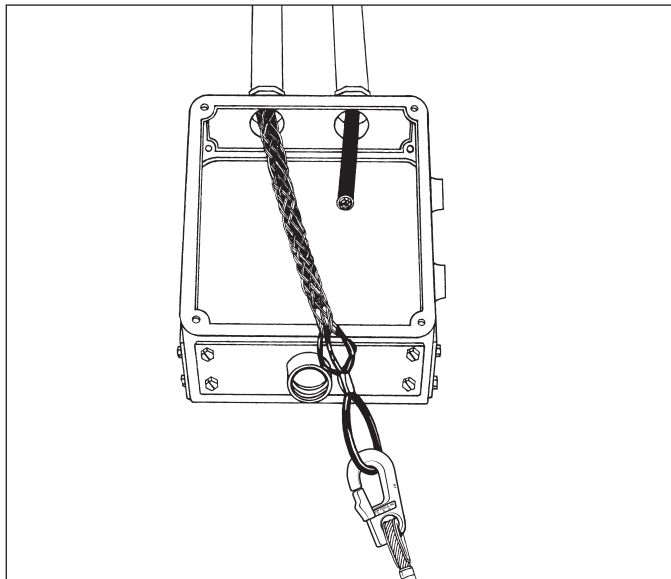

General Application Information

KPJ junior-duty series is used for small-job requirements where pulling tensions are low. Typical uses are to connect insulated building wire bundles to pulling tape, and pull through conduit.

KPL light duty grips are economical for applications such as industrial plant wiring and rewiring jobs, and in underground electrical construction where pulling tensions are low.

KSRK light-duty, slack-pulling grips are split mesh, single-weave design with rod closure for quick installation. Application areas similar to KSSK series, except mesh lengths are shorter and for lower pulling loads.

KPM medium-duty grips are flexible and easily handled; ideal for use where the exceptional strength of heavy-duty grips is not required.

KSCK medium-duty slack-pulling grips with closed double-weave mesh are used for final placement of underground cable where cable end is available, or for removing cable. Standard lengths are used in restricted space for short pulls. Where space is not restricted, longer lengths are used for higher pulling loads.

KSSK medium-duty slack-pulling grip applications are similar to the KSCK series except they are used where cable end is not available. Double-weave split mesh has lace closure.

KP heavy-duty grip series are recommended for underground installations.

KPS heavy-duty grip series are also recommended for underground installations. An additional feature of the KPS includes "rotating eye" to allow twists in the cable to spin out during slack periods.

Prefix Letter Code

KPJ	Pulling, Junior-Duty, Closed-Mesh, Single-Weave, Light Duty, Flexible Eye
KPL	Pulling, Closed-Mesh, Single-Weave, Flexible Eye
KSRK	Slack-Pulling, Light-Duty, Split-Mesh, Single-Weave, Rod Closure, Offset Flexible Eye
KPM	Pulling, Medium-Duty, Closed-Mesh, Double-Weave, Flexible Eye
KSCK	Slack-Pulling, Medium Duty, Closed-Mesh, Double-Weave, Offset Flexible Eye
KSSK	Slack-Pulling, Medium Duty, Split-Mesh, Double-Weave, Lace Closure, Offset Flexible Eye
KP	Pulling, Heavy-Duty, Closed-Mesh, Double-Weave, Flexible Eye
KPS	Pulling, Heavy-Duty, with Rotating Eye, Closed-Mesh, Double-Weave

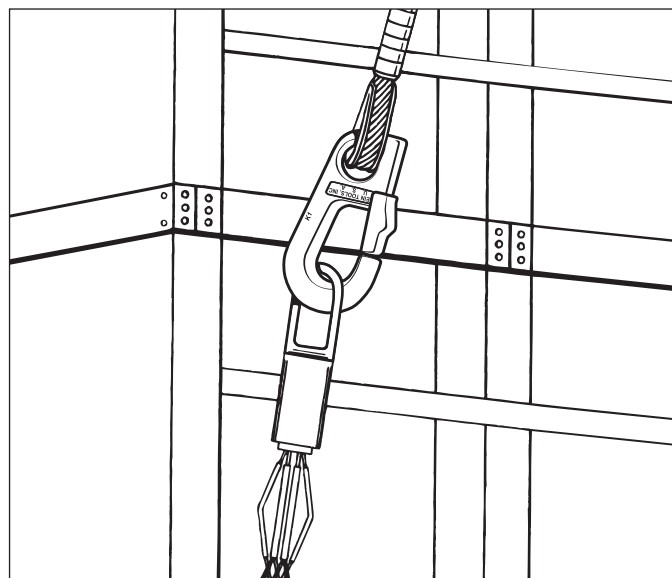

Catalog Number Explanation

KPS	—	050	—	2
Grip Type* and Mesh		Cat. No.** Size Code		Final Digit, if any, refers to mesh length range or actual dimension.

* See Prefix Letter Code explanation.

** On Junior-duty grips, initial digit "0" is omitted in Cat. No.

Example:

Cat. No. KPS-050-2 is a heavy-duty pulling grip with a rotating eye, for use with cable diameters from .50" to .61", with medium-length mesh.

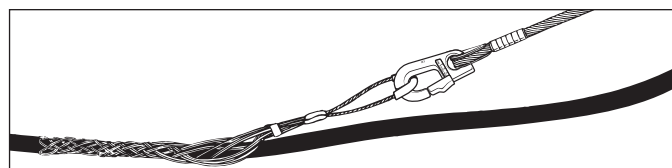

Introduction – Wire Mesh Grips

How to select proper grip eye and mesh type

There are three basic styles of pulling grips, together with a choice of wire mesh types and lengths to meet a wide variety of pulling requirements.

Design Strength

Applications and conditions of use for Klein mesh pulling grips vary so widely that it is impossible to set any meaningful standard for "breaking strength."

With wire-mesh pulling grips, the holding power achieved is directly related to the length of mesh. The longer the mesh, the firmer the grip on the cable. For smaller-diameter cable, or where the weight to be pulled is less, short mesh grips will serve the purpose.

1. Flexible Eye: Closed Mesh

KPJ/KPL/KPM/KP

This pulling-grip eye allows maximum flexibility to follow the line of pull, and is used when the end of the cable is available. Mesh selection depends on the weight of the material being pulled. Closed-mesh, single weave, flexible-eye grips are offered in lengths for junior-duty and light-duty use; closed-mesh, double-weave, flexible-eye grips are offered for medium-duty and heavy-duty use.

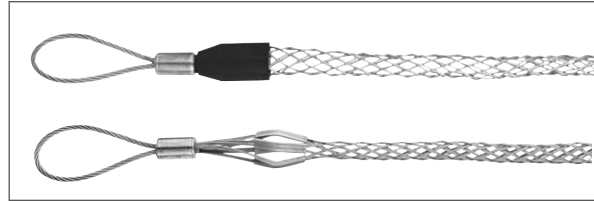

2. Rotating Eye: Closed Mesh

KPS

Recommended for heavier pulling jobs and underground wiring, this pulling grip eye is furnished on double-weave mesh grips in a wide range of lengths. The rotating eye compensates for pulling torque, relieving strain on the cable. **Rotating-eye grips should not be used on rope or as a swivel.**



3. Offset Flexible Eye: Split and Closed Mesh

KSRK/KSCK/KSSK

These slack-pulling grips come in three styles:

KSRK single-weave split-mesh with rod closure (light duty, where cable end is not available),

KSCK double-weave closed-mesh (for medium duty, where the end of the cable is available),

KSSK double-weave split-mesh with lace closure (medium duty, where cable end is not available).

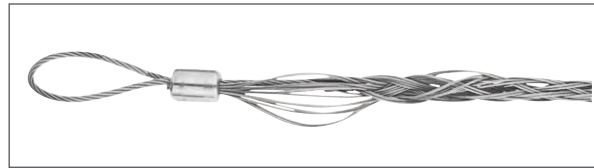

How grips are attached to cable

Closed-mesh grips simply slip over the cable where the cable end is accessible.

Split-mesh grips are used when the end of the cable is not available.

The grip is folded around the cable, and secured with a wire lace or steel rod (supplied with the grip) as follows:

1. Split mesh with lace closure

Start at the lead end of the grip, threading the lace through the first two loops of the split, then pulling it through until ends are centered evenly. Cross the lace ends and thread through next two loops, and so on down the grip. Do not pull lacing too tight. Spacing of laced closure should be about the same as the mesh weave. When the end of the grip is reached, twist lacing strands tightly together; wrap ends of lace around grip, and twist again to secure. Excess may be cut off.

2. Split mesh with rod closure

Simply wrap the grip around the cable, then thread the rod through the loops, using a cork-screw motion.

To remove, pull the rod out, and the grip is ready for re-use.

Wire-Mesh Grips Warnings

⚠ WARNING: Grips are to be used for temporary installation, not for permanent anchorage.

⚠ WARNING: When used on/or near energized lines, ground, insulate, or isolate grip before pulling.

⚠ WARNING: Do not exceed rated capacity.

⚠ WARNING: Always match proper size and type of grip to application.

⚠ WARNING: Before each use, clean jaw area and inspect grip for proper operation to avoid slippage.

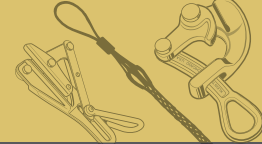

Introduction – Wire Mesh Grips

How to select the proper pulling grip for your application

1. Select the proper pulling-grip series (Prefix Letter Code...e.g. KPS) based on the "General Application Information" descriptions in the Wire-Mesh Grips Introduction on preceding pages.
2. Select grip size based on the outside diameter or circumference of the cable(s) to be pulled. Refer to reference tables (on this and following page) for convenience in determining cable diameters.
3. Use Pulling-Grip Selection Tables (on this and following page) to determine the "Size" portion of the Catalog Number for the cable diameter required. In the ordering tables (see following pages) this "Size" code is incorporated within the catalog number under the various grip-type classifications.

Table 1

Pulling Grip Selection Table for One or More Cables of Equal Diameter to Be Pulled in One Grip

1. Read across on top line for number of cables in one grip.
2. Read down for diameter of each cable.
3. Use Cat. No. size code to select catalog number of the required size grip.

Example:

3 Cables, each with diameter of 1.31" use grip with Cat. No. Size Code 250.

Cable Diameters in Decimal Inches

1 Cable	2 Cables	3 Cables	4 Cables	5 Cables	6 & 7 Cables	8 Cables	9 Cables	Cat. No. Size Code	Grip Diam. Range
0.50-0.62	0.27-0.36	0.26-0.33	0.24-0.28	0.21-0.25	0.19-0.22	0.17-0.20	0.15-0.19	050	0.50-0.62
0.62-0.75	0.36-0.45	0.33-0.36	0.28-0.31	0.25-0.29	0.22-0.26	0.20-0.23	0.19-0.22	062	0.62-0.75
0.75-1.00	0.45-0.60	0.36-0.49	0.31-0.42	0.29-0.38	0.26-0.34	0.23-0.31	0.22-0.31	075	0.75-1.00
1.00-1.25	0.60-0.76	0.49-0.63	0.42-0.54	0.38-0.48	0.34-0.43	0.31-0.39	0.29-0.36	100	1.00-1.25
1.25-1.50	0.76-0.91	0.63-0.76	0.54-0.65	0.48-0.58	0.43-0.52	0.39-0.46	0.36-0.43	125	1.25-1.50
1.50-1.75	0.91-1.08	0.76-0.89	0.65-0.77	0.58-0.67	0.52-0.60	0.46-0.54	0.43-0.49	150	1.50-1.75
2.00-2.50	1.23-1.54	1.02-1.28	0.88-1.10	0.77-0.96	0.69-0.86	0.62-0.77	0.57-0.72	200	2.00-2.50
2.50-3.00	1.54-1.84	1.28-1.53	1.10-1.32	0.96-1.16	0.86-1.03	0.77-0.93	0.72-0.86	250	2.50-3.00
3.00-3.50	1.84-2.15	1.53-1.79	1.32-1.54	1.16-1.35	1.03-1.20	0.93-1.08	0.86-1.00	300	3.00-3.50
3.50-4.00	2.15-2.45	1.79-2.05	1.54-1.76	1.35-1.54	1.20-1.37	1.08-1.24	1.00-1.14	350	3.50-4.00

Table 2

Pulling-Grip Selection Table for Cables of Different Diameters to Be Pulled in One Grip

Grip Circumference Range		Cat. No. Size Code	Grip Diameter Range	
Fractional Inches	Decimal Inches		Fractional Inches	Decimal Inches
1-37/64-1-15/16	1.57-1.94	062	1/2-5/8	.50-.62
1-37/64-2-3/8	1.57-2.37	050	5/8-3/4	.62-.75
2-3/8-3-5/32	2.37-3.15	075	3/4-1	.75-1.00
3-5/32-3-15/16	3.15-3.94	100	1-1-1/4	1.00-1.25
3-15/16-4-23/32	3.94-4.72	125	1-1/4-1-1/2	1.25-1.50
4-23/32-5-33/64	4.72-5.51	150	1-1/2-1-3/4	1.50-1.75
6-19/64-7-55/64	6.29-7.86	200	2-2-1/2	2.00-2.50
7-55/64-9-7/16	7.86-9.43	250	2-1/2-3	2.50-3.00
9-7/16-11-1/64	9.43-11.01	300	3-3-1/2	3.00-3.50
11-1/64-12-37/64	11.01-12.58	350	3-1/2-4	3.50-4.00

"Grip Circumference Range" refers to circumference of all cables held together.

1. Measure the circumference of bundle of cables to be held.
2. Read down to locate correct range.
3. Read across for catalog number size code.

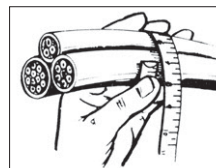

Table 3

Reference Table: Dimension Conversions for Ordering Tables

Decimal Inches	Fractional Inches	Metric Dimensions (mm)
0.12-0.24	1/8-15/64	3.17-5.95
0.25-0.36	1/4-23/64	6.35-9.13
0.37-0.49	3/8-31/64	9.52-12.30
0.50-0.61	1/2-39/64	12.70-15.48
0.62-0.74	5/8-47/64	15.88-18.65
0.75-0.99	3/4-63/64	19.05-25.00
1.00-1.24	1-1-15/64	25.40-31.35
1.25-1.49	1-1/4-1-31/64	31.75-37.70
1.50-1.99	1-1/2-1-63/64	38.10-50.40
2.00-2.49	2-2-31/64	50.80-63.10
2.50-2.99	2-1/2-2-63/64	63.50-75.80
3.00-3.49	3-3-31/64	76.20-88.50
3.50-3.99	3-1/2-3-63/64	88.90-101.20

Example:

For four cables together with circumference of 6.35", use grip containing catalog number size code "200".

*For equivalent cable diameters in fractional inches and in metric dimensions (mm), see Dimensions Conversion Reference Table 3.

Wire Mesh Grips

Single-Weave, Flexible-Eye Pulling Grips



KPJ-50

Cat. No.	Cable Diameter	Mesh Length	Maximum Safe Load	Weight
KPJ50	0.50" to 0.61" (12.70 to 15.59 mm)	8.5" (215.9 mm)	260 lb (118 kg)	0.80 oz (22.7 g)
KPJ75	0.75" to 0.99" (19.05 to 25.15 mm)	10" (254.0 mm)	560 lb (254 kg)	0.10 lb (0.05 kg)
KPJ100	1.00" to 1.24" (25.4 to 31.50 mm)	11.5" (292.1 mm)	780 lb (354 kg)	0.28 lb (0.13 kg)
KPL125-1	1.25" to 1.49" (31.75 to 37.85 mm)	14" (355.6 mm)	1060 lb (481 kg)	0.40 lb (0.18 kg)
KPL150-1	1.50" to 1.74" (38.10 to 44.20 mm)	15" (381.0 mm)	1360 lb (617 kg)	0.40 lb (0.18 kg)
KPL200-1	2.00" to 2.49" (50.80 to 63.25 mm)	18" (457.2 mm)	1700 lb (771 kg)	0.65 lb (0.29 kg)

Double-Weave, Flexible-Eye Pulling Grips



KPM-075

Cat. No.	Cable Diameter	Mesh Length	Maximum Safe Load	Weight
KPM050	0.50" to 0.61" (12.70 to 15.59 mm)	13" (330.2 mm)	480 lb (218 kg)	0.10 lb (0.05 kg)
KPM075	0.75" to 0.99" (19.05 to 25.15 mm)	16" (406.4 mm)	1030 lb (467 kg)	0.20 lb (0.09 kg)
KPM100	1.00" to 1.37" (25.4 to 34.80 mm)	18" (457.2 mm)	1420 lb (644 kg)	0.40 lb (0.18 kg)
KP075-24	0.75" to 0.99" (19.05 to 25.15 mm)	24" (609.6 mm)	1360 lb (617 kg)	0.50 lb (0.23 kg)
KP100-24	1.00" to 1.49" (25.4 to 37.85 mm)	24" (609.6 mm)	1920 lb (871 kg)	1.1 lb (0.5 kg)
KP075-36	0.75" to 0.99" (19.05 to 25.15 mm)	36" (914.4 mm)	1360 lb (617 kg)	0.74 lb (0.34 kg)
KP100-36	1.00" to 1.49" (25.4 to 37.85 mm)	36" (914.4 mm)	1920 lb (871 kg)	1.0 lb (0.5 kg)
KP150-36	1.50" to 1.99" (38.10 to 50.55 mm)	36" (914.4 mm)	3280 lb (1488 kg)	1.6 lb (0.7 kg)

Double-Weave, Rotating-Eye Pulling Grips



KPS-062-1

Cat. No.	Cable Diameter	Mesh Length	Maximum Safe Load	Weight
KPS050-2	0.50" to 0.61" (12.70 to 15.59 mm)	16" (406.4 mm)	1120 lb (508 kg)	0.45 lb (0.20 kg)
KPS062-2	0.620" to 0.740" (15.74 to 18.79 mm)	16" (406.4 mm)	1360 lb (617 kg)	0.50 lb (0.23 kg)
KPS075-2	0.75" to 0.99" (19.05 to 25.15 mm)	20" (508.0 mm)	1360 lb (617 kg)	0.85 lb (0.39 kg)
KPS100-2	1.00" to 1.24" (25.4 to 31.50 mm)	20" (508.0 mm)	2560 lb (1161 kg)	1.9 lb (0.9 kg)
KPS125-2	1.25" to 1.49" (31.75 to 37.85 mm)	21" (533.4 mm)	2560 lb (1161 kg)	1.9 lb (0.9 kg)
KPS150-2	1.50" to 1.99" (38.10 to 50.55 mm)	25" (635.0 mm)	3280 lb (1488 kg)	2.2 lb (1.0 kg)
KPS200-2	2.00" to 2.49" (50.80 to 63.25 mm)	26" (660.4 mm)	5440 lb (2468 kg)	4.1 lb (1.9 kg)
KPS250-2	2.50" to 2.99" (63.50 to 75.95 mm)	28" (711.2 mm)	6600 lb (2994 kg)	5.3 lb (2.4 kg)
KPS300-2	3.00" to 3.49" (76.20 to 88.65 mm)	30" (762.0 mm)	8200 lb (3720 kg)	6.1 lb (2.8 kg)
KPS350-2	3.5" to 3.99" (88.90 to 101.35 mm)	32" (812.8 mm)	9600 lb (4354 kg)	6.8 lb (3.1 kg)
KPS100-3	1.00" to 1.49" (25.4 to 37.85 mm)	33" (838.2 mm)	3280 lb (1488 kg)	2.4 lb (1.1 kg)
KPS150-3	1.50" to 1.99" (38.10 to 50.55 mm)	34" (863.6 mm)	3280 lb (1488 kg)	2.5 lb (1.1 kg)
KPS200-3	2.00" to 2.49" (50.80 to 63.25 mm)	36" (914.4 mm)	5440 lb (2468 kg)	4.7 lb (2.1 kg)

Slack-Pulling, Offset Flexible-Eye Pulling Grips



KSCK-100-1

Cat. No.	Cable Diameter	Mesh Length	Maximum Safe Load	Weight
KSCK100-1	1.00" to 1.24" (25.4 to 31.50 mm)	15" (381.0 mm)	800 lb (363 kg)	0.50 lb (0.23 kg)
KSSK125-1	1.25" to 1.49" (31.75 to 37.85 mm)	16" (406.4 mm)	800 lb (363 kg)	0.25 lb (0.11 kg)



Battery-Operated Tools

Klein brings over 160 years of the quality, durability and expertise in hand tools to battery-operated tools.

This line of cable cutters, crimpers and impact wrench are engineered to help linemen work more efficiently by reducing time and effort on the job.

All with the performance and durability professionals expect from Klein.

POWERED BY

DEWALT[®]

™

DEWALT is a registered trademark of the Black and Decker Corporation.

For Professionals...
Since 1857[™]

Gear-Driven Cable Cutters

- Open- and closed- jaw styles
- Two work lights illuminate dark spaces
- Safety lockout switch
- Powered by DeWALT 20V lithium-ion batteries



COPPER

ALUMINUM

ACSR



BAT20-G1

Cat. No.	Description	Maximum Cable Capacity (Copper)	Maximum Cable Capacity (Aluminum)	Maximum Cable Capacity (ACSR)	Included	Weight
BAT20-G1	Battery-Operated ACSR Closed-Jaw Cutter, 2 Ah	600 MCM	1500 MCM	1590 MCM	(2) 2 Ah Batteries, Charger and Bag	13.2 lb (6.0 kg)
NEW BAT20G14H	Battery-Operated ACSR Closed-Jaw Cutter, 4 Ah	600 MCM	1500 MCM	1590 MCM	(2) 4 Ah Batteries, Charger and Bag	13.2 lb (6.0 kg)
BAT20-G10	Battery-Operated Cu/Al Closed-Jaw Cutter, 2 Ah	750 MCM	1500 MCM	—	(2) 2 Ah Batteries, Charger and Bag	13.3 lb (6.0 kg)
NEW BAT20G104H	Battery-Operated Cu/Al Closed-Jaw Cutter, 4 Ah	750 MCM	1500 MCM	—	(2) 4 Ah Batteries, Charger and Bag	13.3 lb (6.0 kg)
BAT20-G2	Battery-Operated ACSR Open-Jaw Cutter, 2 Ah	400 MCM	900 MCM	795 MCM	(2) 2 Ah Batteries, Charger and Bag	15.3 lb (6.9 kg)
NEW BAT20G24H	Battery-Operated ACSR Open-Jaw Cutter, 4 Ah	400 MCM	900 MCM	795 MCM	(2) 4 Ah Batteries, Charger and Bag	15.3 lb (6.9 kg)
BAT20-G7	Battery-Operated Cu/Al Open-Jaw Cutter, 2 Ah	600 MCM	1000 MCM	—	(2) 2 Ah Batteries, Charger and Bag	15.2 lb (6.9 kg)
Replacement Jaw						
BAT20-G4	Replacement Blades, ACSR Closed-Jaw Cutter	600 MCM	1500 MCM	1590 MCM	—	2.72 lb (1.23 kg)
BAT20-G5	Replacement Blades, ACSR Open-Jaw Cutter	400 MCM	900 MCM	795 MCM	—	4.71 lb (2.14 kg)
BAT20-G8	Replacement Blades, Cu/Al Closed-Jaw Cutter	750 MCM	1500 MCM	—	—	1.66 lb (0.75 kg)
BAT20-G9	Replacement Blades, Cu/Al Open-Jaw Cutter	600 MCM	1000 MCM	—	—	4.60 lb (2.09 kg)

Impact Wrench

- Designed for professional impact fastening and drilling applications
- Up to 500-ft-lb of max torque for driving fasteners into wood, metal and concrete
- 7/16" (11 mm) Quick-Release Chuck
- 0-1900 RPM variable speed trigger
- Safety lockout switch
- Powered by DeWALT 20V lithium-ion batteries



BAT20-7161

Cat. No.	Description	Included	Weight
BAT20-716	Battery-Operated Impact Wrench, 7/16" Tool Only	—	6.3 lb (2.9 kg)
BAT20-7161	Battery-Operated Impact Wrench Kit, 7/16"	(2) 4 Ah Batteries, Charger, Bag and Manual	13.3 lb (6.0 kg)



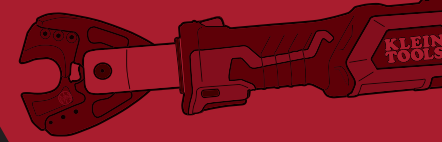

12-Ton Crimper

- 360-degree rotating head for flexibility in crimping positions
- Green light indicates full pressure confirming a good crimp has been made
- Four working lights for dark spaces
- Compatible with industry standard U-Style dies
- Safety lockout switch
- Powered by DeWALT 20V lithium-ion batteries



BAT20-12T1651

Cat. No.	Description	Maximum Cable Capacity (Copper)	Maximum Cable Capacity (Aluminum)	Maximum Cable Capacity (ACSR)	Included	Weight
BAT20-12T165	Battery-Operated 12-Ton Crimper with Case	8 AWG to 750 MCM	8 AWG to 750 MCM	556 MCM	C-Style Head and Case	24.5 lb (11.1 kg)
BAT20-12T1651	Battery-Operated 12-Ton Crimper Kit	8 AWG to 750 MCM	8 AWG to 750 MCM	556 MCM	C-Style Head, (2) Batteries, Charger and Case	28.2 lb (12.8 kg)

7-Ton Combination Cable Cutter/Crimpers

- One tool with 6 heads to meet different job requirements
- Handles copper, aluminum, ACSR, EHS guy strand and steel bolts
- 7-ton hydraulic force provides 15% more cutting and crimping power than similar models on the market
- Compatible with industry standard W-style dies
- Two work lights illuminate darker spaces
- Green light indicator to confirm a good crimp has been made
- Powered by DeWALT 20V lithium-ion batteries, available in 2 Ah and 4 Ah styles



BAT20-7T14

SEE CHART LOCATED ON NEXT PAGE



7-Ton Combination Cable Cutter/Crimpers



Cat. No.	Description	Maximum Cable Capacity (Copper)	Maximum Cable Capacity (Aluminum)	Maximum Cable Capacity (ACSR)	Maximum Cable Capacity (Guy Strand)	Bolt Maximum Capacity	Included	Weight
BAT20-7T	Battery-Operated Cutter/Crimper, Tool Only	—	—	—	—	—	Bag	7.15 lb (3.24 kg)
NEW BAT207T4H	Battery-Op Cut/Crimper, BG Die/D3 Groove/ACSR/EHS	500 MCM	500 MCM	556 MCM	7/16" EHS	3/8" Grade 8	BG and D3 Crimping Jaw, ACSR and EH Cutting Jaw, (2) 4 Ah Batteries, Charger and Bag	25.73 lb (11.7 kg)
BAT207T1	Battery-Operated Crimper, BG Die/D3 Groove, 2 Ah	600 MCM	350 MCM	477 MCM	—	—	BG Fixed Die and D3 Groove Head, (2) 2 Ah Batteries, Charger and Bag	15.7 lb (7.1 kg)
NEW BAT207T14H	Battery-Operated Crimper, BG Die/D3 Groove, 4 Ah	600 MCM	350 MCM	477 MCM	—	—	BG Fixed Die and D3 Groove Head, (2) 4 Ah Batteries, Charger and Bag	17.15 lb (7.8 kg)
BAT207T2	Battery-Operated Cable Crimper, D3 Groove, 2 Ah	600 MCM	350 MCM	477 MCM	—	—	D3 Groove Head, (2) 2 Ah Batteries, Charger and Bag	15.4 lb (7.0 kg)
NEW BAT207T24H	Battery-Operated Cable Crimper, D3 Groove, 4 Ah	600 MCM	350 MCM	477 MCM	—	—	D3 Groove Head, (2) 4 Ah Batteries, Charger and Bag	17.15 lb (7.8 kg)
BAT207T3	Battery-Operated Cable Cutter, Cu/Al, 2 Ah	750 MCM	1000 MCM	—	—	—	Cutting Jaw, (2) 2 Ah Batteries, Charger and Bag	15.74 lb (7.14 kg)
NEW BAT207T34H	Battery-Operated Cable Cutter, Cu/Al, 4 Ah	750 MCM	1000 MCM	—	—	—	Cutting Jaw, (2) 4 Ah Batteries, Charger and Bag	17.19 lb (7.8 kg)
BAT207T4	Battery-Operated Cable Cutter, ACSR, 2 Ah	500 MCM	500 MCM	556 MCM	—	—	Cutting Jaw, (2) 2 Ah Batteries, Charger and Bag	16.03 lb (7.27 kg)
NEW BAT207T44H	Battery-Operated Cable Cutter, ACSR, 4 Ah	500 MCM	500 MCM	556 MCM	—	—	Cutting Jaw, (2) 4 Ah Batteries, Charger and Bag	17.15 lb (7.8 kg)
BAT207T5	Battery-Operated Bolt Cutter, Steel, 2 Ah	—	—	—	7/16" EHS	3/8" Grade 8	Cutting Jaw, (2) 2 Ah Batteries, Charger and Bag	15.9 lb (7.2 kg)
NEW BAT207T54H	Battery-Operated Bolt Cutter, Steel, 4 Ah	—	—	—	7/16" EHS	3/8" Grade 8	Cutting Jaw, (2) 4 Ah Batteries, Charger and Bag	17.35 lb (7.9 kg)
BAT207T13	Battery-Operated Cutter/Crimper, No Heads, 2 Ah	—	—	—	—	—	(2) 2 Ah Batteries, Charger and Bag	12.49 lb (5.67 kg)
NEW BAT207T134H	Battery-Operated Cutter/Crimper, No Heads, 4 Ah	—	—	—	—	—	(2) 4 Ah Batteries, Charger and Bag	13.72 lb (6.2 kg)
BAT20-7T14	Battery-Operated Cable Cutter/Crimper Kit, 2 Ah	750 MCM	1000 MCM	556 MCM	7/16" EHS	3/8" Grade 8	(3) Cutting Jaws, (3) Crimping Jaws, (2) 2 Ah Batteries, Charger and Bag	32.1 lb (14.6 kg)
NEW BAT207T144H	Battery-Operated Cable Cutter/Crimper Kit, 4 Ah	750 MCM	1000 MCM	556 MCM	7/16" EHS	3/8" Grade 8	(3) Cutting Jaws, (3) Crimping Jaws, (2) 4 Ah Batteries, Charger and Bag	33.5 lb (15.2 kg)
BAT207T23	Battery-Operated Cable Crimper, O+ Die Head, 2 Ah	600 MCM	350 MCM	477 MCM	—	—	O Fixed Die/D3 Groove Crimping Jaw, (2) 2 Ah Batteries, Charger and Bag	15.7 lb (7.1 kg)
NEW BAT207T234H	Battery-Operated Cable Crimper, O+ Die Head, 4 Ah	600 MCM	350 MCM	477 MCM	—	—	O Fixed Die/D3 Groove Crimping Jaw, (2) 4 Ah Batteries, Charger and Bag	17.15 lb (7.8 kg)
Replacement Jaw								
BAT207T6	Crimping Jaw, Fixed BG Die/D3 Groove	600 MCM	350 MCM	477 MCM	—	—	—	3.2 lb (1.5 kg)
BAT207T7	Crimping Jaw, D3 Groove	600 MCM	350 MCM	477 MCM	—	—	—	2.9 lb (1.3 kg)
BAT20-7T12	Crimping Jaw, Fixed O Die/D3 Groove	600 MCM	350 MCM	477 MCM	—	—	—	3.18 lb (1.44 kg)
BAT207T9	Cutting Jaw, Cu/Al	750 MCM	1000 MCM	—	—	—	—	3.2 lb (1.5 kg)
BAT207T10	Cutting Jaw, ACSR	500 MCM	500 MCM	556 MCM	—	—	—	3.5 lb (1.6 kg)
BAT20-7T11	Cutting Jaw, Steel	—	—	—	7/16" EHS	3/8" Grade 8	—	3.5 lb (1.6 kg)
Replacement Blades								
BAT207T16	Replacement Blade, Cu/Al Cutting Head	750 MCM	1000 MCM	—	—	—	—	0.35 lb (0.2 kg)
BAT207T17	Replacement Blade, ACSR Cutting Head	500 MCM	500 MCM	556 MCM	—	—	—	0.40 lb (0.2 kg)
BAT207T18	Replacement Blade, Steel Cutting Head	—	—	—	7/16" EHS	3/8" Grade 8	—	0.40 lb (0.2 kg)





Hammers, Chisels & Punches

Klein hammers, chisels and punches are designed and created to strike through jobsite challenges. Engineered with the professional in mind, each tool is job-matched to fit the task at hand.

For Professionals...
Since 1857™

Hammers

Claw Hammers

- Durable plastic-alloy jacketing helps to protect neck from fraying and splintering if incorrectly struck or overstruck
- High-strength fiberglass shaft absorbs shock and keeps head tight
- Comfortable, perforated neoprene grip bonded to handle
- Extra-long neck, narrow striking face and balanced design are ideal for reaching into outlet boxes (Cat. No. 807-18)
- Straight claw design for easy nail pulling in tight quarters (Cat. Nos. 807-18, 808-16 and 808-20)
- Curved claw gives maximum nail-pulling leverage (Cat. Nos. 818-16 and 818-20)



807-18



818-16

Cat. No.	Overall Length	Head Weight	Weight
807-18	15" (381.0 mm)	18.0 oz (510 g)	1.9 lb (0.8 kg)
808-16	13" (330.2 mm)	16.0 oz (454 g)	1.9 lb (0.8 kg)
808-20	14" (355.6 mm)	20.0 oz (567 g)	2.0 lb (0.9 kg)
818-16	13" (330.2 mm)	16.0 oz (454 g)	1.9 lb (0.8 kg)
818-20	14" (355.6 mm)	20.0 oz (567 g)	2.0 lb (0.9 kg)

Lineman's Straight-Claw Hammer

- Heavy-duty, double-duty hammer drives lags and pulls large nails
- Special high-carbon steel head with solid, octagon-shaped driving end and thick, strong claw
- Straight-grain hickory handle, lacquered to withstand weather



832-32

Cat. No.	Overall Length	Head Weight	Weight
832-32	15" (381.0 mm)	32.0 oz (907 g)	2.5 lb (1.1 kg)

Lineman's Double-Face Hammer

- Designed for pole-line work
- Rugged and well-balanced, with the weight to drive lag bolts
- Faces with 1-3/4" (44 mm) round-crown driving surface and beveled edges
- One milled face for driving staples used in pole-line work and common, unhardened nails (Cat. No. 809-36MF)
- Forged, tempered-steel head is only 3-3/4" (95 mm) long for use in tight areas



809-36

Cat. No.	Overall Length	Head Weight	Weight
809-36	14" (355.6 mm)	36 oz (1021 g)	2.5 lb (1.1 kg)
809-36MF	14" (355.6 mm)	36 oz (1021 g)	2.5 lb (1.1 kg)

809-36
both sides

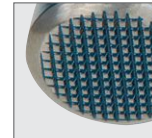

809-36MF
one side



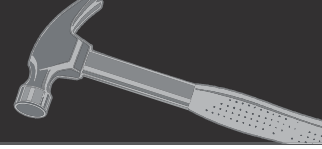

Hammers

Ball-Peen Hammers

- Forged high-carbon steel head is hardened for additional durability
- Crowned face with uniform bevel
- Smoothly rounded peen
- Straight-grain hickory handle is stained and lacquered to withstand weather

Cat. No.	Overall Length	Head Weight	Weight
803-8	11.5" (292.1 mm)	8.0 oz (227 g)	0.75 lb (0.34 kg)
803-12	12.5" (317.5 mm)	12.0 oz (340 g)	1.1 lb (0.5 kg)
803-16	13.5" (342.9 mm)	16.0 oz (454 g)	1.4 lb (0.6 kg)
803-24	15" (381.0 mm)	24.0 oz (680 g)	1.9 lb (0.9 kg)
803-32	15" (381.0 mm)	32.0 oz (907 g)	2.5 lb (1.1 kg)



803-12

Hand-Drilling Hammer

- Extra-heavy, forged steel head, hardened and tempered
- Short handle for working in close quarters
- Select hickory handle is triple-wedged and lacquered to withstand weather
- Special handle treatment removes handle moisture and replaces it with oil to help eliminate the effects of extreme temperatures

Cat. No.	Overall Length	Head Weight	Weight
823-48	10" (254.0 mm)	48 oz (1361 g)	3.3 lb (1.5 kg)



823-48

Setting Hammer

- Durable epoxy resin handle helps to protect neck from fraying and splintering if incorrectly struck or over struck
- High-strength fiberglass shaft absorbs shock and keeps head tight
- Cushioned, PVC grip bonded to handle
- Special high-carbon steel, octagon shaped head with flat striking surface and rounded cross peen

Cat. No.	Overall Length	Head Weight	Weight
820-16	13" (330.2 mm)	16.0 oz (454 g)	1.6 lb (0.7 kg)



820-16

Riveting Hammer

- High-carbon steel round head is forged and hardened
- Flat striking surface with rounded cross peen
- Straight-grain American hickory handle is stained and lacquered

Cat. No.	Overall Length	Head Weight	Weight
821-12	12.25" (311.2 mm)	12.0 oz (340 g)	1.1 lb (0.5 kg)



821-12

See page 297 for additional information on warnings.



Hammers

Non-Sparking Hammers

- Brass-head hammers are non-sparking, non-marring
- Fiberglass handle includes TPR overmold for extra comfort and shock absorption
- Built-in overstrike protector absorbs shock and vibration when overstrike occurs
- Large sweep at base prevents loss of grip
- Head is securely epoxied to prevent detachment
- Does not contain beryllium



819-03

Cat. No.	Overall Length	Head Weight	Weight
819-03	15.75" (400.1 mm)	3.0 lb (1.4 kg)	3.1 lb (1.4 kg)
819-04	16" (406.4 mm)	4.0 lb (1.8 kg)	4.1 lb (1.8 kg)

Dead Blow Hammers

- Durable, abrasion resistant non-marring hammer face
- Increased striking force with zero impact rebound
- Design isolates user from striking impact and reduces fatigue
- 40% more driving power than other dead blow hammers
- Protects job surface from damage
- Applications: HVAC, metal fabrication, electronics, oil and mining, wood and metal assembly, automotive, aerospace



811-16

Cat. No.	Overall Length	Head Weight	Weight
811-16	12.5" (317.5 mm)	16.0 oz (454 g)	1.4 lb (0.7 kg)
811-32	18" (457.2 mm)	32.0 oz (907 g)	1.8 lb (0.8 kg)

Brass Sledge Hammers - Fiberglass Rubber Grip Handle



7HBRFRH14

- Used in non-sparking environments or to avoid damage to struck objects
- Head forged from brass for softer, non-damaging blow
- Head is pinned to handle as well as epoxied to prevent head coming off
- Comfortable, thick rubber grip handle for increased protection from shock and vibration
- Handle includes both overstrike protection and large sweep at base to prevent loss of grip

Cat. No.	Overall Length	Head Weight	Weight
7HBRFRH07	32" (812.8 mm)	7.0 lb (3.2 kg)	9.9 lb (4.5 kg)
7HBRFRH10	36" (914.4 mm)	10.0 lb (4.5 kg)	12.2 lb (5.6 kg)
7HBRFRH04	16" (406.4 mm)	4.0 lb (1.8 kg)	4.9 lb (2.2 kg)
7HBRFRH14	36" (914.4 mm)	14.0 lb (6.4 kg)	16.7 lb (7.6 kg)



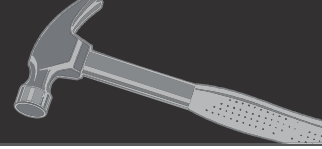

Chisels

Cold Chisels

- Heat-treated, high-carbon steel for necessary hardness and durability
- Cuts, shapes and removes metal
- Corrosion-resistant black finish
- Long length works better in hard-to-reach areas (Cat. Nos. 66174, 66177 and 66183)

Cat. No.	Overall Length	Blade Width	Weight
66140	5" (127.0 mm)	0.375" (9.5 mm)	0.10 lb (0.05 kg)
66142	6" (152.4 mm)	0.5" (12.7 mm)	0.20 lb (0.09 kg)
66143	6.5" (165.1 mm)	0.625" (15.9 mm)	0.35 lb (0.16 kg)
66144	7.5" (190.5 mm)	0.75" (19.1 mm)	0.60 lb (0.27 kg)
66145	8" (203.2 mm)	0.875" (22.2 mm)	0.85 lb (0.39 kg)
66146	8.5" (215.9 mm)	1" (25.4 mm)	1.3 lb (0.6 kg)
66174	12" (304.8 mm)	0.5" (12.7 mm)	0.40 lb (0.18 kg)
66177	12" (304.8 mm)	0.75" (19.1 mm)	1.1 lb (0.5 kg)
66183	12" (304.8 mm)	1" (25.4 mm)	2.1 lb (0.9 kg)



Electrician's Chisel

- One-piece handle and blade forged of strong alloy steel
- Corrosion-resistant black finish extends to the polished blade edge

Cat. No.	Overall Length	Blade Width	Weight
66100	8" (203.2 mm)	2.75" (69.9 mm)	1.1 lb (0.5 kg)



Safety Punches & Tire Levers

Wire Rope Punches

- Used to safely drive out pins and keys in machinery
- Long, two-handed rubber handle to lessen shocks from blows
- Head attached with wire rope to reduce shock
- Urethane ring around head to reduce likelihood of chipping
- Heat-treated so it will not shatterPrecision heat treated to prevent shattering

Cat. No.	Point Diameter	Shank Length	Overall Length	Weight
7WRP13	1/2" (12.7 mm)	4.75" (120.7 mm)	20" (508.0 mm)	3.0 lb (1.4 kg)
7WRP16	5/8" (15.9 mm)	4.75" (120.7 mm)	20" (508.0 mm)	3.2 lb (1.5 kg)
7WRP19	3/4" (19.1 mm)	4.75" (120.7 mm)	20" (508.0 mm)	3.6 lb (1.7 kg)
7WRP22	7/8" (22.2 mm)	4.75" (120.7 mm)	20" (508.0 mm)	4.4 lb (2.0 kg)
7WRP25	1" (25.4 mm)	4.75" (120.7 mm)	20" (508.0 mm)	4.6 lb (2.1 kg)
7WRP32	1-1/4" (31.8 mm)	4.75" (120.7 mm)	20" (508.0 mm)	5.3 lb (2.4 kg)



Punches

Brass Punches

- Used where a softer punch is needed, e.g. where damage may occur from using a hardened punch
- Selected brass, correct composition for punch use
- Knurled handle for gripping easily
- Chamfered head for safety



4BPSET5

Cat. No.	Set Contains	Weight
4BPSET5		4.4 lb (2.0 kg)
Cat. No.	Point Diameter	Overall Length
4BP10	3/8" (9.5 mm)	6" (152.4 mm)
4BP12	1/2" (12.7 mm)	7" (177.8 mm)
4BP16	5/8" (15.9 mm)	7" (177.8 mm)
4BP19	3/4" (19.1 mm)	8" (203.2 mm)
4BP25	1" (25.4 mm)	8" (203.2 mm)

Center Punches



66313

- High-carbon steel for durability
- Rugged design for impact strength
- Smooth-ground points heat-treated to stay sharp and true longer
- Corrosion-resistant black finish

Cat. No.	Point Diameter	Overall Length	Weight
66310	1/4" (6.4 mm)	4.25" (108 mm)	0.80 oz (22.7 g)
66311	5/16" (7.9 mm)	4.5" (114.3 mm)	0.10 lb (0.05 kg)
66312	3/8" (9.5 mm)	5" (127.0 mm)	0.10 lb (0.05 kg)
66313	1/2" (12.7 mm)	6" (152.4 mm)	0.25 lb (0.11 kg)

Drift Punches



66343

- High-carbon steel for durability
- Rugged design for impact strength
- Strong, heat-treated points are smooth and precision tapered
- Corrosion-resistant black finish

Cat. No.	Point Diameter	Shank Length	Overall Length	Weight
66340	1/8" (3.18 mm)	4.25" (108 mm)	8" (203.2 mm)	0.20 lb (0.09 kg)
66342	3/16" (4.76 mm)	5" (127.0 mm)	9" (228.6 mm)	0.35 lb (0.16 kg)
66343	1/4" (6.4 mm)	5.5" (139.7 mm)	11" (279.4 mm)	0.75 lb (0.34 kg)
66344	5/16" (7.9 mm)	5.5" (139.7 mm)	11" (279.4 mm)	0.75 lb (0.34 kg)

Pin Punches

- Used for driving out and removing pins and keys
- Tough and resilient shaft made from quality tool steel
- Heat treated for durability and strength
- Soft head for safety; will mushroom, not chip
- Knurled handle for gripping easily



4PPLSET8

Cat. No.	Set Contains	Weight
4PPLSET8		1.5 lb (0.7 kg)
Cat. No.	Point Diameter	Overall Length
4PPL02.5	3/32" (2.4 mm)	2.156" (54.8 mm)
4PPL03	7/64" (2.8 mm)	2.156" (54.8 mm)
4PPL04	5/32" (4.0 mm)	2.359" (59.9 mm)
4PPL05	3/16" (4.8 mm)	2.547" (64.7 mm)
4PPL06	15/64" (6.0 mm)	2.547" (64.7 mm)
4PPL06.5	1/4" (6.4 mm)	2.547" (64.7 mm)
4PPL08	5/16" (7.9 mm)	2.75" (69.9 mm)
4PPL10	25/64" (9.9 mm)	2.75" (69.9 mm)

Pin Punches



66324

- High-carbon steel for durability
- Precision-ground shank
- Heat-treated for added strength and hardness at working end
- Corrosion-resistant black finish

Cat. No.	Point Diameter	Overall Length	Weight
66320	1/16" (1.59 mm)	4.25" (108 mm)	0.80 oz (22.7 g)
66321	3/32" (2.4 mm)	4.75" (120.7 mm)	0.10 lb (0.05 kg)
66322	1/8" (3.18 mm)	5" (127.0 mm)	0.10 lb (0.05 kg)
66323	5/32" (3.97 mm)	5.25" (133.4 mm)	0.10 lb (0.05 kg)
66324	3/16" (4.76 mm)	5.5" (139.7 mm)	0.10 lb (0.05 kg)
66325	1/4" (6.4 mm)	7" (177.8 mm)	0.20 lb (0.09 kg)





Steel & Concrete Construction Tools



Klein has combined unique design features with skillful engineering and manufacturing to create a superior line of steel construction tools. These tools are exceptionally rugged, with a long usage life.

For Professionals...
Since 1857™

Construction Tools

Tie-Wire Reel

- Klein's redesigned tie-wire reel allows loading pre-coiled tie wire onto the reel without having to remove the cover
- Rugged, lightweight reel is smooth aluminum alloy with wear parts made of steel
- Designed for left or right hand use
- Large, comfortable rewind knob



27400

Cat. No.	Overall Width	Dimensions	Weight
27400	2.781" (70.6 mm)	6-1/4" (158.8 mm) Diameter x 2-25/32" (70.6 mm) Width	2.4 lb (1.1 kg)

Tie-Wire Reel Pad

- Worn on the belt under the Klein® tie-wire reel (Cat. No. 27400)
- Made of 3/16" (5 mm) thick rigging leather
- Underside has a sponge-rubber pad to minimize hip fatigue



27450

Cat. No.	Belt Connection	Belt Width	Overall Length	Overall Width	Overall Height	Weight
27450	Slotted	Up to 2" (50.8 mm)	7" (177.8 mm)	7" (177.8 mm)	0.75" (19.1 mm)	0.30 lb (0.14 kg)

Tie-wire reel and ironworker's heavy-duty tie-wire belts also available.

Iron Worker's Heavy Duty Tie-Wire Belt

- Strong double-tongue buckle with keeper
- Has separate reel-strap with its own buckle that lets you quickly and conveniently put on or take off a Klein tie-wire reel and optional pad without removing the belt or your tool pouch
- Leather construction



5420L

Cat. No.	Overall Width	Waist Size	Weight
5420S	2" (50.8 mm)	32" to 40" (81.3 to 101.6 cm)	0.85 lb (0.39 kg)
5420	2" (50.8 mm)	36" to 44" (91.4 to 111.8 cm)	0.95 lb (0.43 kg)
5420L	2" (50.8 mm)	40" to 48" (101.6 to 121.9 cm)	1.1 lb (0.5 kg)
5420XL	2" (50.8 mm)	44" to 52" (111.8 to 132.1 cm)	1.2 lb (0.5 kg)

Rebar Hickeys

- Lightweight rebar hickey has exceptionally durable steel-alloy head and extra-strong handle to withstand extreme conditions



64310

Cat. No.	Hickey Size	Bends	Bend Angle	Handle Length	Weight
64309	1a	Rebar Sizes No. 3 - 0.375" (9.525 mm) Dia. and No. 4 - 0.500" (12.700 mm) Dia.	Double 65° and 90°	24" (609.6 mm)	3.5 lb (1.6 kg)
64310	2	Rebar Sizes No. 5 - 0.625" (15.875 mm) Dia.	Single 65°	40" (101.6 cm)	7.5 lb (3.4 kg)
64311	3	Rebar Sizes No. 6 - 0.750" (19.050 mm) Dia.	Single 65°	40" (101.6 cm)	8.0 lb (3.6 kg)
64312	4	Rebar Sizes No. 7 - 0.875" (22.225 mm) Dia., No. 8 - 1.000" (25.400 mm) Dia., and No. 9 - 1.128" (28.651 mm) Dia.	Single 65°	60" (152.4 cm)	16.4 lb (7.4 kg)

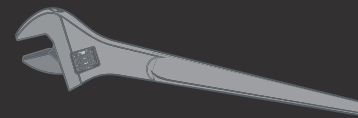

Construction Tools

Grizzly™ Bar



64306

- A heavy, strong, multi-purpose tool that saves time and effort on the job
- The 3" (76.2 mm) width protects concrete when stripping forms
- Efficient blade angle and 55-1/2" (1409.7 mm) total length provide high leverage as a crow bar, as well as a nail and spike puller
- Blade is forged and hardened alloy with keyhole nail-pulling slot in center and "V" notch in tapered edge
- Can be used to help align walls during tilt-up construction, to roll and align large pipe, to remove shingles and flooring, and for many other stripping and prying tasks

Cat. No.	Overall Length	Body Diameter	End	Weight
64306	55-1/2" (1410 mm)	1-1/2" (38.1 mm)	60°	12.0 lb (5.4 kg)

⚠WARNING: Always wear approved personal protective equipment.

Fox Wedges

- Used for splitting mating surfaces and for packing machinery and structures before fixing
- Also used in the marine environment because of its corrosion-resistant properties
- Forged from stainless steel for greater hardness and non-magnetic properties
- Ground blade with fine edge for easy entry
- Precision heat treated to best suit product application



7FWSS10025

Cat. No.	Overall Length	Overall Width	Material	Thickness	Weight
5FW07538	3" (76.2 mm)	1.5" (38.1 mm)	Stainless Steel	1/2" (12.7 mm)	0.35 lb (0.16 kg)
5FW10025	4" (101.6 mm)	1" (25.4 mm)	Stainless Steel	5/16" (7.9 mm)	0.22 lb (0.10 kg)
5FW17550	7" (177.8 mm)	2" (50.8 mm)	Stainless Steel	1/2" (12.7 mm)	1.0 lb (0.5 kg)
7FW27050	11" (279.4 mm)	2" (50.8 mm)	Stainless Steel	1" (25.4 mm)	4.0 lb (1.8 kg)
7FWSS10025	4" (101.6 mm)	1" (25.4 mm)	Stainless Steel	5/16" (7.9 mm)	0.22 lb (0.10 kg)

Star Dropper Hammer



5SDSH

- Used for driving in star (fencing) droppers
- Also used to drive in marker pegs, stakes and concreting stakes
- Heavy unit drives droppers very quickly and efficiently
- Solid steel handles and slug are welded together, which gives greater strength

Cat. No.	Overall Length	Diameter	Weight
5SDSH	33.85" (860 mm)	2-1/8" (54.0 mm)	19.1 lb (8.7 kg)

See page 297 for additional information on warnings.



⚠WARNING: Always wear approved personal protective equipment.

Connecting Bars

Hex and Round Bars

- Provides extra leverage when positioning steel members and aligning bolt holes
- Forged fit-up bar is pointed on one end
- Chisel-end is at a 15° angle to give greater leverage
- Cat. No. 3246TT features tether hole for working at height



Hex Bars				
Cat. No.	Overall Length	Body Diameter	End	Weight
3242	30" (762.0 mm)	3/4" (19.1 mm)	15°	3.5 lb (1.6 kg)
3243	36" (914.4 mm)	7/8" (22.2 mm)	15°	6.0 lb (2.7 kg)
3244	24" (609.6 mm)	3/4" (19.1 mm)	15°	2.5 lb (1.1 kg)
3240	30" (762.0 mm)	3/4" (19.1 mm)	Straight	3.8 lb (1.7 kg)

Round Bars				
Cat. No.	Overall Length	Body Diameter	End	Weight
3245	30" (762.0 mm)	3/4" (19.1 mm)	15°	3.3 lb (1.5 kg)
3246	36" (914.4 mm)	7/8" (22.2 mm)	15°	5.5 lb (2.5 kg)
3246TT	36" (914.4 mm)	7/8" (22.2 mm)	15°	5.3 lb (2.4 kg)
3247	24" (609.6 mm)	3/4" (19.1 mm)	15°	2.5 lb (1.1 kg)
3248	30" (762.0 mm)	7/8" (22.2 mm)	15°	4.3 lb (2.0 kg)
3241	30" (762.0 mm)	3/4" (19.1 mm)	Straight	3.2 lb (1.5 kg)

Connecting Bar Holder with Lock Collar

- Fits Klein® 7/8" (22 mm) connecting bars (Cat. Nos. 3246 and 3248)
- Leather construction
- Tunnel loop allows for weight distribution on belt
- Fits belts up to 3-1/2" (89 mm) wide
- Replacement lock collar (Cat. No. 5459C) available



Cat. No.	Belt Connection	Belt Width	Overall Length	Overall Width	Overall Height	Weight
5459SLVR	Tunnel	Up to 3.5" (88.9 mm)	3" (76.2 mm)	2" (50.8 mm)	6.75" (171.5 mm)	0.40 lb (0.18 kg)

Barrel-Type Drift Pins

- Machined from quality alloy steel
- Tapers are uniform and blend into body diameter
- Tough, drop-forged steel will properly end-pein in use
- Heat-treated for strength
- Black finish for rust resistance



Cat. No.	Overall Length	Diameter	Point Diameter	Weight
3260	7.5" (190.5 mm)	11/16" (17.5 mm)	0.313" (7.9 mm)	0.60 lb (0.27 kg)
3261	8" (203.2 mm)	13/16" (20.6 mm)	7/16" (11.1 mm)	0.85 lb (0.39 kg)
3262	8" (203.2 mm)	15/16" (23.8 mm)	0.500" (12.70 mm)	1.1 lb (0.5 kg)
3263	8" (203.2 mm)	1-1/16" (27.0 mm)	9/16" (14.3 mm)	1.5 lb (0.7 kg)

⚠WARNING: Lock collar should ONLY be used on Klein 7/8" connecting bars. Lock collar must be installed on connecting bar before using holder.

See page 297 for additional information on warnings.



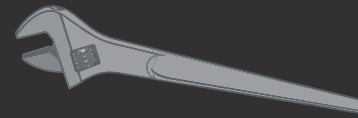

Tool Tethers



Why is it important?

In 2016, the Bureau of Labor Statistics reported there were 255 fatalities and 47,920 reported injuries from dropped objects in the United States, making it the third leading cause of injuries on the jobsite, according to OSHA. Compared to 2015, deaths from dropped objects were up approximately 3.24%, and injuries increased by 6.85%.

Klein Tools' growing line of tethers and tools for Work@Height are designed to protect workers on the jobsite as well as their tools.



Tool Tether

- Keep your tools close at hand when working at height
- Triple-locking carabiner for additional security

Cat. No.	Load Rating	Relaxed Length	Stretched Length	Weight
TT2	15.0 lb (6.8 kg)	32" (81.3 cm)	51" (129.5 cm)	0.10 lb (0.05 kg)



TT2

⚠ WARNINGS:	⚠ WARNINGS:
<ul style="list-style-type: none"> • Inspect for wear before each use. • Do not use for human support. • Never connect over 5 lbs. (2.3 kg) to a person. • Do not use around moving or rotating equipment. 	<ul style="list-style-type: none"> • Tethers extend to anywhere from 3.5' to 5' (1.3 m to 1.5 m). Rig to avoid contact with objects below. • Always ensure cinch remains snug while in use. • Always attach carabiner end to anchor point. • Do not attach tether back onto itself. • Do not tie knots in tether.

Bull Pins

Broad Head Bull Pins



- Forged, heat-treated bull pin increases efficiency by providing a larger striking surface
- Angled head and smooth blending of radii increase strength and reduce the danger of chipping
- Below the head, squared-off shoulders have been forged to provide a surface for applying wrench to loosen wedged bull pins
- Added resistance to "mushrooming" permits much longer use than conventional designs and the even taper reduces binding and hang-up
- Cat. Nos. 3256TT and 3255TT feature tether hole for working at height

Cat. No.	Overall Length	Diameter	Point Diameter	Weight
3255	13.75" (349.3 mm)	1-1/4" (31.8 mm)	0.313" (7.9 mm)	2.9 lb (1.3 kg)
3256	10" (254.0 mm)	1-1/16" (27.0 mm)	1/4" (6.4 mm)	1.6 lb (0.7 kg)

Broad Head Bull Pins with tether hole for working at height

3255TT	13.75" (349.3 mm)	1-1/4" (31.8 mm)	0.313" (7.9 mm)	2.8 lb (1.3 kg)
3256TT	10" (254.0 mm)	1-1/16" (27.0 mm)	1/4" (6.4 mm)	1.5 lb (0.7 kg)

OSHA 1926.301 (c) specifically states: "Impact tools, such as drift pins, wedges and chisels, shall be kept free of mushroomed heads."

Standard Bull Pins

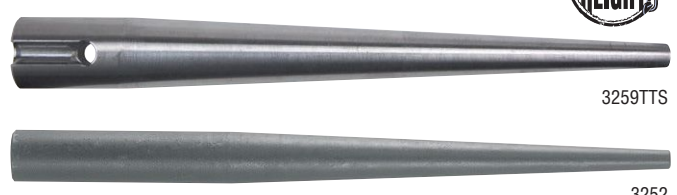

- Machined from quality alloy steel
- Heat-treated for strength, black finish for rust resistance (except Cat. No. 3259TTS)
- Cat. No. 3259TTS has stainless steel finish

Cat. No.	Overall Length	Diameter	Point Diameter	Weight
3251	15" (381.0 mm)	1-1/16" (27.0 mm)	0.375" (9.5 mm)	2.5 lb (1.1 kg)
3252	15" (381.0 mm)	1-3/16" (30.2 mm)	7/16" (11.1 mm)	3.1 lb (1.4 kg)
3257	12" (304.8 mm)	1-1/16" (27.0 mm)	0.375" (9.5 mm)	1.7 lb (0.8 kg)
3258	12" (304.8 mm)	1-3/16" (30.2 mm)	7/16" (11.1 mm)	2.1 lb (1.0 kg)
3259	12" (304.8 mm)	1-5/16" (33.3 mm)	7/16" (11.1 mm)	2.5 lb (1.1 kg)
3265	12" (304.8 mm)	1-1/4" (31.8 mm)	7/16" (11.1 mm)	2.5 lb (1.1 kg)

Standard Bull Pins with tether hole for working at height

3259TT	12" (304.8 mm)	1-5/16" (33.3 mm)	7/16" (11.1 mm)	2.2 lb (1.0 kg)
3259TTS	12" (304.8 mm)	1-5/16" (33.3 mm)	7/16" (11.1 mm)	2.5 lb (1.1 kg)

OSHA 1926.301 (c) specifically states: "Impact tools, such as drift pins, wedges and chisels, shall be kept free of mushroomed heads."



Construction Wrenches

Adjustable-Head Construction Wrenches

- Eliminates the need for carrying several fixed-size wrenches
- Forged from select alloy steel with continuous taper handle for aligning bolt and/or rivet holes
- Industrial black finish for corrosion resistance
- Includes lanyard hole for easy tool tethering
- Precision-machined jaws are individually chosen and assembled by hand for smooth operation
- Heat-treated for long life



3239

Cat. No.	Overall Length	Handle Color	Handle Finish	Jaw Capacity	Weight
3239	16" (406.4 mm)	Black	Black Oxide	1-1/2" (38.1 mm)	2.4 lb (1.1 kg)
3227	11" (279.4 mm)	Black	Black Oxide	1-5/16" (33.3 mm)	1.2 lb (0.5 kg)

1/2" Drive Ratcheting Construction Wrench

- Accepts 1/2" square-drive hex socket
- Reversible ratchet
- Eliminates the need for carrying several fixed-size wrenches
- Forged from select alloy steel with continuous taper handle for aligning bolt and/or rivet holes
- Industrial black finish for corrosion resistance



3238

Cat. No.	Overall Length	Size	Weight
3238	15" (381.0 mm)	1/2"	2.1 lb (1.0 kg)

Erection Wrenches

- Forged from select alloy steel to withstand high-leverage and heavy loads
- Extra-heavy-duty head area gives maximum strength and durability
- Continuous taper of handle makes lining-up bolt holes easy and works on a range of bolt-hole sizes without binding
- Extra-large hub area works on larger diameter holes better than other wrenches
- Catalog number, bolt size and nominal opening size are stamped on every wrench for easy identification
- American Bridge design
- Cat. Nos. 3212TT, 3213TT, and 3214TT feature tether hole for working at height



3231

3214TT

Cat. No.	Overall Length	Nut Type	Bolt Size	Nominal Opening	Head Width	Taper Diameter	Weight
3210	14.75" (374.7 mm)	U.S. Heavy	1/2" (12.7 mm)	7/8" (22.2 mm)	2.25" (57.2 mm)	7/8" to 3/16" (22.2 to 4.8 mm)	1.4 lb (0.6 kg)
3211	14.75" (374.7 mm)	U.S. Heavy	5/8" (15.9 mm)	1-1/16" (27.0 mm)	2.25" (57.2 mm)	7/8" to 3/16" (22.2 to 4.8 mm)	1.3 lb (0.6 kg)
3212	16.625" (422.3 mm)	U.S. Heavy	3/4" (19.1 mm)	1-1/4" (31.8 mm)	2.5" (63.5 mm)	1" to 1/4" (25.4 to 6.4 mm)	2.0 lb (0.9 kg)
3213	17.375" (441.3 mm)	U.S. Heavy	7/8" (22.2 mm)	1-7/16" (36.5 mm)	3" (76.2 mm)	1-1/8" to 9/32" (28.6 to 7.1 mm)	2.7 lb (1.2 kg)
3214	18" (457.2 mm)	U.S. Heavy	1" (25.4 mm)	1-5/8" (41.3 mm)	3.625" (92.1 mm)	1-1/8" to 1/4" (28.6 to 6.4 mm)	3.4 lb (1.5 kg)
3219	14.75" (374.7 mm)	U.S. Regular	1/2" (12.7 mm)	3/4" (19.1 mm)	2.25" (57.2 mm)	7/8" x 1/2" (22.2 to 12.7 mm)	1.4 lb (0.6 kg)
3220	14.75" (374.7 mm)	U.S. Regular	1/2" (12.7 mm)	13/16" (20.6 mm)	2.25" (57.2 mm)	7/8" to 3/16" (22.2 to 4.8 mm)	1.4 lb (0.6 kg)
3221	14.75" (374.7 mm)	U.S. Regular	5/8" (15.9 mm)	1" (25.4 mm)	2.25" (57.2 mm)	7/8" to 3/16" (22.2 to 4.8 mm)	1.3 lb (0.6 kg)
3222	16.625" (422.3 mm)	U.S. Regular	3/4" (19.1 mm)	1-1/8" (28.6 mm)	2.5" (63.5 mm)	1" to 1/4" (25.4 to 6.4 mm)	2.0 lb (0.9 kg)
3223	17.375" (441.3 mm)	U.S. Regular	7/8" (22.2 mm)	1-5/16" (33.3 mm)	3" (76.2 mm)	1-1/8" to 9/32" (28.6 to 7.1 mm)	2.9 lb (1.3 kg)
3224	18" (457.2 mm)	U.S. Regular	1" (25.4 mm)	1-1/2" (38.1 mm)	3.625" (92.1 mm)	1-1/8" to 1/4" (28.6 to 6.4 mm)	3.4 lb (1.5 kg)
3231	14.75" (374.7 mm)	Utility	5/8" (15.9 mm)	15/16" (23.8 mm)	2.25" (57.2 mm)	7/8" to 3/16" (22.2 to 4.8 mm)	1.3 lb (0.6 kg)
3232	16.625" (422.3 mm)	Utility	3/4" (19.1 mm)	1-1/16" (27.0 mm)	2.5" (63.5 mm)	1" to 1/4" (25.4 to 6.4 mm)	2.0 lb (0.9 kg)

Erection wrenches with tether hole for working at height

3212TT	16.625" (422.3 mm)	U.S. Heavy	3/4" (19.1 mm)	1-1/4" (31.8 mm)	2.5" (63.5 mm)	1" to 1/4" (25.4 to 6.4 mm)	2.0 lb (0.9 kg)
3213TT	17.375" (441.3 mm)	U.S. Heavy	7/8" (22.2 mm)	1-7/16" (36.5 mm)	3" (76.2 mm)	1-1/8" to 9/32" (28.6 to 7.1 mm)	2.7 lb (1.2 kg)
3214TT	18" (457.2 mm)	U.S. Heavy	1" (25.4 mm)	1-5/8" (41.3 mm)	3.625" (92.1 mm)	1-1/8" to 1/4" (28.6 to 6.4 mm)	3.4 lb (1.5 kg)



Warning Symbols



Safety alert symbol: Indicates a hazard.



Do NOT use to pry.



It is important that users of these products read, understand, and follow all instructions, cautions, and warnings that are attached to and/or packed with the product.



Always ensure that you and the persons in the vicinity wear approved eye protection.



Do NOT use to chisel.



Strong magnetic field.



NOT insulated. Plastic-dipped or slip-on plastic handles are NOT intended for protection against electrical shock.



Do NOT extend handle length.



Wear approved hand protection.

Never use on or near live electrical circuits.



Do NOT use to push or hammer.



Use a safe work position to avoid loss of balance.

WARNING: Cancer and reproductive harm – See www.P65Warnings.ca.gov for more information.

Test and Measurement

⚠️ WARNINGS:

- To ensure safe operation and service of the tester, follow these instructions. Failure to observe these warnings can result in severe injury or death.
- Before each use, verify meter operation by measuring a known voltage or current.
- Never use a meter on a circuit with voltages that exceed the category based rating of the meter.
- Do not use the meter during electrical storms or in wet weather.
- Do not use the meter or test leads if they appear to be damaged.
- Ensure meter leads are fully seated, and keep fingers away from the metal probe contacts when making measurements.
- Never assume neutral or ground wires are de-energized. Neutrals in multi-wire branch circuits may be energized when disconnected and must be retested before handling.
- Do not open the meter to replace batteries while the probes are connected.
- Use caution when working with voltages above 60V DC, or 25V AC RMS. Such voltages pose a shock hazard.
- To avoid false readings that can lead to electrical shock, replace batteries if a low battery indicator appears.
- Unless measuring voltage or current, shut off and lock out power before measuring resistance or capacitance.
- Always adhere to local and national safety codes. Use individual protective equipment to prevent shock and arc blast injury where hazardous live conductors are exposed.

Non-Contact Voltage Tester (Additional Warnings)

⚠️ WARNINGS:

- Use caution with voltages above 30V AC as a shock hazard may exist.
- A single blinking LED or a steady glowing LED and an audible beep indicate voltage present. If no indication, voltage could still be present.
- Before and after each use, verify operation by testing a known working circuit that is within the rating of this unit.
- The tester **WILL NOT** detect voltage if:
 - The wire is shielded.
 - The operator is not grounded or is otherwise isolated from an effective earth ground.
 - The voltage is DC.
- The tester **MAY NOT** detect voltage if:
 - The user is not holding the tester.
 - The user is insulated from the tester with a glove or other materials.
 - The wire is partially buried or in a grounded metal conduit.
 - The tester is at a distance from the voltage source.
 - The field created by the voltage source is being blocked, dampened, or otherwise interfered with.
 - The frequency of the voltage is not a perfect sine wave between 50 and 500Hz.
 - The tester is outside of operation conditions (listed in Specifications section).
- Operation may be affected by differences in socket design and insulation thickness and type.
- In bright light conditions, the LED visual indicators will be less visible.
- Do not use if power on LED is not illuminated.
- Do not use if tester appears damaged or is not operating properly. If in doubt, replace the tester.
- Do not apply more than the rated voltage as marked on the tester (1000V).
- Detection above 12V is specified under normal conditions as specified below. The tester may detect at a different threshold at different conditions, or may not detect at all unless:
 - The tip of the tester is within 0.25 of an AC voltage source radiating unimpeded.
 - The user is holding the body of the tester with his or her bare hand.
 - The user is standing on or connected to earth ground.
 - The air humidity is nominal (50% relative humidity – non-condensing).
 - The tester is held still.
- Always wear approved eye protection.
- Comply with local and national safety requirements.
- If this product is used in a manner not specified by the manufacturer, protection provided by the product may be affected.
- Do not attempt to repair this tester. It contains no serviceable parts.
- Do not expose the product to extremes in temperature or high humidity.

Insulated Tools



⚠️ WARNING: Only use tools that are marked with the official international 1000-volt rating symbol shown below, if there is any chance that the tools will make contact with an energized source.

⚠️ WARNING: Wear approved eye protection. Always inspect your tools before use. Do not use if orange coating cracks, breaks or becomes damaged. Destroy tool if white layer shows through orange layer.

⚠️ WARNING: Do NOT touch uninsulated portion of the tool or any conductive object when either might contact an energized source.

⚠️ WARNING: Whenever possible, always de-energize lines and equipment prior to working on or around them. Klein insulated tools are designed only to reduce the chance of injury where the tool may make contact with an energized source.

⚠️ WARNING: Because moisture, films, or other surface contaminants are conductive, Klein insulated tools must be kept clean, dry, and free of any surface contaminants.

Infrared Thermometer

⚠️ CAUTION: Reflective materials may be hotter than indicated. Laser radiation-do NOT stare into beam. Class 2 laser product.

Wire Pulling Grips

⚠️ WARNING: Grips are to be used for temporary installation, not for permanent anchorage.

⚠️ WARNING: When used on/or near energized lines, ground, insulate, or isolate grip before pulling.

⚠️ WARNING: Do not exceed rated capacity.

⚠️ WARNING: Always match proper size and type of grip to application.

⚠️ WARNING: Before each use, clean jaw area and inspect grip for proper operation to avoid slippage.

Item	Page	Item	Page	Item	Page
A					
Aerial Aprons	254	Coaxial	31	Conduit Locknut Wrench	113
Aerial Buckets	252	Gear-Driven	282	Pliers, Locknut/Reaming	114
Hooks	254	Heavy-Duty	32	Reamer	114
Aviation Snips	217	High-Leverage	31	Scoring Tool	113
B					
Backpacks	151-153	Journeyman Handles	31	Screwdriver, Fitting/Reaming	114
Bags		Multi-Cable	32	Connectors	
Canvas	157-158	Ratcheting	34	Coaxial	175
Fish Rod	108	Ratcheting, Heavy-Duty	35	IDC	177
Lineman	250-253	Rope	33	Pass-Thru™	178
Tool	151-164	Utility Cable	33	Twisted Pair	178
Vinyl	159	Cable Cutting Knives	243-245	Construction Tools	292-293
Zipper	151-155, 161-163	Cable Preparation	173	Drift Pins	294
Bars		Cable Ripper	27	Fox Wedges	293
Connecting	294	Cable-Sheath Splitting Knives	244	Grizzly Bar	293
Grizzly™	293	Cable Skinning Knives	243-244	Hex and Round Bars	294
Battery-Operated Tools	281	Cable-Splicing Knives	245	Rebar Hickeys	292
Combination Cutter/Crimpers	283-284	Cable Strippers	24, 173	Tie-Wire Reel	292
Crimpers	283-284	Cable Testing	183-188	Wrenches	296
Gear-Driven Cable Cutters	282	Accessories	188	Continuity Tester	183, 200
Impact Wrench	282	Canvas Bags	157-158	Coolers	127-128
Belt		Canvas Buckets	251	Crimper, Compression	174
Tie-Wire	292	Can Wrench	85, 178	Crimper, Ratcheting	175, 176-177
Belts	147-149, 292	Carbide Hole Cutters	226	Crimper, Sheet Metal	218
Bent Trimmers	248	Carbon Monoxide Meter	205	Crimping Tools	25, 28-29, 174-177
Blocks	257-259	Carrying Cases	144, 209-210	7-Ton	283-284
Bolt Bags	136	Caution Tape	120	12-Ton	283
Bolt Cutters	36	Chicago Grips	270-274	Coaxial	174-175
Borescopes	208-209	Chisels	289	Compound-Action	29
Accessories	209	Circuit Breaker Finder	203	Multi-Purpose	25, 28
Brass Punches	290	Accessory Kit	203	Pliers	9, 11, 16, 19, 177
Buckets		Clamp Meters	194-196	Ratcheting	29
Canvas	251	Accessories	199-200	Twisted Pair	176-177
Load Rated	250	Kit	198	Cushion-Grip Nut Drivers	65-67
Oval	252	Line Splitter	200	Cushion-Grip Screwdrivers	50-59
Tapered-Wall	251	Coax Explorer Testers	183	D	
Vinyl Top	251	Coaxial Connectors	175	Diagonal-Cutting Pliers	12-15
Bull-Pin Bags	136	Coaxial Testing	183-188	Distance Measuring	101
Bull Pins	295	Coaxial Tools	173-175	Drift Pins	294
BX/Armored Cable Cutter	112	Installation Kits	180-181	Drift Punches	290
C					
Cable Benders	35	Combustible Gas Leak Detector	205	Drywall Saws	235
Cable Connection	174-178	Compass Saw	234	Drill Bits	230-231
Cable Cutters	31-35, 283-284	Blades	234	Sets	230-231
7-Ton	283-284	Compression Crimpers	174	Drill/Tap/Deburr Set	73
BX Cable	32	Conduit Benders	111-112	Duct Cutter	219
		Aluminum	111	Duct Knife	245
		Handles	112	Duct Knife, Serrated	220
		Iron	112	Duct Stretcher	220
		Conduit Reamers	71, 114	Duct Tools	219-220
		Conduit Tools	111-114	Hole Cutter	220
		Benders	111-112		
		BX/Armored Cable Cutter	112		

Item	Page	Item	Page	Item	Page
Wire Strippers	24-25	Folding Rulers	102	End-Cutting	20
Knee Pads	118	Laser	101	Handles	22
Knife Sharpening	246	Tapes	100-102	Ironworker's	10, 13
Knives	237-246	Meter Accessories	199	Lineman's	8
Cable-Sheath Splitting	244	Mobile Phone Holders	129, 144	Long-Nose	16-20
Cable Skinning	243-244	Modular Crimpers	176-177	Multifunction	11
Cable-Splicing	245	Multi-Bit Screwdrivers/Nut Drivers	55-60	Plastic-Cutting	15
Multi-Tools	241	Multifunction Pliers	11	Pump	21
Pocket	237-240	Multimeters	197-198	Side-Cutting	8-11
Pocket, Multi-Blade	240	Accessories	199-200	Slip-Joint	22
Serrated Duct Knife	245	Fuses	198	Specialty	20
Sharpening Tools	246	Kit	198	Telecom	19-20
Utility	241-243	Multi-Nut Drivers	67	Pocket Knives	237-240
Utility, Blades	243	Multi-Tools	241	Multi-Blade	240
Knockout Punches	227			Multi-Tools	241
				Pole Pick	254
L		N		Pole Sling	254
LAN Scout Jr Tester	183	Non-Contact Voltage Testers (NCVT)	202	Power Driver Bits	72-73, 223
Laser Measuring	101	Notcher	218	PowerLine Series	145-147
Leather Tool Pouches	131-134, 137-140	Nut Drivers	64-69	Combo Sets	147
Levels	98-100	Coated	67	Suspenders	146
Accu-Bend	99	Cushion-Grip	65-67	Tool Belts	147
Conduit Bending	99	Full-Hollow Shaft	64	Tool Holders	146
Laser	98	Hollow-Shaft	65-69	Tool Pouches	145-146
Torpedo	99	Insulated	44	Power Tools	281
Light Meter	204	Magnetic	65, 69	Crimpers	283
Line-Hose Bag	253	Metric	66, 69	Gear-Driven Cable Cutters	282
Lineman		Multi-Nut	67	Impact Wrench	282
Aerial Aprons	254	Plastic-Handle	68-69	Personal Protection Equipment (PPE)	116-125
Bags	159-160			Caution Tape	120
Buckets, Canvas	251	O		Eyewear	117
Buckets, Load Rated	250-252	Oval Buckets	252	Gloves	121-125
Buckets, Oval	252			Hard Hats	118
Buckets, Tapered-Wall	251	P		Knee Pads	118
Cable Skinning Knives	243-245	Parallel Jaw Grips	275-276	Lockouts	120
Electrode Bags	253	Pass-Thru™ Connectors	178	Shoe Covers	118
Gloves	125	Pass-Thru™ Crimpers	176	Probe Plus	189
Hammers	286	Penlight	213	Probe Thermometers	206
Line-Hose Bag	253	Phone Holder	129, 144	Pump Pliers	21
Wrenches	85-86	Pin Punches	290	Punchdown Tools	190-192
Lineman's Pliers	8-10	Pipe & Tubing Tools	220-221	Accessories	192
Line Splitter	200	Swaging Punch	221	Punches	289-290
Load Rated Buckets	250	Tube Bender	221	Brass	290
Lockouts	120	Tube Cutters	220	Center	290
Long-Nose Pliers	16-20	Plastic-Cutting Pliers	15	Drift	290
		Pliers	5-22	Pin	290
M		Combination	11	Wire Rope	289
Magnetic Wristband	129	Conduit	20, 114	Punch, Sheet Metal	218
Magnetizer / Demagnetizer	129	Diagonal-Cutting	12-15	PVC Cutters	115
Measuring	100-102	Electronics	14-15, 18		

Item	Page	Item	Page	Item	Page
R					
Radial Strippers	173	Color-Coded	50	T	
Cartridges	173	Conduit	71	Tackle	253-259
Rebar Hickeys	292	Cushion-Grip	50-58	Tape Measures	100-101
Receptacle Testers	203	Demolition	52	Fiberglass	102
Reciprocating Saw Blades	234	Electronics	52, 56	Holders	101
Refrigeration Wrenches	84, 222	Extended-Reach	58	Tape Thong	140
Remote Kits	188	Folding	59, 223	Tapered-Wall Buckets	251
Replacement Parts		HVAC	223	Tapping Tools	70
7-Ton Cable Cutter/Crimper	284	Impact-Driver	63	Telecom Pliers	19-20
BX/Armored Cable Cutter	112	Insulated	42-43	Testers	
Cable Skinning Knives	243	Magnetizer/Demagnetizer	129	VDV Cable	183-187
Conduit Reamers	71, 114	Miniature	50	Electrical	194-203
Continuity Tester	200	Multi-Bit	55-60, 223	High-Voltage	211
Fish Tapes	106	Multi-Bit Replacement Bits	60	Test Leads	199
Gear-Driven Cable Cutters	282	Plastic-Handle	61-62	Test-n-Map Remotes	188
Hole Cutter	220	Rapi-Drive	52-53	Tether	295
Hole Saws	225	Ratcheting	57	Thermocouples	199
Multimeter Fuses	198	Screw-Holding	54, 62-63	Thermometers	206-207
PVC Cutters	115	Sets	53	Infrared	206-207
Scoring Tool	113	Slide Drive	54, 56, 223	Pocket	206
Screwdriver Bits	59, 60	Stubby	58	Probe	206
Tapping Bits	70	Terminal Block	54	Tie Tensioning Tools	221
Tin Snips	218	Torque	63	Tie-Wire Reel	292
Wire Pulling Grip	272	Wire Bending	55	Tin Snips	218
Rope	256	Seamers	219	Tire Levers	289
Round Bars	294	Sheet Metal Tools	217-219	Tone Generator	189
S					
Safety Glasses	117	Crimper	218	Tone & Probe	189-190
Saws and Saw Blades	233-235	Folding	219	Tool Apron	137
Compass Saws	234	Notcher	218	Tradesman Pro	141-142
Hacksaw Blades	233	Punch	218	Tool Bag	
Hacksaws	233	Seamers	219	Shoulder Straps	164
Jab Saws	235	Snips	217	Tool Bags	153-155, 157-161
Reciprocating Saw Blades	234	Tin Snips	218	Ballistic Nylon	157
Scissors	246-248	Ship-Auger Bits	229	Bucket Bag	156
Bent Trimmers	248	Shoe Covers	118	Canvas	157-158
Electrician	246	Shoulder Straps	164	Drawstring	160
High-Leverage Snip	247	Side-Cutting Pliers	8-10	Leather	161
Snips	247-248	Sledge Hammers	288	Tradesman Pro	151-156
Scotchlok (IDC)	177	Slide Racks	165	Vinyl	159-160
Scout Pro™ Cable Testers	186-187	Slip-Joint Pliers	22	Tool Belt Pads	149
Remotes	188	Snap Loop	140	Tool Belts	148-149
Scratch Awls	71	Snips	217, 247-248	Belt Pads	149
Screwdriver		Speaker	128	PowerLine Series	147
Conduit	114	Star Dropper Hammer	293	Tradesman Pro	143
Screwdrivers	50-63	Steel Strand Grips	274	Tool Boxes	165-166
Adjustable-Length	53	Step Drill Bits	229	Tool Guards	140
Coated	52	Suspenders	149	Axe	140
		PowerLine Series	146	Splitting-Knife	140
		Tradesman Pro	143	Tool Holders	138-140
		Swaging Punch	221	Bull-Pins	139
				Connecting Bar	140

Item	Page	Item	Page	Item	Page
Electrical Tape	140	Tradesman Pro	141-144, 151-156	Poly Line	110
Erection Wrenches	139	Backpacks	151	Telescopic Pole	109
Flashlight	138, 146	Cases	144, 210	Wax	110
Folding Rulers	138	Coolers	127-128	Wire Pulling Grips	260-276
Hacksaw	156	Phone Holder	129, 144	Care and Maintenance	261
Hammers	139, 146	Suspenders	143	Chicago	270-274
Knives	138, 143, 146	Tool Apron	142	Cleaning Brush Set	276
Meters	143	Tool Bags	153-155	Parallel Jaw	275-276
Meters/Testers	144	Tool Belt	143	Steel Strand (Havens)	274
Mobile Phone	129, 144	Tool Holder	143-144, 156	Wire Mesh	280
Pliers	138	Tool Pouches	141-142, 156	Wire Rope Punches	289
PowerLine Series	146	Totes	155	Wire Strippers	24-28
Scissors	138	Zipper Bags	161	Adjustable	26-27
Screwdrivers	138	Tube Bender	221	Dual-Wire	26
Snap Loop	140	Tube Cutters	220-221	Forged, Heavy-Duty	24
Tape Measures	101, 139, 146	PVC	220	Katapult	27
Tie-Wire Reel	140	Steel and Copper	221	Klein-Kurve	25
Wrenches	138	Twisted Pair Connectors	178	Multi-Purpose	24-25, 28
Tool Kits	167-171	Twisted Pair Testing	183-188	Romex	25, 27
Block and Tackle	258-259	Twisted Pair Tools	176-177	Self-Adjusting	27
Cable-Splicing	245	Installation Kits	181-182	with Crimping	25
Coaxial	180			Work at Height Tools	295-296
Flexible Bits	228	U		Worklights	213, 215
Hole Cutter	226-227	UG Connectors	177	Wrenches	74-88, 222
Hole Saws	226	UR Connectors	177	Adjustable	75-76, 222
Insulated	45-47	USB Meters	204	Can	85, 178
Meters	198	Utility Knives	241-243	Combination	76-78
Twisted Pair	181	Blades	243	Conduit Locknut	85
Voice/Data/Video	179-182	UY Connectors	177	Construction	87, 296
Tool Pouches	131-136			Erection	87, 296
Ballistic Nylon	133	V		Impact Sockets	86
Bolt Bags	136	VDV Commander	185	Lineman's	85-86
Bull-Pin Bags	136	Remote Kit	188	Metric, Combination	78
Canvas	132, 134-136	VDV ProTech Kits	179	Metric, Sockets	80
Flame-Resistant	135-136	VDV Ranger	184	Open-End	79
Leather	131-134, 136	VDV Scout Pro™ Testers	186-187	Ratcheting Box	83-85
Mobile Phone	129	Vinyl Bags	159-160	Refrigeration	84, 222
PowerLine Series	145-146	Voltage Testers	200-201	SAE	76-77, 79
Tradesman Pro	141, 156	Non-Contact	202	Sets	77-79, 81-82, 83-84
Tool Sets				Socket	80-82
Drill Bits	230-231	W		Strap	88
Hex-Keys	90-94, 96	Wall Anchors	230	Torque	88
Insulated	43-44	Wedges	293		
Knockout Punch	227	Wire Identification	111	Z	
Nut Drivers	64-66, 68-69	Wire Mesh Grips	280	Zipper Bags	161-163
Screwdrivers	50-53, 59, 61-62	Wire Pulling	103-111	Ballistic Nylon	161-163
Socket Wrenches	81-82	Conduit Tools	112	Canvas	162-163
Tool Belts	141, 147	Fish/Glow Rods	107-108	Leather	162-163
Wrenches	77-79, 83-84	Fish Tapes	104	Tradesman Pro	161
Tool Tether	295	Lubricant	109-110		
Tool Totes	155, 160	Magnetic	109		
Tracing Probe	189				

Item	Page	Item	Page	Item	Page
1		13105	60	1628-17	272
1000	28	13231	60	1628-18	272
1001	28	13391	60	162830N	271
1003	26	13392	60	1628-30N	264, 268
1004	26	1515-1	244	1628300	271
1005	29, 169	1515-S	244	1628-300	264-265, 268
1005-INS	41, 46	1550-11	239	162830P	271
1006	29	1550-2	240	1628-30P	265, 269
1009	25	1550-24	239	162830R	271
1010	28	1550-4	239	1628-30R	265, 269
1011	26	1550-44	239	162830S	271
1011M	26	1550-6	240	1628-30S	265, 269
1016	241	1570-3	244	162830T	271
1019	25	1570-3LR	244	1628-30T	265, 269
1104	32	1571INS	41, 45-46	162830U	271
11045	26, 169-171	1580-3	244	1628-30U	265, 269
11045-INS	41, 46-47	1604-10	274	162830VRP	272
11046	26	1604-20	274	162840A	271
11047	26	1604-20L	274	1628-40A	265, 269
11048	26	1611-20	273	162840U	271
11049	26	1611-30	273	1628-40U	265, 269
11049-INS	41	1611-40	273	162840VRU	272
11053	25	1611-50	273	162840W	271
11054	25	1613-30	273	1628-40W	265, 269
11054EINS	41	1613-35	273	162840X	271
11054GLW	25	161335H	273	1628-40X	265, 269
11055	25, 168, 170-171	1613-40	272	162840Y	271
11055-INS	41, 47	1613-40H	272	1628-40Y	265, 269
11057	25	1625-20	274	162840Z	271
11061	27	162520-1	274	1628-40Z	265, 269
11063W	27	162520-114	274	162850A	271
11073	27	162520-7/8	274	1628-50A	265-267, 269
11074	27	1628-16	272	162850B	271
11081	27	1628-16AT	274	1628-50B	265-267, 269
11082	27	162816PE	270	162850C	271
1200BI	233	162816PF	270	1628-50C	265, 266
1200BI-P	233	162816PG	270	162850D	271
1200L	217-223	1628-16PG	264	1628-50D	265-267, 269
1201R	217-223	162816PH	270	162850E	271
1202S	217-223	1628-16PH	264	1628-50E	265-266, 269
12098	11	162816PI	270	162850F	271
12098EINS	40	1628-16PI	264, 268	1628-50F	265, 266
12098-INS	40, 46	162816PJ	270	1628-50P	265-267, 269, 271
1218BI	233	1628-16PJ	264, 268	1628-50R	265-267, 269, 271
1218BI-P	233	1628-16PK	264, 268, 270	162850S	271
1224BI	233	162816PL	270	1628-50S	265-267, 269
1224BI-P	233	1628-16PL	264, 268	162850T	271
1232BI	233	162816PL	264, 268	1628-50T	265-267, 269
1232BI-P	233	162816PM	270	162850U	271
13104	60	1628-16PM	264, 268	1628-50U	265-267, 269
		162816PN	270	162850W	271
		1628-16PN	264, 268		

Item	Page	Item	Page	Item	Page		
1628-50W	265, 266, 267, 269	19352	71, 114	3	3146	85	
162850X	271	19353	71, 114		3146A	85	
1628-50X	265, 266, 267, 269	19542	50		3146B	85	
162850Y	271	19543	50		31716	234	
1628-50Y	265, 266, 267, 269	19544	50		31727	234	
162850Z	271	19545	50		31728	234	
1628-50Z	265, 266, 269	19546	50		31731	234	
1656-20	264, 268, 270	19555	50		31734	234	
1656-20H	264, 268, 270	2			31737	235	
1656-30	264, 268, 270		200028EINS		39	31739	234
1656-30H	264, 268, 270		200048EINS		39	31741	234
1656-40	264, 268, 270		20009NEEINS		39	31751	234
1656-40H	264, 268, 270		2006		29	31755	234
1656-50	264, 270		2012		254, 256	31761	234
1656-50H	264, 270		201-7CST		10	31850	226
1656-60	264, 270		2036EINS		40	31852	226-227
1656-60H	264, 270		2037EINS		40	31856	226-227
1659-20	273		2038EINS		40	31860	226-227
1659-30	273		2100-5		246	31866	226-227
1659-40	273		2100-7		245, 246	31868	226-227
1659-50	273		2100-8		179, 182, 190, 246	31870	226-227
1659-5AT	274		2100-9		246	31872	226
1671-10	272		21010		245	31873	227
1672-10	272		21050		24	31874	226-227
1675-20	276		21051		24	31900	225
1675-21	276		2138NEEINS		39	31902	226
1684-5	272		213-9NE		8	31905	225-226
1684-5AT	274		2139NEEINS		39	31906	225-226
16845C	272		213-9ST		10	31907	225-226
16845CAT	274		22000		247	31914	225-226
1684-5F	272		22001	247	31918	225-226	
1684-5H	272		22002	247	31922	225-226	
1684-74	272		22003	247	31928	225-226	
1684-74H	272		23008	248	31932	225-226	
1685-20	276	23010	248	31940	225-226		
1685-31	276	23011	248	31944	225		
1686-10	272	23015	248	31948	225		
1686-20	272	24000	248	31958	225		
1692-5	272	24001	248	31972	225		
1692-5AT	274	25450	276	32008	52		
1702-20HH	257	258	256	3210	87, 296		
1702-20N	257	259	256	3211	87, 296		
1716-60	275	26001	247	3212	87, 296		
1716-70	275	267	257	3212TT	87, 296		
1716-71	275	268	257	3213	87, 296		
1802-30	258	27400	140, 292	3213TT	87, 296		
1802-30S	258	27450	140, 292	3214	87, 296		
1802-30SR	258			3214TT	87, 296		
1802-30SSR	258			3219	87, 296		
1803-60	256						
1804-60	256						

Item	Page	Item	Page	Item	Page
3220	87, 296	32482	60	32593	57
3221	87, 296	32483	60	32594	57
32215	54	32484	60	32596	56, 223
32216	54	32485	60	3259TT	295
32217	73	32500	58	3259TTS	295
3222	87, 296	32505	55	3260	294
3223	87, 296	3251	295	3261	294
32234	72	32510	59	32618	53
32235	72	32517	70	32619	53
32237	73	32518	70	3262	294
32238	73	3252	295	3263	294
32239	73	32525	59	3265	295
3224	87, 296	32526	59	32708	53
32240	73	32527	56, 223	32709	53
32241	73	32528	60	32713	53
32242	73	32534	59, 223	32715	53
3227	87, 296	32535	59	32751	53
32290	55	32536	59	32752	60
32291	55	32537	59	32759	72
32292	55	32538	59	32770	60
3231	87, 296	32539	59	32771	60
3232	87, 296	32540	60	32772	60
32378	51	32541	60	32773	60
3238	87, 296	32542	60	32774	60
3239	87, 139, 296	32543	60	32775	60
32392	60	32544	60	32776	60
32394	60	32545	60	32777	60
32395	60	32546	60	32778	60
32396	60	32547	60	32779	60
32397	60	32548	60	32780	60
32398	60	32549	60	32781	60
32399	60	3255	295	32782	60
3240	294	3255TT	295	32783	60
32400	60	32550	60	32784	60
32401	60	32551	60	32800	67
3241	294	32552	60	32801	67
32410	60	32553	60	32807MAG	67
32411	60	32554	60	32905	226
32412	60	32557	57	33524	44
3242	294	32558	57	33525	45
3243	294	32559	58	33525SC	45
3244	294	32560	58	33526	47
3245	294	32561	58	33527	46
3246	140, 294	32562	58	33528	43
3246TT	294	3256	295	33529	47
32476	58	3256TT	295	33532-INS	43
3247	294	3257	295	33534	44
32477	58	3258	295	33535	45
32478	60	32581	56	33535SC	45
32479	60	32585	56	33536	47
3248	140, 294	3259	295	33537	46

Item	Page	Item	Page	Item	Page
33538	43	40233	121	45200	120
		40234	121	45201	120
		42200	137	455	256
4		42201	137	46037	168, 245
40002	125	42241	133	46039	245
40003	124	42242	137	470	256
40004	124	42244	137	48036	246
40006	124	42245	133, 137	48502	256
40007	124	42246	133, 137	4BP10	290
40008	124	42247	134	4BP16	290
40010	124	44000	238	4BP19	290
40012	124	44000-BLK	238	4BP25	290
40014	124	44001	238	4BPSET5	290
40015	124	44001-BLK	238	4PPL02.5	290
40016	124	44002	238	4PPL03	290
40017	124	44003	238	4PPL04	290
40018	124	44004	238	4PPL05	290
40021	124	44005	238	4PPL06	290
40022	124	44005C	238	4PPL06.5	290
40023	124	44005R	238	4PPL08	290
40072	125	44005RC	238	4PPL10	290
40074	125	44006	238	4PPLSET8	290
40080	125	44007	238		
40082	125	44032	239	5	
40084	125	44033	239	500-18	75
40086	125	44034	239	500-24	75
40205	122	44036	240	50031	115
40206	122	44037	240	5003-18	158, 168
40207	122	44052BLK	238	5003-20	158
40208	122	44100	169, 243	50033	115
40209	122	44101	243	50034	115
40210	122	44103	243	50035	115
40211	122	44130	242	502-10-EINS	40
40212	122	44131	242	50350	106
40213	122	44133	168, 242	50351	106
40214	123	44135	241	50400	35
40215	123	44136	242	50402	35
40216	123	44138	243	50506SEN	115
40217	123	44142	239	50549	115
40218	123	44151	246	506-10	169
40219	123	44200	245	506-15	75
40220	123	44201	237	507-10	75
40221	123	44213	237	507-12	75
40222	123	44216	241	507-6	75
40226	121	44217	237	507-8	75
40227	121	44218	243	5100M	138
40228	121	44219	243	5101	138
40229	121	44220	237	51010	110
40230	121	44222	237	51012	110
40231	121	44223	237	51013	110
40232	121	443A	256		

Item	Page	Item	Page	Item	Page
51015	110	5118P5	132	5162T	131
51017	110	5118PRS	138	5163	138
51018	110	5118R	138	5164	131, 170
5102-12	157	5118RT	138	5164T	131
5102-14	157	5118S	138	5165	131, 170
5102-14SP	157	5119	132, 171	5166	131, 171
5102-16	157, 169	5121-15	164	5167	131
5102-16SP	157	5121-19	164	5171PS	251
5102-18	157	5122-16	164	5172PS	251
5102-18SP	157	5122-18	164	5178	131
5102-20	157	5124-15	164	5179	135
5102-22	157	5124-17	164	5179S	135
5102-24	157	5124-19	164	5180	159
5102-24SP	157	5125	132	5181ORA	159
51028	109	5125L	132	51828	254
5102S	157-158, 164	5126	132	51829	254
5103S	251	5127	132	51829M	254
5104	250	5127T	132	51829MHS	254
5104CLR17	250	5129	138	5182BLA	159
5104CLR22	250	5130	140	5183	142
5104CLRFR	250	5136	162	5184	143, 210
5104FR	250	5139	163, 168-169	5185	138
5104OCTO	250	5139B	163	5185ORA	160
5104S	250	5139C	163	5187	138, 245
5104VT	251	5139L	163	5187T	138
5105-20	158	5139PAD	163	5188	138
5105-24	158	5140	163	5188T	138
5106	251	5140K	134	5189	143, 210
5106P	251	5141	163	5190	131
5106S	251	5141P	135	5194	139
5107-6	138	5142	135	5195	101, 137, 139
5107-9	138	51425	120	5195TT	101
5108-18	161	51427	112	5196	101, 139
5108-20	161	51428	112	51A	134
5108-24	161	51429	112	51TOP	251
5109	250	5142P	135	5200-15	157
5109CSV	250	5143	253	5201	148
5109P	250	5144	252	5202L	148
5109PS	250	5144B	252	5202M	148
5109S	250	5144BHB	252	5202XL	148
5109SLR	250	5144BHB140S	252	5204	148, 171
5109SV	250	5144BHHB	252	5216V	159
51100	109	5144H	254	5225	137, 148, 170-171
5110-48	253	5144HBS	252	5236	162
5111	133	5144S	252	5240	142
5112	138	5145	132	5241	142
5113	251	5146	134	5242	141
5113S	251	5151	160	5243	141
5115	161	5152S	252	5244	142
5118C	138	5155	158	5245	143
5118P4	132	5156	158	5246	143

Item	Page	Item	Page	Item	Page
5247	143	53723	228	54439	166
5248	143	53725	112	54440	166
5300	171	53726-SEN	112	54445	166
53000	230	53727SEN	227	54446	166
53001	231	53728SEN	227	54447	166
53002	231	53729	230	54448	166
53100	230-231	53731	225	54451	165
53101	230-231	53732SEN	227	54474	165-166
53102	230-231	53751	228	54476	165-166
53103	230-231	53819	227	54477	165-166
53104	230-231	53820	227	54484	165
53105	230-231	53827	227	54486	165
53106	230-231	53828	227	5456	139
53107	230-231	53837	227	5456T	139
53108	230-231	53838	227	5456TS	139
53109	230-231	53849	227	5458	140
53110	230-231	53850	227	5459C	140, 294
53111	230-231	53857	227	5459SLVR	140, 294
53112	230-231	53858	227	5459T	139
53113	230	53867	227	5460	139
53114	230-231	53868	227	5461T	139
53116	230-231	53871	227	5471	135, 253
53117	230	53872	227	5471FR	135, 253
53118	230-231	53873	227	5481	133
53119	230	5415	148	5482	133
53120	230-231	5415L	148	5509	140
53121	230	5415S	148	5539BLU	162
53122	230-231	5415XL	148	5539CPAK	162
53123	230	5416	136	5539NAT	162
53124	230-231	5416L	136	5539RED	162
53125	230	5416OCTO	136	5539YEL	162
53126	230-231	5416T	136	55400	143
53127	230	5416TBR	136	554158-14	155
53128	230-231	5416TC	136	5541610-14	155
5336	162	5416TCP	136	55419SP-14	156
53402	229	5416TFR	136	55421BP-14	152
53404	229	5416TSR	136	55421BP14CAMO	152
53406	229	5417	139	55427	141
53408	229	5417T	139	55428	141
53437	229	5420	148, 292	55429	141
53439	229	5420L	148, 292	55431	154, 215
53441	229	5420S	148, 292	55437	215
53443	229	5420XL	148, 292	55439BPTB	153
53715SEN	229	5425M	149	55448	156
53716	228	5425XL	149	55452RTB	155
53717	228	5426L	149	55454DHB	156
53718	228	5426M	149	55455M	153
53719	228	5426XL	149	55456BPL	153
53720	228	54436	166	55460	129, 144
53721	228	54437	166	55461	129, 144
53722	228	54438	166	55468	129, 144

Item	Page	Item	Page	Item	Page
55469	154	56117	110	57060	88
55470	162	56119	108	5707	101, 146
55474	129, 144	56120	104-106	5708	146
55475	153	56203	112	5709L	147
55485	151	56204	112	5709M	147
55487	118	56205	112	5709XL	147
55488	118	56206	111	5710L	147
55489	118	56207	111	5710M	147
55560	161	56208	112	5710XL	147
55563	129, 144	56209	112	5712	101, 146
55564	129, 144	56210	112	5713	146
55597	152	56211	112	5714	146
55598	154	56220	214	5716	146
55599	161	56221	215	5717	146
55600	127	56250	111	5718	145, 147
55601	128	56251	111	5719	145, 147, 171
55625	127	56252	111	573	272
55629	118	56253	111	578	272
5574L	140	56254	111	58000	120
5574S	140	56255	111	58001	120
55895	129	56312	107	58002	120
56000	105	56324	107	58003	120
56001	105	56325	107	58886	160
56002	105	56400	107	58888	160
56003	105, 168	56401	107, 108	58889	157, 164, 168
56004	105	56406	107	58890	160
56005	105	56409	107	5FW07538	293
56006	105	56415	107	5FW10025	293
56007	105	56418	107	5FW17550	293
56008	105	56430	107	5SDSH	293
56009	105	56511	107, 108		
56010	105	56512	108		
56013	105	56513	108	6	
56014	105	56514	108	60	22
56025	104, 106	56515	108	60009	119
56026	213	56516	108	600-1	51, 168
56027	213	56517	108	60010	119
56028	213	56999	85, 113	60011	119
56029	215	5700	145	600-12	51
56034	214	57000	88	60015	119
56055	104	57005	88	60025	119
56056	104	5701	145, 147	60027	119
56057	104	57010	88	60028	118
56058	104	5702	145	60030	118
56059	104	5703	145, 147	60031	118
5606	254	57032	63	600-4	51, 53, 168-169
56107	106	5704L	147	60046	117
56108	110	5704M	147	60047	117
56110	110	5704XL	147	60049	117
56115	104-106	5705	147, 170-171	60053	117, 168-170
56116	104-106	5706	146, 147	60054	117

Item	Page	Item	Page	Item	Page
60055	117	608-3	50	63041	33
60056	117, 170	608-4	50	63041TH	33
60057	117	608-6	50	63045	33
600-6	51	608-8	50	63047	33
60060	119	610	66	630-4MM	66
600-8	51	610-1/4	66	630-5/16	66, 168-170
601-10	51	610-1/4M	65	630-5/16M	65
601-3	51, 168	610-5/16	66	630-5/8	66
601-4	51	610-5/16M	65	63050	31
601-4-INS	42-43, 46	610M	65	63050-EINS	41
601-6	51, 53, 168-169	612-4	54	63050-INS	41, 45-47
601-6-INS	47	612-4-INS	42-43, 46	63055	32
601-7-INS	42-43, 46	613-3	52	630-5MM	66
601-8	51	614-2	52	63060	34
602-10	51	614-3	52	630-6MM	66
60210B	149	614-4	52	630-7/16	66, 168-169
602-12	51	614-6	52	630-7/16M	65
60223B	149	618-1/4M	65	630-7MM	66
602-3	51	618-5/16M	65	630-8MM	66
602-4	51	620-3	52	630-9/16	66
602-4DD	52	620-4	52	630M	65
602-4-INS	42-43, 45-47	620-6	52	631	66
602-6	51, 53, 168-169	620-8	52	63118	36
602-7DD	52	621-6	52	63124	36
602-7-INS	42-43, 45-46	621-8	52	63130	36
602-8	51	625-24	70	63136	36
602-8-INS	42-43, 45-46	625-32	70	631M	65
603-1	51, 168	626	70	633	66
603-10	51	626-24	70	63314	36
603-3	51, 168, 170-171	626-32	70	63318	36
603-4	51, 53, 171	627-20	70	63324	36
603-4B	55, 168-170	628-20	70	63330	36
6034DD	52	630-1/2	66, 168-169	63336	36
603-4-INS	42-43, 45-47	630-1/2M	65	63342	36
603-6	51	630-1/4	66, 168-170	6334INS	42-43, 45-46
603-7	51	630-1/4M	65	6337INS	42-43, 45-46
6037INS	42	630-10MM	66	635-1/2	64
604-3	50	630-11/32	66, 168-169	635-1/4	64
605-10	51	630-11/32M	65	635-3/8	64
605-4	51, 170-171	630-11MM	66	635-4	64
605-4B	55	63016	32	635-5/16	64
605-6	51, 53, 168-171	63020	32, 179-180	635-6	64
605-6B	55	63028	31	635-7/16	64
605-7-INS	42	630-3/16	66, 168-169	635-9/16	64
605-8	51	630-3/16M	65	63601	34
606-2	50	630-3/8	66, 168-169	63607	34
607-3	50	630-3/8M	65	63700	35
607-3-INS	42	63030	31	63711	34
607-4	50	63035	33	63750	34
608-10	50	63035SC	33	63800ACSR	34
608-2	50	630-4.5MM	66	63RBCHD	36

Item	Page	Item	Page	Item	Page
640-1/2	67	65508	81	65809	80
640-1/4	67	65510	82	65810	80
640-3/16	67	65512	82	65811	80
640-3/8	67	65514	82	65812	80
640-5/16	67	65600	80	65820	80
640-5/8	67	65601	80	65821	80
640-7/16	67	65602	80	65823	80
640-9/16	67	65603	80	65825	80
64306	293	65604	80	65826	80
64309	292	65605	80	65827	80
64310	292	65606	80	65828	80
64311	292	65607	80	65829	80
64312	292	65608	80	65830	80
646-1/2	66	65610	80	65831	80
646-1/2-INS	44	65611	80	65907	80
646-1/2M	65	65613	80	65908	80
646-1/4	66	65614	80	65909	80
646-1/4-INS	44	65615	80	65910	80
646-1/4M	65	65620	80	65911	80
646-11/32	66	65621	80	65912	80
646-11/32-INS	44	65622	80	65913	80
646-11/32M	65	65623	80	65914	80
646-3/16	66	65700	80	65915	80
646-3/16-INS	44	65701	80	65916	80
646-3/16M	65	65702	80	65917	80
646-3/8	66	65703	80	65918	80
646-3/8-INS	44	65704	80	65919	80
646-3/8M	65	65705	80	660	50
646-5/16	66	65706	80	66001	86
646-5/16-INS	44	65707	80	66004	86
646-5/16M	65	65708	80	661	50, 171
646-5/8	66	65711	80	66100	289
646-5/8-INS	44	65712	80	66140	289
646-7/16	66	65713	80	66141KIT	254
646-7/16-INS	44	65714	80	66142	289
646-7/16M	65	65715	80	66143	289
646-9/16	66	65716	80	66144	289
646-9/16-INS	44	65717	80	66145	289
646M	65	65720	80	66146	289
647	66	65721	80	661-4-INS	42
647M	65	65722	80	66174	289
650	71, 168	65723	80	66177	289
65064	54	65724	80	661-7-INS	42
650DD	71	65800	80	66183	289
65129	54	65801	80	662	50, 168-171
65131	54	65802	80	662-4-INS	42
65160	66	65804	80	662-7-INS	42
65500	81	65805	80	663	50
65502	81	65806	80	66310	290
65504	81	65807	80	66311	290
65506	82	65808	80	66312	290

Item	Page	Item	Page	Item	Page
66313	290	68415	76-77	69193	198
66320	290	68416	76-77	69194	198
66321	290	68417	76-77	69401	209
66322	290	68418	76-77	69406	144, 210
66323	290	68419	76-77	69407	144, 210
66324	290	68420	76-77	69408	144, 210
66325	290	68421	76-77	69409	198, 200
66340	290	68422	76-77	69410	199
66342	290	68423	76-77	69411	203
66343	290	68424	76-77	69417	200
66344	290	68425	76-77	69435	199
66385	71	68450	79	69450	209
66400	221	68452	79	69451	209
665	50	68460	79	69454	209
666	50	68461	79	69455	209
667	50	68462	79	69457	209
668	50	68463	79		
670-3	53	68464	79		
670-6	53, 168-170	68465	79	7	
67100	52	68466	79	70	22
67101	60	68500	78	70035	62
671-6	53	68502	78	70155	61
68005	85, 178	68507	78	701-S	233
68200	83	68508	78	702	234
68201	83	68509	78	70200	69
68202	83	68510	78	70204	69
68203	83	68511	78	70205	69
68204	83	68512	78	70206	69
68205	83	68513	78	70207	69
68206	83	68514	78	70208	69
68221	83	68515	78	70209	69
68222	83	68517	78	70210	69
68234	84	68519	78	70211	69
68236	84	69028	199	702-12	233
68238	84	69031	198	70220	63
68240	84	69032	198	70229	63
68242	84	69033	198	70245	69
68244	84	69034	198	70255	69
68245	84	69035	198	703	234
682-6	53	69105	203	704	234
68309	84, 222	69127	200	705	234
68310	84	69131	200	70571	94
68400	77	69133	200	70572	94
68402	77	69140	199	70573	94
68404	77	69142	199	70574	94
68406	77	69144	199	70575	94
68410	76-77	69146	199	70579	94
68411	76-77	69149	198	70580	94
68412	76-77	69190	200	70581	94
68413	76-77	69191	198	70582	94
68414	76-77	69192	198	70586	94

Item	Page	Item	Page	Item	Page
B				D	
BAT20-12T165	283	BD306	61	D2000-28	12
BAT20-12T1651	283	BD308	61	D200028GLW	12
BAT20-716	282	BD408	61	D2000-28-INS	39, 45-46
BAT20-7161	282	BD410	61	D2000-48	13
BAT20-7T	284	BD412	61	D2000-48-INS	39, 45-47
BAT207T1	284	BL10	95	D2000-49	13
BAT207T10	284	BL12	95	D2000-7	8
BAT20-7T11	284	BL14	95	D2000-7CST	10
BAT20-7T12	284	BL16	95	D2000-8	8
BAT207T13	284	BL2	95	D2000-9NE	8, 171
BAT207T134H	284	BL20	95	D2000-9NECR	9
BAT20-7T14	284	BL24	95	D20009NEGLW	8
BAT207T14H	284	BL4	95	D2000-9NE-INS	39, 45, 46, 47
BAT207T144H	284	BL5	95	D2000-9NETH	9
BAT207T16	284	BL6	95	D2000-9NETP	9, 113
BAT207T17	284	BL7	95	D2000-9ST	10
BAT207T18	284	BL8	95	D201-7CST	10
BAT207T2	284	BL9	95	D201-7CSTA	10
BAT207T23	284	BLK12	96, 168	D201-7CSTT	10
BAT207T234H	284	BLM10	95	D201-7NE	10
BAT207T24H	284	BLM15	95	D201-8	10
BAT207T3	284	BLM2	95	D201-8NE	10
BAT207T34H	284	BLM3	95	D202-6	14
BAT207T4	284	BLM4	95	D202-6C	14
BAT207T4H	284	BLM5	95	D203-6	17
BAT207T44H	284	BLM6	95	D203-6C	17
BAT207T5	284	BLM8	95	D203-6H2	17, 19
BAT207T54H	284	BLMK10	96	D203-6-INS	40, 46
BAT207T6	284			D203-7	17
BAT207T7	284	C		D203-7C	17
BAT207T9	284	CL110	194-195, 198, 209	D203-7-INS	40, 46
BAT20-G1	282	CL110KIT	198	D203-8	16, 169,-171
BAT20-G10	282	CL150	196	D203-8-GLW	16
BAT20G104H	282	CL200	199	D203-8-INS	40, 45
BAT20G14H	282	CL210	194-195, 199, 209	D203-8N	16
BAT20-G2	282	CL2300	199	D203-8NCR	16
BAT20G24H	282	CL310	199, 209	D203-8N-INS	40, 46-47
BAT20-G4	282	CL312	194-195, 199, 209	D209-4C	14
BAT20-G5	282	CL330	199, 209	D209-5C	14
BAT20-G7	282	CL360	196	D210-6C	14
BAT20-G8	282	CL380	194-195	D213-8NE	8
BAT20-G9	282	CL450	194-195, 200	D213-9	8
BD111	61	CL600	194-195, 200, 209	D213-9NE	8
BD122	61	CL700	194-195, 199, 200, 209	D213-9NE-CR	9
BD133	61	CL800	194-195, 200, 209	D213-9NE-CR-INS	39
BD144	61	CL900	194-195, 200	D213-9NE-INS	39, 47
BD146	61			D213-9NETH	9
BD156	61			D213-9NETP	9, 113, 169-171
BD284	61				

Item	Page	Item	Page	Item	Page
D213-9NETT	8	D502-6TT	21	HD213-9NETH	9
D213-9ST	10	D504-10	21	HVNCVT-1	211
D213-9STT	10	D504-10B	21	HVNCVT-2	211
D220-7	14	D504-12	21		
D220-7-INS	39, 46	D504-12B	21		
D227-7C	15	D504-7	21		
D228-7	12	D506-4	75	I	
D228-8	12	D507-10	75, 170	IR07	206
D228-8-INS	39, 47	D507-12	75, 168	IR10	207
D228-8TT	12	D507-6	75	IR5	207
D2291	20	D507-8	75, 168		
D230-4C	15	D509-8	75	J	
D232-8	20	D511-10	22	J1005	29, 168
D234-6	19	D511-6	22	J1100L	217
D234-6C	19	D511-8	22	J1101R	217
D238-8	13	D514-8	22	J1102S	217
D240-6	14	D528V	14	J12098	11
D243-8	13	D86930	76, 222	J2000-28	12
D244-5C	14	D86932	75, 222	J2000-48	13, 168, 170
D245-5	14	D86934	75, 222	J2000-59	12
D248-8	13, 169, 170, 171	D86936	75, 222	J20008	8
D248-8-GLW	13	DK06	220, 245	J2000-9NE	8
D248-8-INS	39			J2000-9NECR	9
D248-9ST	13	E		J2000-9NECRTP	9, 113
D248-9STT	13	ET05	206	J2000-9NETP	9, 113, 168, 170
D252-6	14	ET10	206	J20017NE	10
D252-6SW	14	ET110	205	J203-6	17, 168
D257-4	14	ET120	205	J203-7	17
D257-4C	14	ET130	204	J203-8	16
D259-4C	14	ET250	201	J203-8N	16, 168, 170
D275-5	15	ET300	203	J206-8C	16
D295-4C	14	ET40	201	J207-8CR	16
D301-6	17	ET45	201	J2100L	217
D301-6C	17	ET500	208	J2101R	217
D302-6	18	ET510	208	J2102S	217
D307-51/2C	17	ET60	201	J2103S	217
D310-6C	18	ET900	204	J2138NE	8
D318-51/2C	18	ET910	204	J213-9NE	8
D320-41/2C	18	ET920	204	J213-9NECR	9
D321-41/2C	18			J2139NECRN	9
D322-41/2C	18	H		J213-9NETP	9, 113
D327-51/2C	17	H1802-30	259	J215-8CR	11
D333-8	20, 114	H1802-30S	259	J228-8	12
D335-51/2C	18	H1802-30SR	259	J248-8	13
D502-10	21, 169, 170, 171	H1802-30SSR	259	J502-10	21, 168, 170
D502-10-INS	40, 45, 46	H267	257	J63050	31, 168
D502-10TT	21	H268	257	JTH410E	91
D502-12	21	HD2000-9NE	8	JTH4E06	91
D502-12TT	21	HD213-9NE	8	JTH4E07	91
D502-16	21			JTH4E08	91
D502-6	21			JTH4E09	91

Item	Page	Item	Page	Item	Page
JTH4E10	91	JTH6T15	93	KP100-24	280
JTH4E11	91	JTH6T20	93	KP100-36	280
JTH4E12	91	JTH6T25	93	KP150-36	280
JTH4E13	91	JTH6T27	93	KPJ100	280
JTH4E14	91	JTH6T30	93	KPJ50	280
JTH4E15	91	JTH6T40	93	KPJ75	280
JTH4E17	91	JTH910E	91	KPL125-1	280
JTH610E	91	JTH98M	93	KPL150-1	280
JTH610EB	90	JTH9E06	91	KPL200-1	280
JTH67T	93	JTH9E07	91	KPM050	280
JTH68M	93	JTH9E08	91	KPM075	280
JTH68MB	92	JTH9E09	91	KPM100	280
JTH6E06	91	JTH9E10	91	KPS050-2	280
JTH6E06BE	90	JTH9E11	91	KPS062-2	280
JTH6E07	91	JTH9E12	91	KPS075-2	280
JTH6E07BE	90	JTH9E13	91	KPS100-2	280
JTH6E08	91	JTH9E14	91	KPS100-3	280
JTH6E08BE	90	JTH9E15	91	KPS125-2	280
JTH6E09	91	JTH9E17	91	KPS150-2	280
JTH6E09BE	90	JTH9M10	92-93	KPS150-3	280
JTH6E10	91	JTH9M2	92-93	KPS200-2	280
JTH6E10BE	90	JTH9M25	92-93	KPS200-3	280
JTH6E11	91	JTH9M3	92-93	KPS250-2	280
JTH6E11BE	90	JTH9M4	92-93	KPS300-2	280
JTH6E12	91	JTH9M5	92-93	KPS350-2	280
JTH6E12BE	90	JTH9M6	92-93	KSCK100-1	280
JTH6E13	91	JTH9M8	92-93	KSSK125-1	280
JTH6E13BE	90			KT151T	86
JTH6E14	91	K		KT152T	86
JTH6E14BE	90	K12054	24	KT155HD	86
JTH6E15	91	K12055	24	KT155T	86
JTH6E15BE	90	K14	63	KT223X4	85
JTH6E17	91	K1412	25, 168	KT223X4-INS	85
JTH6E17BE	90	K1412CAN	25	KT4500	275
JTH6M10	92-93	K16	63	KT4501	275
JTH6M10BE	92	K19	63	KT4502	275
JTH6M2	92-93	K23	62	KT4600	275
JTH6M25	92-93	K28	62	KT4601	275
JTH6M25BE	92	K34	62	KT4602	275
JTH6M2BE	92	K36	53, 62	KT4650	275
JTH6M3	92-93	K38	62	KT4652	275
JTH6M3BE	92	K44	62	KT4800	275
JTH6M4	92-93	K46	62	KT4801	275
JTH6M4BE	92	K48	62	KT4802	275
JTH6M5	92-93	K7	68	KTSB01	229
JTH6M5BE	92	KN1500PEX	257	KTSB03	229
JTH6M6	92-93	KN1500PEXH	257	KTSB11	229
JTH6M6BE	92	KN1600PEX	257	KTSB14	229
JTH6M8	92-93	KP075-24	280	KTSB15	229
JTH6M8BE	92	KP075-36	280		
JTH6T10	93				

Item	Page	Item	Page	Item	Page
L					
LL10	95	NRHD4	86	S1656-40H	264, 268, 270
LL12	95	NRHDA	86	S1656-50H	264, 270
LL14	95	NRHDA3	86	S1656-60H	264, 270
LL16	95	NRHDA4	86	S166	68
LL2	95	P			
LL20	95	P12	62	S1684-5H	272
LL24	95	P18	61	S1684-74H	272
LL4	95	P202	61	S18	68
LL5	95	P212	61	S-18H	88
LL6	95	P28	61	S20	68
LL7	95	PH115	72	S5	68
LL8	95	PH1355	72	S5118PRS	138
LL9	95	PH162	72	S6	68
LLK12	96	PH2115	72	S66	68
LLM10	95	PH2355	72	S-6H	88
LLM15	95	PH262	72	S7	68
LLM2	95	PH315	72	S8	68
LLM25	95	PH3355	72	S818M	69
LLM3	95	PH362	72	S86	68
LLM4	95	PND125	72	S86M	69
LLM5	95	PND71610	72	S8M	69
LLM6	95	PND7165	72	S9	68
LLM8	95	PND91610	72	SK234	62
LMK10	96	PND9165	72	SL1415	72
M					
MAG2	49, 129	R			
MM100	198	RT110	203	SRS56036	109
MM1000	198-200	RT210	198, 203	SRS56037	109
MM1300	198-200	S			
MM200	198-199	S10	68	SRS56038	108
MM2000	198-200	S1018	69	SRS56980	108
MM2300	198-200	S1018M	69	SRS56981	108
MM300	197-198, 200, 209	S106	68	SS10	68
MM400	197-200, 209	S106M	69	SS12	68
MM600	197-200, 209	S10M	69	SS8	68
MM6000	198, 199	S11	68	T	
MM700	197-200, 209	S116	68	T1710	29
N					
NCVT-1	198, 202	S12	68	T1715	29
NCVT-2	202	S126	68	TT2	295
NCVT-3	202	S126M	69	V	
NCVT-4IR	202	S-12H	88	VDV000-133	179
NRHD	86	S14	68	VDV001-081	190
NRHD3	86	S146	68	VDV001-833	179
		S16	68	VDV002-818	181
		S1613-40H	272	VDV002-820	181
		S1656-20H	264, 268, 270	VDV011-832	179
		S1656-30H	264, 268, 270	VDV011-852	180
				VDV026-049	19, 177
				VDV026-211	180

Item	Page	Item	Page	Item	Page
VDV026-212	182	VDV501-098	186, 187	VDV826-762	178
VDV026-812	182	VDV501-108	186, 187	VDV826-763	178
VDV026-831	179	VDV501-111	188	VDV999-033	175
VDV027-813	190	VDV501-112	188	VDV999-059	190
VDV100-801-SEN	173	VDV501-113	188	VDV999-064	177
VDV110-003-SEN	173	VDV501-114	188	VDV999-067	190
VDV110-004-SEN	173	VDV501-115	188	VDV999-074	176
VDV110-020	173	VDV501-116	188	VDV999-076	176
VDV110-046	27	VDV501-117	188		
VDV110-061	173, 179-180, 181	VDV501-118	188		
VDV110-095	173	VDV501-815	184		
VDV110-261	173, 182	VDV501-823	186-187		
VDV110-295	173	VDV501-824	186-187		
VDV110-802-SEN	173	VDV501-825	186-187		
VDV113-021	173	VDV501-826	186-187		
VDV113-022	173	VDV501-828	185		
VDV120-005-SEN	173	VDV501-829	185		
VDV200-010	175	VDV512-007	183		
VDV201-040	175	VDV512-056	188		
VDV201-042	175	VDV512-100	181, 183		
VDV205-035	175	VDV512-101	183		
VDV205-036	175	VDV526-052	182-183		
VDV205-039	175	VDV526-054	190		
VDV205-044	175	VDV526-055	188		
VDV211-037	175	VDV770-050	191-192		
VDV211-038	175	VDV770-080	187		
VDV211-041	175	VDV770-827	187		
VDV211-043	175	VDV770-834	188		
VDV211-048	174, 179	VDV812-606	175, 179-181		
VDV211-063	174, 179	VDV812-612	175		
VDV211-100	174	VDV812-615	175, 179		
VDV212-008-SEN	174, 180-181	VDV812-618	175		
VDV212-034	175	VDV812-623	175, 179		
VDV226-005	176, 178	VDV812-624	175		
VDV226-011	178, 182	VDV812-627	175, 181		
VDV226-011-SEN	177, 181-182	VDV813-607	175, 179		
VDV226-107	176, 178-179	VDV813-613	175		
VDV226-110	176, 178	VDV813-616	175, 179		
VDV226-817	181	VDV813-619	175		
VDV327-103	191-192	VDV814-609	175		
VDV427-013	192	VDV826-600	178, 179		
VDV427-015-SEN	190, 192	VDV826-601	178		
VDV427-016-SEN	192	VDV826-602	178		
VDV427-104	190, 191, 192	VDV826-603	178, 179		
VDV427-800-SEN	192	VDV826-604	177		
VDV427-805-SEN	192	VDV826-605	177		
VDV427-807	191	VDV826-611	178		
VDV427-821	191	VDV826-628	178-179, 181		
VDV427-822	191	VDV826-702	178		
VDV500-051	189	VDV826-703	178		
VDV500-060	189	VDV826-728	178		
VDV500-808	189	VDV826-729	178		

BRANDED MERCHANDISING

For a complete line of our
branded merchandise visit
www.kleintools.com/catalog/branded-collection



KLEIN TOOLS®

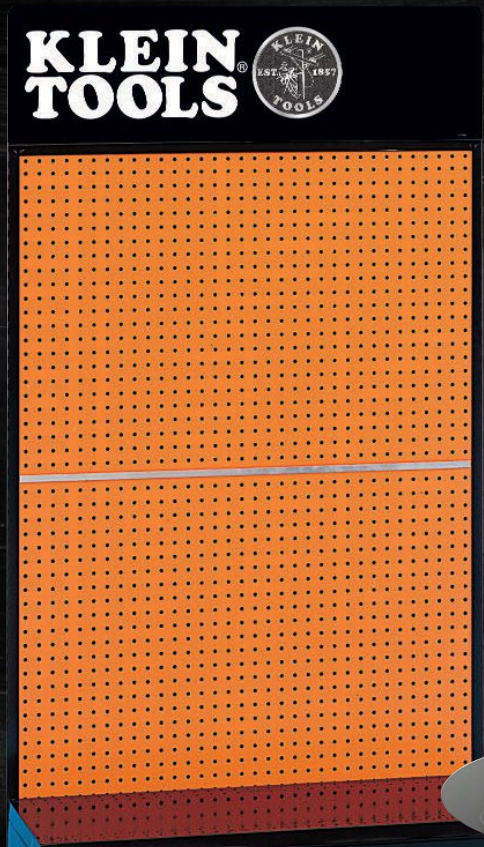

VISUAL MERCHANDISING

For a complete line of our visual merchandising
log in to www.service.kleintools.com.
Visual merchandising is for distributors only.

For over 162 years Klein Tools has been the brand electricians have trusted to Power America!

That trust is invaluable to us, and every day we strive to keep building on that trust. We work hard each day to produce tools to help you perform your job better and more efficiently. We look to you for feedback, good or bad, to continuously improve our product offerings. And we make every effort to develop, design and manufacture these tools right here in the USA. Our commitment is always to you, the customer, and to continue as a US manufacturer of quality tools.



TRADESMAN CLUB



Join the Tradesman Club
at www.kleintradesmanclub.com
for newest products, innovations
and chances to win **FREE** tools



GO MOBILE

Text **KLEIN** to **313131** for
mobile alerts and chances
to win **FREE** tools



KLEIN TOOLS



www.kleintools.com

98342.1903 © 2019 Klein Tools, Inc.