

Product Data Sheet DV4114/2NR

ebmpapst

The engineer's choice



DV4114/2NR

INDEX

1	General	3
2	Mechanics	3
2.1	General.....	3
2.2	Connections.....	3
3	Operating Data	4
3.1	Electrical Operating Data	4
3.2	Electrical Interface - Output.....	5
3.3	Electrical Features	5
3.4	Aerodynamics	7
3.5	Sound Data.....	8
4	Environment	8
4.1	General.....	8
4.2	Climatic Requirements	8
5	Safety	9
5.1	Electrical Safety	9
5.2	Approval Tests	9
6	Reliability	9
6.1	General.....	9

1 General

Fan type	Mixed-flow fan	
Rotating direction looking at rotor	Counterclockwise	
Airflow direction	Air outlet over struts	
Bearing system	Ball bearing	
Mounting position - shaft	Any	

2 Mechanics

2.1 General

Width	119,0 mm	
Height	119,0 mm	
Depth	38,0 mm	
Mass	0,450 kg	
Housing material	Mixed	
Impeller material	Plastic	
Max. torque when mounted across both mounting flanges	Wire outlet corner: 120 Ncm Remaining corners: 150 Ncm	
Screw size	ISO 4762 - M4 degreased, without an additional brace and without washer	

2.2 Connections

Electrical connection	Wires	
Lead wire length	L = 310 mm	
Tolerance	+ - 10,0 mm	
Wire size (AWG)	22	
Insulation diameter	1,70 mm	

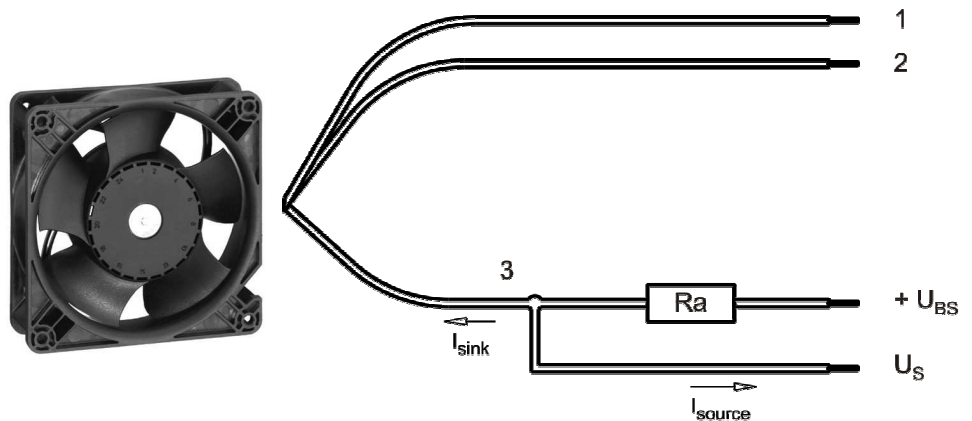

Wire	Color	Operation
1	red	+ UB
2	blue	- GND
3	white	Tacho

The auxiliaries shown on the schematic diagram (which are required for the intended use) are not part of our delivery.

3 Operating Data

3.1 Electrical Operating Data

Measurement conditions: Normal air density = 1,2 kg/m³; Temperature 23°C +/- 3°C; Motor axis horizontal; warm-up time before measuring 5 minutes (unless otherwise specified). In the intake and outlet area should not be any solid obstruction within 0,5 m.

$\Delta p = 0$: corresp. to free air flow (see chapter aerodynamics)
I: corresp. to arithm. mean current value

Note:

No inrush current at Unom means:

The internal electrolytic capacitor 120uF/50V has no resistor or inrush current limitation, essentially the power supply and the type and length of the connecting cable is limiting the Inrush current.

Features	Condition	Symbol	Values		
Voltage range		U	16 V		30,0 V
Nominal voltage		U _N		24,0 V	
Power consumption	$\Delta p = 0$	P	9,8 W	20,5 W	21,3 W
Tolerance	0010		+/- 15 %	+/- 15,0 %	+/- 15,0 %
Current consumption	$\Delta p = 0$	I	610 mA	850 mA	760 mA
Tolerance	0010		+/- 15,0 %	+/- 15,0 %	+/- 15,0 %
Speed	$\Delta p = 0$	n	4.450 1/min	6.000 1/min	6.000 1/min
Tolerance	0010		+/- 10,0 %	+/- 10,0 %	+/- 10,0 %
Starting current consumption				2.800 mA	

3.2 Electrical Interface - Output

Tacho type	/2 (open collector)
------------	---------------------



Features	Note	Values
Tacho operating voltage	U_{BS}	60,0 V Min.: 4,0 V Max.: 60,0 V
Tacho signal Low	$U_{S\ low}$	$I_{sink} : 2\ mA$ $\leq 0,5\ V$
Tacho signal High	$U_{S\ high}$	$I_{source} : 0\ mA$ 60,0 V
Maximum sink current	I_{sink}	$\leq 10\ mA$
External resistor	External resistor R_a from U_{BS} to U_S required. All voltages measured to GND.	
Tacho frequency	$(2 \times n) / 60$	
Tacho isolated from motor	No	
Slew rate		$\Rightarrow 0,5\ V/\mu s$

n = revolutions per minute (1/min)

3.3 Electrical Features

Electronic function	Speed-Controlled	
Reversed polarity protection	Rectifying diode	
Max. residual current at U_N	$I_F \leq 10\ mA$	
Locked rotor protection	Auto restart	
Locked rotor current at U_N	I_{block} approx. 2.600 mA	
Clock signal at locked rotor	t_3 / t_4 typical: 1,2 s / 5,0 s	

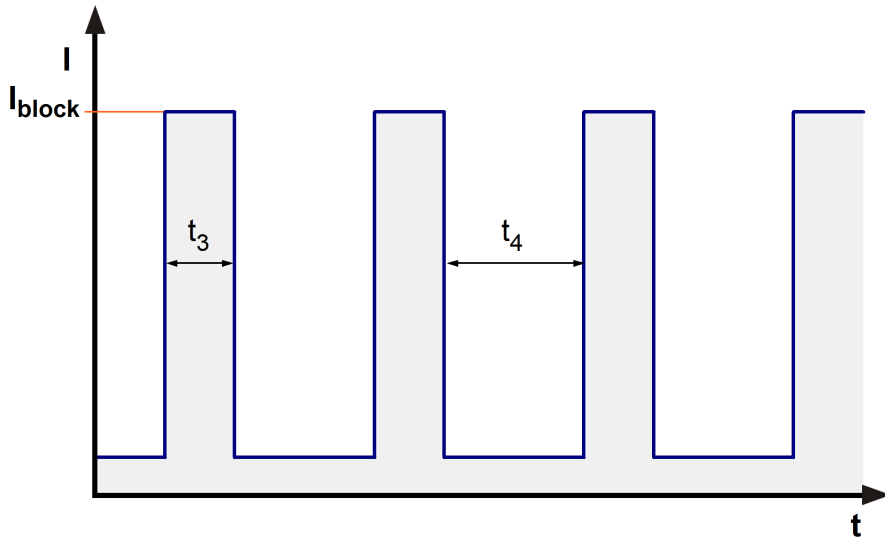

Internal Fuse:

Littlefuse NANO2(R) FUSE; Very fast acting 451 Series; 3 A (Art.-Nr.: 451003)

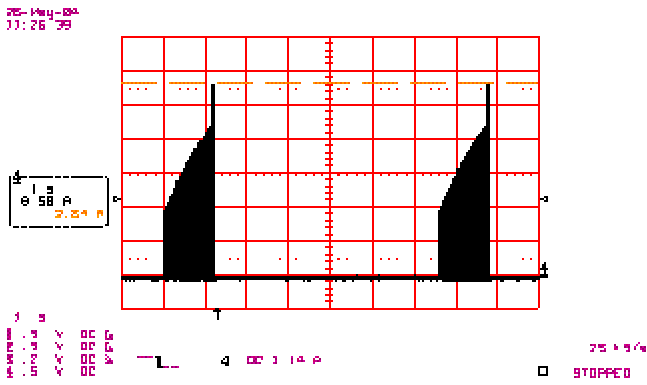

3.4 Aerodynamics

Measurement conditions:

Measured with a double chamber intake rig acc. to DIN EN ISO 5801.

Normal air density = 1,2 kg/m³; Temperature 23°C +/- 3°C;

In the intake and outlet area should not be any solid obstruction within 0,5 m. Motor shaft horizontal.

The information is only valid under the specified test conditions and may be changed by the installation conditions. If there are deviations from the standard test conditions, the characteristic values must be checked under the installed conditions.

a.) Operation condition:

6.000 1/min at free air flow

Max. free-air flow ($\Delta p = 0 / \dot{V} = \max.$)	280,0 m ³ /h	
Max. static pressure ($\Delta p = \max. / \dot{V} = 0$)	380 Pa	

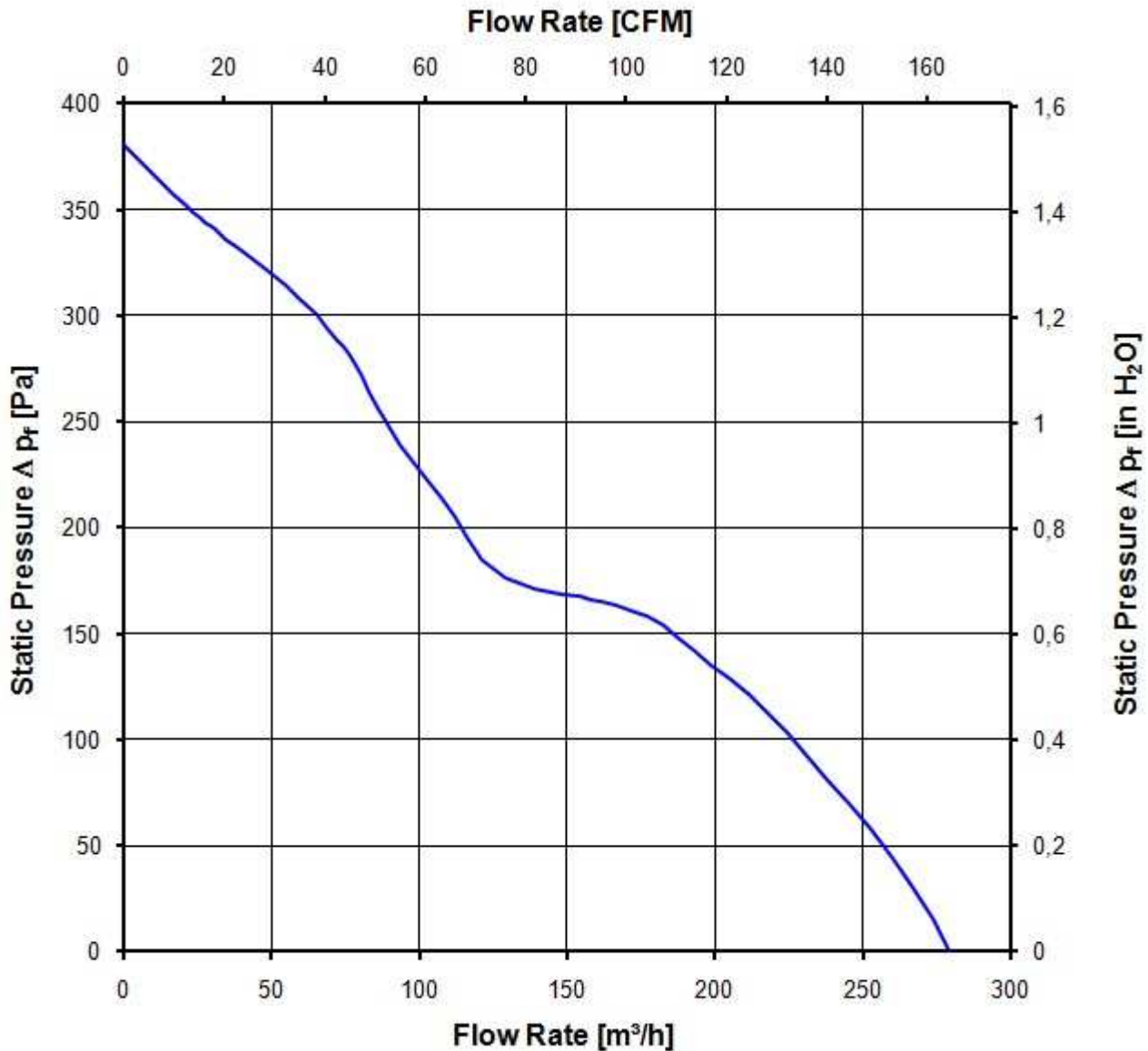

3.5 Sound Data

Measurement conditions: Sound pressure level: 1 meter distance between microphone and the air intake.
 Sound power level: Acc. to DIN 45635 part 38 (ISO 10302)
 Measured in a semianchoic chamber with a background noise level of $L_p(A) < 5 \text{ dB(A)}$
 For further measurement conditions see chapter aerodynamics.

a.) Operation condition:

6.000 1/min at free air flow		
Optimal operating point	185,0 m ³ /h @ 137 Pa	
Sound power level at the optimal operating point	6,9 bel(A)	
Sound pressure level at free air flow, measured in rubber bands	61,0 dB(A)	

4 Environment

4.1 General

Min. permitted ambient temperature TU min.	-20 °C	
Max. permitted ambient temperature TU max.	65 °C	
Min. permitted storage temperature TL min.	-20 °C	
Max. permitted storage temperature TL max.	80 °C	

4.2 Climatic Requirements

Humidity requirements	humid heat, cyclic; according to DIN EN 60068-2-30, 6 cycle	
Water exposure	None	
Dust requirements	Dust check; according to DIN EN 60068-2-68, 6g/m ² d, 1 day	
Salt fog requirements	None	

Permitted application area:

The product is for the use in sheltered rooms with limited controlled temperature. Occasionally condensed water is allowed. Direct exposure to water must be avoided. Saline ambient conditions must be avoided.

Pollution degree 2 (according DIN EN 60664-1)

It occurs only non-conductive pollution. Occassionally, temporary conductivity caused by condensation occurs.

Please require severity levels and specification parameters from the responsible development departments.

5 Safety

5.1 Electrical Safety

Dielectric strength DIN EN 60950 (VDE 0805) and DIN EN 60335 (VDE 0700) A.) Type test Measuring conditions: After 48h of storage at 95% R.H. and 25°C. No arcing or breakdown is allowed! All connections together to ground.	500 VAC / 1 Min.	
B.) Routine test Measuring conditions: At indoor climate. No arcing or breakdown is allowed! All connections together to ground.	850 VDC / 1 Sec.	
Isolation resistance Measuring conditions: After 48h of storage at 95% R.H. and 25°C measured with U=500 VDC for 1 min.	RI > 10 MOhm	
Clearance / creepage distance	1,0 mm / 1,2 mm	
Protection class	III	

5.2 Approval Tests

CE	EC Declaration of Conformity	Yes
EAC	Eurasian Conformity	Yes
UL	Underwriters Laboratories	Yes / UL507, Electric Fans
VDE	Association for Electrical, Electronic and Information Technologies	Yes / Approval acc. to EN 60950 (VDE 0805) - Information technology equipment
CSA	Canadian Standards Association	Yes / C22.2 No. 113 Fans and Ventilators
CCC	China Compulsory Certification	Not applicable

The approval tests are observed to:

U approval max.: 30,0 V @ TU approval max.: 65,0 °C

6 Reliability

6.1 General

Life expectancy L10 at TU = 40 °C	70.000 h	
Life expectancy L10 at TU max.	40.000 h	
Life expectancy L10 acc. to IPC 9591 at TU = 40 °C	117. 500 h	

Copying of this document, and giving it to others and the use or communication of the contents thereof, are forbidden without express authority. Offenders are liable to the payment of damages. All rights are reserved in the event of the grant of a patent or the registration of a utility model or design.

Schutzmerk nach DIN ISO 16016 beachten

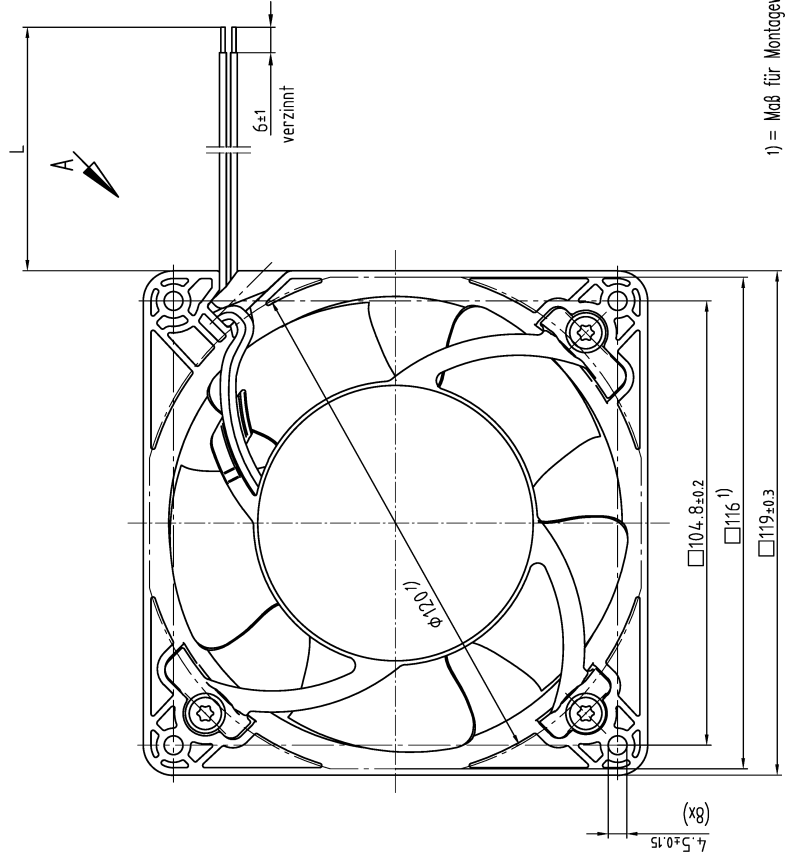
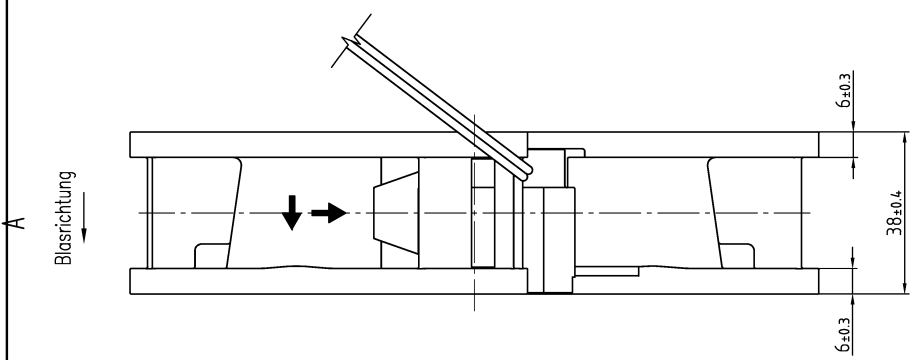

1) = Maß für Montagewand
 Axialspiel bei
 – Kugellagerung (K): 0 (mit Federausgleich)

Anzahl und Länge der Litzen s.Bv.Bl. 1

Tolerierung: Allgemeintoleranzen: DIN 7167 DIN ISO 2768-mK		 PAPST PAPST-MOTOREN GmbH & Co KG D-76125 St. Georgen Germany		Artikel	Material
Bezeichnung	Datum	Name			
Index	Änd.-Nr.			Zichg.-Nr.	Blatt
Geprüft u. zur Verwendung freigegeben von			an	Ers. Zichg.	A3