

EVC154

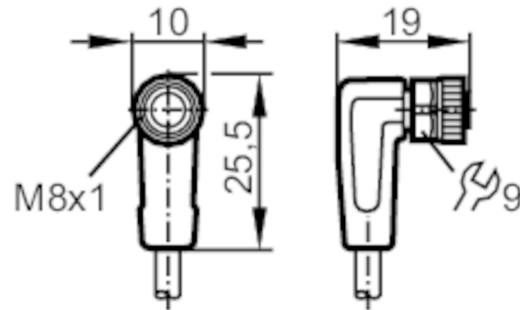

Connecting cable with socket

ADOAF040MSS0005H04



Application

Special feature	Free from silicone; Halogen-free; Gold-plated contacts; Drag chain suitability
Free from silicone	yes

Electrical data

Operating voltage [V]	< 50 AC / < 60 DC
Protection class	III
Max. current load total [A]	3

Operating conditions

Ambient temperature [°C]	-25...90
Note on ambient temperature	cULus: ...80
Ambient temperature (moving) [°C]	-25...90
Note on ambient temperature (moving)	cULus: ...80
Protection	IP 65; IP 67; IP 68; IP 69K

EVC154



Connecting cable with socket

ADOAF040MSS0005H04

Mechanical data		
Weight [g]	116.2	
Dimensions [mm]	19 x 10 x 25.5	
Materials	housing: TPU orange; Sealing: FKM	
Material nut	brass, nickel-plated	
Drag chain suitability	yes	
Drag chain suitability	bending radius for flexible use	min. 10 x cable diameter
	travel speed	max. 3.3 m/s for a horizontal travel length of 5 m and max. acceleration of 5 m/s ²
	bending cycles	> 5 Mio.
	torsional strain	± 180 °/m

Remarks	
Pack quantity	1 pcs.

Electrical connection	
Cable: 5 m, PUR, Halogen-free, black, Ø 3.7 mm; 4 x 0.25 mm ² (32 x Ø 0.1 mm)	

Electrical connection - socket	
Connector: 1 x M8, angled; Locking: brass, nickel-plated; Contacts: gold-plated; Tightening torque: 0.3...0.5 Nm	



Connection

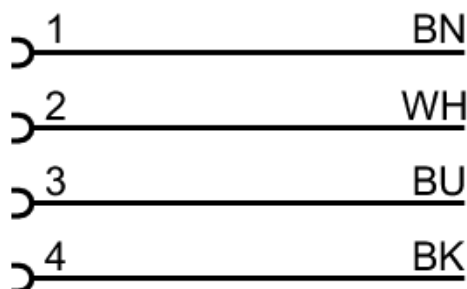

- Core colours :
- BK = black
 - BN = brown
 - BU = blue
 - WH = white