

Actuator And Sensor Cable / PVC
Connection cable
PSW3M-2/TEY

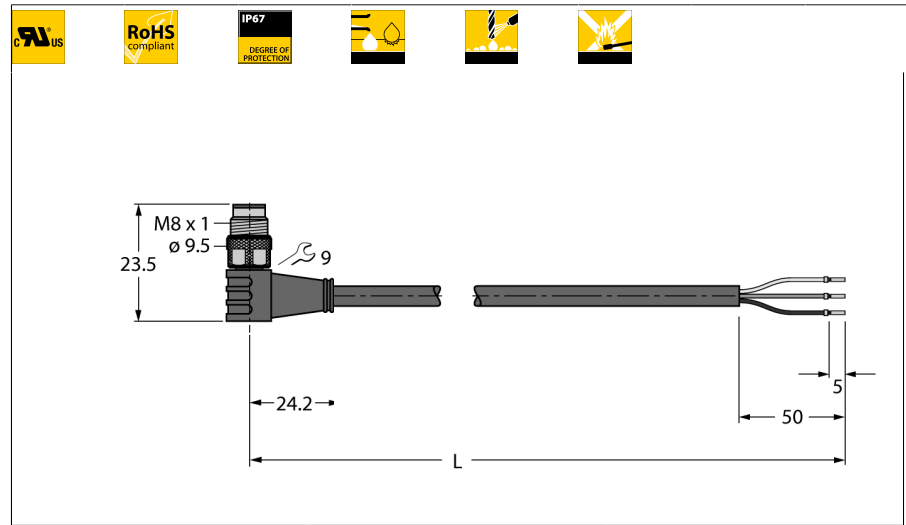

- Male M8, angled, 3-pin
- Sheath material: PVC
- Sheath color: yellow
- Resistant to chemicals and oils
- Flame retardant
- Resistant to acids and alkaline solutions
- Resistant to microbes and hydrolysis
- LABS free
- Approval: cULus
- RoHS conform
- Protection class IP67
- Cable length: 2.0 m

Cable Cross-section

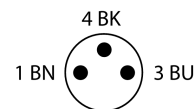
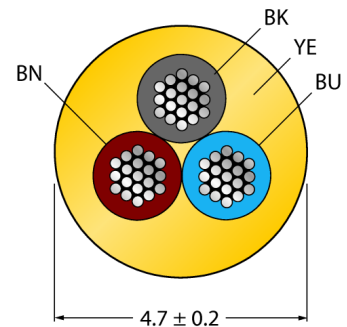

Type designation	PSW3M-2/TEY
Ident no.	6630110
Connector A side	Connector, M8 ⚡ 1, Angled
Number of pins	3
Contacts	Brass, CuZn, Gold-plated
Contact carriers	Plastic, TPU, Black
Grip	Plastic, TPU, Black
Coupling nut/screw	Brass, CuZn, Nickel-plated
Protection class	IP67, A + B side screwed together
Mechanical lifespan	> 100 Mating cycles
Pollution degree	3
Tightening torque	0.5 ... 0.6 Nm (observe max. torque of counter piece!)
General data	
Cable diameter	4.7 ± 0.20mm
Cable length	2 m
Cable quality	PVC
Cable color	Yellow
Core insulation	PVC
Core colors	BN, BU, BK
Core cross-section	3x0.34mm ²
Arrangement of strands	42x0.1 mm
Electrical features at +20 °C	
Current	4 A
Rated voltage	60 V
Insulation resistance	> 30.5 MΩ/km
Test voltage	2000 V
Forward resistance	max. 57 Ω/km
Mechanical and chemical properties	
Bending radius (stationary laying)	> 5 x Ø
Bending radius (flexible use)	> 10 x Ø
Ambient temperature	
Stationary	-40...+105°C
In motion	0...+80°C

General information

Drawing shows design status including hexagon coupling nut (Start of production CW21/2016).

Circuit Diagram

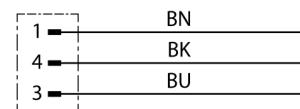

Actuator And Sensor Cable / PVC
Connection cable
PSW3M-2/TEY

Accessories

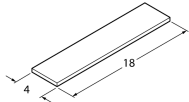
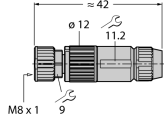
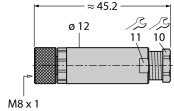
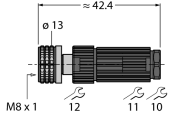
Type code	Ident no.	Description	
Torque-Wrench-Set-AS	6936170	Torque wrench set; handles with adjustable torque 0.4-1.0 Nm, torque wrench for M8 (SW9), fork wrench for M12 (SW 14)	
BLANK-LABEL-FOR-CORDSETS-TEL-TXL	6936206	Label for TEL and TXL cables, length: 18 mm, height: 4 mm, material: polycarbonate (PC), color: white, halogen-free and flame-retardant	
HA5131-0	6905404	Field-wireable female connector, M8 (M8) 1, straight, 3-pin, insulation piercing connection, cable feedthrough 2.5 to 5.1 mm, core cross-section/terminal capacity 0.14 to 0.34 mm ² , plastic housing, metal nut	
B5133-0	6901030	Field-wireable female connector, M8 (M8) 1, straight, 3-pin, screw terminal connection, cable feedthrough 3.5 to 5.0 mm, core cross-section/terminal capacity 0.14 to 0.50 mm ² , plastic housing, metal nut	
H5131-0	6902700	Field-wireable female connector, M8 (M8) 1, straight, 3-pin, pressfit technology, cable feedthrough 4.0 to 5.0 mm, core cross-section/terminal capacity 0.14 to 0.34 mm ² , plastic housing, metal nut	

Actuator And Sensor Cable / PVC
Connection cable
PSW3M-2/TEY

TURCK

Industrial
Automation

Accessories

Type code	Ident no.	Description	
H5231-0	6902800	Field-wireable female connector, M8 -  , 1, angled, 3-pin, pressfit technology, cable feedthrough 4.0 to 5.0 mm, core cross-section/terminal capacity 0.14 to 0.34 mm², plastic housing, metal nut	