

RTKA211650DE0000BU

The RAA211650 is an integrated 60V, 5A synchronous buck regulator with adjustable switching frequency from 200kHz up to 2.5MHz. It supports a wide input voltage range from 4.5V to 60V and adjustable output voltage. The RAA211650 is offered in a 28Ld QFN package. The RTKA211650DE0000BU evaluation board provides a quick and comprehensive platform for evaluating the high-performance features of RAA211650 buck regulator.

The RTKA211650DE0000BU evaluation board operates from a supply voltage of 4.5V to 60V_{DC} with the capability of delivering continuous load of 5A.

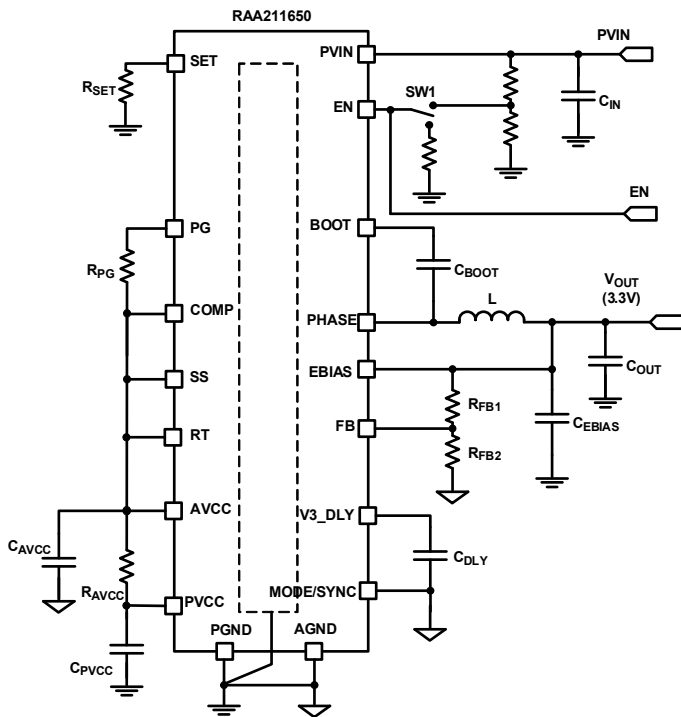

Figure 1. RTKA211650DE0000BU Block Diagram

Features

- Switch selectable EN or option to drive it by external signal
- Internal and external compensation options
- Internal and external RT options
- Internal and external soft-start options
- Frequency synchronization and spread spectrum options
- Adjustable delay time options
- Options to connect EBIAS to V_{OUT} or drive by external source
- Output voltage programmable with external feedback resistors
- Options to use internal feedback resistors for 3.3V V_{OUT}
- Connectors and test points for easy probing and data acquisition

Specifications

This board is configured and optimized for the following operating conditions:

- Input voltage range: 4.5V to 60V
- Output voltage: 3.3V
- Up to 5A output current capability
- Internal set switching frequency of 500kHz
- Internal compensation
- Internal soft-start of 2ms
- Start-up/shutdown delay of 2ms
- EBIAS is connected to V_{OUT}
- Operating temperature range: -40°C to +125°C

Contents

1. Functional Description	3
1.1 Operating Range	3
1.2 Recommended Equipment	3
1.3 Quick Start Guide	3
1.4 Connectors, Test Points, Selection Switches, and Jumper Descriptions	4
1.4.1 Enable	4
1.4.2 Soft-Start	4
1.4.3 Delay	4
1.4.4 Switching Frequency	5
1.4.5 Compensation	5
1.4.6 Spread Spectrum	5
1.4.7 EXT CLK Synchronization	5
1.4.8 3.3V V _{OUT} with Internal Feedback	5
1.4.9 Other Output Voltages	5
1.4.10 EBIAS	5
2. Board Design	6
2.1 Layout Guidelines	7
2.2 Schematic Diagram	8
2.3 Bill of Materials	9
2.4 Board Layout	10
3. Typical Performance Graphs	11
4. Ordering Information	11
5. Revision History	11

1. Functional Description

The RTKA211650DE0000BU provides a comprehensive and versatile platform for you to evaluate functionality and prototype an application of the integrated 60V, 5A synchronous buck regulator RAA211650. This evaluation board includes the options to evaluate most of the features of RAA211650. Either a toggle switch, jumper or 0 Ω jumper resistors have been used to evaluate the features.

1.1 Operating Range

The RTKA211650DE0000BU evaluation board evaluates RAA211650 with PVIN from 4.5V to 60V and continuous load of 5A. For proper functioning of the evaluation board, Renesas recommends operating the board within the specifications.

The inductance and capacitance value of the regulator is chosen for 3.3V V_{OUT} and 500kHz switching frequency. You can replace these components with different values if a different operating condition is required.

Also, you can change the EBIAS to an external source(<12V), soft-start time, start-up delay, compensation, switching frequency, enable spread spectrum, or synchronize to external clock. See the RAA211650 datasheet and design spreadsheet to calculate the components for a required setting.

Updates on the output inductor, capacitors, and R9 may be required with changes on the operating V_{OUT} , load, and switching frequency.

1.2 Recommended Equipment

- Power supply that can deliver 5V or higher with at least 5A source current capability
- Electronic load capable of sinking at least 5A current
- 4-channel oscilloscope with voltage and current probes

1.3 Quick Start Guide

Use the following Quick Setup Guide to configure and power-up the board for proper operation.

1. Set the power supply voltage to 12V and turn off the power supply. Connect the positive output of the power supply to J1 (PVIN) and the negative output to J2 (GND).
2. Connect an electronic load to J5 (V_{OUT}) for the positive connection and J4 (GND) for the negative connection.
3. Place scope probes to V_{OUT} (J3), PHASE (J6), and/or other test points of interest.
4. Toggle the selection switch SW1 to ON position.
5. Set the load current to 0.1A and turn on the power supply. The output voltage should be in regulation with nominal 3.3V output.
6. Slowly increase the load up to 5A. The output voltage should remain in regulation with nominal 3.3V output.
7. Slowly sweep PVIN from 4.5V to 60V. The output voltage should remain in regulation with nominal 3.3V output.
8. Decrease the input voltage to 0V to shut down the regulator.

1.4 Connectors, Test Points, Selection Switches, and Jumper Descriptions

The RTKA211650DE0000BU evaluation board includes I/O connectors, test points, selection switch, and jumpers to provide a comprehensive and versatile platform for evaluation of RAA211650. [Table 1](#) shows the description of them.

Table 1. Connectors, Test Points, Selection Switches, and Jumper Descriptions

Ref DES	Description
J1	Input voltage positive connection
J2	Input voltage return connection
J3	V _{OUT} /GND test points
J4	Output voltage return connection
J5	Output voltage positive connection
J6	PHASE/GND test points
J7	EXT CLK/GND connections
PVIN_1	PVIN test point
GND_2,GND_3,GND_5	GND test points
EN	ENABLE test point
V3_DLY	DELAY test point
EBIAS	EBIAS positive connection
PG	Power-good output test point
SW1	Toggle switch to ENABLE regulator with PVIN

1.4.1 Enable

Switch SW1 enables and disables RAA211650. SW1 in position ON ties EN to PVIN through R1,R2 divider on PVIN. The EN threshold can be changed by changing the values of R1 and R2. With SW1 in OFF position, EN can be driven by external source as well.

1.4.2 Soft-Start

The RTKA211650DE0000BU is set for an internal soft-start of 2ms. To change the soft-start time, remove R10 and update C6 to get the required soft-start time using [Equation 1](#).

$$(EQ. 1) \quad C_6[\text{nF}] = 6.25t_{SS}[\text{ms}]$$

where t_{SS} is the soft-start time in milliseconds.

1.4.3 Delay

The RTKA211650DE0000BU is set for start-up delay of 2ms. To change the delay time, change C8 using [Equation 2](#).

$$(EQ. 2) \quad C_8[\text{nF}] = 4.17t_{DELAY}[\text{ms}]$$

where t_{DELAY} is the delay time in milliseconds.

Note: If no delay is required, mount 0Ω resistor for R14.

1.4.4 Switching Frequency

The RTKA211650DE0000BU is set for an internal default switching frequency of 500kHz. To change the switching frequency, remove R7 and mount R6 using equation 3.

$$(EQ. 3) \quad R_6[k\Omega] = \frac{120258}{f_{SW}^{1.044} \text{ (kHz)}}$$

1.4.5 Compensation

The RTKA211650DE0000BU is set for internal compensation. To change to external compensation, remove R12 and update R15, C9, and C7. Verify the compensation using the design spreadsheet.

1.4.6 Spread Spectrum

To disable the spread spectrum, use a 0Ω resistor for R5 or short the jumper J7. To enable the spread spectrum, use a 0Ω resistor for R4, keep jumper J7 open, and do not put a resistor on R5.

1.4.7 EXT CLK Synchronization

The RAA211650 can be synchronized to an external clock by connecting it to J7. The external clock signal is divided internally to half and PWM clock synchronizes only if the divided external clock frequency is greater than 110% of the frequency set by RT. The external clock should meet the specifications described in the RAA211650 datasheet.

1.4.8 3.3V V_{OUT} with Internal Feedback

The RAA211650 has an internal feedback for a 3.3V V_{OUT} setting. To use this feature, remove R22, C20, R23, and R21, and use a 0Ω resistor for R24.

1.4.9 Other Output Voltages

RTKA211650DE0000BU is set for 3.3V V_{OUT} using R21 and R23. Other output voltages are programmable by updating the values for these resistors. Renesas recommends keeping R21 as 20kΩ and change the value for R23 using [Equation 4](#).

$$(EQ. 4) \quad R_{23} = R_{21} \left(\frac{V_{OUT}}{0.8} - 1 \right)$$

With the change on V_{OUT}, update the output inductor, capacitors, and R9 using the design spreadsheet.

1.4.10 EBIAS

EBIAS improves efficiency for the internal bias supply. The default setting on the board uses V_{OUT} as source of EBIAS. Limit the EBIAS source to 12V. If V_{OUT} is more than 12V, remove R19 and an external EBIAS source (within EBIAS specification) can be used by connecting the source to EBIAS and GND_3 test points. If EBIAS is not used, remove R19 and install a 0Ω resistor for R20.

2. Board Design

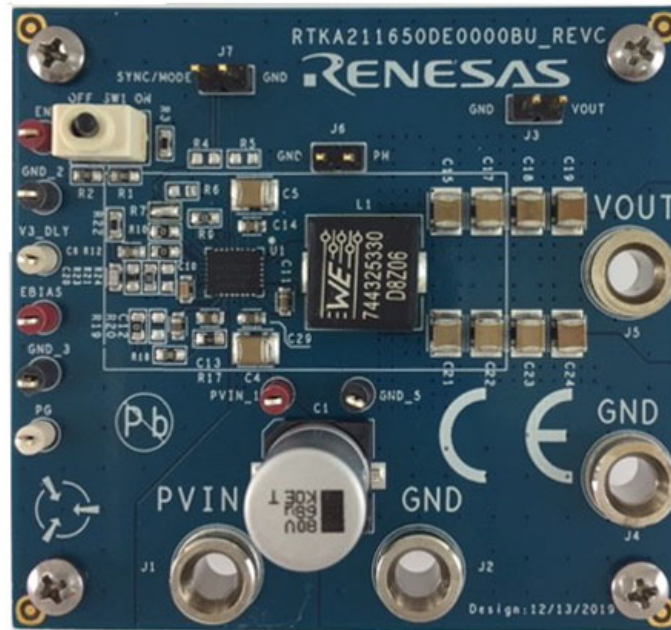

Figure 2. RTKA211650DE0000BU Evaluation Board (Top)

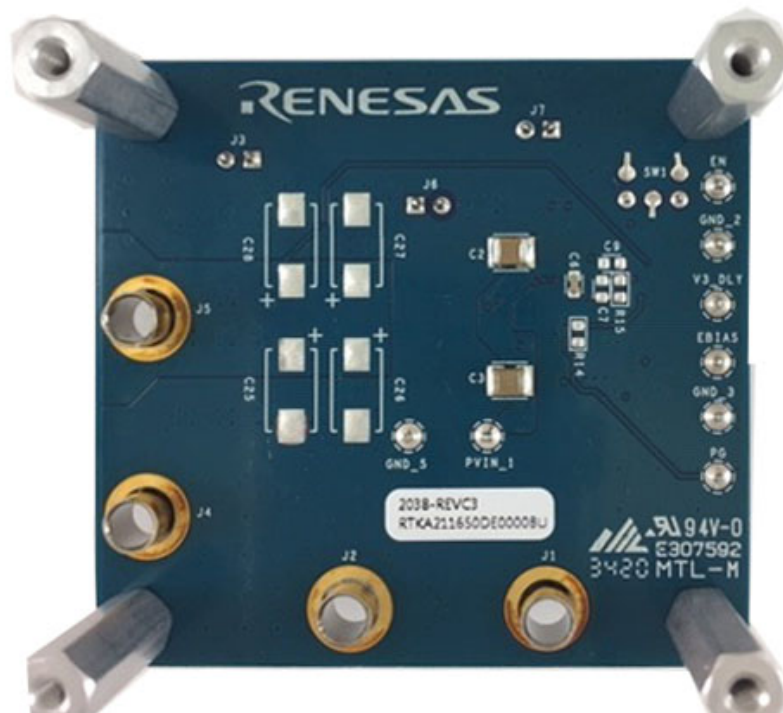

Figure 3. RTKA211650DE0000BU Evaluation Board (Bottom)

2.1 Layout Guidelines

The printed circuit board (PCB) layout is critical for proper operation of the RAA211650. The following guidelines are recommended to achieve good performance.

1. Use multilayer PCB structure to achieve optimized performance. Renesas recommends using a four layer PCB with 2oz copper on outer and 1oz copper in inner layers.
2. Use the combination of a bulk capacitor and smaller ceramic capacitors with low ESL for input capacitors and place them as close as possible to the IC. Place the ceramic input capacitor on the same PCB surface layer.
3. Place the ceramic AVCC capacitor on the same PCB surface layer as the regulator and as close as possible to the AVCC and AGND pins. Use a 1 μ F ceramic capacitor for AVCC and use 1 Ω resistor to connect AVCC to PVCC.
4. Place the ceramic PVCC capacitor on the same PCB surface layer as the regulator and as close as possible to the PVCC and PGND pins.
5. Add plenty of thermal vias under the exposed pad of the regulator for better heat dissipation. Connect the vias to GND planes underneath.
6. Route the output voltage feedback signal away from BOOST and PHASE. Place feedback resistors close to FB pin of the regulator.
7. Place bootstrap capacitor close to the IC between BOOT and PHASE pins on same PCB layer as the regulator. Renesas recommends using a 0.1 μ F ceramic capacitor.
8. The copper area of the PHASE NODE should not be more than needed. Place the inductor close to regulator.
9. Place an output capacitor close to the inductor.
10. Keep SET resistor close to the SET pin. Avoid running other analog signals close to the SET pin or SET resistor.

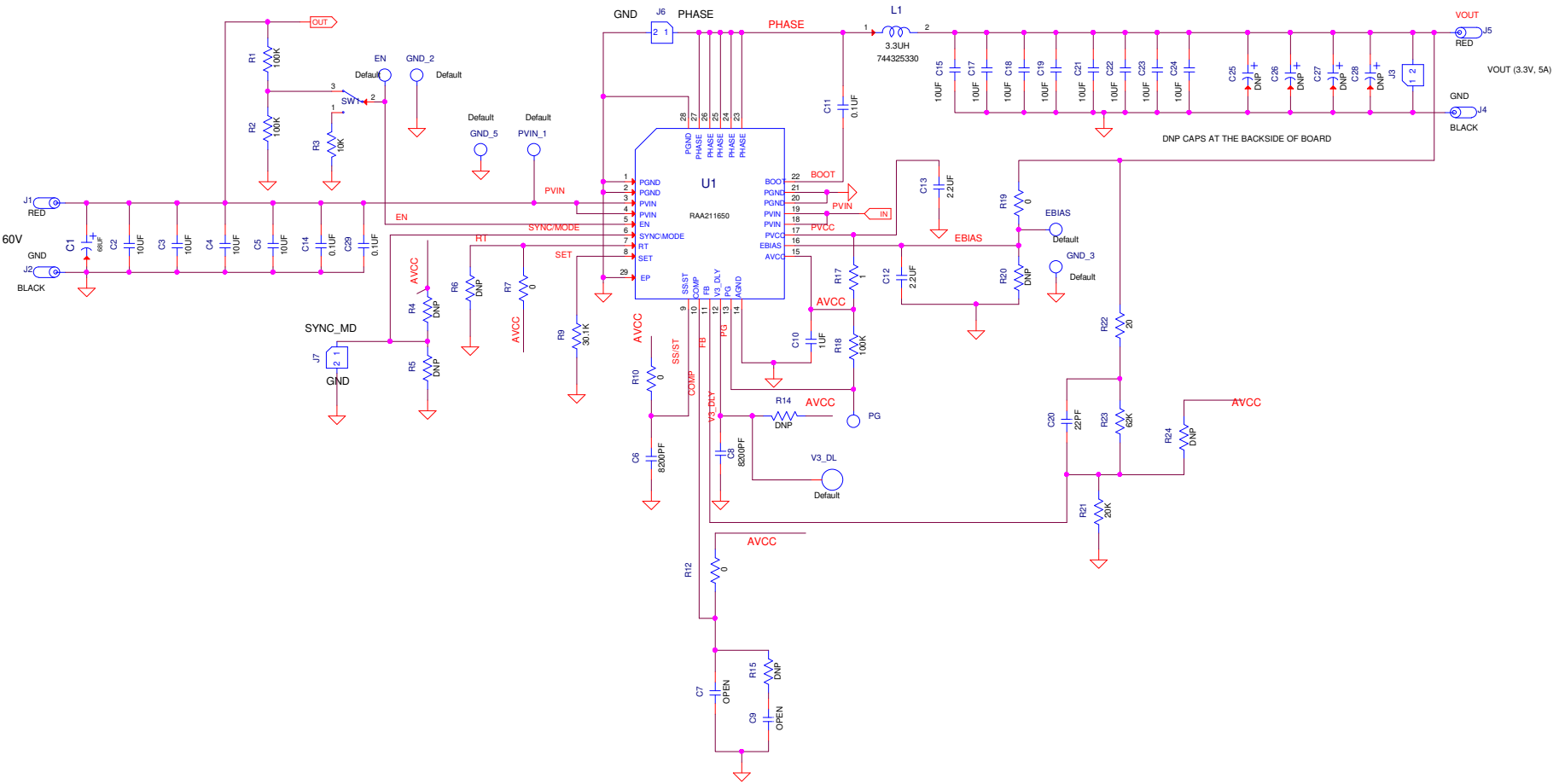

Figure 4. RTKA211650DE0000BU Schematic

2.2 Schematic Diagram

2.3 Bill of Materials

Qty	Reference Designator	Description	Manufacturer	Manufacturer Part Number
1	SW1	SWITCH-TOGGLE, TH, 5PIN, SPDT, 2POS, On-None-On, ROHS	C&K	GT11MCBE
3	EN, EBIAS, PVIN_1	CONN-Miniature Red Test Point, Vertical, ROHS	Keystone	5000
3	GND_2, GND_3, GND_5	CONN-Miniature Black Test Point, Vertical, ROHS	Keystone	5001
2	PG, V3_DLY	CONN-Miniature White Test Point, Vertical, ROHS	Keystone	5002
4	J1, J2, J4, J5	CONN-SOLDER MOUNT BANANA PLUG	Keystone	575-4
3	J3, J6, J7	CONN-HEADER, 2 Pin, BLK, 2.54mm Pitch, ROHS	Samtec	TSW-102-07-G-S
1	L1	COIL-INDUCTOR, SMD,10.2mmx10.5mm, 3.3μH, 12A, 20%, ROHS	Würth Elektronik	744325330
1	R23	RES, SMD, 0603, 62k, 1/10W, 1%, TF, ROHS	Panasonic	ERJ-2RKF6202X
0	R4, R5, R6, R14, R15, R20, R24	RES, SMD, 0603, DNP-Place Holder, ROHS		
1	R22	RES, SMD, 0603, 20Ω, 1/16W, 1%, TF, ROHS	Generic	Various
3	R10, R12, R19	RES, SMD, 0603, 0Ω, 1/10W, 1%, TF, ROHS	Generic	Various
2	R3, R7	RES, SMD, 0603, 010k, 1/10W, 1%, TF, ROHS	Generic	Various
3	R1, R2, R18	RES, SMD, 0603, 100k, 1/10W, 1%, TF, ROHS	Generic	Various
1	R21	RES, SMD, 0603, 20k, 1/10W, 1%, TF, ROHS	Generic	Various
1	R9	RES, SMD, 0603, 30.1k, 1/16W, 1%, TF, ROHS	Generic	Various
1	R17	RES, SMD, 0603, 1Ω, 1/10W, 1%, TF, ROHS	Vishay	RCA06031R00FKEA
0	C25-C28	CAP, SMD, 3x4, DNP-Place Holder, ROHS		
1	C10	CAP, SMD, 0603, 1μF, 10V, 10%, X7R, ROHS	Murata	GRM188R71A105KA61D
3	C11, C14, C29	CAP, SMD, 0603, 0.1μF, 100V, 10%, X7R, ROHS	Murata	GRM188R72A104KA35J
12	C2-C5, C15, C17-C19, C21-C24	CAP, SMD, 1210, 10μF, 100V, 10%, X7S, ROHS	Murata	GRM32EC72A106KE05L
1	C20	CAP, SMD, 0603, 22pF, 50V, 5%, C0G, ROHS	Generic	Various
2	C6, C8	CAP, SMD, 0603, 8.2nF, 25V, 5%, X7R, ROHS	Generic	Various
0	C7, C9	CAP, SMD, 0603, DNP-Place Holder, ROHS	Generic	Various
2	C12, C13	CAP, SMD, 0603, 2.2μF, 10V, 10%, X7R, ROHS	Taiyo Yuden	LMK107B7225KA-T
1	C1	CAP, SMD, 10mm(dia)x12mm(H), ALUM, 68μF, 20%, 80V, ROHS	Vishay	MAL214699705E3
1	U1	IC-BUCK Regulator, 28P, QFN, 4x5, ROHS	Renesas	RAA211650
1	PCB	PWB-PCB, RAA211650, REVC, ROHS	Imagineering Inc	RTKA211650DE0000BU_REVC

2.4 Board Layout

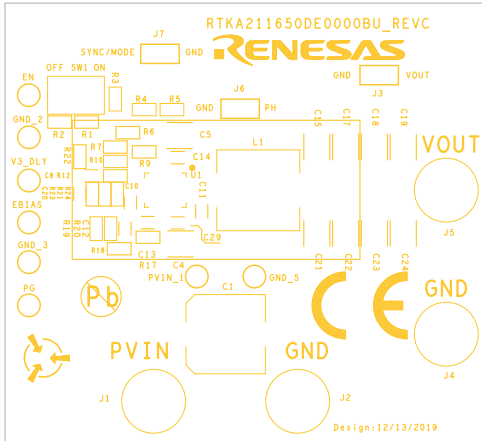

Figure 5. Silkscreen Top Layer

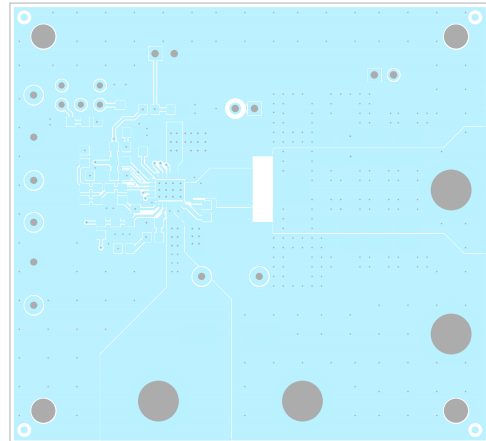

Figure 6. Top Layer

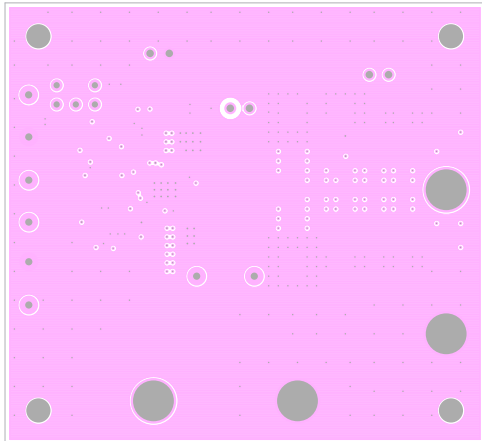

Figure 7. Layer 2

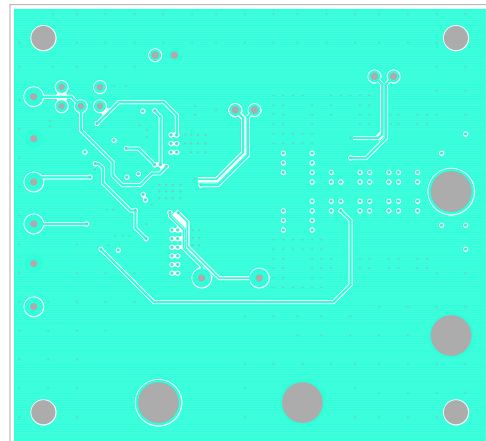

Figure 8. Layer 3

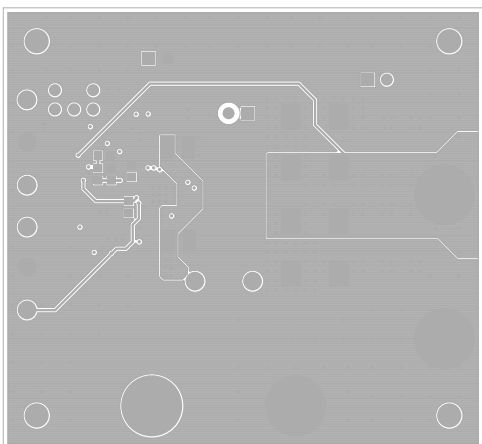

Figure 9. Bottom Layer

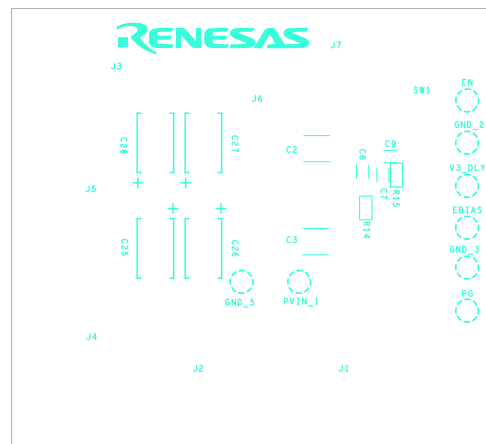

Figure 10. Silkscreen Bottom Layer

3. Typical Performance Graphs

PVIN = 24V, VOUT = 3.3V, fSW = 500kHz, L = 3.3μH, COUT = 80μF, RSET = 30.1kΩ, TA = +25°C, internal compensation, internal soft-start unless otherwise stated.

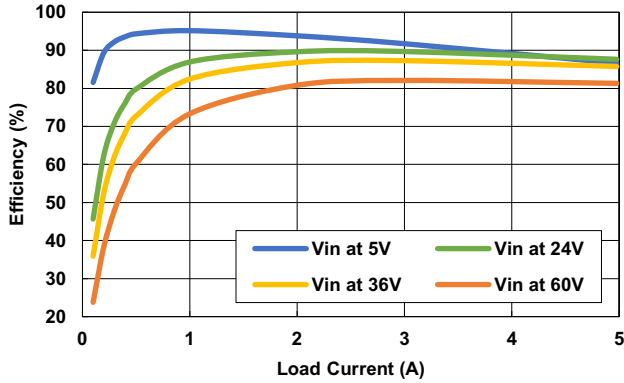

Figure 11. Efficiency vs Load Current (VOUT = 3.3V)

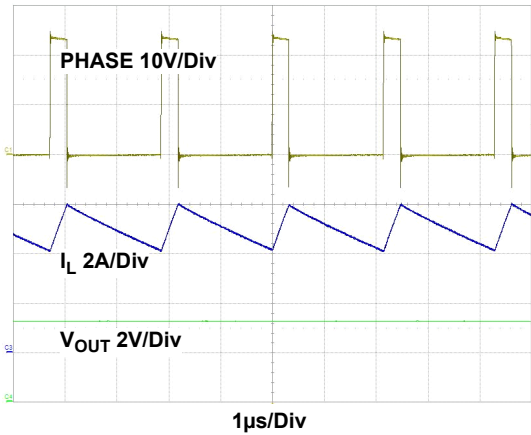

Figure 12. Steady-State Operation IOUT = 5A

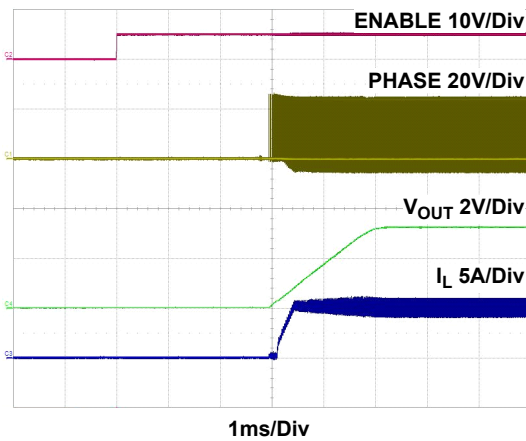

Figure 13. Start-Up through EN, IOUT = 5A

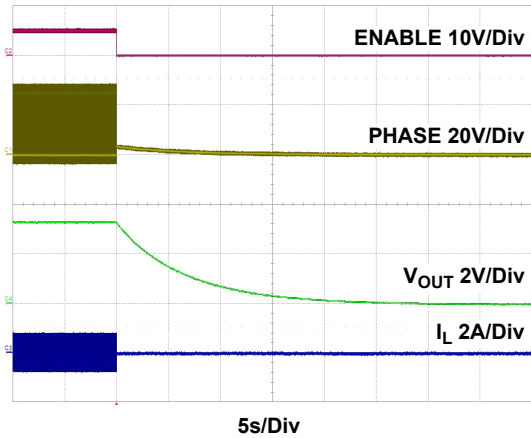

Figure 14. Shutdown through EN, IOUT = 0A

4. Ordering Information

Part Number	Description
RTKA211650DE0000BU	RAA211650 28Ld QFN evaluation board

5. Revision History

Rev.	Date	Description
1.1	May 6, 2021	Changed file number from X0116913 to Renesas format. Applied new template. Removed soft-stop information. Updated Figures 1, 4, and 14.
1.0	Feb 12, 2021	Initial release

IMPORTANT NOTICE AND DISCLAIMER

RENESAS ELECTRONICS CORPORATION AND ITS SUBSIDIARIES (“RENESAS”) PROVIDES TECHNICAL SPECIFICATIONS AND RELIABILITY DATA (INCLUDING DATASHEETS), DESIGN RESOURCES (INCLUDING REFERENCE DESIGNS), APPLICATION OR OTHER DESIGN ADVICE, WEB TOOLS, SAFETY INFORMATION, AND OTHER RESOURCES “AS IS” AND WITH ALL FAULTS, AND DISCLAIMS ALL WARRANTIES, EXPRESS OR IMPLIED, INCLUDING, WITHOUT LIMITATION, ANY IMPLIED WARRANTIES OF MERCHANTABILITY, FITNESS FOR A PARTICULAR PURPOSE, OR NON-INFRINGEMENT OF THIRD PARTY INTELLECTUAL PROPERTY RIGHTS.

These resources are intended for developers skilled in the art designing with Renesas products. You are solely responsible for (1) selecting the appropriate products for your application, (2) designing, validating, and testing your application, and (3) ensuring your application meets applicable standards, and any other safety, security, or other requirements. These resources are subject to change without notice. Renesas grants you permission to use these resources only for development of an application that uses Renesas products. Other reproduction or use of these resources is strictly prohibited. No license is granted to any other Renesas intellectual property or to any third party intellectual property. Renesas disclaims responsibility for, and you will fully indemnify Renesas and its representatives against, any claims, damages, costs, losses, or liabilities arising out of your use of these resources. Renesas' products are provided only subject to Renesas' Terms and Conditions of Sale or other applicable terms agreed to in writing. No use of any Renesas resources expands or otherwise alters any applicable warranties or warranty disclaimers for these products.

(Rev.1.0 Mar 2020)

Corporate Headquarters

TOYOSU FORESIA, 3-2-24 Toyosu,
Koto-ku, Tokyo 135-0061, Japan
www.renesas.com

Contact Information

For further information on a product, technology, the most up-to-date version of a document, or your nearest sales office, please visit:
www.renesas.com/contact/

Trademarks

Renesas and the Renesas logo are trademarks of Renesas Electronics Corporation. All trademarks and registered trademarks are the property of their respective owners.