



PTC thermistors as limit temperature sensors

Probe assemblies

Series/Type: B59052D1*

Date: August 2019

Applications

- Limit temperature sensor

Features

- Sensor with epoxy resin coating
- Tinned leads
- Metal tag for easy mounting
- Lead-free terminals
- Characteristics for sensing temperatures
 $T_{\text{sense}} = 60$ to 120 °C conform with DIN 44081
- Metal tag permits good thermal coupling and thus short response time
- Marking type D1052: Type, manufacturer's logo, T_{sense} temperature in °C and date code YYWW
- RoHS-compatible

Delivery mode

- Type D1052: Cardboard strips with hot-melt adhesive tape in cardboard box (800 pcs.)

General technical data

| | | | | |
|--------------------------------------|---|-----------------------|------------------------------|----------|
| Max. operating voltage | ($T_A = 0 \dots 40$ °C) | V_{max} | 30 | V DC |
| Measuring voltage ¹⁾ | ($T_A = -40$ °C ... $T_{\text{sense}} + 5$ K) | V_{meas} | ≤ 2.5 | V DC |
| Max. measuring voltage ¹⁾ | For T_A see table "Electrical specifications" | $V_{\text{meas,max}}$ | 7.5 | V DC |
| Rated resistance | ($V_{\text{PTC}} \leq 2.5$ V) | R_R | ≤ 100 | Ω |
| Insulating test voltage | (between tags and leads) | V_{ins} | 500 | V AC |
| Operating temperature range | ($V \leq V_{\text{meas,max}}$) | T_{op} | $-40/ T_{\text{sense}} + 23$ | °C |
| Operating temperature range | ($V = V_{\text{max}}$) | T_{op} | 0/+40 | °C |

1) V_{meas} and $V_{\text{meas,max}}$ for 90 °C $\leq T_{\text{sense}} \leq 120$ °C acc. to DIN 44081.

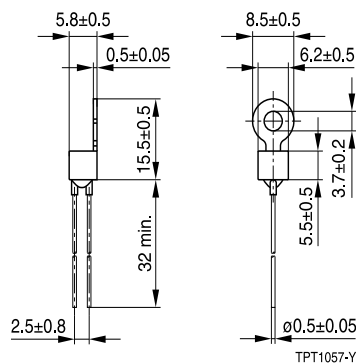
Dimensional drawings
Type D1052

Dimensions in mm

Sensors
Limit temperature sensors, probe assemblies
D1052
Electrical specifications and ordering codes

| T_{sense} | R ($T_{\text{sense}} - 5 \text{ K}$) ($V_{\text{PTC}} \leq 2.5 \text{ V}$) | R ($T_{\text{sense}} + 5 \text{ K}$) ($V_{\text{PTC}} \leq 2.5 \text{ V}$) | R ($T_{\text{sense}} + 15 \text{ K}$) ($V_{\text{PTC}} \leq 7.5 \text{ V}$) | R ($T_{\text{sense}} + 23 \text{ K}$) ($V_{\text{PTC}} \leq 7.5 \text{ V}$) | Stamp code | Ordering code |
|--------------------|--|--|---|---|---------------|-----------------|
| $^{\circ}\text{C}$ | Ω | Ω | Ω | Ω | | |
| Type D1052 | | | | | | |
| 60 | ≤ 570 | ≥ 570 | - | $\geq 10 \text{ k}$ | - | B59052D1060A040 |
| 70 | ≤ 570 | ≥ 570 | - | $\geq 10 \text{ k}$ | - | B59052D1070A040 |
| 80 | ≤ 570 | ≥ 570 | - | $\geq 10 \text{ k}$ | - | B59052D1080A040 |
| 90 | ≤ 550 | ≥ 1330 | $\geq 4 \text{ k}$ | - | - | B59052D1090A040 |
| 100 | ≤ 550 | ≥ 1330 | $\geq 4 \text{ k}$ | - | - | B59052D1100A040 |
| 110 | ≤ 550 | ≥ 1330 | $\geq 4 \text{ k}$ | - | - | B59052D1110A040 |
| 120 | ≤ 550 | ≥ 1330 | $\geq 4 \text{ k}$ | - | - | B59052D1120A040 |

Reliability data

| Test | Standard | Test conditions | $ \Delta R_{25}/R_{25} $ |
|--------------------------------|-------------|--|--------------------------|
| Electrical endurance, constant | IEC 60738-1 | Storage at V_{max} and $T_{\text{op,max}}$ (@ V_{max}) Test duration: 1000 h | $< 25\%$ |
| Damp heat | IEC 60738-1 | Temperature of air: $40 \text{ }^{\circ}\text{C}$ Relative humidity of air: 93% Duration: 56 days Test according to IEC 60068-2-78 | $< 10\%$ |
| Rapid change of temperature | IEC 60738-1 | $T_1 = T_{\text{op,min}}(0 \text{ V})$, $T_2 = T_{\text{op,max}}(0 \text{ V})$ Number of cycles: 5 Test duration: 30 min Test according to IEC 60068-2-14, test Na | $< 25\%$ |
| Vibration | IEC 60738-1 | Frequency range: 10 to 55 Hz Displacement amplitude: 0.75 mm Test duration: $3 \times 2 \text{ h}$ Test according to IEC 60068-2-6, test Fc | $< 5\%$ |

Characteristics (typical)

PTC resistance R_{PTC} versus

PTC temperature T_{PTC} (measured at low signal voltage)

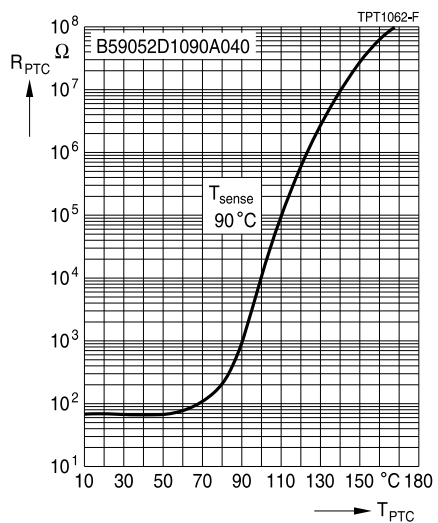
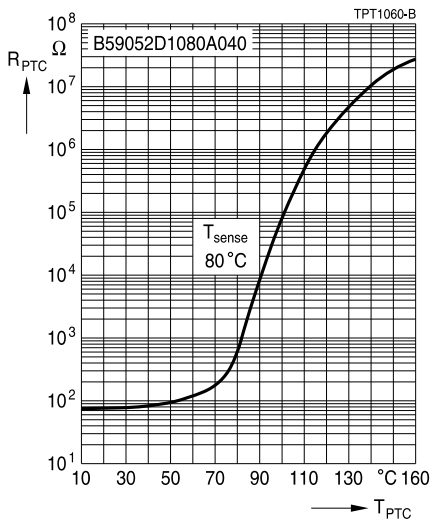
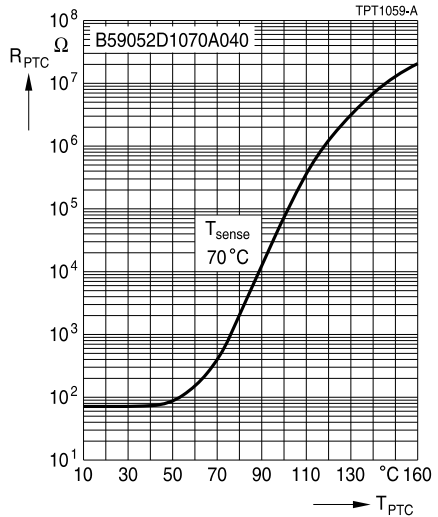
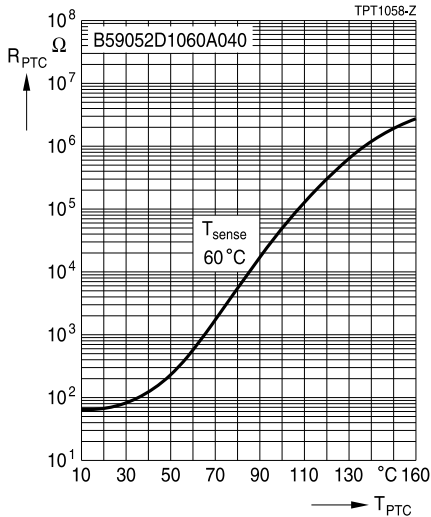

Characteristics (typical)

PTC resistance R_{PTC} versus

PTC temperature T_{PTC} (measured at low signal voltage)

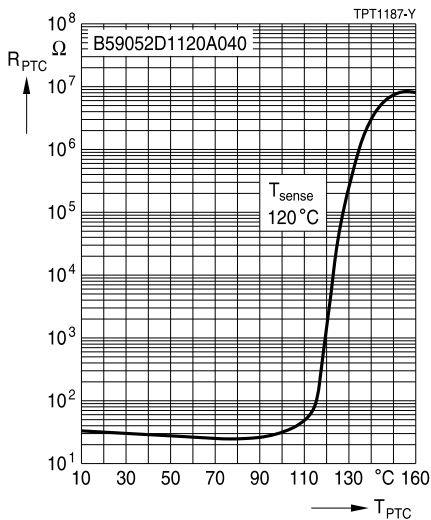
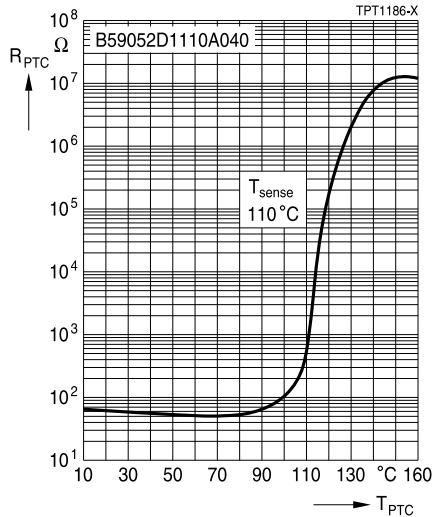
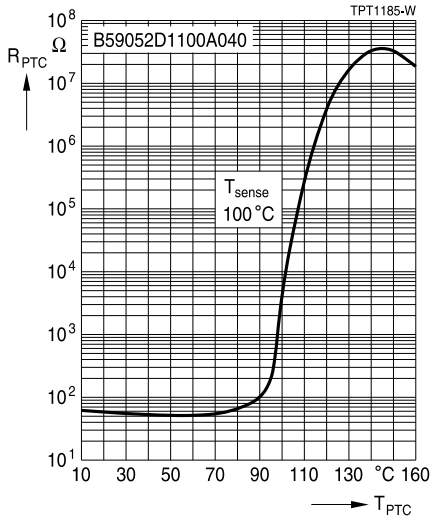

Cautions and warnings

General

- TDK Electronics thermistors are designed for specific applications and should not be used for purposes not identified in our specifications, application notes and data books unless otherwise agreed with TDK Electronics during the design-in-phase.
- Ensure suitability of thermistor through reliability testing during the design-in phase. The thermistors should be evaluated taking into consideration worst-case conditions.

Storage

- Store thermistors only in original packaging. Do not open the package prior to processing.
- Storage conditions in original packaging: storage temperature $-25\text{ }^{\circ}\text{C} \dots +45\text{ }^{\circ}\text{C}$, relative humidity $\leq 75\%$ annual mean, maximum 95%, dew precipitation is inadmissible.
- Avoid contamination of thermistors surface during storage, handling and processing.
- Avoid storage of thermistor in harmful environment with effect on function on long-term operation (examples given under operation precautions).
- Use thermistor within the following period after delivery:
 - Through-hole devices (housed and leaded PTCs): 24 months
 - Motor protection sensors, glass-encapsulated sensors and probe assemblies: 24 months
 - Telecom pair and quattro protectors (TPP, TQP): 24 months
 - Leadless PTC thermistors for pressure contacting: 12 months
 - Leadless PTC thermistors for soldering: 6 months
 - SMDs in EIA sizes 3225 and 4032, and for PTCs with metal tags: 24 months
 - SMDs in EIA sizes 1210 and smaller: 12 months

Handling

- PTCs must not be dropped. Chip-offs must not be caused during handling of PTCs.
- The ceramic and metallization of the components must not be touched with bare hands. Gloves are recommended.
- Avoid contamination of thermistor surface during handling.

Soldering (where applicable)

- Use rosin-type flux or non-activated flux.
- Insufficient preheating may cause ceramic cracks.
- Rapid cooling by dipping in solvent is not recommended.
- Complete removal of flux is recommended.
- Standard PTC heaters are not suitable for soldering.

Mounting

- Electrode must not be scratched before/during/after the mounting process.
- Contacts and housing used for assembly with thermistor have to be clean before mounting. Especially grease or oil must be removed.
- When PTC thermistors are encapsulated with sealing material, the precautions given in chapter "Mounting instructions", "Sealing and potting" must be observed.
- When the thermistor is mounted, there must not be any foreign body between the electrode of the thermistor and the clamping contact.
- The minimum force and pressure of the clamping contacts pressing against the PTC must be 10 N and 50 kPa, respectively. In case the assembly is exposed to mechanical shock and/ or vibration this force should be higher in order to avoid movement of the PTC during operation.
- During operation, the thermistor's surface temperature can be very high. Ensure that adjacent components are placed at a sufficient distance from the thermistor to allow for proper cooling at the thermistors.
- Ensure that adjacent materials are designed for operation at temperatures comparable to the surface temperature of thermistor. Be sure that surrounding parts and materials can withstand this temperature.
- Avoid contamination of thermistor surface during processing.

Operation

- Use thermistors only within the specified temperature operating range.
- Use thermistors only within the specified voltage and current ranges.
- Environmental conditions must not harm the thermistors. Use thermistors only in normal atmospheric conditions. Avoid use in deoxidizing gases (chlorine gas, hydrogen sulfide gas, ammonia gas, sulfuric acid gas etc), corrosive agents, humid or salty conditions. Contact with any liquids and solvents should be prevented.
- Be sure to provide an appropriate fail-safe function to prevent secondary product damage caused by abnormal function (e.g. use VDR for limitation of overvoltage condition).

This listing does not claim to be complete, but merely reflects the experience of TDK Electronics.

Display of ordering codes for TDK Electronics products

The ordering code for one and the same product can be represented differently in data sheets, data books, other publications, on the company website, or in order-related documents such as shipping notes, order confirmations and product labels. **The varying representations of the ordering codes are due to different processes employed and do not affect the specifications of the respective products.** Detailed information can be found on the Internet under www.tdk-electronics.tdk.com/orderingcodes.

Symbols and terms

| Symbol | Term |
|-----------------|---|
| A | Area |
| C | Capacitance |
| C_{th} | Heat capacity |
| f | Frequency |
| I | Current |
| I_{max} | Maximum current |
| I_R | Rated current |
| I_{res} | Residual current |
| I_{PTC} | PTC current |
| I_r | Residual current |
| $I_{r,oil}$ | Residual current in oil (for level sensors) |
| $I_{r,air}$ | Residual current in air (for level sensors) |
| I_{RMS} | Root-mean-square value of current |
| I_S | Switching current |
| I_{Smax} | Maximum switching current |
| LCT | Lower category temperature |
| N | Number (integer) |
| N_c | Operating cycles at V_{max} , charging of capacitor |
| N_f | Switching cycles at V_{max} , failure mode |
| P | Power |
| P_{25} | Maximum power at 25 °C |
| P_{el} | Electrical power |
| P_{diss} | Dissipation power |
| R_G | Generator internal resistance |
| R_{min} | Minimum resistance |
| R_R | Rated resistance @ rated temperature T_R |
| ΔR_R | Tolerance of R_R |
| R_P | Parallel resistance |
| R_{PTC} | PTC resistance |
| R_{ref} | Reference resistance |
| R_S | Series resistance |
| R_{25} | Resistance at 25 °C |
| $R_{25,match}$ | Resistance matching per reel/ packing unit at 25 °C |
| ΔR_{25} | Tolerance of R_{25} |

Sensors
Limit temperature sensors, probe assemblies
D1052

| | |
|---|--|
| T | Temperature |
| t | Time |
| T _A | Ambient temperature |
| t _a | Thermal threshold time |
| T _C | Ferroelectric Curie temperature |
| t _E | Settling time (for level sensors) |
| T _R | Rated temperature @ 25 °C or otherwise specified in the data sheet |
| T _{sense} | Sensing temperature |
| T _{op} | Operating temperature |
| T _{PTC} | PTC temperature |
| t _R | Response time |
| T _{ref} | Reference temperature |
| T _{Rmin} | Temperature at minimum resistance |
| t _S | Switching time |
| T _{surf} | Surface temperature |
| UCT | Upper category temperature |
| V or V _{el} | Voltage (with subscript only for distinction from volume) |
| V _{c(max)} | Maximum DC charge voltage of the surge generator |
| V _{F,max} | Maximum voltage applied at fault conditions in protection mode |
| V _{RMS} | Root-mean-square value of voltage |
| V _{BD} | Breakdown voltage |
| V _{ins} | Insulation test voltage |
| V _{link,max} | Maximum link voltage |
| V _{max} | Maximum operating voltage |
| V _{max,dyn} | Maximum dynamic (short-time) operating voltage |
| V _{meas} | Measuring voltage |
| V _{meas,max} | Maximum measuring voltage |
| V _R | Rated voltage |
| V _{PTC} | Voltage drop across a PTC thermistor |
| α | Temperature coefficient |
| Δ | Tolerance, change |
| δ _{th} | Dissipation factor |
| τ _{th} | Thermal cooling time constant |
| λ | Failure rate |
|  | Lead spacing (in mm) |

Important notes

The following applies to all products named in this publication:

1. Some parts of this publication contain **statements about the suitability of our products for certain areas of application**. These statements are based on our knowledge of typical requirements that are often placed on our products in the areas of application concerned. We nevertheless expressly point out **that such statements cannot be regarded as binding statements about the suitability of our products for a particular customer application**. As a rule, we are either unfamiliar with individual customer applications or less familiar with them than the customers themselves. For these reasons, it is always ultimately incumbent on the customer to check and decide whether a product with the properties described in the product specification is suitable for use in a particular customer application.
2. We also point out that **in individual cases, a malfunction of electronic components or failure before the end of their usual service life cannot be completely ruled out in the current state of the art, even if they are operated as specified**. In customer applications requiring a very high level of operational safety and especially in customer applications in which the malfunction or failure of an electronic component could endanger human life or health (e.g. in accident prevention or lifesaving systems), it must therefore be ensured by means of suitable design of the customer application or other action taken by the customer (e.g. installation of protective circuitry or redundancy) that no injury or damage is sustained by third parties in the event of malfunction or failure of an electronic component.
3. **The warnings, cautions and product-specific notes must be observed.**
4. In order to satisfy certain technical requirements, **some of the products described in this publication may contain substances subject to restrictions in certain jurisdictions (e.g. because they are classed as hazardous)**. Useful information on this will be found in our Material Data Sheets on the Internet (www.tdk-electronics.tdk.com/material). Should you have any more detailed questions, please contact our sales offices.
5. We constantly strive to improve our products. Consequently, **the products described in this publication may change from time to time**. The same is true of the corresponding product specifications. Please check therefore to what extent product descriptions and specifications contained in this publication are still applicable before or when you place an order. We also **reserve the right to discontinue production and delivery of products**. Consequently, we cannot guarantee that all products named in this publication will always be available. The aforementioned does not apply in the case of individual agreements deviating from the foregoing for customer-specific products.
6. Unless otherwise agreed in individual contracts, **all orders are subject to our General Terms and Conditions of Supply**.

Important notes

7. **Our manufacturing sites serving the automotive business apply the IATF 16949 standard.** The IATF certifications confirm our compliance with requirements regarding the quality management system in the automotive industry. Referring to customer requirements and customer specific requirements (“CSR”) TDK always has and will continue to have the policy of respecting individual agreements. Even if IATF 16949 may appear to support the acceptance of unilateral requirements, we hereby like to emphasize that **only requirements mutually agreed upon can and will be implemented in our Quality Management System.** For clarification purposes we like to point out that obligations from IATF 16949 shall only become legally binding if individually agreed upon.
8. The trade names EPCOS, CeraCharge, CeraDiode, CeraLink, CeraPad, CeraPlas, CSMP, CTVS, DeltaCap, DigiSiMic, ExoCore, FilterCap, FormFit, LeaXield, MiniBlue, MiniCell, MKD, MKK, MotorCap, PCC, PhaseCap, PhaseCube, PhaseMod, PhiCap, PowerHap, PQSine, PQvar, SIFERRIT, SIFI, SIKOREL, SilverCap, SIMDAD, SiMic, SIMID, SineFormer, SIOV, ThermoFuse, WindCap are **trademarks registered or pending** in Europe and in other countries. Further information will be found on the Internet at www.tdk-electronics.tdk.com/trademarks.

Release 2018-10