



Contactor relay, 4 NO, 125 V DC, Size S00, ring cable lug connection

product brand name	SIRIUS
product designation	Auxiliary contactor
product type designation	3RH2
General technical data	
size of contactor	S00
product extension auxiliary switch	Yes
insulation voltage with degree of pollution 3 at AC rated value	690 V
degree of pollution	3
surge voltage resistance rated value	6 kV
shock resistance at rectangular impulse	
• at DC	10g / 5 ms, 5g / 10 ms
shock resistance with sine pulse	
• at DC	15g / 5 ms, 8g / 10 ms
mechanical service life (operating cycles)	
• of contactor typical	30 000 000
• of the contactor with added electronically optimized auxiliary switch block typical	5 000 000
• of the contactor with added auxiliary switch block typical	10 000 000
reference code according to IEC 81346-2	K
Substance Prohibitance (Date)	10/01/2009
Ambient conditions	
installation altitude at height above sea level maximum	2 000 m
ambient temperature	
• during operation	-25 ... +60 °C
• during storage	-55 ... +80 °C
relative humidity minimum	10 %
relative humidity at 55 °C according to IEC 60068-2-30 maximum	95 %
Main circuit	
no-load switching frequency	
• at AC	10 000 1/h
• at DC	10 000 1/h
Control circuit/ Control	
type of voltage of the control supply voltage	DC
control supply voltage at DC	
• rated value	125 V
operating range factor control supply voltage rated value of magnet coil at DC	
• initial value	0.8
• full-scale value	1.1
closing power of magnet coil at DC	4 W

holding power of magnet coil at DC	4 W
closing delay	
• at DC	30 ... 100 ms
opening delay	
• at DC	7 ... 13 ms
arcing time	10 ... 15 ms
Auxiliary circuit	
number of NO contacts for auxiliary contacts	4
• instantaneous contact	4
identification number and letter for switching elements	40 E
operational current at AC-12 maximum	10 A
operational current at AC-15	
• at 230 V rated value	10 A
• at 400 V rated value	3 A
• at 500 V rated value	2 A
• at 690 V rated value	1 A
operational current at 1 current path at DC-12	
• at 24 V rated value	10 A
• at 110 V rated value	3 A
• at 220 V rated value	1 A
• at 440 V rated value	0.3 A
• at 600 V rated value	0.15 A
operational current with 2 current paths in series at DC-12	
• at 24 V rated value	10 A
• at 60 V rated value	10 A
• at 110 V rated value	4 A
• at 220 V rated value	2 A
• at 440 V rated value	1.3 A
• at 600 V rated value	0.65 A
operational current with 3 current paths in series at DC-12	
• at 24 V rated value	10 A
• at 60 V rated value	10 A
• at 110 V rated value	10 A
• at 220 V rated value	3.6 A
• at 440 V rated value	2.5 A
• at 600 V rated value	1.8 A
operating frequency at DC-12 maximum	1 000 1/h
operational current at 1 current path at DC-13	
• at 24 V rated value	10 A
• at 110 V rated value	1 A
• at 220 V rated value	0.3 A
• at 440 V rated value	0.14 A
• at 600 V rated value	0.1 A
operational current with 2 current paths in series at DC-13	
• at 24 V rated value	10 A
• at 60 V rated value	3.5 A
• at 110 V rated value	1.3 A
• at 220 V rated value	0.9 A
• at 440 V rated value	0.2 A
• at 600 V rated value	0.1 A
operational current with 3 current paths in series at DC-13	
• at 24 V rated value	10 A
• at 60 V rated value	4.7 A
• at 110 V rated value	3 A
• at 220 V rated value	1.2 A
• at 440 V rated value	0.5 A
• at 600 V rated value	0.26 A
operating frequency at DC-13 maximum	1 000 1/h
design of the miniature circuit breaker for short-circuit protection of the auxiliary circuit up to 230 V	C characteristic: 6 A; 0.4 kA
contact reliability of auxiliary contacts	1 faulty switching per 100 million (17 V, 1 mA)

UL/CSA ratings	
contact rating of auxiliary contacts according to UL	A600 / Q600
Short-circuit protection	
design of the fuse link for short-circuit protection of the auxiliary switch required	fuse gL/gG: 10 A
Installation/ mounting/ dimensions	
mounting position	+/-180° rotation possible on vertical mounting surface; can be tilted forward and backward by +/- 22.5° on vertical mounting surface
fastening method	screw and snap-on mounting onto 35 mm DIN rail
height	57.5 mm
width	45 mm
depth	73 mm
required spacing	
<ul style="list-style-type: none"> • with side-by-side mounting <ul style="list-style-type: none"> — forwards 10 mm — upwards 10 mm — downwards 10 mm — at the side 0 mm • for grounded parts <ul style="list-style-type: none"> — forwards 10 mm — upwards 10 mm — at the side 6 mm — downwards 10 mm • for live parts <ul style="list-style-type: none"> — forwards 10 mm — upwards 10 mm — downwards 10 mm — at the side 6 mm 	
Connections/ Terminals	
type of electrical connection for auxiliary and control circuit	ring terminal lug connection
Safety related data	
product function positively driven operation according to IEC 60947-5-1	Yes
B10 value with high demand rate according to SN 31920	1 000 000; With 0.3 x I _e
proportion of dangerous failures	
<ul style="list-style-type: none"> • with low demand rate according to SN 31920 40 % • with high demand rate according to SN 31920 73 % 	
failure rate [FIT] with low demand rate according to SN 31920	100 FIT
T1 value for proof test interval or service life according to IEC 61508	20 a
protection class IP on the front according to IEC 60529	IP00
Certificates/ approvals	
General Product Approval	



[Confirmation](#)



[KC](#)



EMC	Functional Safety/Safety of Machinery	Declaration of Conformity	Test Certificates
-----	---------------------------------------	---------------------------	-------------------



[Type Examination Certificate](#)



EG-Konf.





[Type Test Certificates/Test Report](#)

[Special Test Certificate](#)

Marine / Shipping



Marine / Shipping	other	Railway	Dangerous Good	Environment
	Confirmation		Vibration and Shock	Transport Information
			Environmental Confirmations	

Further information

Siemens has decided to exit the Russian market (see here).

<https://press.siemens.com/global/en/pressrelease/siemens-wind-down-russian-business>

Siemens is working on the renewal of the current EAC certificates.

Please contact your local Siemens office on the status of validity of the EAC certification if you intend to import or offer to supply these products to an EAC relevant market (other than the sanctioned EAEU member states Russia or Belarus).

Information on the packaging

<https://support.industry.siemens.com/cs/ww/en/view/109813875>

Information- and Downloadcenter (Catalogs, Brochures,...)

<https://www.siemens.com/ic10>

Industry Mall (Online ordering system)

<https://mall.industry.siemens.com/mall/en/en/Catalog/product?mlfb=3RH2140-4BG40>

Cax online generator

<http://support.automation.siemens.com/WW/CAXorder/default.aspx?lang=en&mlfb=3RH2140-4BG40>

Service&Support (Manuals, Certificates, Characteristics, FAQs,...)

<https://support.industry.siemens.com/cs/ww/en/ps/3RH2140-4BG40>

Image database (product images, 2D dimension drawings, 3D models, device circuit diagrams, EPLAN macros, ...)

http://www.automation.siemens.com/bilddb/cax_de.aspx?mlfb=3RH2140-4BG40&lang=en

Characteristic: Tripping characteristics, I²t, Let-through current

<https://support.industry.siemens.com/cs/ww/en/ps/3RH2140-4BG40/char>

Further characteristics (e.g. electrical endurance, switching frequency)

<http://www.automation.siemens.com/bilddb/index.aspx?view=Search&mlfb=3RH2140-4BG40&objecttype=14&gridview=view1>

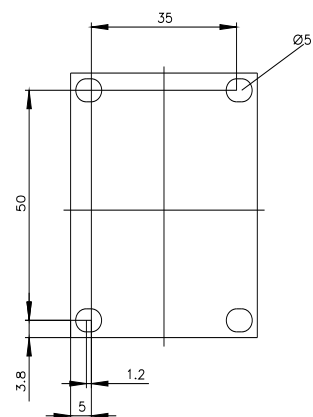
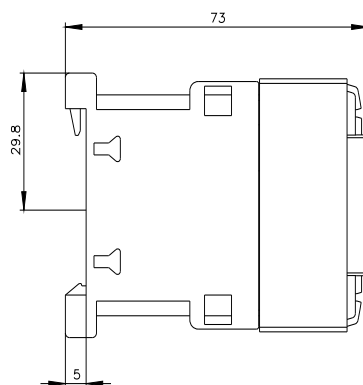
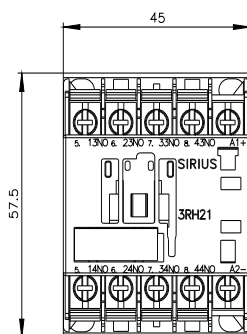

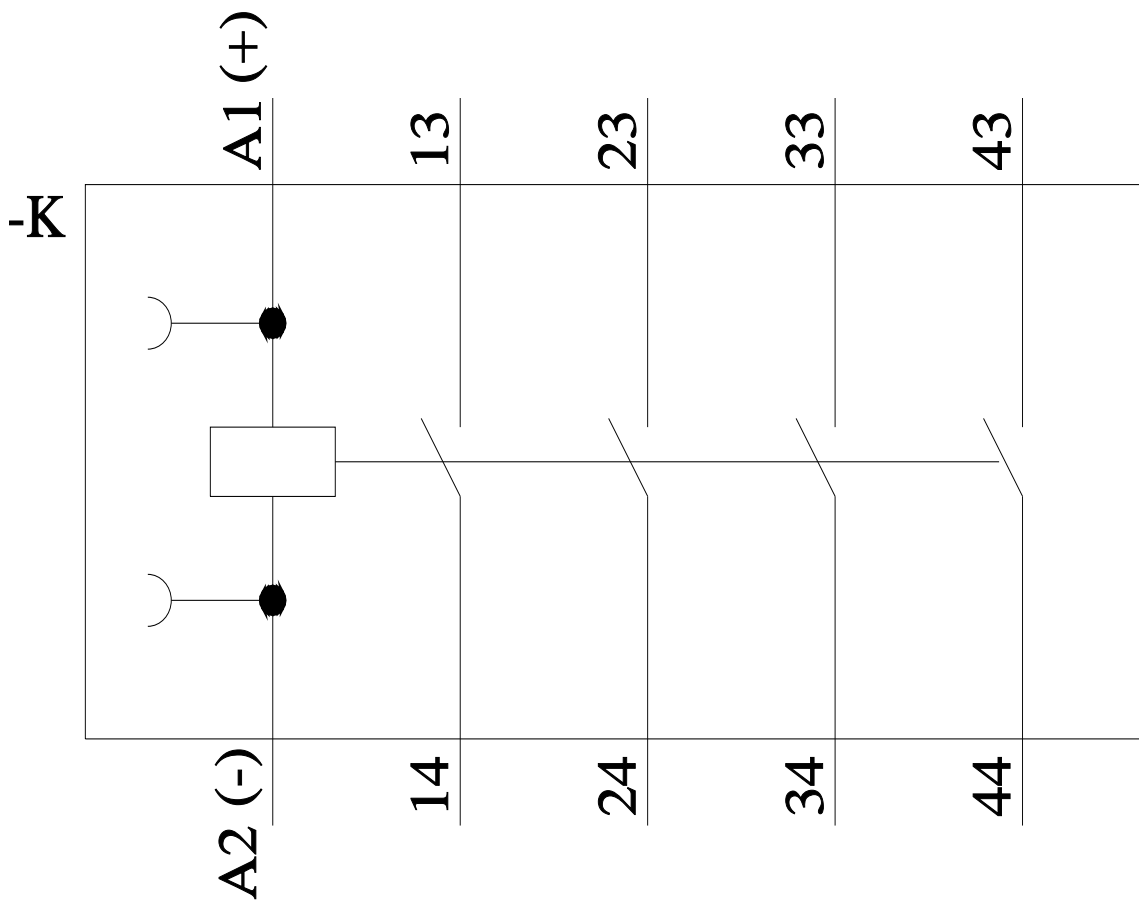
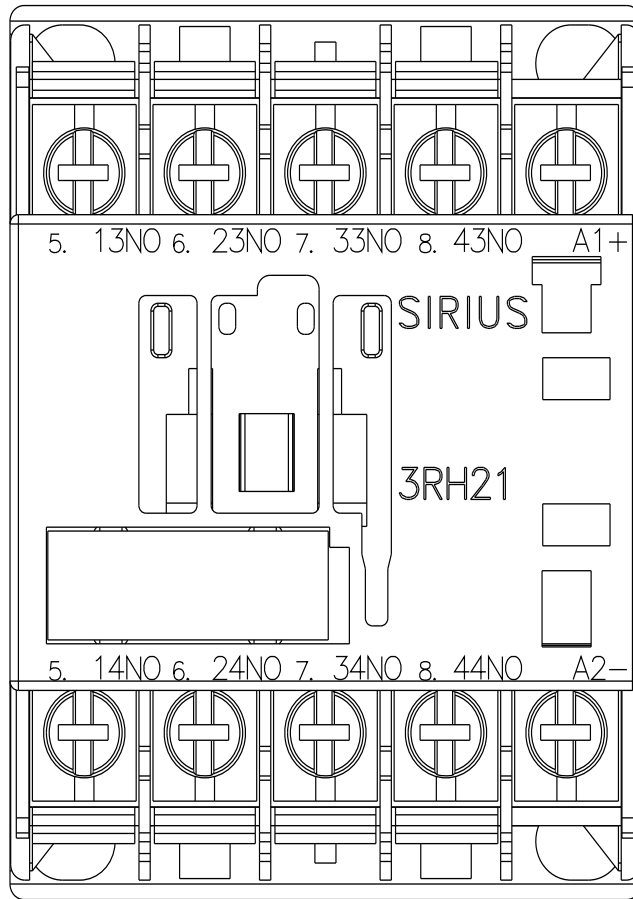

last modified:

11/21/2022