

MSUD VALVE PLUG FORM A 18MM

PUR 3X0.75 GRAY, UL/CSA, drag ch 15m

Form A (18 mm)

230 V AC/DC with LED and suppression

Further cable lengths on request. Plastic housings with good resistance against chemicals and oils. The resistance to aggressive media should be individually tested for your application. Further details on request.

[Link to Product](#)

Illustration

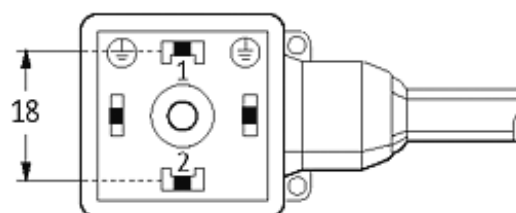
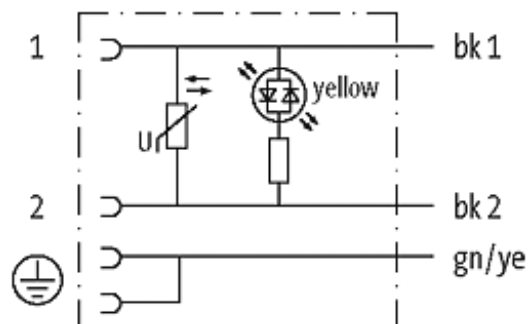



Product may differ from Image

Approvals



Form

18061

Technical Data

Operating voltage	230 V AC/DC $\pm 10\%$
Operating current per contact	max. 4 A
Switch off peak	max. 560 V
Switch off delay time	max. 20 ms
Locking of ports	M3 (recommended torque 0.4 Nm)
Protection	IP67 inserted and tightened (EN 60529)
Housing	Black plastic (gray on request)

Cables

Cable number	236
No./diameter of wires	3 \times 0.75 mm ²
Wire isolation	PP (bk, num, gnye)
C-track properties	5 Mio.
Torsion	2 Mio. \pm 180°/m
Jacket Color	gray
Shore hardness outer jacket	90 \pm 5A
Material (jacket)	PUR (UL/CSA)
Outer diameter	approx. 5.9 mm
Bend radius (fixed)	5 \times outer \varnothing
Bend radius (moving)	10 \times outer \varnothing
Temperature range (fixed)	-40...+80 °C
Temperature range (mobile)	-25...+80 °C

Commercial data

country of origin	CZ
-------------------	----

customs tariff number	85444290
minimum order quantity	1