

# E3M152

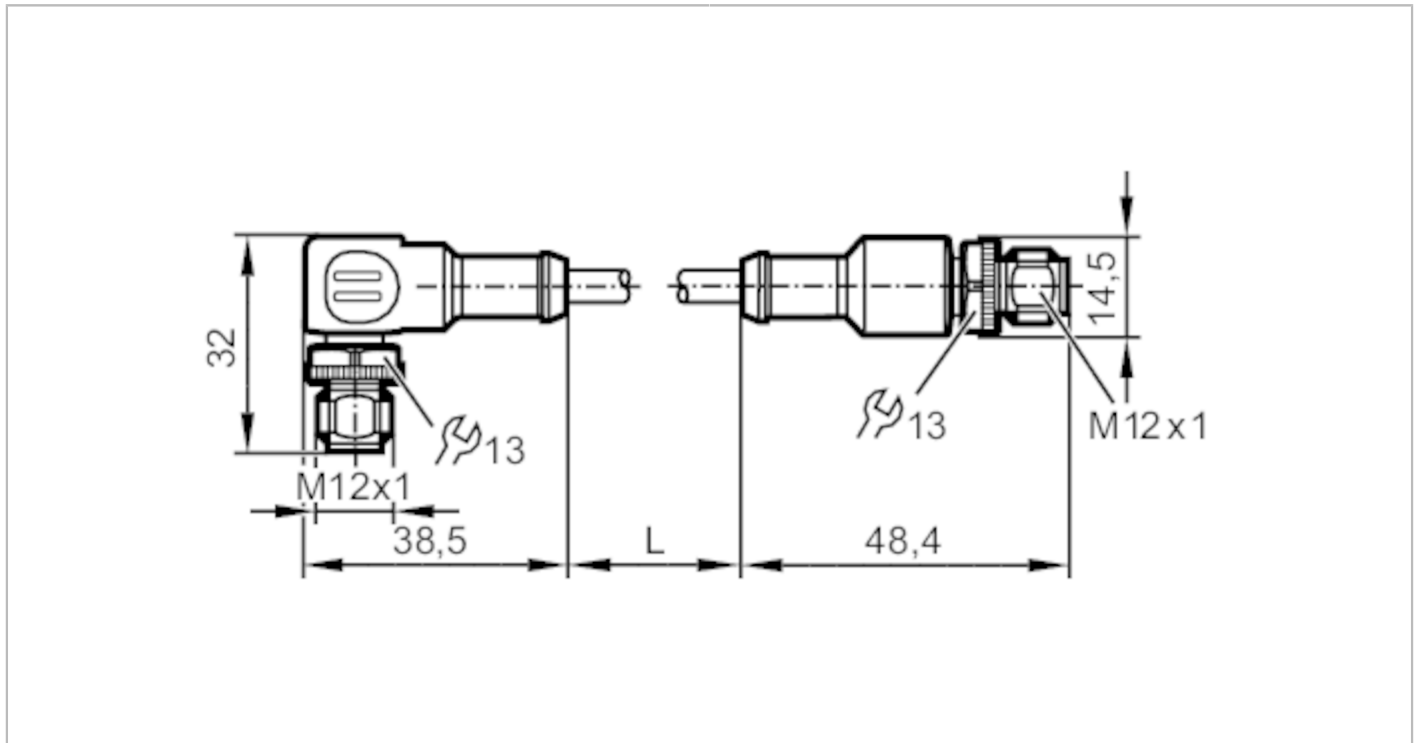

## Connection cable

CONNECTION CABLE M12 11M



Application	
Special feature	Screened cable; Drag chain suitability
Design	for 3D Smart sensor mobile with analogue video output PAL
Electrical data	
Operating voltage [V]	< 50 AC / < 60 DC
Protection class	III
Operating conditions	
Ambient temperature [°C]	-40...80
Protection	IP 67; IP 69K
Mechanical data	
Weight [g]	562.5
Materials	housing: PUR; Sealing: FKM; contact pins: CuSn6 nickel-plated and tin-plated
Material nut	stainless steel (1.4305 / 303) / stainless steel (1.4305 / 303)
Drag chain suitability	yes
Drag chain suitability	bending radius for fixed installation ≥ 60 mm
Remarks	
Pack quantity	1 pcs.
Electrical connection - plug	
Connector: 1 x M12, angled; Locking: stainless steel (1.4305 / 303)	

# E3M152



## Connection cable

CONNECTION CABLE M12 11M

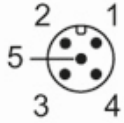

### Electrical connection

Cable: 11 m, black,  $\varnothing$  6 mm, shielded; 3 x 0.25 mm<sup>2</sup>

### Connection

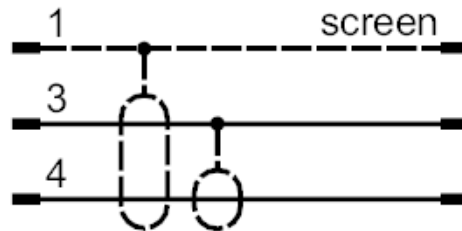

- |    |                 |
|----|-----------------|
| 1: | screen          |
| 2: | not used        |
| 3: | coax screen     |
| 4: | coax cable core |
| 5: | not used        |

### Electrical connection - plug

Connector: 1 x M12, straight; Locking: stainless steel (1.4305 / 303)

