

M8 female 0° with cable

PUR 8x0.14 5m

M8
Female straight
8-pole

Plastic housings with good resistance against chemicals and oils. The resistance to aggressive media should be individually tested for your application. Further details on request. Further cable lengths on request.

[Link to Product](#)**Illustration**

Female

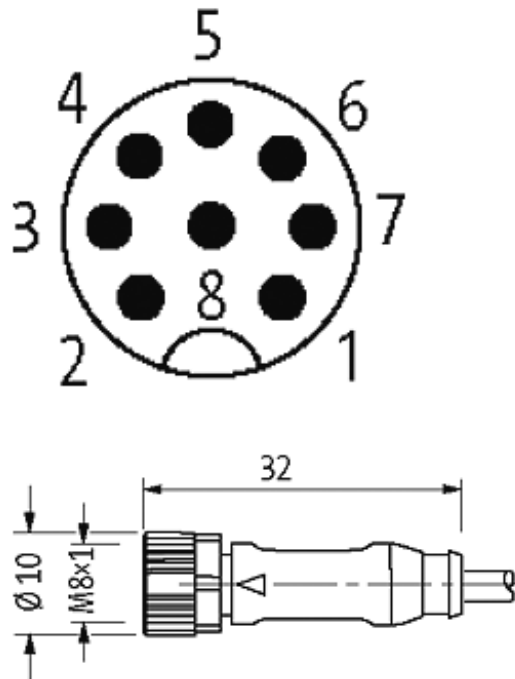

Product may differ from Image

Form

08961

Technical Data

Operating voltage	max. 30 V AC/DC
Operating current per contact	max. 1.5 A
Locking of ports	Screw thread M8 × 1 mm (recommended torque 0.4 Nm) self-securing
Protection	IP67 inserted and tightened (EN 60529)

Cables

Cable number	696
No./diameter of wires	8×0.14 mm ²
Wire isolation	PP (wh, br, gn, ye, gr, pk, bl, rd)
C-track properties	3 Mio.
Jacket Color	black
Shore hardness outer jacket	90 ± 5A
Material (jacket)	PUR (UL/CSA)
Outer diameter	approx. 6.0 mm
Bend radius (fixed)	5 × outer Ø
Bend radius (moving)	7.5 × outer Ø
Temperature range (fixed)	-30...+80 °C
Temperature range (mobile)	-30...+80 °C

Commercial data

country of origin	DE
customs tariff number	85369010
minimum order quantity	1