

2 x 2 connectors for profile cable

2 color LEDs per output,
state (yellow), overload (red) (optional)



(Figure similar)



Figure	Type	Inputs digital	Outputs digital	M12 connection (1)	Input voltage (sensor supply) (2)	Output voltage (actuator supply) (3)	AS-i connection (4)	AS-i address (5)	Max. output current	Art. no.
	IP67, 4 x M12	2	2 x electronic	Y	out of AS-i	out of AUX	AS-i profile cable	1 AB slave	1 A	BWU3456
	IP67, 4 x M12	2	2 x electronic, special AS-i bit assignment	Y	out of AS-i	out of AUX	AS-i profile cable	1 AB slave	1 A	BWU3449
	IP67, 4 x M12	2	2 x electronic	single	out of AS-i	out of AUX	AS-i profile cable	1 AB slave	1 A	BWU3141
	IP67, 4 x M12	4	–	Y	out of AS-i	–	AS-i profile cable	1 AB slave	–	BWU2552
	IP67, 4 x M12	4	–	Y	out of AS-i	–	AS-i via M12	1 AB slave	–	BWU3077
	IP67, 4 x M12	4	–	single	out of AS-i	–	AS-i profile cable	1 AB slave	–	BWU2620
	IP67, 4 x M12	4	–	single	out of AUX	–	AS-i profile cable	1 AB slave	–	BWU2725
	IP67, 4 x M12	4	2 x electronic	mixed	out of AUX	out of AUX	AS-i profile cable	1 AB slave	1 A	BWU2767
	IP67, 4 x M12	4	4 x electronic	mixed	out of AS-i	out of AS-i	AS-i profile cable	1 AB slave	120 mA	BWU3240
	IP67, 4 x M12	4	4 x electronic	mixed	out of AUX	out of AUX	AS-i profile cable	1 AB slave	500 mA	BWU2547
	IP67, 4 x M12	4	4 x electronic	Y	out of AS-i	out of AUX	AS-i profile cable	1 AB slave	500 mA	BWU2487
	IP67, 4 x M12	4	4 x electronic	Y	out of AUX	out of AUX	AS-i profile cable	1 AB slave	500 mA	BWU3032
	IP67, 4 x M12	4	3 x electronic	Y	out of AS-i	out of AUX	AS-i profile cable	1 AB slave	500 mA	BWU3375
	IP67, 4 x M12	–	4 x electronic	Y	–	out of AUX	AS-i profile cable	1 single slave	1 A	BWU2713
	IP67, 4 x M12	–	4 x electronic	Y	–	out of AUX	AS-i profile cable	1 AB slave	1 A	BWU2594
	IP67, 4 x M12	–	4 x electronic	Y	–	out of AUX, 2A per output	AS-i profile cable	1 AB slave	2 A	BWU2728

Figure	Type	Inputs digital	Outputs digital	M12 connection ⁽¹⁾	Input voltage (sensor supply) ⁽²⁾	Output voltage (actuator supply) ⁽³⁾	AS-i connection ⁽⁴⁾	AS-i address ⁽⁵⁾	Max. output current	Art. no.
	IP67, 8 x M12	4	3 x electronic	single	out of AS-i	out of AUX	AS-i profile cable	1 AB slave	2 A	BWU3496
	IP67, 8 x M12	4	4 x electronic	Y	out of AS-i	out of AUX	AS-i profile cable	1 AB slave	1 A	BWU2626
	IP67, 8 x M12	4	4 x electronic	single	out of AS-i	out of AUX	AS-i profile cable	1 AB slave	1A	BWU2617
	IP67, 8 x M12	4	4 x electronic	single	out of AS-i	out of AUX	AS-i profile cable	1 single slave	1 A	BWU2684
	IP67, 8 x M12	4	4 x electronic	single	out of AUX	out of AUX	AS-i profile cable	1 AB slave	1 A	BWU2810
	IP67, 8 x M12	4	4 x electronic	single	out of AUX	out of AUX	AS-i using M12	1 AB slave	1 A	BWU2645
	IP67, 8 x M12	8	–	Y	out of AUX	–	AS-i profile cable	2 AB slaves	–	BWU2770
	IP67, 8 x M12	8	–	Y	out of AS-i	–	AS-i profile cable	2 AB slaves	–	BWU2651
	IP67, 8 x M12	8	–	single	out of AS-i	–	AS-i profile cable	2 AB slaves	–	BWU2983
	IP67, 8 x M12	8	8 x electronic	Y	out of AS-i	out of AUX	AS-i profile cable	2 AB slaves	1 A	BWU2619
	IP67, 8 x M12	–	8 x electronic	Y	–	out of AUX	AS-i profile cable	2 AB slaves	1 A	BWU2652

Replacement, AS-i Version 2.0: single slaves (digital) are also working with the first generation AS-i masters.

⁽¹⁾ **M12 wiring:** either as a single-wiring, Y-wiring or mixed-wiring.

Single-wiring

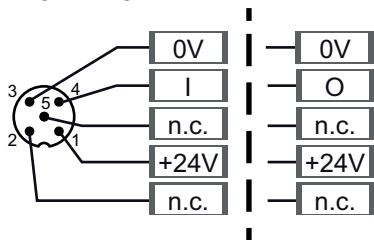

Y-wiring

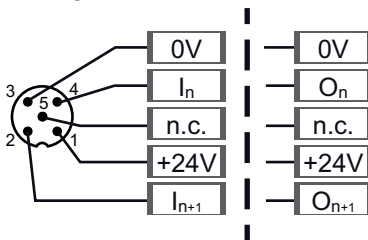

Mixed-wiring

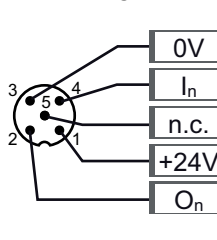

⁽²⁾ **Input voltage (sensor supply):** inputs are supplied by AS-i or by AUX (auxiliary 24 V power). If supplied by AS-i, inputs shall not be connected to earth or to external potential.

⁽³⁾ **Output voltage (actuator supply):** outputs are supplied by AS-i or by AUX (auxiliary 24 V power). If supplied by AS-i, outputs shall not be connected to earth or to external potential

⁽⁴⁾ **AS-i connection:** the connection to AS-i as well to AUX (auxiliary 24 V power) is made via yellow resp. black AS-i profile cable with piercing technology or via M12 socket (in IP20 via clamps).

⁽⁵⁾ **AS-i address:** 1 AB Slave (max. 62 AB Slaves/AS-i network), 2 AB Slaves (max. 31 modules with 2 AB Slaves), Single Slaves (max. 31 Single Slaves/AS-i network), mixed use allowed.

For modules with two slaves the second slave is turned off as long as the first slave is addressed to address "0". Upon request, slaves are available with specific AS-i Slave profiles.

Article No.	BWU2552	BWU3077	BWU2620	BWU2725
General data				
Device type	input			
Connection				
AS-i/AUX connection	profile cable and piercing	M12	profile cable and piercing	
Periphery connection	M12, Y-wiring		M12, single-wiring	
Length of connector cable	unlimited ⁽¹⁾			
AS-i				
Profile	S-0.A.E (ID1=7 default)			
Address	1 AB slave			
Required Master profile	≥M3			
As of AS-i specification	2.1			
Operating voltage	30 V (18 ... 31.6 V)			
Max. current consumption	165 mA		45 mA	
Max. current consumption without sensor/ actuator supply	45 mA			
AUX				
Operating voltage	-		24 V (18 ... 30 V)	
Max. current consumption	-		1 A	
Input				
Number	4			
Power supply	out of AS-i		out of AUX	
Power supply of attached sensors	up to +40 °C	120 mA ⁽²⁾		max. 1 A
	at +55 °C	100 mA ⁽²⁾		
	at +70 °C	80 mA ⁽²⁾		
Switching threshold	U < 5 V (low) U > 15 V (high)			
Display				
LED ASI (green)	on: AS-i voltage on flashing: AS-i voltage on, but peripheral fault ⁽³⁾ or address 0 off: no AS-i voltage			
LED FLT/FAULT (red)	on: slave address 0 or slave offline flashing: peripheral fault ⁽³⁾ off: slave online			
LED AUX (green)	-		on: 24 V _{DC} AUX off: no 24 V _{DC} AUX	
LEDs I1 ... In (yellow)	state of inputs I1 ... I4			
Environment				
Applied standards	EN 61000-2 EN 61000-3 EN 61131-2 EN 60529			
Operating altitude	max. 2000 m			
Ambient temperature	-30 °C ... +55 °C (up to max. +70 °C) ⁽²⁾ ⁽⁴⁾			
Storage temperature	-25 °C ... +85 °C			
Housing	plastic, for DIN rail mounting	plastic, for screw mounting	plastic, for DIN rail mounting	
Protection category	IP67			
Max. tolerable shock load	30g, 11 ms, acc. EN 61131-2			
Max. tolerable vibration stress	5 ... 8 Hz 50 mm _{pp} /8 ... 500 Hz 6g, acc. EN 61131-2			
Insulation voltage	≥500 V			
Weight	100 g			
Dimensions (W / H / D) in mm	45 / 80 / 42	45 / 116,5 / 47,5	45 / 80 / 42	

⁽¹⁾ Loop resistance ≤150 Ω

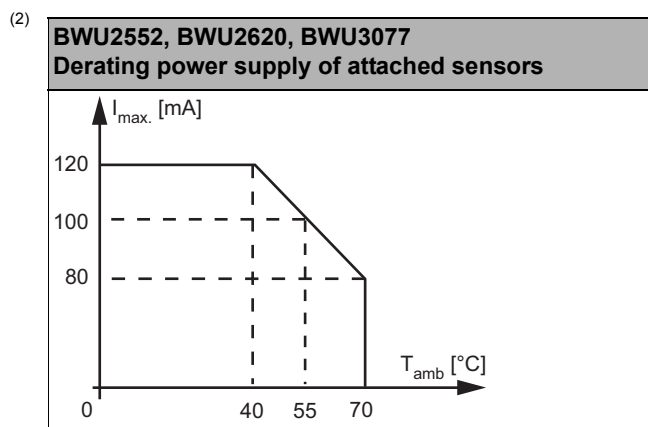

(3) See table "Peripheral fault indication"

(4) Maximum ambient operating temperature +55 °C according UL certificate for the use in the USA and Canada

Article No.	BWU2770	BWU2651	BWU2983
General data			
Device type	input		
Connection			
AS-i/AUX connection	profile cable and piercing		
Periphery connection	M12, Y-wiring		M12, single-wiring
Length of connector cable	unlimited ⁽¹⁾		
AS-i			
Profile	slave 1: S-0.A.E (ID1=7 default), slave 2: S-0.A.E (ID1=6 default)		
Address	2 AB slaves		
Required Master profile	≥M3		
As of AS-i specification	2.1		
Operating voltage	30 V (18 ... 31.6 V)		
Max. current consumption	60 mA		270 mA
Max. current consumption without sensor/ actuator supply	60 mA		70 mA
AUX			
Operating voltage	24 V (18 ... 30 V)		–
Max. current consumption	3 A		–
Input			
Number	4		
Power supply	out of AUX		out of AS-i
Power supply of attached sensors	up to +40 °C	max. 1 A	200 mA ⁽³⁾
	at +55 °C		150 mA ⁽²⁾
	at +70 °C		100 mA ⁽²⁾
Switching threshold	U<5 V (low) U>15 V (high)		

Article No.	BWU2770	BWU2651	BWU2983
Display			
LED ASI/FLT 1 (red/green)	green: slave online red: slave offline yellow/red flashing: address 0 red/green flashing: peripheral fault ⁽³⁾		
LED ASI/FLT 2 (red/green)	green: slave online red: slave offline yellow/red flashing: address 0 red/green flashing: peripheral fault ⁽³⁾ red flashing: slave 2 is switched off, because slave 1 is offline		
LED AUX (green)	on: 24 V _{DC} AUX off: no 24 V _{DC} AUX	-	
LEDs I1 ... In (yellow)	state of inputs I1 ... I8		
Environment			
Applied standards	EN 61000-2 EN 61000-3 EN 61131-2 EN 60529		
Operating altitude	max. 2000 m		
Ambient temperature	-30 °C ... +55 °C (up to max. +70 °C) ⁽²⁾ ⁽³⁾		
Storage temperature	-25 °C ... +85 °C		
Housing	plastic, for screw mounting		
Protection category	IP67		
Max. tolerable shock load	30g, 11 ms, acc. EN 61131-2		
Max. tolerable vibration stress	5 ... 8 Hz 50 mm _{pp} /8 ... 500 Hz 6g, acc. EN 61131-2		
Insulation voltage	≥500 V		
Weight	200 g		
Dimensions (W / H / D) in mm	60 / 151 / 31		

⁽¹⁾ Loop resistance ≤150 Ω

⁽²⁾ Maximum ambient operating temperature +55 °C according UL certificate for the use in the USA and Canada

⁽³⁾

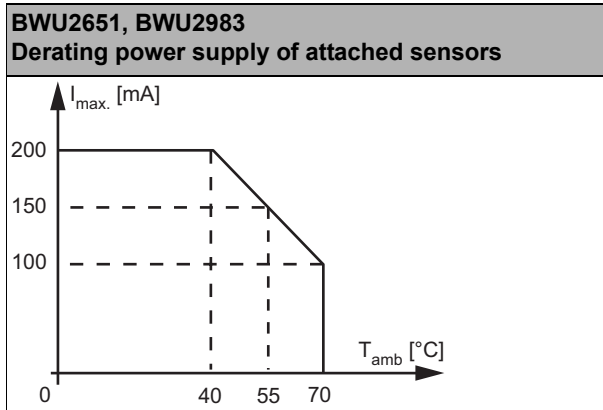

Article No.	BWU3456	BWU3449	BWU3141	BWU2767	BWU2547	BWU3240
General data						
Device type	input / output					
Connection						
AS-i/AUX Connection	profile cable and piercing					
Periphery connection	M12, Y-wiring	M12, single-wiring	M12, mixed- wiring			
Length of connector cable	unlimited ⁽¹⁾					
AS-i						
Profile	S-7.A.7 (ID1=7 fixed)		S-7.A.E (ID1=7 default)		S-7.A.7 (ID1=7 fixed)	
Address	1 AB slave					
Required Master profile	≥M4					
As of AS-i specification	3.0					
Operating voltage	30 V (18 ... 31.6 V)					
Max. current consumption	165 mA		35 mA		165 mA	
Max. current consumption without sensor/ actuator supply	45 mA		35 mA		45 mA	
AUX						
Operating voltage	24 V (18 ... 30 V)				-	
Max. current consumption	2 A		3 A		-	
Input						
Number	2		4			
Power supply	out of AS-i		out of AUX		out of AS-i	
Power supply of attached sensors	up to +40 °C	120 mA ⁽²⁾		max. 1 A		120 mA ⁽²⁾ Σ (In/Out) max. 120 mA
	at +55 °C	90 mA ⁽²⁾				90 mA ⁽²⁾
	at +70 °C	60 mA ⁽²⁾				60 mA ⁽²⁾
Switching threshold	U < 5 V (low) U > 15 V (high)					
Output						
Number	2		4			
Power supply	out of AUX					out of AS-i
Max. output current	up to +40 °C	1 A per output Σ(Out) 2 A ⁽³⁾		1 A		500 mA per output Σ(Out) 2 A ⁽⁸⁾ 120 mA ⁽²⁾ Σ (In/Out)
	at +55 °C	1 A per output Σ(Out) 1,5 A ⁽³⁾				500 mA per output Σ(Out) 1,5 A ⁽⁸⁾ 90 mA ⁽²⁾ Σ (In/Out)
	at +70 °C	1 A per output Σ(Out) 1 A ⁽³⁾				500 mA per output Σ(Out) 1 A ⁽⁸⁾ 60 mA ⁽²⁾ Σ (In/Out)

Article No.	BWU3456	BWU3449	BWU3141	BWU2767	BWU2547	BWU3240
Display						
LED ASI (green)	on: AS-i voltage on flashing: AS-i voltage on, but peripheral fault ⁽⁴⁾ or address 0 off: no AS-i voltage					
LED FLT/FAULT (red)	on: slave address 0 or slave offline flashing: peripheral fault ⁽⁴⁾ off: slave online					
LED AUX (green)	on: 24 V _{DC} AUX off: no 24 V _{DC} AUX					–
LEDs I1, I2 (yellow)	state of inputs I1, I2				–	
LEDs O1 / O2 ... (yellow / red)	yellow: state of outputs O1, O2 red: overload	–	yellow: state of outputs O1, O2 red: overload	–		
LEDs O3 / O4 ... (yellow / red)	–	yellow: state of outputs O3, O4 red: overload	–	–		
LEDs I1 / O1 ... In / On (yellow)	–				state of inputs/outputs I1 / O1 ... I4 / O4 input or output is on ⁽⁷⁾	
Environment						
Applied standards	EN 61000-2 EN 61000-3 EN 61131-2 EN 60529					
Operating altitude	max. 2000 m					
Ambient temperature	-30 °C ... +55 °C ^{(2) (3) (5) (6) (8)} (up to max. +70 °C)					
Storage temperature	-25 °C ... +85 °C					
Housing	plastic, for DIN rail mounting					
Protection category	IP67					
Max. tolerable shock load	30g, 11 ms, acc. EN 61131-2					
Max. tolerable vibration stress	5 ... 8 Hz 50 mm _{pp} /8 ... 500 Hz 6g, acc. EN 61131-2					
Insulation voltage	≥500 V					
Weight	100 g					
Dimensions (W / H / D) in mm	45 / 80 / 42					

(1) Loop resistance ≤150 Ω

(2) **BWU3141, BWU3240, BWU3449, BWU3456**
Derating of power supply of attached sensors

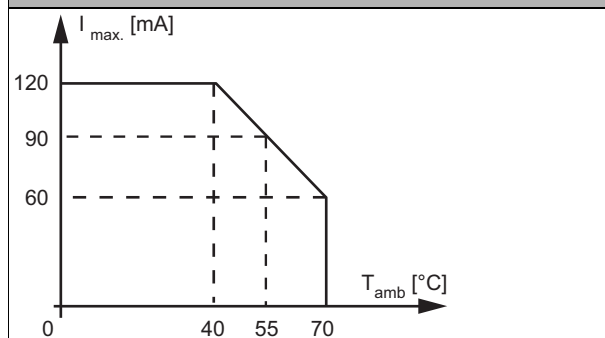

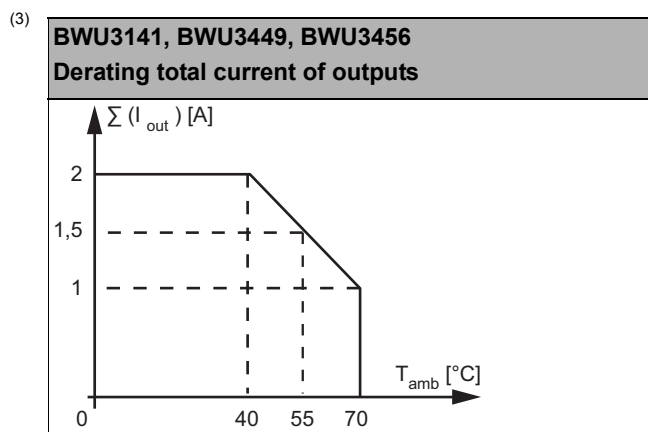

(4) See table "Peripheral fault indication"

(5) Temperature range up to -30°C from Ident.No. ≥16388 (BWU2767).

(6) Maximum ambient operating temperature +55 °C according UL certificate for the use in the USA and Canada

(7) **BWU2767**: LEDs I3/O3 and I4/O4 are indicating only the state of inputs I3 and I4 in accordance with the factual input/output assignment.

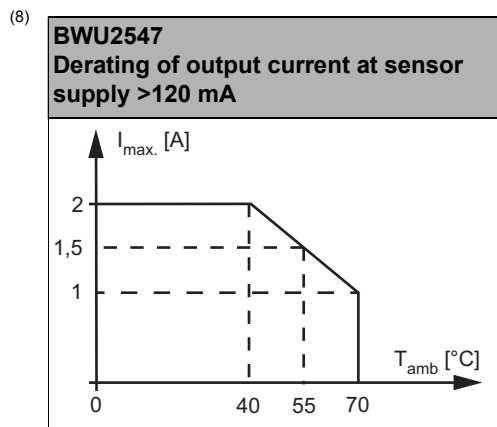

Article No.	BWU2487	BWU3032	BWU3375
General data			
Device type	input / output		
Connection			
AS-i/AUX Connection	profile cable and piercing		
Periphery connection	M12, Y-wiring		
Length of connector cable	unlimited ⁽¹⁾		
AS-i			
Profile	S-7.A.7 (ID1=7 fixed)		S-7.A.0 (ID1=7 default)
Address	1 AB slave		
Required Master profile	≥M4		≥M3
As of AS-i specification	3.0		2.1
Operating voltage	30 V (18 ... 31.6 V)		
Max. current consumption	165 mA	45 mA	165 mA
Max. current consumption without sensor/ actuator supply	45 mA		
AUX			
Operating voltage	24 V (18 ... 30 V)		
Max. current consumption	2 A		

Article No.	BWU2487		BWU3032	BWU3375
Input				
Number	4			
Power supply	out of AS-i	out of AUX		out of AS-i
Power supply of attached sensors	up to +40 °C	120 mA ⁽²⁾	1 A	120 mA ⁽²⁾
	at +55 °C	90 mA ⁽²⁾		90 mA ⁽²⁾
	at +70 °C	60 mA ⁽²⁾		60 mA ⁽²⁾
Switching threshold	U < 5 V (low) U > 15 V (high)			
Output				
Number	4		3	
Power supply	out of AUX			
Max. output current	up to +40 °C	500 mA per output		
	at +55 °C			
	at +70 °C			
Display				
LED ASI (green)	on: AS-i voltage on flashing: AS-i voltage on, but peripheral fault ⁽³⁾ or address 0 off: no AS-i voltage			
LED FLT/FAULT (red)	on: slave address 0 or slave offline flashing: peripheral fault ⁽⁴⁾ off: slave online			
LED AUX (green)	on: 24 V _{DC} AUX off: no 24 V _{DC} AUX			
LEDs I1 / I2 ... In / In+1 (yellow)	state of inputs I1 / I2 ... I3 / I4: at least 1 input of input pair is on			
LEDs O1 / O2 ... On / On+1 (yellow)	state of outputs O1 / O2 ... O3 / O4: at least 1 output of output pair is on		state of outputs O1 / O2 ... O3: at least 1 output of output pair is on	
Environment				
Applied standards	EN 61000-2 EN 61000-3 EN 61131-2 EN 60529			
Operating altitude	max. 2000 m			
Ambient temperature	-30 °C ... +55 °C ⁽²⁾ ⁽⁴⁾ ⁽⁵⁾ (up to max. +70 °C)			
Storage temperature	-25 °C ... +85 °C			
Housing	plastic, for DIN rail mounting			
Protection category	IP67			
Max. tolerable shock load	30g, 11 ms, acc. EN 61131-2			
Max. tolerable vibration stress	5 ... 8 Hz 50 mm _{pp} /8 ... 500 Hz 6g, acc. EN 61131-2			
Insulation voltage	≥ 500 V			
Weight	100 g			
Dimensions (W / H / D) in mm	45 / 80 / 42			

⁽¹⁾ Loop resistance ≤ 150 Ω

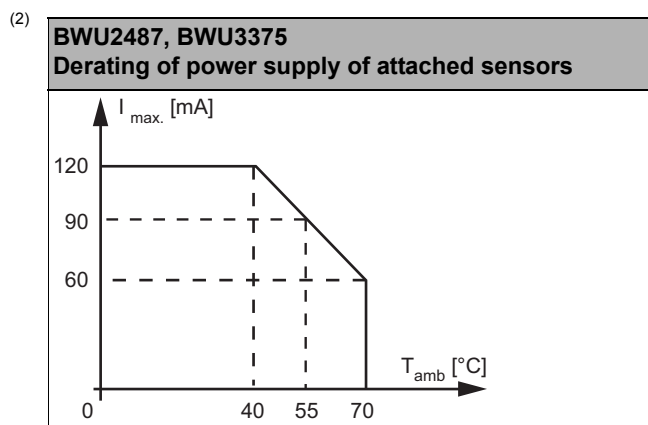

(3) See table "Peripheral fault indication"

(4) Temperature range up to -30°C from Ident.No. ≥16381 (BWU3032).

(5) Maximum ambient operating temperature +55 °C according UL certificate for the use in the USA and Canada

Article No.	BWU3496	BWU2626	BWU2617	BWU2684	BWU2810	BWU2645	
General data							
Device type	input / output						
Connection							
AS-i/AUX Connection	profile cable and piercing					M12	
Periphery connection	M12, single-wiring	M12, Y-wiring	M12, single-wiring				
Length of connector cable	unlimited ⁽¹⁾						
AS-i							
Profile	S-7.A.0 (ID1=7 default)	S-7.A.7 (ID1=7 fixed)		S-7.0.E (ID1=F default)	S-7.A.7 (ID1=7 fixed)		
Address	1 AB slave			1 single slave	1 AB slave		
Required Master profile	≥M30	≥M4		≥M0	≥M4		
As of AS-i specification	2.1	3.0		2.0	3.0		
Operating voltage	30 V (18 ... 31.6 V)						
Max. current consumption	165 mA				35 mA		
Max. current consumption without sensor/ actuator supply	45 mA				35 mA		
AUX							
Operating voltage	24 V (18 ... 30 V)						
Max. current consumption	6 A	3 A					
Input							
Number	4						
Power supply	out of AS-i				out of AUX		
Power supply of attached sensors	up to +40 °C	120 mA ⁽²⁾				max. 1 A	
	at +55 °C	100 mA ⁽²⁾					
	at +70 °C	80 mA ⁽²⁾					
Switching threshold	U<5 V (low) U>15 V (high)						

Article No.	BWU3496	BWU2626	BWU2617	BWU2684	BWU2810	BWU2645
Output						
Number	3		4			
Power supply	out of AUX					
Max. output current	up to +40 °C	2 A per output, Σ (Out) 6 A ⁽³⁾		1 A per output, Σ (Out) 3 A ⁽⁶⁾		
	at +55 °C	1,5 A per output, Σ (Out) 4,5 A ⁽³⁾				
	at +70 °C	1 A per output, Σ (Out) 3 A ⁽³⁾		1 A per output, Σ (Out) 2 A ⁽⁶⁾		
Display						
LED ASI (green)	on: AS-i voltage on flashing: AS-i voltage on, but peripheral fault ⁽⁴⁾ or address 0 off: no AS-i voltage					
LED FLT/FAULT (red)	on: slave address 0 or slave offline flashing: peripheral fault ⁽⁴⁾ off: slave online					
LED AUX (green)	on: 24 V _{DC} AUX off: no 24 V _{DC} AUX					
LEDs I1 ... In (yellow)	state of inputs I1 ... I4					
LEDs O1 ... On (yellow)	state of outputs O1 ... O3	-		state of outputs O1 ... O4	-	
LEDs O1 ... On (yellow / red)	-	yellow: state of outputs O1 ... O4 red: overload		-	yellow: state of outputs O1 ... O4 red: overload	
Environment						
Applied standards	EN 61000-2 EN 61000-3 EN 61131-2 EN 60529					
Operating altitude	max. 2000 m					
Ambient temperature	-30 °C ... +55 °C ⁽²⁾ ⁽³⁾ ⁽⁵⁾ ⁽⁶⁾ (up to max. +70 °C)					
Storage temperature	-30 °C ... +85 °C					
Housing	plastic, for screw mounting					
Protection category	IP67					
Max. tolerable shock load	30g, 11 ms, acc. EN 61131-2					
Max. tolerable vibration stress	5 ... 8 Hz 50 mm _{pp} /8 ... 500 Hz 6g, acc. EN 61131-2					
Insulation voltage	≥500 V					
Weight	200 g					
Dimensions (W / H / D) in mm	60 / 151 / 31					

(1) Loop resistance ≤150 Ω

(2) **BWU2617, BWU2626, BWU2684, BWU3496**
Derating of power supply of attached sensors

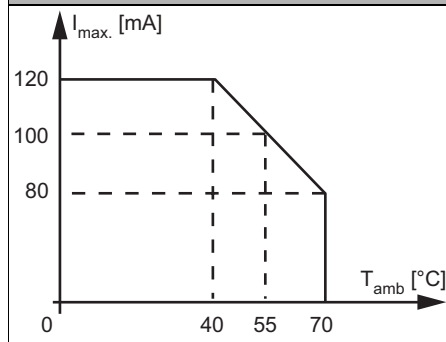

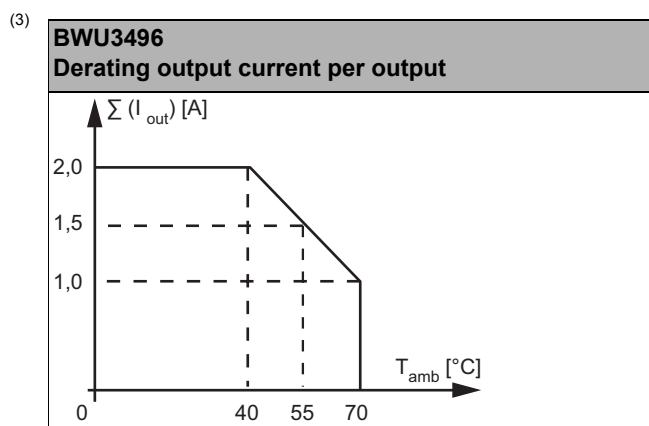

(4) See table "Peripheral fault indication"

(5) Maximum ambient operating temperature +55 °C according UL certificate for the use in the USA and Canada

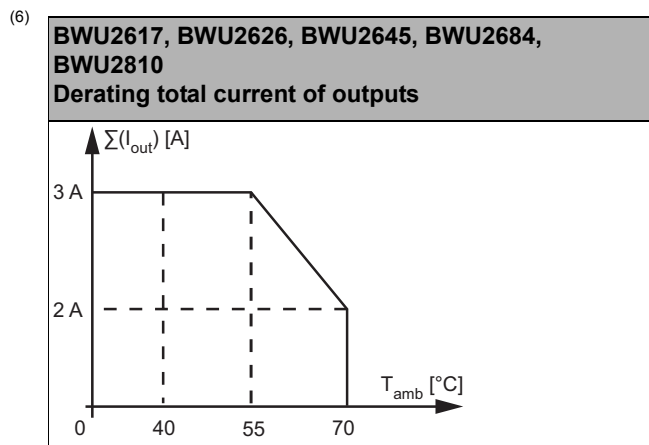

Article No.	BWU2619		BWU2652
General data			
Device type	input / output		output
Connection			
AS-i/AUX Connection	profile cable and piercing		
Periphery connection	M12, Y-wiring		
Length of connector cable	unlimited ⁽¹⁾		
AS-i			
Profile	slave 1: S-7.A.7 (ID1=7 fixed), slave 2: S-7.A.7 (ID1=6 default)		
Address	2 AB slaves		
Required Master profile	≥M4		
As of AS-i specification	3.0		
Operating voltage	30 V (18 ... 31.6 V)		
Max. current consumption	270 mA	60 mA	
Max. current consumption without sensor/ actuator supply	70 mA	60 mA	
AUX			
Operating voltage	24 V (18 ... 30 V)		
Max. current consumption	6 A		
Input			
Number	8		–
Power supply	out of AS-i		
Power supply of attached sensors	up to +40 °C	200 mA ⁽²⁾	–
	at +55 °C	150 mA ⁽²⁾	–
	at +70 °C	100 mA ⁽²⁾	–
Switching threshold	U < 5 V (low) U > 15 V (high)		–
Output			
Number	8		
Power supply	out of AUX		
Max. output current	up to +40 °C	1 A per output, $\sum(O1...O4) 3 A + \sum(O5...O8) 3 A$ ⁽³⁾	1 A per output, $\sum(O1...O4) 3 A + \sum(O5...O8) 3 A$ ⁽⁵⁾
	at +55 °C	1 A per output, $\sum(O1...O4) 1,625 A + \sum(O5...O8) 1,625 A$ ⁽³⁾	
	at +70 °C	0,25 A per output, $\sum(O1...O4) 0,25 A + \sum(O5...O8) 0,25 A$ ⁽³⁾	1 A per output, $\sum(O1...O4) 2 A + \sum(O5...O8) 2 A$ ⁽⁵⁾
Display			
LED ASI/FLT 1 (red/green)	green: slave online red: slave offline yellow/red flashing: address 0 red/green flashing: peripheral fault ⁽⁴⁾		
LED ASI/FLT 2 (red/green)	green: slave online red: slave offline yellow/red flashing: address 0 red/green flashing: peripheral fault ⁽⁴⁾ red flashing: slave 2 is switched off, because slave 1 is offline		
LED AUX (green)	on: 24 V _{DC} AUX off: no 24 V _{DC} AUX		
LEDs I1 / I2 ... In/In+1 (yellow)	state of inputs I1 / I2 ... I7 / I8: at least 1 input of input pair is on		–
LEDs O1 ... On (yellow / red)	–		yellow: state of outputs O1 ... O8 red: overload
LEDs O1/O2 ... On / On+1 (yellow)	state of outputs O1 / O2 ... O7 / O8: at least 1 output of output pair is on		–
Environment			

Article No.	BWU2619	BWU2652
Applied standards	EN 61000-2 EN 61000-3 EN 61131-2 EN 60529	
Operating altitude	max. 2000 m	
Ambient temperature	-30 °C ... +55 °C ⁽²⁾ ⁽³⁾ ⁽⁴⁾ ⁽⁵⁾ (up to max. +70 °C)	
Storage temperature	-30 °C ... +85 °C	
Housing	plastic, for screw mounting	
Protection category	IP67	
Max. tolerable shock load	30g, 11 ms, acc. EN 61131-2	
Max. tolerable vibration stress	5 ... 8 Hz 50 mm _{pp} /8 ... 500 Hz 6g, acc. EN 61131-2	
Insulation voltage	≥500 V	
Weight	200 g	
Dimensions (W / H / D) in mm	60 / 151 / 31	

(1) Loop resistance ≤150 Ω

(2)

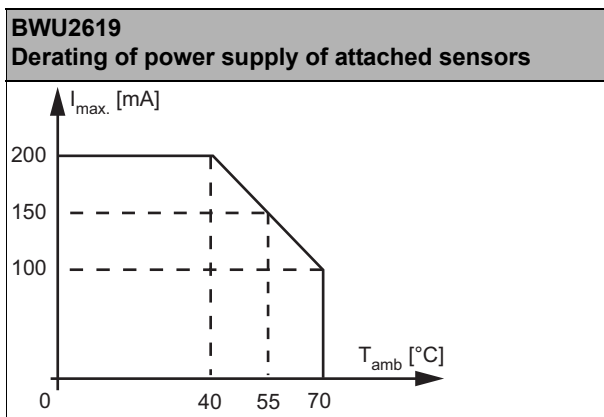

(3)

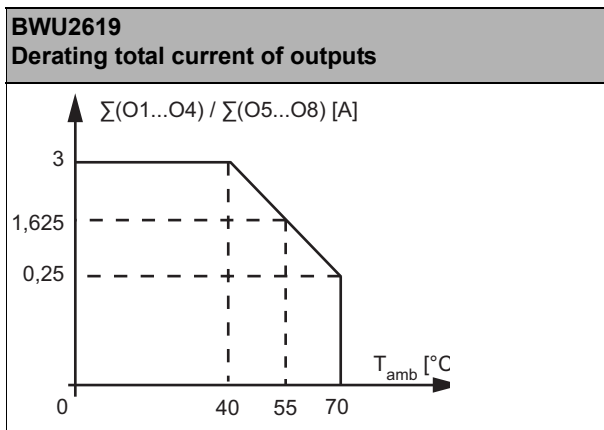

(4) Maximum ambient operating temperature +55 °C according UL certificate for the use in the USA and Canada

(5)

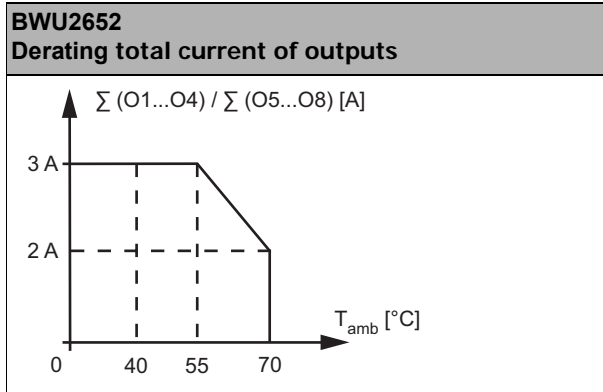

Article No.	BWU2713	BWU2594	BWU2728
General data			
Device type	output		
Connection			
AS-i/AUX Connection	profile cable and piercing		
Periphery connection	M12, Y-wiring		
Length of connector cable	unlimited ⁽¹⁾		
AS-i			
Profile	S-7.F.E (ID1=F default)	S-7.A.7 (ID1=7 fixed)	
Address	1 single slave	1 AB slave	
Required Master profile	≥M0	≥M4	
As of AS-i specification	2.0	3.0	
Operating voltage	30 V (18 ... 31.6 V)		
Max. current consumption	35 mA		
Max. current consumption without sensor/ actuator supply	35 mA		
AUX			
Operating voltage	24 V (18 ... 30 V)		
Max. current consumption	3 A	8 A	
Output			
Number	4		
Power supply	out of AUX		
Max. output current	up to +40 °C	1 A per output Σ (Out) 3 A ⁽²⁾	2 A per output, Σ (Out) 8 A ^{(5) (6)}
	at +55 °C		2 A per output, Σ (Out) 8 A ^{(5) (6)}
	at +70 °C	1 A per output Σ (Out) 2 A ⁽²⁾	–
Display			
LED ASI (green)	on: AS-i voltage on flashing: AS-i voltage on, but peripheral fault ⁽³⁾ or address 0 off: no AS-i voltage		
LED FLT/FAULT (red)	on: slave address 0 or slave offline flashing: peripheral fault ⁽³⁾ off: slave online		
LED AUX (green)	on: 24 V _{DC} AUX off: no 24 V _{DC} AUX		
LEDs O1 ... On (yellow /red)	yellow: state of outputs O1 ... O4 red: overload		

Article No.	BWU2713	BWU2594	BWU2728
Environment			
Applied standards	EN 61000-2 EN 61000-3 EN 61131-2 EN 60529		
Operating altitude	max. 2000 m		
Ambient temperature	-30 °C ... +55 °C (up to max. +70 °C) (2) (4) (5)		
Storage temperature	-30 °C ... +85 °C		
Housing	plastic, for DIN rail mounting		
Protection category	IP67		
Max. tolerable shock load	30g, 11 ms, acc. EN 61131-2		
Max. tolerable vibration stress	5 ... 8 Hz 50 mm _{pp} /8 ... 500 Hz 6g, acc. EN 61131-2		
Insulation voltage	≥500 V		
Weight	100 g		
Dimensions (W / H / D) in mm	45 / 80 / 42		

(1) Loop resistance ≤150 Ω

(2)

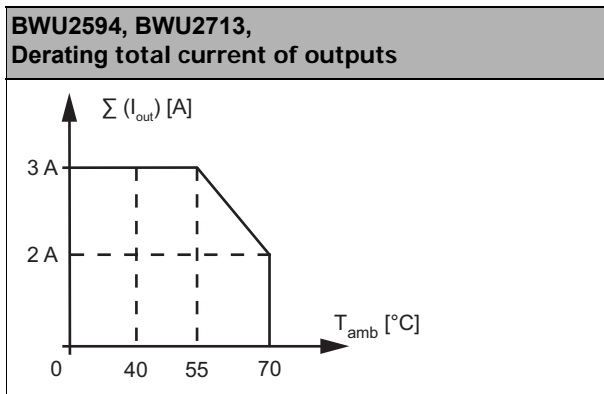

(3) See table "Peripheral fault indication"

(4) Maximum ambient operating temperature +55 °C according UL certificate for the use in the USA and Canada.

(5)

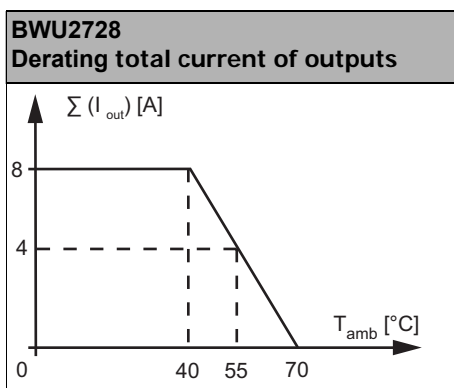

(6) To power consumers whose current draw is greater than 2A, two or more outputs can be combined with each other. The data bits of the bundled outputs must be set at the same time.

Article no.	Peripheral fault indication		
	Overload sensor supply	Output short circuited	AUX voltage missing
BWU2487	•	-	-
BWU2547	-	-	•
BWU2552	•	-	-
BWU2594	•	•	•
BWU2617	•	•	-
BWU2619	•	•	-
BWU2620	•	-	-
BWU2626	•	•	-
BWU2645	•	•	-
BWU2651	•	-	-
BWU2652	•	•	•
BWU2684	•	•	-
BWU2713	•	•	•
BWU2725	•	-	•
BWU2728	•	•	•
BWU2767	•	-	•
BWU2770	•	-	•
BWU2810	•	•	-
BWU2983	•	-	-
BWU3032	•	-	-
BWU3077	•	-	-
BWU3141	•	•	•
BWU3240	•	-	-
BWU3375	•	-	-
BWU3449	•	•	•
BWU3456	•	•	•
BWU3496	•	-	-

Programming	AS-i bit assignment			
	D0	D1	D2	D3
	input			
BWU2487 / BWU2547 / BWU2552 / BWU2617 / BWU2620 / BWU2626 / BWU2645 / BWU2684 / BWU2725 / BWU2767 / BWU2810 / BWU3032 / BWU3077 / BWU3240 / BWU3375 / BWU3496	I1	I2	I3	I4
BWU3141 / BWU3456 BWU3449	I1	I2	-	-
BWU2619 / BWU2651 / BWU2770 / BWU2983	slave 1: I1 slave 2: I5	slave 1: I2 slave 2: I6	slave 1: I3 slave 2: I7	slave 1: I4 slave 2: I8

Programming	AS-i bit assignment			
Bit	D0	D1	D2	D3
	output			
BWU2487 / BWU2547 / BWU2594 / BWU2617 / BWU2626 / BWU2645 / BWU2684 / BWU2713 / BWU2728 / BWU2767 / BWU2810 / BWU3032 / BWU3240	O1	O2	O3	O4
BWU3141 / BWU3456	O1	O2	–	–
BWU3449	–	–	O3	O4
BWU3375 / BWU3496	O1	O2	O3	–
BWU2619 / BWU2652	slave 1: O1	slave 1: O2	slave 1: O3	slave 1: O4
	slave 2: O5	slave 2: O6	slave 2: O7	slave 2: O8

Programming	Parameter bits			
Bit	P0	P1	P2	P3
BWU2652	not used, Watchdog always on	–	0= on / 1= off (synchronous I/O mode)	not used
BWU2594 / BWU2713	0= off / 1= on (Watchdog)	0= off / 1= on (peripheral fault, if AUX missing)		
BWU2728		0= on / 1= off (data input filter 128µs)		
BWU2487 / BWU2547 / BWU2617 / BWU2626 / BWU2645 / BWU2684 / BWU2767 / BWU2810 / BWU3032 / BWU3141 / BWU3240 / BWU3375 / BWU3456 / BWU3449 / BWU3496				
BWU2552 / BWU2620 / BWU2651 / BWU2725 / BWU2770 / BWU2983 / BWU3077	0= off / 1= on (peripheral fault)			
BWU2619	not used, Watchdog always on			

Pin assignment

Signal name	Explanation
I _x	digital input x
O _x	digital output x
24V _{ext out}	power supply, out of external voltage, positive pole (AUX, actuator supply)
0V _{ext out}	power supply, out of external voltage, negative pole (AUX, actuator supply)
24V _{out of AS-i}	power supply, out of AS-i, positive pole (sensor supply)
0V _{out of AS-i}	power supply, out of AS-i, negative pole (sensor supply)
AS-i+, AS-i-	connection to AS-i bus
n.c. (not connected)	not connected

Connections							
Article no.	M12 connection	Marking	Pin1	Pin2	Pin3	Pin4	Pin5
BWU3141	X1	I1	24 V _{out of AS-i}	n.c.	0 V _{out of AS-i}	I1	n.c.
	X2	O1	24 V _{ext out}	n.c.	0 V _{ext out}	O1	n.c.
	X3	I2	24 V _{out of AS-i}	n.c.	0 V _{out of AS-i}	I2	n.c.
	X4	O2	24 V _{ext out}	n.c.	0 V _{ext out}	O2	n.c.
	ADDR (dummy plug)	connection for AS-i addressing device					
BWU3456	X1	I1	24 V _{out of AS-i}	I2	0 V _{out of AS-i}	I1	n.c.
	X2	O1	24 V _{ext out}	O2	0 V _{ext out}	O1	n.c.
	X3	I2	24 V _{out of AS-i}	n.c.	0 V _{out of AS-i}	I2	n.c.
	X4	O2	24 V _{ext out}	n.c.	0 V _{ext out}	O2	n.c.
	ADDR (dummy plug)	connection for AS-i addressing device					
BWU3449	X1	I1	24 V _{out of AS-i}	I2	0 V _{out of AS-i}	I1	n.c.
	X2	O3	24 V _{ext out}	O4	0 V _{ext out}	O3	n.c.
	X3	I2	24 V _{out of AS-i}	n.c.	0 V _{out of AS-i}	I2	n.c.
	X4	O4	24 V _{ext out}	n.c.	0 V _{ext out}	O4	n.c.
	ADDR (dummy plug)	connection for AS-i addressing device					
BWU2487	X1	I1/I2	24 V _{out of AS-i}	I2	0 V _{out of AS-i}	I1	n.c.
	X2	O1/O2	24 V _{ext out}	O2	0 V _{ext out}	O1	n.c.
	X3	I3/I4	24 V _{out of AS-i}	I4	0 V _{out of AS-i}	I3	n.c.
	X4	O3/O4	24 V _{ext out}	O4	0 V _{ext out}	O3	n.c.
	ADDR (dummy plug)	connection for AS-i addressing device					
BWU3032	X1	I1/I2	24 V _{ext out}	I2	0 V _{ext out}	I1	n.c.
	X2	O1/O2	24 V _{ext out}	O2	0 V _{ext out}	O1	n.c.
	X3	I3/I4	24 V _{ext out}	I4	0 V _{ext out}	I3	n.c.
	X4	O3/O4	24 V _{ext out}	O4	0 V _{ext out}	O3	n.c.
	ADDR (dummy plug)	connection for AS-i addressing device					
BWU3375	X1	I1/I2	24 V _{out of AS-i}	I2	0 V _{out of AS-i}	I1	n.c.
	X2	O1/O2	24 V _{ext out}	O2	0 V _{ext out}	O1	n.c.
	X3	I3/I4	24 V _{out of AS-i}	I4	0 V _{out of AS-i}	I3	n.c.
	X4	O3	24 V _{ext out}	n.c.	0 V _{ext out}	O3	n.c.
	ADDR (dummy plug)	connection for AS-i addressing device					
BWU2547	X1	I1/O1	24 V _{ext out}	O1	0 V _{ext out}	I1	n.c.
	X2	I2/O2	24 V _{ext out}	O2	0 V _{ext out}	I2	n.c.
	X3	I3/O3	24 V _{ext out}	O3	0 V _{ext out}	I3	n.c.
	X4	I4/O4	24 V _{ext out}	O4	0 V _{ext out}	I4	n.c.
	ADDR (dummy plug)	connection for AS-i addressing device					

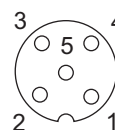
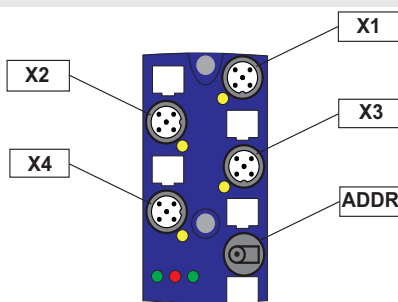

Connections							
Article no.	M12 connection	Marking	Pin1	Pin2	Pin3	Pin4	Pin5
BWU2767	X1	I1/O1	24 V _{ext out}	O1	0 V _{ext out}	I1	n.c.
	X2	I2/O2	24 V _{ext out}	O2	0 V _{ext out}	I2	n.c.
	X3	I3	24 V _{ext out}	n.c.	0 V _{ext out}	I3	n.c.
	X4	I4	24 V _{ext out}	n.c.	0 V _{ext out}	I4	n.c.
	ADDR (dummy plug)	connection for AS-i addressing device					
BWU2594 BWU2713 BWU2728	X1	O1	0 V _{ext out}	O2	0 V _{ext out}	O1	n.c.
	X2	O2	0 V _{ext out}	n.c.	0 V _{ext out}	O2	n.c.
	X3	O3	0 V _{ext out}	O4	0 V _{ext out}	O3	n.c.
	X4	O4	0 V _{ext out}	n.c.	0 V _{ext out}	O4	n.c.
	ADDR (dummy plug)	connection for AS-i addressing device					
BWU2552	X1	I1	24 V _{out of AS-i}	I2	0 V _{out of AS-i}	I1	n.c.
	X2	I2	24 V _{out of AS-i}	n.c.	0 V _{out of AS-i}	I2	n.c.
	X3	I3	24 V _{out of AS-i}	I4	0 V _{out of AS-i}	I3	n.c.
	X4	I4	24 V _{out of AS-i}	n.c.	0 V _{out of AS-i}	I4	n.c.
	ADDR (dummy plug)	connection for AS-i addressing device					
BWU2620	X1	I1	24 V _{out of AS-i}	n.c.	0 V _{out of AS-i}	I1	n.c.
	X2	I2	24 V _{out of AS-i}	n.c.	0 V _{out of AS-i}	I2	n.c.
	X3	I3	24 V _{out of AS-i}	n.c.	0 V _{out of AS-i}	I3	n.c.
	X4	I4	24 V _{out of AS-i}	n.c.	0 V _{out of AS-i}	I4	n.c.
	ADDR (dummy plug)	connection for AS-i addressing device					
BWU2725	X1	I1	24 V _{ext out}	n.c.	0 V _{ext out}	I1	n.c.
	X2	I2	24 V _{ext out}	n.c.	0 V _{ext out}	I2	n.c.
	X3	I3	24 V _{ext out}	n.c.	0 V _{ext out}	I3	n.c.
	X4	I4	24 V _{ext out}	n.c.	0 V _{ext out}	I4	n.c.
	ADDR (dummy plug)	connection for AS-i addressing device					
BWU3077	X1	I1	24 V _{out of AS-i}	I2	0 V _{out of AS-i}	I1	n.c.
	X2	I2	24 V _{out of AS-i}	n.c.	0 V _{out of AS-i}	I2	n.c.
	X3	I3	24 V _{out of AS-i}	I4	0 V _{out of AS-i}	I3	n.c.
	X4	I4	24 V _{out of AS-i}	n.c.	0 V _{out of AS-i}	I4	n.c.
	X5	AS-i	AS-i+	n.c.	AS-i-	n.c.	-
BWU3240	X1	I1/O1	24 V _{out of AS-i}	O1	0 V _{out of AS-i}	I1	n.c.
	X2	I2/O2	24 V _{out of AS-i}	O2	0 V _{out of AS-i}	I2	n.c.
	X3	I3/O3	24 V _{out of AS-i}	O3	0 V _{out of AS-i}	I3	n.c.
	X4	I4/O4	24 V _{out of AS-i}	O4	0 V _{out of AS-i}	I4	n.c.
	ADDR (dummy plug)	connection for AS-i addressing device					

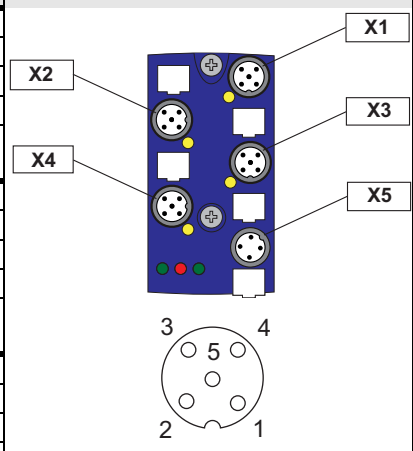

Connections							
Article no.	M12 connection	Marking	Pin1	Pin2	Pin3	Pin4	Pin5
BWU2617 BWU2684	X1	I1	24 V _{out} of AS-i	n.c.	0 V _{out} of AS-i	I1	n.c.
	X2	I2	24 V _{out} of AS-i	n.c.	0 V _{out} of AS-i	I2	n.c.
	X3	I3	24 V _{out} of AS-i	n.c.	0 V _{out} of AS-i	I3	n.c.
	X4	I4	24 V _{out} of AS-i	n.c.	0 V _{out} of AS-i	I4	n.c.
	X5	O1	0 V _{ext} out	n.c.	0 V _{ext} out	O1	n.c.
	X6	O2	0 V _{ext} out	n.c.	0 V _{ext} out	O2	n.c.
	X7	O3	0 V _{ext} out	n.c.	0 V _{ext} out	O3	n.c.
	X8	O4	0 V _{ext} out	n.c.	0 V _{ext} out	O4	n.c.
ADDR (dummy plug)	connection for AS-i addressing device						
BWU2619	X1	I1/I2	24 V _{out} of AS-i	I2	0 V _{out} of AS-i	I1	n.c.
	X2	I3/I4	24 V _{out} of AS-i	I4	0 V _{out} of AS-i	I3	n.c.
	X3	I5/I6	24 V _{out} of AS-i	I6	0 V _{out} of AS-i	I5	n.c.
	X4	I7/I8	24 V _{out} of AS-i	I8	0 V _{out} of AS-i	I7	n.c.
	X5	O1/O2	0 V _{ext} out	O2	0 V _{ext} out	O1	n.c.
	X6	O3/O4	0 V _{ext} out	O4	0 V _{ext} out	O3	n.c.
	X7	O5/O6	0 V _{ext} out	O6	0 V _{ext} out	O5	n.c.
	X8	O7/O8	0 V _{ext} out	O8	0 V _{ext} out	O7	n.c.
ADDR (dummy plug)	connection for AS-i addressing device						
BWU2626	X1	I1	24 V _{out} of AS-i	I2	0 V _{out} of AS-i	I1	n.c.
	X2	I2	24 V _{out} of AS-i	n.c.	0 V _{out} of AS-i	I2	n.c.
	X3	I3	24 V _{out} of AS-i	I4	0 V _{out} of AS-i	I3	n.c.
	X4	I4	24 V _{out} of AS-i	n.c.	0 V _{out} of AS-i	I4	n.c.
	X5	O1	0 V _{ext} out	O2	0 V _{ext} out	O1	n.c.
	X6	O2	0 V _{ext} out	n.c.	0 V _{ext} out	O2	n.c.
	X7	O3	0 V _{ext} out	O4	0 V _{ext} out	O3	n.c.
	X8	O4	0 V _{ext} out	n.c.	0 V _{ext} out	O4	n.c.
ADDR (dummy plug)	connection for AS-i addressing device						
BWU3496	X1	I1	24 V _{out} of AS-i	n.c.	0 V _{out} of AS-i	I1	n.c.
	X2	I2	24 V _{out} of AS-i	n.c.	0 V _{out} of AS-i	I2	n.c.
	X3	I3	24 V _{out} of AS-i	n.c.	0 V _{out} of AS-i	I3	n.c.
	X4	I4	24 V _{out} of AS-i	n.c.	0 V _{out} of AS-i	I4	n.c.
	X5	O1	0 V _{ext} out	n.c.	0 V _{ext} out	O1	n.c.
	X6	O2	0 V _{ext} out	n.c.	0 V _{ext} out	O2	n.c.
	X7	O3	0 V _{ext} out	n.c.	0 V _{ext} out	O3	n.c.
	X8	not used					
ADDR (dummy plug)	connection for AS-i addressing device						
BWU2651	X1	I1	24 V _{out} of AS-i	I2	0 V _{out} of AS-i	I1	n.c.
	X2	I2	24 V _{out} of AS-i	n.c.	0 V _{out} of AS-i	I2	n.c.
	X3	I3	24 V _{out} of AS-i	I4	0 V _{out} of AS-i	I3	n.c.
	X4	I4	24 V _{out} of AS-i	n.c.	0 V _{out} of AS-i	I4	n.c.
	X5	I5	24 V _{out} of AS-i	I6	0 V _{out} of AS-i	I5	n.c.
	X6	I6	24 V _{out} of AS-i	n.c.	0 V _{out} of AS-i	I6	n.c.
	X7	I7	24 V _{out} of AS-i	I8	0 V _{out} of AS-i	I7	n.c.
	X8	I8	24 V _{out} of AS-i	n.c.	0 V _{out} of AS-i	I8	n.c.
ADDR (dummy plug)	connection for AS-i addressing device						

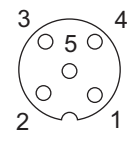
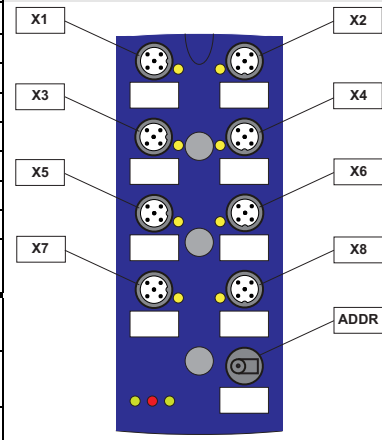

Connections							
Article no.	M12 connection	Marking	Pin1	Pin2	Pin3	Pin4	Pin5
BWU2983	X1	I1	24 V _{out} of AS-i	n.c.	0 V _{out} of AS-i	I1	n.c.
	X2	I2	24 V _{out} of AS-i	n.c.	0 V _{out} of AS-i	I2	n.c.
	X3	I3	24 V _{out} of AS-i	n.c.	0 V _{out} of AS-i	I3	n.c.
	X4	I4	24 V _{out} of AS-i	n.c.	0 V _{out} of AS-i	I4	n.c.
	X5	I5	24 V _{out} of AS-i	n.c.	0 V _{out} of AS-i	I5	n.c.
	X6	I6	24 V _{out} of AS-i	n.c.	0 V _{out} of AS-i	I6	n.c.
	X7	I7	24 V _{out} of AS-i	n.c.	0 V _{out} of AS-i	I7	n.c.
	X8	I8	24 V _{out} of AS-i	n.c.	0 V _{out} of AS-i	I8	n.c.
	ADDR (dummy plug)	connection for AS-i addressing device					
BWU2652	X1	O1	0 V _{ext out}	O2	0 V _{ext out}	O1	n.c.
	X2	O2	0 V _{ext out}	n.c.	0 V _{ext out}	O2	n.c.
	X3	O3	0 V _{ext out}	O4	0 V _{ext out}	O3	n.c.
	X4	O4	0 V _{ext out}	n.c.	0 V _{ext out}	O4	n.c.
	X5	O5	0 V _{ext out}	O6	0 V _{ext out}	O5	n.c.
	X6	O6	0 V _{ext out}	n.c.	0 V _{ext out}	O6	n.c.
	X7	O7	0 V _{ext out}	O8	0 V _{ext out}	O7	n.c.
	X8	O8	0 V _{ext out}	n.c.	0 V _{ext out}	O8	n.c.
	ADDR (dummy plug)	connection for AS-i addressing device					
BWU2770	X1	I1	24 V _{ext out}	I2	0 V _{ext out}	I1	n.c.
	X2	I2	24 V _{ext out}	n.c.	0 V _{ext out}	I2	n.c.
	X3	I3	24 V _{ext out}	I4	0 V _{ext out}	I3	n.c.
	X4	I4	24 V _{ext out}	n.c.	0 V _{ext out}	I4	n.c.
	X5	I5	24 V _{ext out}	I6	0 V _{ext out}	I5	n.c.
	X6	I6	24 V _{ext out}	n.c.	0 V _{ext out}	I6	n.c.
	X7	I7	24 V _{ext out}	I8	0 V _{ext out}	I7	n.c.
	X8	I8	24 V _{ext out}	n.c.	0 V _{ext out}	I8	n.c.
	ADDR (dummy plug)	connection for AS-i addressing device					

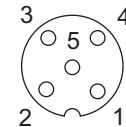
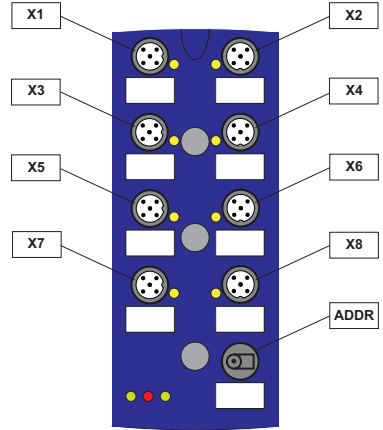

Connections							
Article no.	M12 connection	Marking	Pin1	Pin2	Pin3	Pin4	Pin5
BWU2810	X1	I1	24 V _{ext out}	n.c.	0 V _{ext out}	I1	n.c.
	X2	I2	24 V _{ext out}	n.c.	0 V _{ext out}	I2	n.c.
	X3	I3	24 V _{ext out}	n.c.	0 V _{ext out}	I3	n.c.
	X4	I4	24 V _{ext out}	n.c.	0 V _{ext out}	I4	n.c.
	X5	O1	0 V _{ext out}	n.c.	0 V _{ext out}	O1	n.c.
	X6	O2	0 V _{ext out}	n.c.	0 V _{ext out}	O2	n.c.
	X7	O3	0 V _{ext out}	n.c.	0 V _{ext out}	O3	n.c.
	X8	O4	0 V _{ext out}	n.c.	0 V _{ext out}	O4	n.c.
	ADDR (dummy plug)	connection for AS-i addressing device					
BWU2645	X1	I1	24 V _{ext out}	n.c.	0 V _{ext out}	I1	n.c.
	X2	I2	24 V _{ext out}	n.c.	0 V _{ext out}	I2	n.c.
	X3	I3	24 V _{ext out}	n.c.	0 V _{ext out}	I3	n.c.
	X4	I4	24 V _{ext out}	n.c.	0 V _{ext out}	I4	n.c.
	X5	O1	0 V _{ext out}	n.c.	0 V _{ext out}	O1	n.c.
	X6	O2	0 V _{ext out}	n.c.	0 V _{ext out}	O2	n.c.
	X7	O3	0 V _{ext out}	n.c.	0 V _{ext out}	O3	n.c.
	X8	O4	0 V _{ext out}	n.c.	0 V _{ext out}	O4	n.c.
	X9	AS-i	AS-i+	0 V _{ext in}	AS-i-	24 V _{ext in}	-

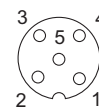
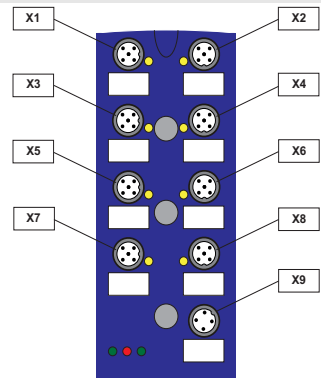

Mounting according to cable direction

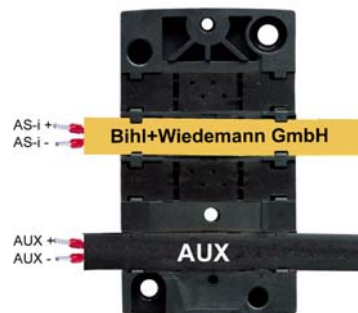

ordinary

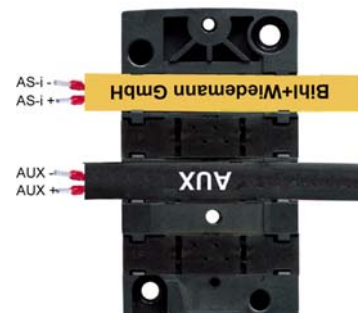

turned

Line termination with sealing profiles / as junction

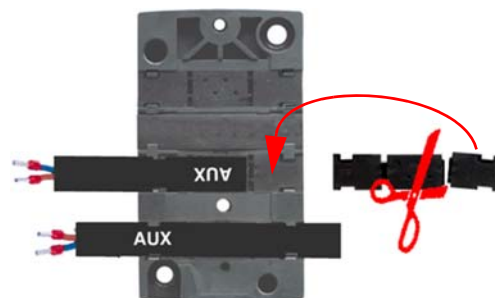
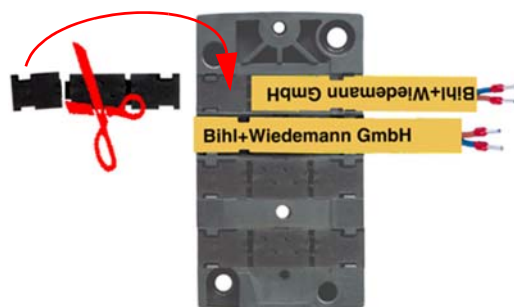

Accessories:

- AS-i substructure module for 4 channel module in 45 mm housing (art. no. BW2349)
- AS-i substructure module (CNOMO) for 4 channel module in 45 mm housing (art. no. BW2350)
- AS-i substructure module (CNOMO) for 8 channel module in 60 mm housing (art. no. BW2351)
- Protection caps for unused M12 sockets (art. no. BW2368)
- Sealing profile IP67 (IDC plug), 60 mm (art. no. BW3282)
- Sealing profile IP67 (IDC plug), 45 mm (art. no. BW3283)