

# SCP2.5 - Spring Clamp Terminal with Plug Entry

SCP Series - 500V, 24A, 2.5mm<sup>2</sup>

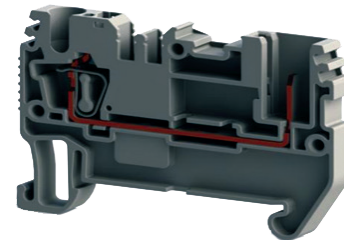

Dimensions & Weight			
Width	5.20mm		
Height (MR35x7.5)	37.30mm		
Length	51.60mm		
Net Weight	6g		
Electrical Ratings	Voltage V~	Current A	Cross-Section
UL	-	-	-
IEC	500V	24A	0.5-4mm <sup>2</sup>
IECEX	-	-	-
Flammability Rating			
UL94	V0		
Temperature			
Operating Temperature	-60°C to +130°C		
Connection Data			
Conductor Cross-Section Solid (min-max)	0.08-4mm <sup>2</sup>		
Conductor Cross-Section Stranded (min-max)	0.2-2.5mm <sup>2</sup>		
Conductor Cross-Section Stranded with Ferrules (min-max)	0.14-2.5mm <sup>2</sup>		
2 Conductors with same Cross-Section Stranded, Twin Ferrules with plastic sleeve	0.5mm <sup>2</sup>		
AWG Conductor	AWG 28-12		
Insulation Stripping Length (min-max)	8-10mm		
Connection in Acc. with Standard	IEC 60947-7-1		
Torque (min-max)	N/A		
Technical Data			
Rated Surge Voltage / Pollution Degree	6kV / 3		
Protection Class / Protection Conductor Type	IP0 / -		

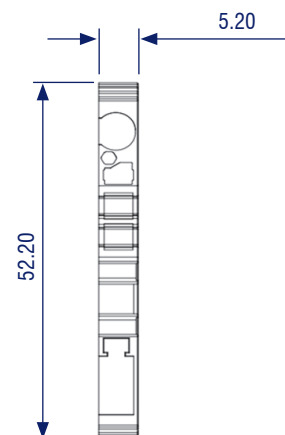
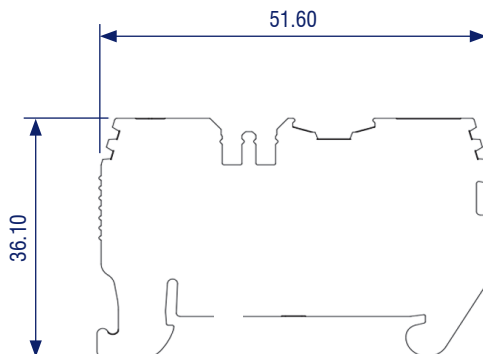

NOTE: Dimensions above are in mm

# SCP2.5 - Spring Clamp Terminal with Plug Entry

SCP Series - 500V, 24A, 2.5mm<sup>2</sup>



Ordering Codes		<i>(please refer to IMO for availability)</i>	
■ GREY	SCP2.5GREY	■ GREEN	SCP2.5GREEN
■ RED	SCP2.5RED*	■ YELLOW	SCP2.5YELLOW*
■ BLACK	SCP2.5BLACK*	□ WHITE	SCP2.5WHITE*
■ BLUE	SCP2.5BLUE*	■ ORANGE	SCP2.5ORANGE*
Pack Size			
Quantity	50 Pcs		

### Accessories

End Plates	Part Number	Part Number	
■ GREY	SCPEP2.5GREY	■ GREEN	SCPEP2.5GREEN
■ RED	SCPEP2.5RED*	■ YELLOW	SCPEP2.5YELLOW*
■ BLACK	SCPEP2.5BLACK*	□ WHITE	SCPEP2.5WHITE*
■ BLUE	SCPEP2.5BLUE*	■ ORANGE	SCPEP2.5ORANGE*

Partition	Part Number
	SP1GREY (small partition plate)
<i>Product shown: SP2.5-10BEIGE</i>	SP2.5-10GREY (large partition plate)

Cross Connection	Part Number
	CCS2.5/2 (2 way)
<i>Product shown: CCS2.5/3</i>	CCS2.5/3 (3 way)
	CCS2.5/4 (4 way)
	CCS2.5/10 (10 way)

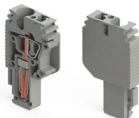
Plug Connectors	Part Number
	SCP-PT2.5/1GREY
<i>Product shown: SCP-PT2.5/1GREY</i>	SCP-PT2.5/1LGREY
	SCP-PT2.5/1MGREY
	SCP-PT2.5/1RGREY

Markers	Part Number
Blank Marker (white 5x5mm)	Contact IMO for further information

End Brackets	Part Number
Part Number: ES1 <i>Screw type for MR35 DIN Rail</i>	Part Number: ES4GREY <i>Screwless for MR35 DIN Rail</i>

Socket Lock	Socket Lock
Part Number: SCP-LOCK1 <i>Enables locking of plug to socket. Manual operation required to remove plug.</i>	Part Number: SCP-LOCK2 <i>Enables locking of two plugs to socket. Manual operation required to remove plug.</i>

Pin Coding	Cable Holder
Part Number: SCP-CODE <i>Enables blocking of terminal to prevent plug mis-connection</i>	Part Number: SCP-HOLD <i>Enables secure attachment of cables to terminals</i>



SCP2.5GREY

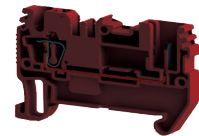

SCP2.5RED



SCP2.5BLACK

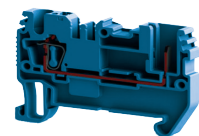

SCP2.5BLUE

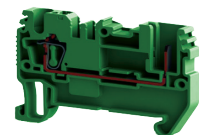

SCP2.5GREEN

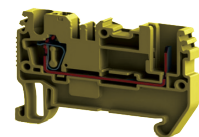

SCP2.5YELLOW

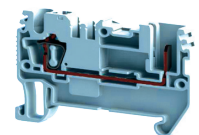

SCP2.5WHITE

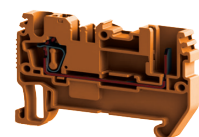

SCP2.5ORANGE

\* Supplied in grey & green as standard. For all other colours, minimum order quantities apply. Contact IMO for details.

NOTE: Images for illustration purposes only

# SCP-HM2.5 - Hole Mounting Terminal

SCP Series - 500V, 24A, 2.5mm<sup>2</sup> - Single Pole Modular

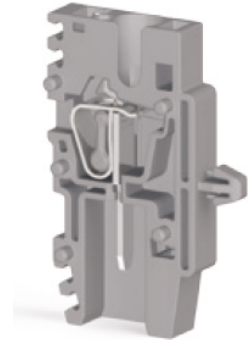
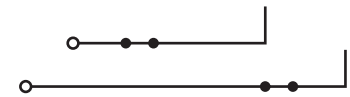

Dimensions & Weight			
Width	5.20mm		
Height (MR35x7.5)	35.00mm		
Length	16.90mm		
Net Weight	4.5g		
Electrical Ratings	Voltage V~	Current A	Cross-Section
UL	-	-	-
IEC	500V	24A	0.5-4mm <sup>2</sup>
IECEX	-	-	-
Flammability Rating			
UL94	V0		
Temperature			
Operating Temperature	-60°C to +130°C		
Connection Data			
Conductor Cross-Section Solid (min-max)	0.08-4mm <sup>2</sup>		
Conductor Cross-Section Stranded (min-max)	0.2-2.5mm <sup>2</sup>		
Conductor Cross-Section Stranded with Ferrules (min-max)	0.14-2.5mm <sup>2</sup>		
2 Conductors with same Cross-Section Stranded, Twin Ferrules with plastic sleeve	0.5mm <sup>2</sup>		
AWG Conductor	AWG 28-12		
Insulation Stripping Length (min-max)	8-10mm		
Connection in Acc. with Standard	IEC 60947-7-1		
Torque (min-max)	N/A		
Technical Data			
Rated Surge Voltage / Pollution Degree	6kV / 3		
Protection Class / Protection Conductor Type	IP0 / -		

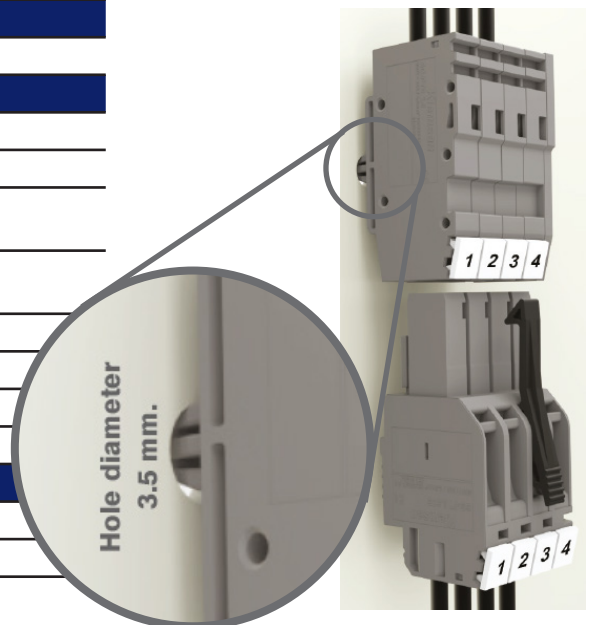

Ordering Codes <small>(please refer to IMO for availability)</small>			
■ GREY	SCP-HM2.5GREY	■ GREEN	SCP-HM2.5GREEN
■ RED	SCP-HM2.5RED*	■ YELLOW	SCP-HM2.5YELLOW*
■ BLACK	SCP-HM2.5BLACK*	□ WHITE	SCP-HM2.5WHITE*
■ BLUE	SCP-HM2.5BLUE*	■ ORANGE	SCP-HM2.5ORANGE*
Pack Size			
Quantity	50 Pcs		

### Accessories

Markers	Part Number
Blank Marker (white 5x5mm)	Contact IMO for further information
End Plate	EPSCPFH2.5COLOUR

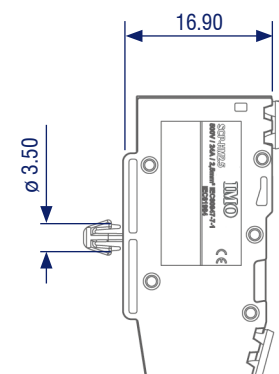

NOTE: Dimensions above are in mm

\* Supplied in grey & green as standard. For all other colours, minimum order quantities apply. Contact IMO for details.

# SCP-FM2.5 - Free Mounting Terminal

## SCP Series - 500V, 24A, 2.5mm<sup>2</sup> - Single Pole Modular

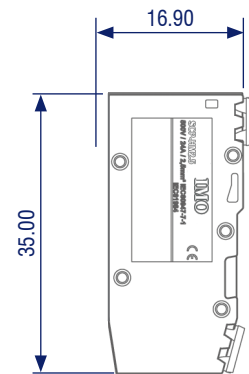
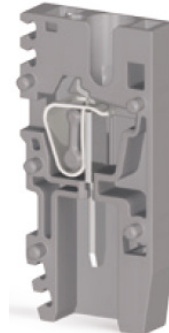

NOTE: Dimensions above are in mm

Dimensions & Weight			
Width	5.20mm		
Height (MR35x7.5)	35.00mm		
Length	16.90mm		
Net Weight	4.5g		
Electrical Ratings	Voltage V~	Current A	Cross-Section
UL	-	-	-
IEC	500V	24A	0.5-4mm <sup>2</sup>
IECEX	-	-	-
Flammability Rating			
UL94	V0		
Temperature			
Operating Temperature	-60°C to +130°C		
Connection Data			
Conductor Cross-Section Solid (min-max)	0.08-4mm <sup>2</sup>		
Conductor Cross-Section Stranded (min-max)	0.2-2.5mm <sup>2</sup>		
Conductor Cross-Section Stranded with Ferrules (min-max)	0.14-2.5mm <sup>2</sup>		
2 Conductors with same Cross-Section Stranded, Twin Ferrules with plastic sleeve	0.5mm <sup>2</sup>		
AWG Conductor	AWG 28-12		
Insulation Stripping Length (min-max)	8-10mm		
Connection in Acc. with Standard	IEC 60947-7-1		
Torque (min-max)	N/A		
Technical Data			
Rated Surge Voltage / Pollution Degree	6kV / 3		
Protection Class / Protection Conductor Type	IP0 / -		

Ordering Codes <small>(please refer to IMO for availability)</small>			
■ GREY	<b>SCP-FM2.5GREY</b>	■ GREEN	<b>SCP-FM2.5GREEN</b>
■ RED	<b>SCP-FM2.5RED*</b>	■ YELLOW	<b>SCP-FM2.5YELLOW*</b>
■ BLACK	<b>SCP-FM2.5BLACK*</b>	□ WHITE	<b>SCP-FM2.5WHITE*</b>
■ BLUE	<b>SCP-FM2.5BLUE*</b>	■ ORANGE	<b>SCP-FM2.5ORANGE*</b>
Pack Size			
Quantity	50 Pcs		

### Accessories

Markers	Part Number
Blank Marker (white 5x5mm)	Contact IMO for further information
End Plate	<b>EPSCPFH2.5COLOUR</b>

\* Supplied in grey & green as standard. For all other colours, minimum order quantities apply. Contact IMO for details.

# SCPEP2.5GREY

## End Plate for SCP Push-In Series



**Ordering Codes** *(please refer to IMO for availability)*

■ GREY	<b>SCPEP2.5GREY</b>	■ GREEN	<b>SCPEP2.5GREEN</b>
■ RED	<b>SCPEP2.5RED*</b>	■ YELLOW	<b>SCPEP2.5YELLOW*</b>
■ BLACK	<b>SCPEP2.5BLACK*</b>	□ WHITE	<b>SCPEP2.5WHITE*</b>
■ BLUE	<b>SCPEP2.5BLUE*</b>	■ ORANGE	<b>SCPEP2.5ORANGE*</b>
■ BEIGE	<b>SCPEP2.5BEIGE*</b>	■ BROWN	<b>SCPEP2.5BROWN*</b>

**Pack Size**

Quantity	50 Pcs
----------	--------

**Flammability Rating**

UL94	V0
------	----

**Construction**

Insulating Material	PA
---------------------	----

**Technical Data**

Continuous Operating Temperature Max.	130°C
Continuous Operating Temperature Min.	-60°C

**Dimensions**

Width	1.0mm
Length	51.4mm
Height	29.6mm

*\* Supplied in grey & green as standard. For all other colours, minimum order quantities apply. Contact IMO for details.*

# SCP-PT2.5/1 - Plug for SCP Terminal

SCP Series - 500V, 24A, 2.5mm<sup>2</sup> - Single Pole Non Modular



Dimensions & Weight			
Width	5.20mm		
Height (MR35x7.5)	41.90mm		
Length	17.80mm		
Net Weight	4.5g		
Electrical Ratings	Voltage V~	Current A	Cross-Section
UL	-	-	-
IEC	500V	24A	0.5-4mm <sup>2</sup>
IECEX	-	-	-
Flammability Rating			
UL94	V0		
Temperature			
Operating Temperature	-60°C to +130°C		
Connection Data			
Conductor Cross-Section Solid (min-max)	0.08-4mm <sup>2</sup>		
Conductor Cross-Section Stranded (min-max)	0.2-2.5mm <sup>2</sup>		
Conductor Cross-Section Stranded with Ferrules (min-max)	0.14-2.5mm <sup>2</sup>		
2 Conductors with same Cross-Section Stranded, Twin Ferrules with plastic sleeve	0.5mm <sup>2</sup>		
AWG Conductor	AWG 28-12		
Insulation Stripping Length (min-max)	8-10mm		
Connection in Acc. with Standard	IEC 60947-7-1		
Torque (min-max)	N/A		
Technical Data			
Rated Surge Voltage / Pollution Degree	6kV / 3		
Protection Class / Protection Conductor Type	IP0 / -		

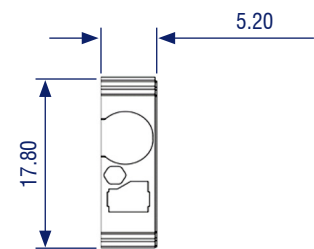
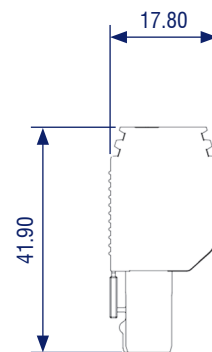

NOTE: Dimensions above are in mm

Ordering Codes <small>(please refer to IMO for availability)</small>			
■ GREY	SCP-PT2.5/1GREY	■ GREEN	SCP-PT2.5/1GREEN
■ RED	SCP-PT2.5/1RED*	■ YELLOW	SCP-PT2.5/1YELLOW*
■ BLACK	SCP-PT2.5/1BLACK*	□ WHITE	SCP-PT2.5/1WHITE*
■ BLUE	SCP-PT2.5/1BLUE*	■ ORANGE	SCP-PT2.5/1ORANGE*
Pack Size			
Quantity	50 Pcs		

### Accessories

Markers	Part Number
Blank Marker (white 5x5mm)	Contact IMO for further information

\* Supplied in grey & green as standard. For all other colours, minimum order quantities apply. Contact IMO for details.

# SCP-PT2.5/1L - Plug for SCP Terminal

SCP Series - 500V, 24A, 2.5mm<sup>2</sup> - Single Pole Modular, LHS

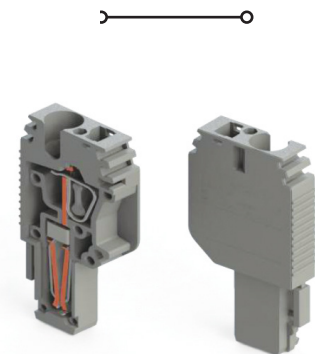

Dimensions & Weight			
Width	5.20mm		
Height (MR35x7.5)	41.90mm		
Length	17.80mm		
Net Weight	4.5g		
Electrical Ratings	Voltage V~	Current A	Cross-Section
UL	-	-	-
IEC	500V	24A	0.5-4mm <sup>2</sup>
IECEX	-	-	-
Flammability Rating			
UL94	V0		
Temperature			
Operating Temperature	-60°C to +130°C		
Connection Data			
Conductor Cross-Section Solid (min-max)	0.08-4mm <sup>2</sup>		
Conductor Cross-Section Stranded (min-max)	0.2-2.5mm <sup>2</sup>		
Conductor Cross-Section Stranded with Ferrules (min-max)	0.14-2.5mm <sup>2</sup>		
2 Conductors with same Cross-Section Stranded, Twin Ferrules with plastic sleeve	0.5mm <sup>2</sup>		
AWG Conductor	AWG 28-12		
Insulation Stripping Length (min-max)	8-10mm		
Connection in Acc. with Standard	IEC 60947-7-1		
Torque (min-max)	N/A		
Technical Data			
Rated Surge Voltage / Pollution Degree	6kV / 3		
Protection Class / Protection Conductor Type	IP0 / -		

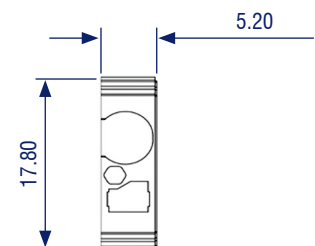
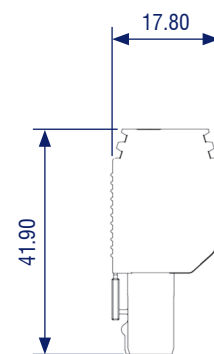

NOTE: Dimensions above are in mm

Ordering Codes			
<i>(please refer to IMO for availability)</i>			
■ GREY	SCP-PT2.5/1LGREY	■ GREEN	SCP-PT2.5/1LGREEN
■ RED	SCP-PT2.5/1LRED*	■ YELLOW	SCP-PT2.5/1LYELLOW*
■ BLACK	SCP-PT2.5/1LBLACK*	□ WHITE	SCP-PT2.5/1LWHITE*
■ BLUE	SCP-PT2.5/1LBLUE*	■ ORANGE	SCP-PT2.5/1LORANGE*
Pack Size			
Quantity	50 Pcs		

## Accessories

Markers	Part Number
Blank Marker (white 5x5mm)	Contact IMO for further information

\* Supplied in grey & green as standard. For all other colours, minimum order quantities apply. Contact IMO for details.

# SCP-PT2.5/1M - Plug for SCP Terminal

SCP Series - 500V, 24A, 2.5mm<sup>2</sup> - Single Pole Modular, Middle



Dimensions & Weight			
Width	5.20mm		
Height (MR35x7.5)	41.90mm		
Length	17.80mm		
Net Weight	4.5g		
Electrical Ratings	Voltage V~	Current A	Cross-Section
UL	-	-	-
IEC	500V	24A	0.5-4mm <sup>2</sup>
IECEX	-	-	-
Flammability Rating			
UL94	V0		
Temperature			
Operating Temperature	-60°C to +130°C		
Connection Data			
Conductor Cross-Section Solid (min-max)	0.08-4mm <sup>2</sup>		
Conductor Cross-Section Stranded (min-max)	0.2-2.5mm <sup>2</sup>		
Conductor Cross-Section Stranded with Ferrules (min-max)	0.14-2.5mm <sup>2</sup>		
2 Conductors with same Cross-Section Stranded, Twin Ferrules with plastic sleeve	0.5mm <sup>2</sup>		
AWG Conductor	AWG 28-12		
Insulation Stripping Length (min-max)	8-10mm		
Connection in Acc. with Standard	IEC 60947-7-1		
Torque (min-max)	N/A		
Technical Data			
Rated Surge Voltage / Pollution Degree	6kV / 3		
Protection Class / Protection Conductor Type	IP0 / -		

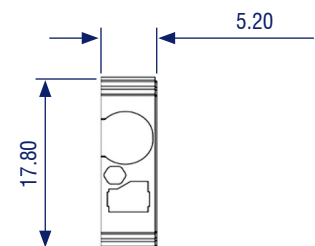
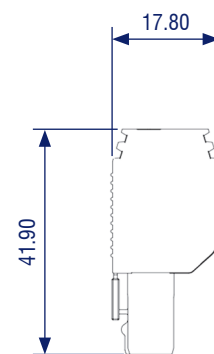
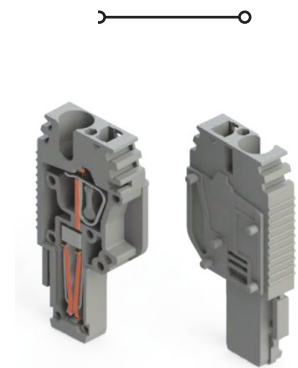

NOTE: Dimensions above are in mm

Ordering Codes			
<i>(please refer to IMO for availability)</i>			
■ GREY	SCP-PT2.5/1MGREY	■ GREEN	SCP-PT2.5/1MGREEN
■ RED	SCP-PT2.5/1MRD*	■ YELLOW	SCP-PT2.5/1MYELLOW*
■ BLACK	SCP-PT2.5/1MBLACK*	□ WHITE	SCP-PT2.5/1MWHITE*
■ BLUE	SCP-PT2.5/1MBLUE*	■ ORANGE	SCP-PT2.5/1MORANGE*
Pack Size			
Quantity	50 Pcs		

## Accessories

Markers	Part Number
Blank Marker (white 5x5mm)	Contact IMO for further information

\* Supplied in grey & green as standard. For all other colours, minimum order quantities apply. Contact IMO for details.



# SCP-PT2.5/1R - Plug for SCP Terminal

SCP Series - 500V, 24A, 2.5mm<sup>2</sup> - Single Pole Modular, RHS



Dimensions & Weight			
Width	5.20mm		
Height (MR35x7.5)	41.90mm		
Length	17.80mm		
Net Weight	4.5g		
Electrical Ratings	Voltage V~	Current A	Cross-Section
UL	-	-	-
IEC	500V	24A	0.5-4mm <sup>2</sup>
IECEX	-	-	-
Flammability Rating			
UL94	V0		
Temperature			
Operating Temperature	-60°C to +130°C		
Connection Data			
Conductor Cross-Section Solid (min-max)	0.08-4mm <sup>2</sup>		
Conductor Cross-Section Stranded (min-max)	0.2-2.5mm <sup>2</sup>		
Conductor Cross-Section Stranded with Ferrules (min-max)	0.14-2.5mm <sup>2</sup>		
2 Conductors with same Cross-Section Stranded, Twin Ferrules with plastic sleeve	0.5mm <sup>2</sup>		
AWG Conductor	AWG 28-12		
Insulation Stripping Length (min-max)	8-10mm		
Connection in Acc. with Standard	IEC 60947-7-1		
Torque (min-max)	N/A		
Technical Data			
Rated Surge Voltage / Pollution Degree	6kV / 3		
Protection Class / Protection Conductor Type	IP0 / -		

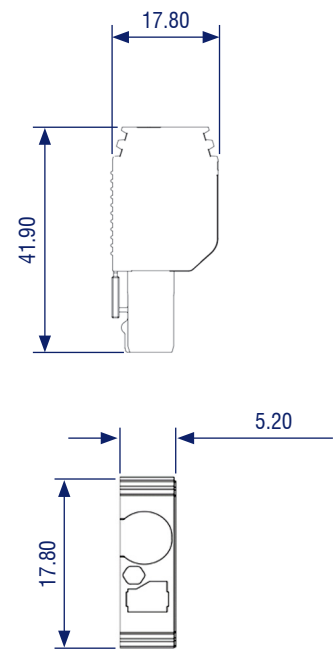

NOTE: Dimensions above are in mm

Ordering Codes <small>(please refer to IMO for availability)</small>			
■ GREY	SCP-PT2.5/1RGREY	■ GREEN	SCP-PT2.5/1RGREEN
■ RED	SCP-PT2.5/1RRED*	■ YELLOW	SCP-PT2.5/1RYELLOW*
■ BLACK	SCP-PT2.5/1RBLACK*	□ WHITE	SCP-PT2.5/1RWHITE*
■ BLUE	SCP-PT2.5/1RBLUE*	■ ORANGE	SCP-PT2.5/1RORANGE*
Pack Size			
Quantity	50 Pcs		

### Accessories

Markers	Part Number
Blank Marker (white 5x5mm)	Contact IMO for further information

\* Supplied in grey & green as standard. For all other colours, minimum order quantities apply. Contact IMO for details.