

i-PRO

WV-U65300-ZY WV-U65300-ZYG

U series PTZ camera

2MP (1080p) 3.1x Outdoor PTZ Network Camera

U-Series launch gives customers PTZ's that meet top security certifications (FIPS 140-2 level 3) while also providing a unique blend of imaging performance, reliability and affordability.

Highly durable pan-tilt drive unit Reduced maintenance costs

- PAN,TILT drive endurance (1 million movements) to reduce maintenance frequency.

Easy installation

- U-series compact PTZ cameras can be installed discreetly and easily on low ceilings.
- Easy kitting packaging allows the camera to be set up without removing it from the box during kitting prior to installation.
- U-series outdoor DOME x3.1 models have a structure that allows wiring and installation without opening the DOME, supporting easy installation in the field.
- The addition of a diverse lineup of mounting brackets and optional PoE injectors enables flexible installation regardless of the location of new or existing installations.

High security standard

- Highest level of security. In addition to digital certificates issued by a third-party organization (GlobalSign®), FIPS 140-2 level3-certified hardware is installed.

Key i-PRO Spec.

- 2MP (1080p) 1920x1080
- 3.1x optical zoom
- Intelligent Auto
- Super Dynamic 144dB
- Color night vision (0.001 to 0.01 lx) (G: 0.002 to 0.03 lx)
- IP66, IK10 certified
- ONVIF® Profile G / S / T *ONVIF is a trademark of ONVIF, Inc.
- FIPS 140-2 level3 certified

Industry examples

- Safe Cities
- Transportation(Airport / Train, Subway station)
- Parking
- Critical infrastructure



WV-U65300-ZY



WV-U65300-ZYG (Smoke Dome)



Specifications

Camera	Image Sensor	Approx. 1/2.8 type CMOS image sensor
	Minimum Illumination	Color : 0.01 lx (G: 0.03 lx) (50IRE, F1.3, 1/30s) Color : 0.001 lx (G: 0.002 lx) (50IRE, F1.3, 1/30s)*1 BW : 0.004 lx (G: 0.012 lx) (50IRE, F1.3, 1/30s) BW : 0.0003 lx (G: 0.0008 lx) (50IRE, F1.3, 1/30s)
	White Balance	ATW1 / ATW2 / AWC
	Shutter Speed	[60 fps Mode] 1/60 Fix to 1/10000 Fix, [30 fps/15 fps mode] 1/30 Fix to 1/10000 Fix [50 fps Mode] 1/50 Fix to 1/10000 Fix, [25 fps/12.5 fps mode] 1/25 Fix to 1/10000 Fix
	Intelligent Auto	On / Off
	Super Dynamic*2	On / Off, The level can be set in the range of 0 to 31.
	Dynamic Range	Max.144 dB (Super Dynamic : On, Level 31)
	Adaptive Black Stretch	The level can be set in the range of 0 to 255.
	Back light compensation / High light compensation	BLC (Back light compensation) / HLC (High light compensation) / Off The level can be set in the range of 0 to 31 (only when Super dynamic / Intelligent Auto : Off)
	Fog compensation	On / Off, The level can be set in the range of 0 to 8 (only when intelligent auto / auto contrast adjust : Off)
	Maximum gain (AGC)	The level can be set in the range of 0 to 11.
	Color/BW (ICR)	Off / On / Auto1 / Auto2 / Auto3 (SCC)
	Digital Noise Reduction	The level can be set in the range of 0 to 255.
	Video Motion Detection (VMD)	On / Off, 4 areas available
	Scene Change Detection (SCD)	On / Off, 1 areas available
	Audio Detection	On / Off
	AI Sound Classification	—
	AI Analytics	—
	Privacy Zone	On / Off, Up to 32 zones available
	VIQS	On / Off, Up to 8 zones available
Camera Title (OSD)	On / Off, Up to 40 characters (alphanumeric characters, marks)	
Focus Adjustment	Auto focus	
Lens	Optical zoom	3.1x (Motorized zoom / Motorized Focus)
	Extra zoom	Max. 4x (3.1 to 4x : When resolution is 1280 x 720)
	Focal length	2.9 - 9 mm [1/8 inches - 11/32 inches]
	Angular Field of View	Horizontal : 36° (TELE) - 113° (WIDE), Vertical : 20° (TELE) - 60° (WIDE) [4 : 3 mode] Horizontal : 26° (TELE) - 82° (WIDE), Vertical : 20° (TELE) - 60° (WIDE)
DORI	Maximum Aperture Ratio	1 : 1.3 (WIDE) - 1 : 2.5 (TELE)
	Focus range	0.3 m (11-13/16 inches) - ∞
	Detect (25ppm / 8ppf)	Wide: 25.4 m / 83.4 ft, Tele: 118.2 m / 387.7 ft
	Observe (62.5ppm / 19ppf)	Wide: 10.2 m / 33.4 ft, Tele: 47.3 m / 155.1 ft
System on Chip (SoC)	Recognize (125ppm / 38ppf)	Wide: 5.1 m / 16.7 ft, Tele: 23.6 m / 77.5 ft
	Identify (250ppm / 76ppf)	Wide: 2.5 m / 8.3 ft, Tele: 11.8 m / 38.8 ft
	Adjusting Angle	Ambarella CV25M Horizontal : 0 to +350°, Vertical : 0 to +90°, Yaw : 0°
	Pan/tilt	0 - +350°
Browser GUI	Panning Range	Manual: Approx. 0.065°/s - 150°/s Preset: Up to approx. 150°/s
	Panning Speed	Manual: Approx. 0.065°/s - 150°/s Preset: Up to approx. 150°/s
	Tilting Range	Operational 0 - +90°
	Tilting Speed	Manual: Approx. 0.065°/s - 150°/s Preset: Up to approx. 150°/s
	Preset Positions	256 positions
	Auto Mode	Auto pan/ Preset sequence/ Patrol
Network	Self Return	10 s/ 20 s/ 30 s/ 1 min/ 2 min/ 3 min/ 5 min/ 10 min/ 20 min/ 30 min/ 60 min
	Camera Control	Brightness, AUX On / Off
	Audio	Mic (Line) Input : On / Off Volume adjustment : Low / Middle / High Audio Output : On / Off Volume adjustment : Low / Middle / High
	GUI / Setup Menu Language	English, Italian, French, German, Spanish, Portuguese, Russian, Chinese, Japanese Browser*3
Network	Resolution	Microsoft Edge, Firefox, Google Chrome
	H.265/ H.264*5	10Base-T / 100Base-TX, RJ45 connector
	JPEG	[16 : 9 mode (60 fps mode)]*2, [16 : 9 mode (30 fps mode)], [16 : 9 mode (50 fps mode)]*2, [16 : 9 mode (25 fps mode)] 1920x1080, 1280x720, 640x360, 320x180 [4 : 3 mode (30 fps mode)], [4 : 3 mode (25 fps mode)] 1280x960, VGA, QVGA [4 : 3 mode (15 fps mode)], [4 : 3 mode (12.5 fps mode)] 2048x1536*4, 1280x960, VGA, QVGA
	Image Quality	Constant bit rate / VBR / Frame rate / Best effort Unicast port (AUTO) / Unicast port (MANUAL) / Multicast 10 steps

Network	Smart Coding	GOP (Group of pictures) control: Off / Low (Variable GOP 1s-8s) / Mid (Variable GOP 4s-16s) / Advanced (Fixed GOP 60s w/1s key-frame) / Frame rate control (Variable GOP 4s-16s with frame rate control) *Advanced and Frame rate control are only available with H.265. Smart Coding: Auto VIQS: On/Off
	Audio Compression	G.726 (ADPCM) : 16 kbps / 32 kbps G.711 : 64 kbps AAC-LC*6 : 96 kbps / 128 kbps
Audio transmission mode	Supported Protocol	Off / Mic (Line) input / Audio output / Interactive (Half duplex) / Interactive (Full duplex)
	No. of Simultaneous Users	Up to 14 users (Depends on network conditions)
Secure	Secure	FIPS 140-2 level3, Device Certificate GlobalSign® pre-installed
	SDXC/SDHC/SD Memory Card	H.265 / H.264 recording : Manual REC / Alarm REC (Pre/Post) / Schedule REC / Backup upon network failure JPEG recording : Manual REC / Alarm REC (Pre/Post) / Backup upon network failure Compatible SDXC/SDHC/SD Memory Card : microSDXC memory card : 64 GB, 128 GB, 256 GB, 512 GB microSDHC memory card : 4 GB, 8 GB, 16 GB, 32 GB microSD memory card : 2 GB
	Mobile Terminal Compatibility	iPad, iPhone (iOS 8.0 or later), Android™ terminals
	ONVIF® Profile	G / S / T
Alarm	Alarm Source	3 terminals input, VMD alarm, Command alarm, Audio detection alarm
	Alarm Actions	SDXC/SDHC/SD memory recording, E-mail notification, HTTP alarm notification Indication on browser, TCP alarm notification output
Input/ Output	Audio input	For microphone input : ø3.5 mm stereo mini jack Recommended applicable microphone : Plug-in power type (Sensitivity of microphone : -51 dB to -38 dB (0 dB=1 V/Pa, 1 kHz)) Input impedance : Approx. 2 kΩ (unbalanced) Supply voltage : 2.5 V ±0.5 V For line input : Input level : Approx. -10 dBV
	Audio Output	ø3.5 mm stereo mini jack (monaural output) Output impedance : Approx. 600 Ω (unbalanced) Output level : -20 dBV
External I/O Terminals	External I/O Terminals	ALARM IN 1 (Alarm input 1/ Black & white input/ Auto time adjustment input) (x1) ALARM IN 2 (Alarm input 2/ ALARM OUT) (x1), ALARM IN 3 (Alarm input 3/ AUX OUT) (x1)
	General	Safety UL (UL62368-1), c-UL (CSA C22.2 No.62368-1), CE, IEC62368-1 EMC FCC (Part15 ClassA), ICES-003 Issue 7 ClassA, EN55032 ClassA, EN55035 Power Source and Power Consumption DC12 V, PoE (IEEE802.3af) DC12 V: 890 mA / Approx. 10.7 W PoE DC 48 V: 250 mA / Approx.12.0 W (Class 0 device) Ambient Operating Temperature -30 °C to +55 °C (-22 °F to +131 °F) (Power On range : -20 °C to +55 °C (-4 °F to +131 °F)) Maximum temperature according to NEMA TS2(2.2.7) : 74 °C(165°F) Ambient Operating Humidity 10 to 100 % (no condensation) Anti-Condensation System Temish element Water and Dust Resistance IP66, IEC60529 measuring standard compatible, Type 4X(UL50E), NEMA 4X compliant Shock Resistance IK10 (IEC 62262) Other standard support NEMA TS2(2.2.7-2.2.9) Dimensions ø155 mm x 134 mm (H) [ø6-3/32 inches x 5-9/32 inches (H)] Mass (approx.) Approx. 1.6 kg (3.53 lbs.) Finish Main body : Aluminum die cast and polycarbonate resin, i-PRO white Dome section : Polycarbonate resin, Clear (G: Smoke)

*1 Converted value
*2 When 60 fps or 50 fps is selected, the Super Dynamic function is automatically set to off.
*3 For information on the operation verification of the supported web browsers, refer to our support website <Control No.: C0132>.
*4 Used by super resolution techniques
*5 Transmission for 4 streams can be individually set.
*6 When recording audio on a microSD memory card, only use AAC-LC (Advanced Audio Coding - Low Complexity).

Appearance

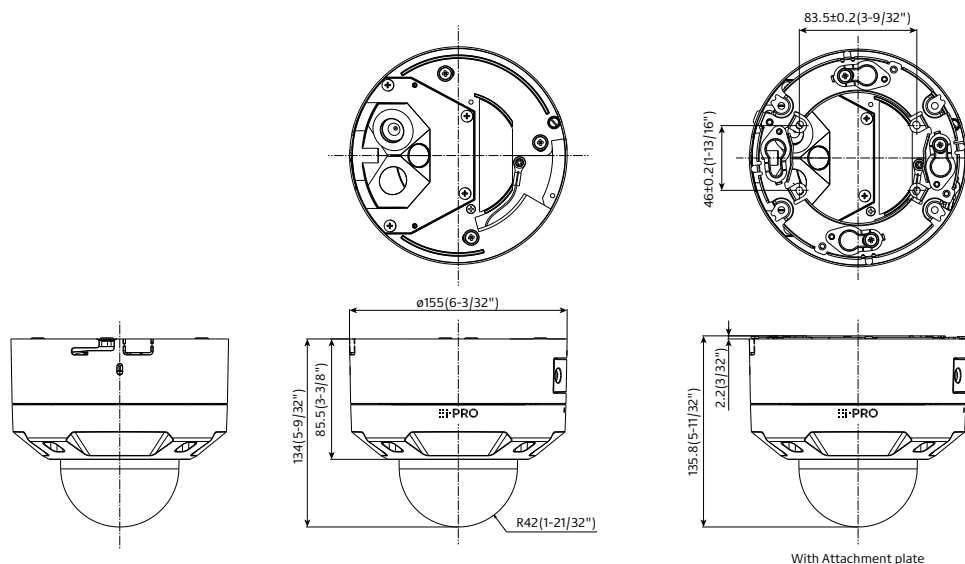













Unit : mm (inches)







With Attachment plate

Optional Accessories

Mount Bracket / Other

combination	WALL		POLE	CORNER	HANGING	
	1	2	1	1	1	2
	Wall Mount Bracket WV-QWL501-W (i-PRO white) 	Wall Mount Bracket WV-QWL500-W (i-PRO white) 	Pole Mount Bracket WV-QPL500-W (i-PRO white) 	Corner Mount Bracket WV-QCN500-W (i-PRO white) 	Ceiling Mount Bracket WV-QCL501-W (i-PRO white) 	Ceiling Mount Bracket WV-QCL100-W *1 (i-PRO white)  *For indoor installation only.
Mount Bracket WV-QSR501-W (i-PRO white) 	Adapter Box WV-QJB500-W (i-PRO white)  *if needed.	Wall Mount Bracket WV-QWL501-W (i-PRO white) 	Wall Mount Bracket WV-QWL501-W (i-PRO white) 	Mount Bracket WV-QSR501-W (i-PRO white) 		
		Mount Bracket WV-QSR501-W (i-PRO white) 	Mount Bracket WV-QSR501-W (i-PRO white) 			

*1: It's possible to be used on the camera side and ceiling side. If used on both side, 2pieces are required.

combination	CEILING			OTHER
	1	2	3	1
	Base Bracket WV-QJB501-W (i-PRO white) 	Ceiling Mount Bracket (Embedded) WV-QEM502-W (i-PRO white)  *For indoor installation only.	Base bracket WV-QJB504-W (i-PRO white) 	3rd Party Pipe (Male or Female type)
			Mount Bracket WV-QSR501F-W (i-PRO white, ISO Female thread)  WV-QSR501M-W (i-PRO white, ISO Male thread) 	Mount Bracket WV-QSR501F1-W (White, ANSI Female thread)  WV-QSR501M1-W (White, ANSI Male thread) 

Dome Cover

Dome Cover (Smoke type) WV-CW7S 	Dome Cover (Smoke type with ClearSight coating) WV-CW7SN 	Dome Cover (Clear type with ClearSight coating) WV-CW7CN 
---	--	--

Cable

I/O Cable WV-QCA501A WV-QCA501APK 
--

*WV-QCA501APK is package of 10 cables.

*The color of the grommet rubber may differ depending on the production time, but the performance and mounting method will not change.

Trademarks and registered trademarks

- GlobalSign and the GlobalSign Logo are registered trademarks of GMO GlobalSign K.K.
- iPad and iPhone are trademarks of Apple Inc., registered in the U.S. and other countries.
- Android is a trademark of Google LLC.
- ONVIF is a trademark of ONVIF, Inc.
- All other trademarks identified herein are the property of their respective owners.

Important

- Safety Precautions : Carefully read the Basic Information, Installation Guide and Operating Instructions before using this product.
- i-PRO Co., Ltd. cannot be held responsible for the performance of the network and/or other manufacturers' products used on the network.
- Masses and dimensions are approximate. • Specifications are subject to change without notice.