



CorePro LED PLC 2P



CorePro LED PLC 8.5W 840 2P G24d-3

The CorePro LED PLC 2P integrates a LED light source into a traditional fluorescent form factor. This product is the ideal solution for uplamping in general lighting applications: it meets basic lighting requirements, offers significant energy savings and is environmentally friendly.

Product data

General information	
Cap base	G24D-3 [G24d-3]
Nominal lifetime	30,000 h
Switching Cycle	50,000
Lighting Technology	LED
Flux measurement reference	Sphere
Light technical	
Colour Code	840 [CCT of 4000K]
Beam angle (nom.)	120 degree(s)
Luminous Flux	1,000 lm
Colour designation	Cool White (CW)
Correlated Colour Temperature	4000 K
Luminous Efficacy (rated) (Nom)	105.88 lm/W
Colour consistency	<6
Colour rendering index (CRI)	83
LLMF at end of nominal lifetime (nom.)	70 %
Operating and electrical	
Line Frequency	50 to 60 Hz
Input frequency	50 to 60 Hz
Power Consumption	8.5 W
Starting time (nom.)	0.5 s

Warm-up time to 60% light	0.5 s
Power Factor (Fraction)	0.9
Voltage (nom.)	220-240 V
Temperature	
Ambient temperature range	-20 °C to 35 °C
T-Case maximum (nom.)	75 °C
Controls and dimming	
Dimmable	No
Mechanical and housing	
Bulb material	Plastic
Product length	200 mm
Bulb shape	Tube, single-ended
Approval and application	
Energy Efficiency Class	F
Energy-saving product	Yes
Approval marks	TUV CE marking RoHS compliance KEMA Keur certificate
Energy consumption kWh/1,000 hours	9 kWh
EPREL registration number	403555

CorePro LED PLC 2P

CE mark	Yes
EU RoHS compliant	Yes
Product data	
Full EOC	871869654125800
Order product name	CorePro LED PLC 8.5W 840 2P G24d-3
Order code	54125800

SAP numerator – quantity per pack	1
Numerator – packs per outer box	10
Material number (12NC)	929001201302
Full product name	CorePro LED PLC 8.5W 840 2P G24d-3
EAN/UPC - Case	8718696541265

Dimensional drawing

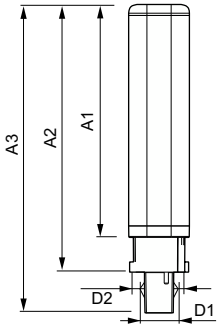

Product	D1	D2	A1	A2	A3
CorePro LED PLC 8.5W 840 2P G24d-3	24.3 mm	28.4 mm	128.8 mm	148 mm	170.6 mm

Photometric data

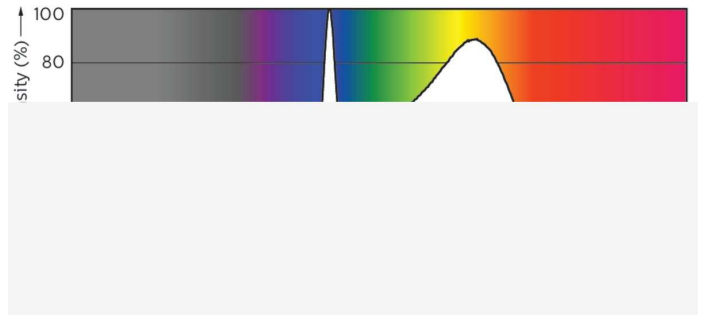
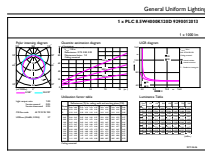

General uniform lighting - CorePro LED PLC 8.5W 840 2P G24d-3

Spectral Power Distribution Colour - CorePro LED PLC 8.5W 840 2P G24d-3

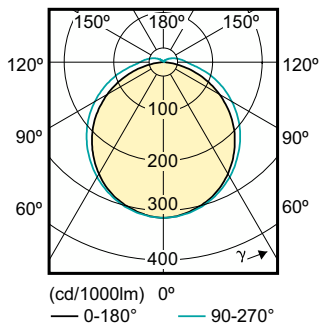

Light Distribution Diagram - CorePro LED PLC 8.5W 840 2P G24d-3

CorePro LED PLC 2P

Lifetime

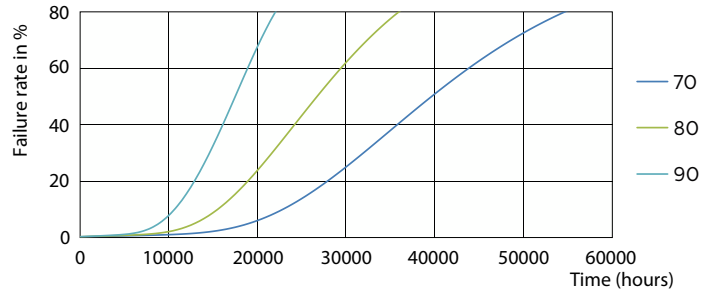
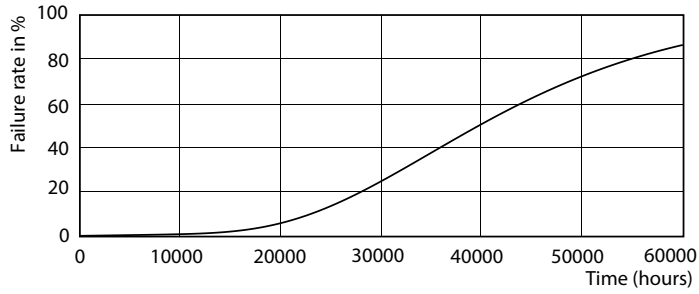

Life Expectancy Diagram - CorePro LED PLC 8.5W 840 2P G24d-3



Life Expectancy Diagram - CorePro LED PLC 8.5W 840 2P G24d-3

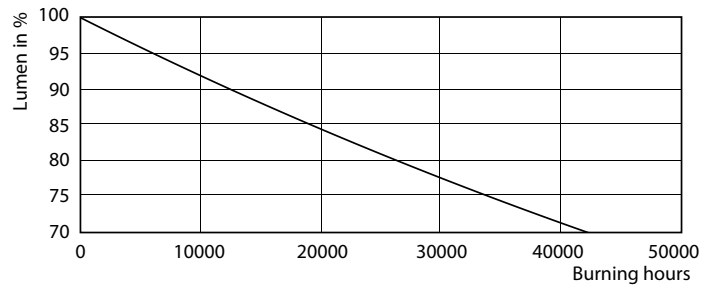

Life Expectancy Diagram - CorePro LED PLC 8.5W 840 2P G24d-3

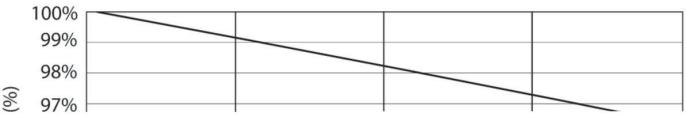

Lumen Maintenance Diagram - CorePro LED PLC 8.5W 840 2P G24d-3

Lumen Maintenance Diagram - CorePro LED PLC 8.5W 840 2P G24d-3

CorePro LED PLC 2P

